



SACHS is a
brand of ZF



2015 | 2016



EURO6

Kupplungen für Nfz

Neu: Mit Euro6 Teilen

Clutches for CV

New: Including Euro6 Parts

DE EN

FR ES

PT IT

NL NO

SV FI

PL RU

HU CS

RO HR

EL TR

ZH



SACHS

	DE	FR	PT	NL	SV
	EN	ES	IT	NO	FI
	Produkte Products	Produits Productos	Produtos Prodotti	Producten Produkter	Produkter Tuotteet
	Kit plus CSC Kit plus CSC	Kit plus CSC Kit plus CSC	Kit plus CSC Kit plus CSC	Kit plus CSC Kit plus CSC	Kit plus CSC Kit plus CSC
	Kupplungssatz Clutch kit	Kit d'embrayage Kit de embrague	Conjunto de embreagem Kit frizione	Koppelingsset Clutchset	Kopplingsatts Kytkinpaketti
	Druckplatte Pressure plate	Mécanisme d'embrayage Plato de presión	Placa de pressão Spingidisco	Drukgroep Trykkplate	Tryckplatta Kytkinasennelma
	Kupplungsscheibe Clutch disc	Disque d'embrayage Disco de embrague	Disco de embreagem Disco frizione	Koppelingsplaat Clutchlamell	Kopplingsskiva Kytkinlevy
	Torsionsdämpfer Torsion damper	Amortisseur de torsion Amortiguador de torsión	Amortecedores da rotação Smorzatore torsionale	Torsiedemper Torsjonsdemper	Torsionsdämpare Vääntövaimennin
	Ausrücker Releaser	Butée Dispositivo de desembrague	Dispositivo de desengate Cuscinetto reggispinta	Koppelingsdruklager Utløser	Urtrampningsdon Irrotin
	Haltefeder Retaining spring	Ressort de retenue Muelle de retención	Mola de fixação Molla di fermo	Steuerveer Holdefjær	Låsfjäder Lukitusjousi
	Führungslager Pilot bearing	Palier de guidage Cojinete guía	Rolamento de guia Cuscinetto di guida	Geleidingslager Styrelager	Styrlager Ohjainlaakeri
	Schraubensatz Bolt kit	Jeu de vis Kit de tornillos	Conjunto de parafusos Kit viti	Boutenset Skruesett	Bultsats Ruuvisarja
	Zweimassenschwungrad Dual-mass flywheel	Volant bimasse Volante bimasa	Volante de inércia de dupla massa Volano a doppia massa	Tweemassavliegwiel Todelt svinghjul	Tväämassesvånghjul Kaksimassavauhtipyörä
	Zwischenring Intermediate ring	Bague intermédiaire Anillo intermedio	Anel intermediário Anello intermedio	Tussenring Mellomring	Mellanläggsbricka Välpainelevy
	Montagesatz Assembly kit	Kit de montage Kit de montaje	Kit de montagem Kit di montaggio	Montageset Monteringssett	Monteringsatts Asennussarja
	Zentralausrücker (CSC) Concentric slave cylinder (CSC)	Butée Hydraulique (CSC) Dispositivo de desembrague (CSC)	Dispositivo central de engate (CSC) Cuscinetto reggispinta coassiale (CSC)	Centrale releaser (CSC) Sentralutløser (CSC)	Centralt urtrampningsdon (CSC) Irrotinlaakeri-työsynteriyhdistelmä (CSC)
	Geberzylinder Master cylinder	Cylindre émetteur Cilindro principal	Cilindro mestre Pompa idraulica	Commandocylinder Hovedsyylinder	Huvudcylinder Pääsynteri
	Nehmerzylinder Slave cylinder	Cylindre récepteur Cilindro receptor	Cilindro escravo Cilindro ricevitore	Werkcilinder Arbeidssylinder	Slavcylinder Työsynteri
	Kupplungsseil Clutch cable	Câble d'embrayage Cable del embrague	Cabo de embreagem Cavo della frizione	Koppelingskabel Clutchvaier	Kopplingsvajer Kytkinvaajeri
	Produktinweise Product information	Indications de produit Indicaciones del producto	Indicações do produto Indicazioni prodotto	Productinstructies Produktinformasjon	Produktanvisningar Tuoteohjeet
	Nur als Satz lieferbar Only available as kit	Uniquement disponible en kit Solo disponible como kit	Disponível apenas como conjunto Disponibile solo come kit	Alleen als set leverbaar Leveres kun som sett	Levereras bara som sats Saatavilla vain sarjana
	Ausrücker montiert mit Druckplatte Releaser fitted to the cover assembly	Butée montée sur le plateau de pression Dispositivo de desembrague incorporado en el plato de presión	Dispositivo de desengate montado como placa de pressão Cuscinetto reggispinta montato con spingidisco	Releaser gemonteerd in drukgroep Utløserlager monteret på trykkplate	Monterat urtrampningsdon med tryckplatta Irrotin asennettu kytkinasennelman kanssa
	Ohne Ausrücker Without releaser	Sans butée Sin dispositivo de desembrague	Sem dispositivo de desengate Senza cuscinetto reggispinta	Zonder koppelingsdruklager Uten utløser	Utan urtrampningsdon Ilman irrotinta
	Auslaufartikel Article to be discontinued	Article jusqu'à épuisement Hasta agotar existencias	Artigo descontinuado Articolo fuori produzione	Artikel in uitloop Utgått artikkel	Utgående artikel Tuotteen valmistus lopetettu
	Wahlweise Alternatively	Alternative Opcional	Opcionalmente A scelta	Naar keuze Alternativt	Alternativt Valinnaisesti
	Verstärkte Ausführung Heavy duty version	Modèle renforcé Versión reforzada	Versão reforçada Versione rinforzata	Versterkte uitvoering Forsterket utførelse	Förstärkt modell Vahvistettu malli
	Austauschteil Remanufactured part	Élément de rechange Pieza reacondicionada	Peça remanufaturada Componente intercambiabile	Gereviseerd onderdeel Byttedel	Reservdel Vaihdeosa

	DE	FR	PT	NL	SV
	EN	ES	IT	NO	FI
	Fahrzeuginweise Vehicle information	Indications de véhicule Indicaciones del vehículo	Indicações sobre o veículo Indicazioni veicolo	Voertuigaanwijzingen Kjøretøyhenvisning	Fordonsanvisningar Ajoneuvo-ohjeet
	Mit Schaltgetriebe With manual transmission	Avec boîte de vitesses manuelle Con caja de cambios	Com caixa de câmbio manual Con cambio manuale	Met handgeschakelde versnellingsbak Med manuell girkasse	Med växellåda Manuaalivaihteistolla
	Mit Schaltgetriebe 5 Gang With manual transmission 5-speed	Avec boîte de vitesses manuelle à 5 vitesses Con caja de cambios de 5 marchas	Com caixa de câmbio manual 5 marchas Con cambio a 5 marce	Met handgeschakelde versnellingsbak 5 versnellingen Med manuell girkasse 5-trinns	Manuell 5-växlad låda Käsivaihteistolla 5-vaihteinen
	Mit Schaltgetriebe 6 Gang With manual transmission 6-speed	Avec boîte de vitesses manuelle à 6 vitesses Con caja de cambios de 6 marchas	Com caixa de câmbio manual 6 marchas Con cambio a 6 marce	Met handgeschakelde versnellingsbak 6 versnellingen Med manuell girkasse 6-trinns	Manuell 6-växlad låda Käsivaihteistolla 6-vaihteinen
	Bestückungswechsel Fitting change	Remplacement des composants Cambio de equipamiento	Substituição de equipamento Sostituzione equipaggiamento	Uitrustingswissel Skifte av utstyr	Monteringsbyte Varustuksen vaihto
1888 055 247	Komplettbestückung Complete fitting	Ensemble des composants Equipamiento completo	Montagem completa Equipaggiamento completo	Complete uitrusting Komplett utstyr	Komplettmontering Kokonaisvarustus
	Getriebeseitig Transmission side	Côté transmission Lado de la caja de cambios	Do lado da caixa de câmbio Lato trasmissione	Versnellingsbakzijde Girside	På växellådan Vaihteistonpuoleinen
	Motorseitig Engine side	Côté moteur Lado del motor	Do lado do motor Lato motore	Motorzijde Motorside	På motorn Moottorinpuoleinen
	Für Linkslenker For left-hand drive vehicles	Pour véhicules avec direction à gauche Para volante a la izquierda	Para volante do lado esquerdo Per veicoli con guida a sinistra	Voor linksgestuurde voertuigen For venstreratt	För vänsterstyrning Vasemmanpuoleinen ohjaus
	Für Rechtslenker For right-hand drive vehicles	Pour véhicules avec direction à droite Para volante a la derecha	Para volante do lado direito Per veicoli con guida a destra	Voor rechtsgestuurde voertuigen For høyreratt	För högerstyrning Oikeanpuoleinen ohjaus
	Spalte i Column i	Colonne i Columna i	Coluna i Colonna i	Kolom i Spalte i	Spalt i Sarake i
Chass. ...	Fahrgestellnummer Chassis number	Numéro de châssis Número de chasis	Número do chassis Numero di telaio	Chassisnummer Chassisnummer	Chassinummer Alustanumero
->Chass. ...	Bis Fahrgestellnummer To chassis number	Jusqu'au numéro de châssis Hasta número de chasis	Até ao número do chassis Fino al numero di telaio	Tot chassisnummer Til chassisnummer	Till chassinummer Päätyen alustanumeroon
Chass. ...->	Ab Fahrgestellnummer From chassis number	À partir du numéro de châssis Desde número de chasis	A partir do número do chassis Da numero di telaio	Vanaf chassisnummer Fra chassisnummer	Från chassinummer Alkaen alustanumerosta
->02.2005	Bis Baujahr To construction year	Jusqu'à l'année de fabrication Hasta año de construcción	Até ao ano de fabricação Fino all'anno di costruzione	Tot bouwjaar Til produksjonsår	Till tillverkningsår Päätyen valmistusvuoteen
03.2005->	Ab Baujahr From construction year	À partir de l'année de fabrication Desde año de construcción	A partir do ano de fabricação Da anno di costruzione	Vanaf bouwjaar Fra produksjonsår	Från tillverkningsår Alkaen valmistusvuodesta
GBox ...	Getriebetyp Transmission type	Type de transmission Tipo de caja de cambios	Tipo de transmissão Tipo di trasmissione	Transmissietype Girtype	Växeltyp Vaihteistotyyppi
XTend	Mit automatischer Nachstellung With automatic adjustment	Avec ajustement automatique Con ajuste automático	Com ajuste automático Con regolazione automatica	Met automatische nastelling Med automatisk justering	Med automatisk justering Automaattisella säädöllä









PL
RU

HU
CS

RO
HR

EL
TR

ZH

Informacje o pojeździe Указания по автомобилю	Járműinformációk Pokyny týkající se vozidla	Indicații despre vehicul Napomene uz vozilo	Υποδείξεις οχήματος Taşıt uyarıları	车辆说明	
Z mechaniczną skrzynią biegów С механической коробкой передач	Sebességváltóval S převodovkou	Cu cutie de viteze manuală S ručnim mjenjačem	Με μηχανικό κιβώτιο ταχυτήτων Manuel şanziman ile	带变速箱	
Z 5-biegową mechaniczną skrzynią biegów С 5-ступенчатой механической коробкой передач	5 sebességes sebességváltóval S 5-ti stupňovou převodovkou	Cu cutie de viteze manuală cu 5 trepte S 5-stupanjskim ručnim mjenjačem	Με μηχανικό κιβώτιο 5 ταχυτήτων Manuel şanzimanlı, 5 vitesli	5 档手动变速箱	
Z 6-biegową mechaniczną skrzynią biegów С 6-ступенчатой механической коробкой передач	6 sebességes sebességváltóval S 6-ti stupňovou převodovkou	Cu cutie de viteze manuală cu 6 trepte S 6-stupanjskim ručnim mjenjačem	Με μηχανικό κιβώτιο 6 ταχυτήτων Manuel şanzimanlı, 6 vitesli	6 档手动变速箱	
Wymiana uzbrojenia Смена комплектующих	Felszerelésváltás Výměna osazení	Schimbare echipare Izmjena sastavnica	Αλλαγή εξοπλισμού Donanım değiştirme	完全配备	
Kompletne wyposażenie Комплектное оснащение	Komplett felszerelés Kompletní osazení	Echipare completă Kompletno opremanje	Πλήρης εξοπλισμός Komple donanım	完全装备	1888 055 247
Po stronie skrzyni biegów Со стороны коробки передач	Hajtásoldali Strana převodu	Pe partea cutiei de viteze Na strani mjenjača	Αφορά στο κιβώτιο ταχυτήτων Şanziman tarafı	变速箱侧	
Po stronie silnika Со стороны двигателя	Motoroldali Na straně motoru	Pe partea motorului Sa strane motora	Από την πλευρά του κινητήρα Motor tarafı	发动机侧	
Do ruchu lewostronnego Для автомобилей с левым расположением руля	Balkormányos járművekhez Pro vozidla s levostranným řízením	Pentru vehicule cu volan pe partea stângă Za vozila s upravljačem na lijevoj strani	Για αριστεροτίμονα Soldan direksiyonlular için	用于左侧驾驶车辆	
Do ruchu prawostronnego Для автомобилей с правым расположением руля	Jobbkormányos járművekhez Pro vozidla s pravostranným řízením	Pentru vehicule cu volan pe partea dreaptă Za vozila s upravljačem na desnoj strani	Για δεξιοτίμονα Sağdan direksiyonlular için	用于右侧驾驶车辆	
Kolumna i Столбец i	i oszlop Stoupec i	Coloana i Stupac i	Στήλη i i sütunu	i 栏	
Numer nadwozia Номер шасси	Alvázsámrv Číslo podvozku	Serie de şasiu Broja šasije	Αριθμός πλαισίου Şasi numarası	底盘号码	Chass. ...
Do numeru nadwozia До номера шасси	Alvázsámrig Do čísla podvozku	Până la seria de şasiu Do broja šasije	Μέχρι αριθμό πλαισίου Şasi numarasına kadar	至底盘号码	->Chass. ...
Od numeru nadwozia Начиная с номера шасси	Alvázsámrtól Od čísla podvozku	Începând de la seria de şasiu Od broja šasije	Από αριθμό πλαισίου Şasi numarasından itibaren	从底盘号码	Chass. ...->
Do roku produkcji До года изготовления	Gyártási évig Do roku výroby	Până în anul de fabricație Do godine proizvodnje	Μέχρι έτος κατασκευής Model yılına kadar	至制造年份	->02.2005
Od roku produkcji Начиная с года изготовления	Gyártási évtől Od roku výroby	Începând cu anul de fabricație Od godine proizvodnje	Από έτος κατασκευής Minimum model yılı	从制造年份	03.2005->
Typ skrzyni biegów Тип коробки передач	Sebességváltó típus Typ převodovky	Tip cutie de viteze Tip mjenjača	Τύπος κιβωτίου ταχυτήτων Şanziman tipi	变速箱类型	GBox ...
Z automatycznym nastawianiem С автоматической регулировкой	Automatikus utánállítással S automatickým nastavením	Cu reajustare automată S automatskim podešavanjem	Με αυτόματη ρύθμιση Otomatik ayarlarla ile	带自动调整	XTend

PL	HU	RO	EL	ZH	
RU	CS	HR	TR		
Продукты Produkty	Termékek Produkty	Produse Proizvodi	Προϊόντα Ürünler	产品	
Kit plus CSC Kit plus CSC	Kit plus CSC Kit plus CSC	Kit plus CSC Kit plus CSC	Kit plus CSC Kit plus CSC	Kit plus CSC	
Zestaw sprzęgła Комплект сцепления	Kuplungkészlet Spojková sada	Set de ambreiaj Komplet spojki	Σετ συμπλέκτη Debriyaj seti	离合器套件	
Płytką dociskowa Нажимной диск	Nyomólap Přítlačná deska	Placă de presiune Potisna ploča	Πλατό Baski plakası	压盘总成	
Tarcza sprzęgła Ведомый диск сцепления	Kuplungtárcsa Kotouč spojky	Disc de ambreiaj Disk spojke	Δίσκος συμπλέκτη Debriyaj diski	离合器从动盘	
Tłumik drgań skrętnych Гаситель крутильных колебаний	Torziós csillapító Torzní tlumič	Amortizor de torsiune Torzijski ublaživač	Αποσβεστήρας στρέψης Torsiyon söndümlerici	扭振减振器	
Wyrzęgtnik Выжимной подшипник	Kinyomócsapágy Vypínací ústrojí	Dispozitiv de debreiere Isključivač	Έδρανο αποσύμπλεξης Debriyaj rulmanı	分离轴承	
Sprężyna ustalająca Удерживающая пружина	Tartórugó Přidržná pružina	Arc de reținare Přidržna opruga	Ελατήριο συγκράτησης Tutma klipsi	止动弹簧	
Łożysko jezdne Центрирующий подшипник	Vezetőcsapágy Vodící ložisko	Lagăr de ghidare Vodečí ležaj	Έδρανο οδηγός Kılavuz yatak	导向轴承	
Zestaw śrub Комплект винтов	Csavarkészlet Sada šroubů	Set de șuruburi Komplet vijaka	Σετ βιδών Civata seti	螺栓套件	
Podwójne koło zamachowe Двухмассовый маховик	Kettős tömegű lendkerék Dvouhmotový setrvačnik	Volantă cu masă dublă Dvomasen zamašnjak	Σφόνδουλος διπλης μάζας Çift kütleli volan	双质量飞轮	
Pierścień pośredni Прокладочное кольцо	Kőzbenső gyűrű Vložený kroužek	Inel intermediar Međuprsten	Ενδιάμεσος δακτύλιος Ara halkası	间隔环	
Zestaw montażowy Монтажный комплект	Szerelőkészlet Montážní sada	Set de montaj Komplet za ugradnju	Σετ συναρμολόγησης Montaj seti	安装套件	
Centralny wyrzęgtnik (CSC) Муфта выключения (CSC)	Kőzponti kinyomócsapágy (CSC) Koncentrický pracovní válec (CSC)	Dispozitiv central de debreiere (CSC) Središnji isključivač (CSC)	Κεντρικό έδρανο αποσύμπλεξης (CSC) Merkezi debriyaj rulmanı (CSC)	液压分离轴承	
Pompa sprzęgłowa Главный цилиндр	Elsődleges kuplunghengere Hlavní válec	Pompă de ambreiaj Glavni cilindar	Εντολοδότης κύλινδρος Debriyaj merkezi	主泵	
Cylinder odbiorczy Рабочий цилиндр	Másodlagos kuplunghengere Pracovní válec	Cilindru receptor de ambreiaj Radni cilindar	Εντολοδόχος κύλινδρος Alt debriyaj merkezi	分泵	
Linka sprzęgła Трос привода сцепления	Kuplungbowden Lanovod spojky	Cablu de ambreiaj Uže spojke	Ντίτζα συμπλέκτη Debriyaj teli	离合器拉索	
Informacje o produkcie Указание к изделию	Termékre vonatkozó útmutatások Poznámky k výrobku	Indicații pentru produs Napomene o proizvodu	Υποδείξεις προϊόντος Ürün bilgileri	产品说明	
Dostarczany tylko w komplecie Поставляется только в комплекте	Csak készletként szállítható Dodává se pouze v sadě	Se livrează numai ca set Isporučiv samo u kompletu	Παραδοτέο μόνο ως σετ Sadece set olarak sipariş edilebilir	仅作为组件供货	
Wyrzęgtnik zamontowany z płytą dociskową Выжимной подшипник смонтирован вместе с нажимным диском	Kinyomócsapágy nyomólappal Vypínací ústrojí montováno s přítlačným kotoučem	Dispozitiv de debreiere montat cu placă de presiune Isključivač ugrađen sa potisnom pločom	Έδρανο αποσύμπλεξης τοποθετημένο με πλατό Debriyaj rulmanı plakası ile monte edildi	安装于压盘上的分离轴承	
Bez wyrzęgtnika Без выжимного подшипника	Kinyomócsapágy nélkül Bez vypínacího ústrojí	Fără dispozitiv de debreiere Bez isključivača	Χωρίς εξάρτημα αποσύμπλεξης Debriyaj rulmanı yok	无分离轴承	
Artykuł już nieprodukowany Снятое с производства изделие	Kifutó cikkszám Výběhový výrobek	Articol care nu se va mai produce Proizvod koji se prestaje proizvoditi	Υπο κατάργηση Üretimi durdurulan ürün	停产零件	
Do wyboru На выбор	Választható Voliteľné	Alternativ Po izboru	Κατ' επιλογή İsteğe bağlı	可选	
Wersja wzmocniona Усиленное исполнение	Megerősített kivitel Zesílené provedení	Varianta consolidată Pojačana izvedba	Ενισχυμένος τύπος Güçlendirilmiş tip	重载配置	HD
Część wymienna Сменяемая деталь	Cserealkatrész Výměnná součást	Piesă de schimb recondiționată Zamjenski dio	Εξάρτημα αντικατάστασης Değiştirme parça	更换零件	#

DE	Deutsch	V3
EN	English	V5
FR	Français	V7
ES	Español	V13
PT	Português	V19
IT	Italiano	V25
NL	Nederlands	V31
NO	Norsk	V37
SV	Svenska	V43
FI	Suomi	V49
PL	Polski	V55
RU	Русский	V61
HU	Magyar	V67
CS	Česky	V73
RO	Română	V79
HR	Hrvatski	V85
EL	Ελληνικά	V91
TR	Türkçe	V97
ZH	中文	V103

Allgemeine Informationen



Sämtliche in diesem Katalog aufgeführten Produkte dürfen nur durch ausgebildetes Personal einer Kfz-Fachwerkstatt verbaut werden.

Für Ihre Anforderungen benötigen wir die vollständige Bestellnummer, zum Beispiel:

Kupplungskit	3400 122 201
Kupplungsdruckplatte	3482 083 032
Kupplungsscheibe	1878 004 832
Ausrücker	3151 000 034

Im Zweifelsfall Typenbezeichnung und Baujahr des Fahrzeugs angeben, für das der gewünschte Artikel bestimmt ist.

Alle Rechte vorbehalten. Vervielfältigungen oder die Mitbenutzung dieses Kataloges, auch auszugsweise, für die Erstellung eines Eigenkataloges sind ohne ausdrückliche Zustimmung unzulässig.

Ersatzteilnummern der Fahrzeughersteller dienen nur zu Vergleichszwecken. Eine Verwendung derartiger Angaben in Rechnungen an den Fahrzeugbesitzer ist nicht statthaft.

Die aktuellen allgemeinen Geschäftsbedingungen finden Sie unter www.zf.com/services/dokumente

www.zf.com/services/katalog

WebCat
Online Katalog

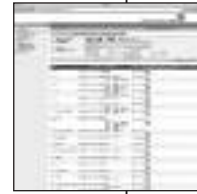

InCat
Elektronischer Katalog



PrintCat
Gedruckte Kataloge



Inhaltsverzeichnis

Index	U2
Symbole	U3 - U4
Allgemeine Informationen	V3
Katalogaufbau	V4
Kenngrößen	V4
Arithmetische Liste	842 - 884
Vergleichsliste	884 - 926
Neuaufnahmen	927 - 928
Geänderte Bestellnummer	929
Gestrichene Nummern	930
Maßtabelle für Nabenprofile	931
Maßtabelle für Schwungscheiben	932 - 933

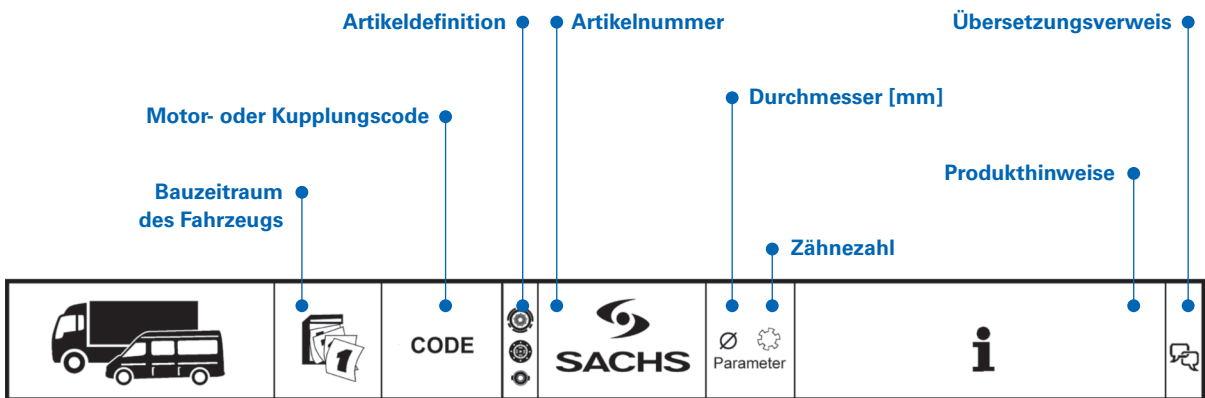

DAF

LF		10.13 -																																																																																									
LF 180		PX-5135	<table border="1"> <tr> <td>3400 700 465</td> <td>362 10</td> <td>Getr. / GBox: 6 S 700</td> <td rowspan="3">(4)</td> </tr> <tr> <td>⊗ 3482 000 859</td> <td>MF362</td> <td>Getr. / GBox: 6 AS 700</td> </tr> <tr> <td>⊗ 1878 005 601</td> <td>362WGTZ</td> <td>Abgasnorm: Euro 6 / Exhaust Emission Norm: Euro 6</td> </tr> <tr> <td>⊙ 3151 000 651</td> <td>KZIS-4</td> <td></td> <td></td> </tr> <tr> <td>3400 700 464</td> <td>362 10</td> <td>Getr. / GBox: 6 S 800</td> <td rowspan="3">(4)</td> </tr> <tr> <td>⊗ 3482 000 859</td> <td>MF362</td> <td>Getr. / GBox: 6 AS 800</td> </tr> <tr> <td>⊗ 1878 005 600</td> <td>362WGTZ</td> <td>Abgasnorm: Euro 6 / Exhaust Emission Norm: Euro 6</td> </tr> <tr> <td>⊙ 3151 000 651</td> <td>KZIS-4</td> <td></td> <td></td> </tr> <tr> <td>3400 700 603</td> <td>350</td> <td>Getr. / GBox: S5-42</td> <td rowspan="3">(4)</td> </tr> <tr> <td>⊗ 3482 001 166</td> <td>MF350</td> <td>Abgasnorm: Euro 6 / Exhaust Emission Norm: Euro 6</td> </tr> <tr> <td>⊗ 1878 007 172</td> <td>350WGTZ</td> <td></td> </tr> <tr> <td>⊙ 3151 000 397</td> <td>KZIS-4</td> <td></td> <td></td> </tr> <tr> <td>LF 210</td> <td></td> <td>PX-5157</td> <td> <table border="1"> <tr> <td>3400 700 465</td> <td>362 10</td> <td>Getr. / GBox: 6 S 700</td> <td rowspan="3">(4)</td> </tr> <tr> <td>⊗ 3482 000 859</td> <td>MF362</td> <td>Getr. / GBox: 6 AS 700</td> </tr> <tr> <td>⊗ 1878 005 601</td> <td>362WGTZ</td> <td>Abgasnorm: Euro 6 / Exhaust Emission Norm: Euro 6</td> </tr> <tr> <td>⊙ 3151 000 651</td> <td>KZIS-4</td> <td></td> <td></td> </tr> <tr> <td>3400 700 464</td> <td>362 10</td> <td>Getr. / GBox: 6 S 800</td> <td rowspan="3">(4)</td> </tr> <tr> <td>⊗ 3482 000 859</td> <td>MF362</td> <td>Getr. / GBox: 6 AS 800</td> </tr> <tr> <td>⊗ 1878 005 600</td> <td>362WGTZ</td> <td>Abgasnorm: Euro 6 / Exhaust Emission Norm: Euro 6</td> </tr> <tr> <td>⊙ 3151 000 651</td> <td>KZIS-4</td> <td></td> <td></td> </tr> <tr> <td>3400 700 603</td> <td>350</td> <td>Getr. / GBox: S5-42</td> <td rowspan="3">(4)</td> </tr> <tr> <td>⊗ 3482 001 166</td> <td>MF350</td> <td>Abgasnorm: Euro 6 / Exhaust Emission Norm: Euro 6</td> </tr> <tr> <td>⊗ 1878 007 172</td> <td>350WGTZ</td> <td></td> </tr> <tr> <td>⊙ 3151 000 397</td> <td>KZIS-4</td> <td></td> <td></td> </tr> </table> </td> </tr> </table>	3400 700 465	362 10	Getr. / GBox: 6 S 700	(4)	⊗ 3482 000 859	MF362	Getr. / GBox: 6 AS 700	⊗ 1878 005 601	362WGTZ	Abgasnorm: Euro 6 / Exhaust Emission Norm: Euro 6	⊙ 3151 000 651	KZIS-4			3400 700 464	362 10	Getr. / GBox: 6 S 800	(4)	⊗ 3482 000 859	MF362	Getr. / GBox: 6 AS 800	⊗ 1878 005 600	362WGTZ	Abgasnorm: Euro 6 / Exhaust Emission Norm: Euro 6	⊙ 3151 000 651	KZIS-4			3400 700 603	350	Getr. / GBox: S5-42	(4)	⊗ 3482 001 166	MF350	Abgasnorm: Euro 6 / Exhaust Emission Norm: Euro 6	⊗ 1878 007 172	350WGTZ		⊙ 3151 000 397	KZIS-4			LF 210		PX-5157	<table border="1"> <tr> <td>3400 700 465</td> <td>362 10</td> <td>Getr. / GBox: 6 S 700</td> <td rowspan="3">(4)</td> </tr> <tr> <td>⊗ 3482 000 859</td> <td>MF362</td> <td>Getr. / GBox: 6 AS 700</td> </tr> <tr> <td>⊗ 1878 005 601</td> <td>362WGTZ</td> <td>Abgasnorm: Euro 6 / Exhaust Emission Norm: Euro 6</td> </tr> <tr> <td>⊙ 3151 000 651</td> <td>KZIS-4</td> <td></td> <td></td> </tr> <tr> <td>3400 700 464</td> <td>362 10</td> <td>Getr. / GBox: 6 S 800</td> <td rowspan="3">(4)</td> </tr> <tr> <td>⊗ 3482 000 859</td> <td>MF362</td> <td>Getr. / GBox: 6 AS 800</td> </tr> <tr> <td>⊗ 1878 005 600</td> <td>362WGTZ</td> <td>Abgasnorm: Euro 6 / Exhaust Emission Norm: Euro 6</td> </tr> <tr> <td>⊙ 3151 000 651</td> <td>KZIS-4</td> <td></td> <td></td> </tr> <tr> <td>3400 700 603</td> <td>350</td> <td>Getr. / GBox: S5-42</td> <td rowspan="3">(4)</td> </tr> <tr> <td>⊗ 3482 001 166</td> <td>MF350</td> <td>Abgasnorm: Euro 6 / Exhaust Emission Norm: Euro 6</td> </tr> <tr> <td>⊗ 1878 007 172</td> <td>350WGTZ</td> <td></td> </tr> <tr> <td>⊙ 3151 000 397</td> <td>KZIS-4</td> <td></td> <td></td> </tr> </table>	3400 700 465	362 10	Getr. / GBox: 6 S 700	(4)	⊗ 3482 000 859	MF362	Getr. / GBox: 6 AS 700	⊗ 1878 005 601	362WGTZ	Abgasnorm: Euro 6 / Exhaust Emission Norm: Euro 6	⊙ 3151 000 651	KZIS-4			3400 700 464	362 10	Getr. / GBox: 6 S 800	(4)	⊗ 3482 000 859	MF362	Getr. / GBox: 6 AS 800	⊗ 1878 005 600	362WGTZ	Abgasnorm: Euro 6 / Exhaust Emission Norm: Euro 6	⊙ 3151 000 651	KZIS-4			3400 700 603	350	Getr. / GBox: S5-42	(4)	⊗ 3482 001 166	MF350	Abgasnorm: Euro 6 / Exhaust Emission Norm: Euro 6	⊗ 1878 007 172	350WGTZ		⊙ 3151 000 397	KZIS-4		
3400 700 465	362 10	Getr. / GBox: 6 S 700	(4)																																																																																								
⊗ 3482 000 859	MF362	Getr. / GBox: 6 AS 700																																																																																									
⊗ 1878 005 601	362WGTZ	Abgasnorm: Euro 6 / Exhaust Emission Norm: Euro 6																																																																																									
⊙ 3151 000 651	KZIS-4																																																																																										
3400 700 464	362 10	Getr. / GBox: 6 S 800	(4)																																																																																								
⊗ 3482 000 859	MF362	Getr. / GBox: 6 AS 800																																																																																									
⊗ 1878 005 600	362WGTZ	Abgasnorm: Euro 6 / Exhaust Emission Norm: Euro 6																																																																																									
⊙ 3151 000 651	KZIS-4																																																																																										
3400 700 603	350	Getr. / GBox: S5-42	(4)																																																																																								
⊗ 3482 001 166	MF350	Abgasnorm: Euro 6 / Exhaust Emission Norm: Euro 6																																																																																									
⊗ 1878 007 172	350WGTZ																																																																																										
⊙ 3151 000 397	KZIS-4																																																																																										
LF 210		PX-5157	<table border="1"> <tr> <td>3400 700 465</td> <td>362 10</td> <td>Getr. / GBox: 6 S 700</td> <td rowspan="3">(4)</td> </tr> <tr> <td>⊗ 3482 000 859</td> <td>MF362</td> <td>Getr. / GBox: 6 AS 700</td> </tr> <tr> <td>⊗ 1878 005 601</td> <td>362WGTZ</td> <td>Abgasnorm: Euro 6 / Exhaust Emission Norm: Euro 6</td> </tr> <tr> <td>⊙ 3151 000 651</td> <td>KZIS-4</td> <td></td> <td></td> </tr> <tr> <td>3400 700 464</td> <td>362 10</td> <td>Getr. / GBox: 6 S 800</td> <td rowspan="3">(4)</td> </tr> <tr> <td>⊗ 3482 000 859</td> <td>MF362</td> <td>Getr. / GBox: 6 AS 800</td> </tr> <tr> <td>⊗ 1878 005 600</td> <td>362WGTZ</td> <td>Abgasnorm: Euro 6 / Exhaust Emission Norm: Euro 6</td> </tr> <tr> <td>⊙ 3151 000 651</td> <td>KZIS-4</td> <td></td> <td></td> </tr> <tr> <td>3400 700 603</td> <td>350</td> <td>Getr. / GBox: S5-42</td> <td rowspan="3">(4)</td> </tr> <tr> <td>⊗ 3482 001 166</td> <td>MF350</td> <td>Abgasnorm: Euro 6 / Exhaust Emission Norm: Euro 6</td> </tr> <tr> <td>⊗ 1878 007 172</td> <td>350WGTZ</td> <td></td> </tr> <tr> <td>⊙ 3151 000 397</td> <td>KZIS-4</td> <td></td> <td></td> </tr> </table>	3400 700 465	362 10	Getr. / GBox: 6 S 700	(4)	⊗ 3482 000 859	MF362	Getr. / GBox: 6 AS 700	⊗ 1878 005 601	362WGTZ	Abgasnorm: Euro 6 / Exhaust Emission Norm: Euro 6	⊙ 3151 000 651	KZIS-4			3400 700 464	362 10	Getr. / GBox: 6 S 800	(4)	⊗ 3482 000 859	MF362	Getr. / GBox: 6 AS 800	⊗ 1878 005 600	362WGTZ	Abgasnorm: Euro 6 / Exhaust Emission Norm: Euro 6	⊙ 3151 000 651	KZIS-4			3400 700 603	350	Getr. / GBox: S5-42	(4)	⊗ 3482 001 166	MF350	Abgasnorm: Euro 6 / Exhaust Emission Norm: Euro 6	⊗ 1878 007 172	350WGTZ		⊙ 3151 000 397	KZIS-4																																																
3400 700 465	362 10	Getr. / GBox: 6 S 700	(4)																																																																																								
⊗ 3482 000 859	MF362	Getr. / GBox: 6 AS 700																																																																																									
⊗ 1878 005 601	362WGTZ	Abgasnorm: Euro 6 / Exhaust Emission Norm: Euro 6																																																																																									
⊙ 3151 000 651	KZIS-4																																																																																										
3400 700 464	362 10	Getr. / GBox: 6 S 800	(4)																																																																																								
⊗ 3482 000 859	MF362	Getr. / GBox: 6 AS 800																																																																																									
⊗ 1878 005 600	362WGTZ	Abgasnorm: Euro 6 / Exhaust Emission Norm: Euro 6																																																																																									
⊙ 3151 000 651	KZIS-4																																																																																										
3400 700 603	350	Getr. / GBox: S5-42	(4)																																																																																								
⊗ 3482 001 166	MF350	Abgasnorm: Euro 6 / Exhaust Emission Norm: Euro 6																																																																																									
⊗ 1878 007 172	350WGTZ																																																																																										
⊙ 3151 000 397	KZIS-4																																																																																										

Kenngrößen

⊗ Kupplungsdruckplatten	
Z/	Für Zweiseibenausführung
400	Reibflächenaußendurchmesser 400 mm
Do	Doppelkupplung, abhängige Ausrückung
Du	Doppelkupplung, unabhängige Ausrückung
/E	XTend
F	Flaches Schwungrad
G	Kupplung mit Gußgehäuse
K	Schraubenfederkupplung
KM	Mit Membranfeder und Hebelsystem
M	Membranfederkupplung
N	Nebenantrieb
S	Schwenkbolzenausführung
T	Mit Tellerfeder
XTend	Mit automatischer Nachstellung
Z	Ausrückung auf Zug

⊗ Kupplungsscheiben	
200	Außendurchmesser 200 mm
CE	Anorganischer Sinterbelag
B/D/E/Z	Belagfederungen
BH/GS/GT/GV	Torsionsdämpfer für Nfz
/E	XTend
W/V	Vordämpfer für Nfz

⊗ Ausrücklager	
...A	Außenring mitlaufend
G	Grafitanlaufing
GK	Grafitanlaufing und Kugellager
GR	Kugellager mit Blechkappe
GZ	Geberzylinder
HHIS	Konzentrischer Nehmerzylinder
...I	Innenring mitlaufend
KT	Teflonanlaufscheibe
KZ	Kugellager, zentralgeführt
NZ	Nehmerzylinder
...S	Selbstzentrierender Innenring
...Z	Ausrückung auf Zug

General Information



The products listed in this catalog must be installed in a workshop by qualified personnel only.

To fulfill your request, we need the complete order number, for example:

Clutch kit	3400 122 201
Clutch pressure plate	3482 083 032
Clutch disk	1878 004 832
Releaser	3151 000 034

In case of doubt, please provide the type description and the model year of the vehicle for which the desired item is intended.

All rights reserved. Duplication or joint use of this catalog, even in extracts, for the creation of your own catalog is prohibited, unless explicit consent is given.

Replacement part numbers from the vehicle manufacturer serve only for purposes of comparison. Use of such information in invoices to the vehicle owner is not permitted.

Current terms and conditions are available at www.zf.com/services/documents

www.zf.com/services/catalog

WebCat

Online catalog

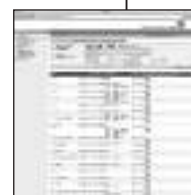

InCat

Electronic catalog



PrintCat

Printed catalogs



Contents

Index	U2
Symbols	U3 - U4
General Information	V5
Catalog structure	V6
Parameters	V6
Part number list	842 - 884
Cross reference list	884 - 926
New to range	927 - 928
Amended part number	929
Deleted numbers	930
Measure table for hub profiles	931
Measure table for flywheels	932 - 933

Catalog structure

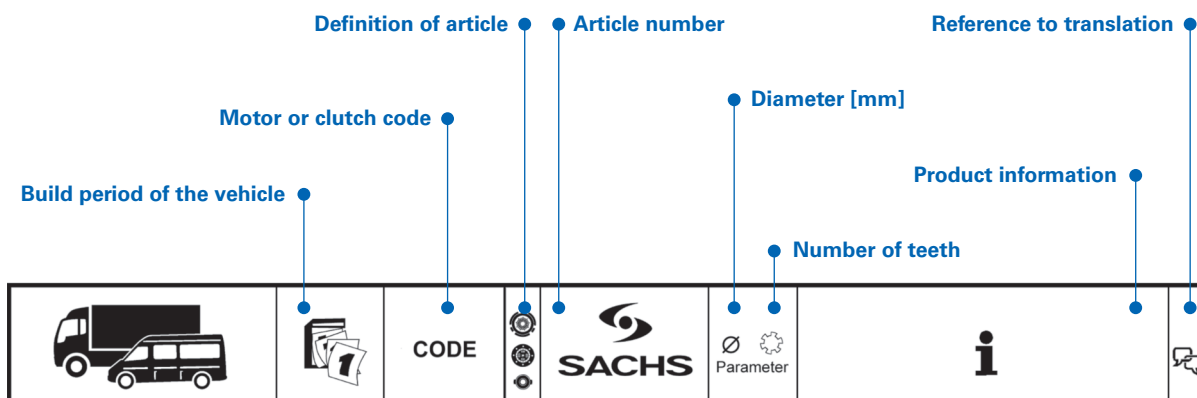

DAF

LF		10.13 -			
LF 180		PX-5135	3400 700 465 3482 000 859 1878 005 601 3151 000 651	362 10 MF362 362WGTZ KZIS-4	Getr. / GBox: 6 S 700 Getr. / GBox: 6 AS 700 Abgasnorm: Euro 6 / Exhaust Emission Norm: Euro 6 (4)
			3400 700 464 3482 000 859 1878 005 600 3151 000 651	362 10 MF362 362WGTZ KZIS-4	Getr. / GBox: 6 S 800 Getr. / GBox: 6 AS 800 Abgasnorm: Euro 6 / Exhaust Emission Norm: Euro 6 (4)
			3400 700 603 3482 001 166 1878 007 172 3151 000 397	350 MF350 350WGTZ KZIS-4	Getr. / GBox: S5-42 Abgasnorm: Euro 6 / Exhaust Emission Norm: Euro 6 (4)
LF 210		PX-5157	3400 700 465 3482 000 859 1878 005 601 3151 000 651	362 10 MF362 362WGTZ KZIS-4	Getr. / GBox: 6 S 700 Getr. / GBox: 6 AS 700 Abgasnorm: Euro 6 / Exhaust Emission Norm: Euro 6 (4)
			3400 700 464 3482 000 859 1878 005 600 3151 000 651	362 10 MF362 362WGTZ KZIS-4	Getr. / GBox: 6 S 800 Getr. / GBox: 6 AS 800 Abgasnorm: Euro 6 / Exhaust Emission Norm: Euro 6 (4)
			3400 700 603 3482 001 166 1878 007 172 3151 000 397	350 MF350 350WGTZ KZIS-4	Getr. / GBox: S5-42 Abgasnorm: Euro 6 / Exhaust Emission Norm: Euro 6 (4)

Parameters

Clutch pressure plates

Z/	For twin disk design
400	Outer friction surface diameter = 400 mm
Do	Double clutch, dependent disengagement
Du	Double clutch, independent disengagement
/E	XTend
F	Flat flywheel
G	Clutch with cast iron housing
K	Coil spring clutch
KM	With diaphragm spring and lever system
M	Diaphragm spring clutch
N	Power take-off
S	Eye bolt design
T	With plate spring
XTend	With automatic adjustment
Z	Pull-type release

Clutch disks

200	Outer diameter 200 mm
CE	Non-organic sinter lining
B/D/E/Z	Cushion
BH/GS/GT/GV	Torsion dampers for CV
/E	XTend
W/V	Preliminary dampers for CV

Predamper

...A	Running outer ring
G	Graphite thrust ring
GK	Graphite thrust ring and ball bearing
GR	Ball bearing with metal cap
GZ	Master cylinder
HHIS	Concentric slave cylinder
...I	Running inner ring
KT	Teflon thrust washer
KZ	Ball bearing, central feed
NZ	Slave cylinder
...S	Self-centering inner ring
...Z	Pull-type release

Informations générales



Tous les produits mentionnés dans ce catalogue doivent exclusivement être montés par le personnel formé d'un atelier automobile qualifié.

Pour répondre à vos exigences, nous avons besoin de connaître le numéro de commande complet, par exemple :

Kit d'embrayage	3400 122 201
Mécanisme d'embrayage	3482 083 032
Disque d'embrayage	1878 004 832
Butée	3151 000 034

En cas de doute, indiquez la désignation du modèle et l'année de construction du véhicule pour lequel la pièce souhaitée est destinée.

Tous droits réservés. La reproduction ou l'utilisation, même partielle, de ce catalogue pour l'élaboration de son propre catalogue est interdite sans notre autorisation expresse.

Les numéros de pièces détachées des constructeurs de véhicules sont uniquement indiqués aux fins de comparaison. Le report de ces données sur les factures destinées au propriétaire du véhicule est illicite.

Vous trouverez les conditions générales sur Internet www.zf.com/services/documents

www.zf.com/services/catalog

WebCat

Catalogue en ligne

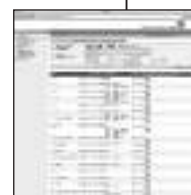

InCat

Catalogue électronique



PrintCat

Catalogues papier



Sommaire

Index	U2
Symboles	U3 - U4
Informations générales	V7
Structure du catalogue	V8
Caractéristiques	V8
Traductions	V9 - V11
Liste des pièces	842 - 884
Liste comparative	884 - 926
Nouveautés	927 - 928
Références modifiées	929
Numéros barrés	930
Table métrologique pour cannelures de moyeu	931
Table métrologique pour volants moteurs	932 - 933

Structure du catalogue

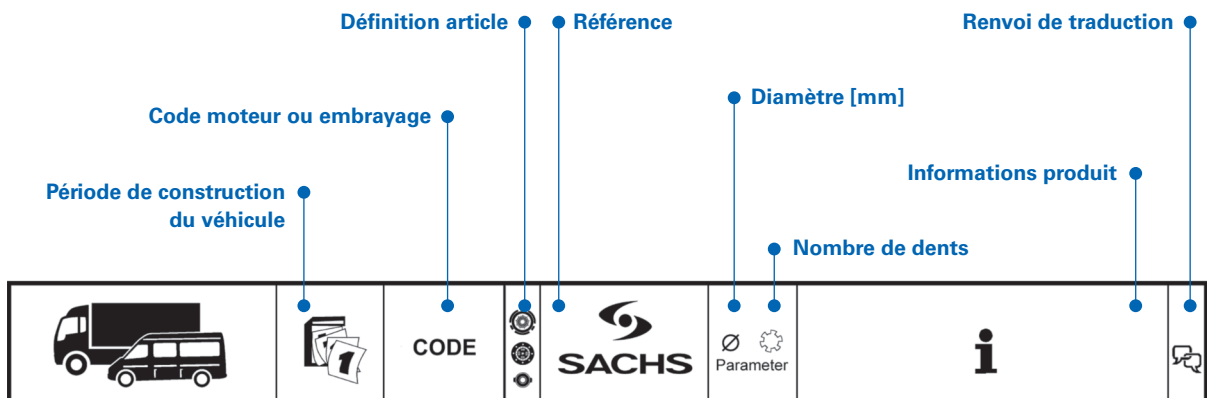

DAF

LF		10.13 -				
LF 180		PX-5135	<ul style="list-style-type: none"> 3400 700 465 <ul style="list-style-type: none"> 3482 000 859 1878 005 601 3151 000 651 3400 700 464 <ul style="list-style-type: none"> 3482 000 859 1878 005 600 3151 000 651 3400 700 603 <ul style="list-style-type: none"> 3482 001 166 1878 007 172 3151 000 397 	<ul style="list-style-type: none"> 362 10 MF362 362WGTZ KZIS-4 362 10 MF362 362WGTZ KZIS-4 350 MF350 350WGTZ KZIS-4 	<ul style="list-style-type: none"> Getr. / GBox: 6 S 700 Getr. / GBox: 6 AS 700 Abgasnorm: Euro 6 / Exhaust Emission Norm: Euro 6 Getr. / GBox: 6 S 800 Getr. / GBox: 6 AS 800 Abgasnorm: Euro 6 / Exhaust Emission Norm: Euro 6 Getr. / GBox: S5-42 Abgasnorm: Euro 6 / Exhaust Emission Norm: Euro 6 	<ul style="list-style-type: none"> (4) (4) (4)
LF 210		PX-5157	<ul style="list-style-type: none"> 3400 700 465 <ul style="list-style-type: none"> 3482 000 859 1878 005 601 3151 000 651 3400 700 464 <ul style="list-style-type: none"> 3482 000 859 1878 005 600 3151 000 651 3400 700 603 <ul style="list-style-type: none"> 3482 001 166 1878 007 172 3151 000 397 	<ul style="list-style-type: none"> 362 10 MF362 362WGTZ KZIS-4 362 10 MF362 362WGTZ KZIS-4 350 MF350 350WGTZ KZIS-4 	<ul style="list-style-type: none"> Getr. / GBox: 6 S 700 Getr. / GBox: 6 AS 700 Abgasnorm: Euro 6 / Exhaust Emission Norm: Euro 6 Getr. / GBox: 6 S 800 Getr. / GBox: 6 AS 800 Abgasnorm: Euro 6 / Exhaust Emission Norm: Euro 6 Getr. / GBox: S5-42 Abgasnorm: Euro 6 / Exhaust Emission Norm: Euro 6 	<ul style="list-style-type: none"> (4) (4) (4)

Caractéristiques

⚙ Mécanismes d'embrayage

Z/	Pour version bidisque
400	Diamètre extérieur surface de frottement 400 mm
Do	Embrayage double, débrayage dépendant
Du	Embrayage double, débrayage indépendant
/E	XTend
F	Volant moteur plat
G	Avec carter en fonte
K	Embrayage à levier
KM	Avec ressort diaphragme et système levier
M	Embrayage à diaphragme
N	Prise de force
S	Modèle axe de pivotement
T	Avec rondelles-ressorts
XTend	Avec ajustement automatique
Z	Embrayage version tiré

⚙ Disques d'embrayage

200	Diamètre extérieur 200 mm
CE	Garniture frittée non-organique
B/D/E/Z	Lamelles de progressivité
BH/GS/GT/GV	Amortisseur de torsion pour VU
/E	XTend
W/V	Pré-amortisseur pour VU

⚙ Butée de débrayage

...A	Bague extérieure entraînée
G	Bague de friction en graphite
GK	Bague de friction en graphite et roulement à billes
GR	Roulement à billes avec cache en tôle
GZ	Cylindre émetteur
HHIS	Cylindre récepteur concentrique
...I	Bague intérieure entraînée
KT	Rondelle de friction en téflon
KZ	Roulement à billes, guidage central
NZ	Cylindre récepteur
...S	Bague intérieure à centrage automatique
...Z	Embrayage version tiré

Traductions

(1)	Norme antipollution : Euro 3
(2)	Norme antipollution : Euro 4 (D4)
(3)	Norme antipollution : Euro 5
(4)	Norme antipollution : Euro 6
(5)	Norme antipollution : Euro 3 / Euro 4
(6)	Norme antipollution : Euro 4 / Euro 5
(7)	Norme antipollution : Euro 5 / Euro 6
(8)	Nombre de garnitures
(9)	Fourche de débrayage suspendue [mm]
(10)	Fourche de débrayage debout [mm]
(11)	Diamètre extérieur [mm]
(12)	Élément de rechange remplacé par 3400 121 002
(13)	En cas de problèmes de bruit
(14)	Contient butée et kit de montage
(15)	Contient volant bimasse ZMS, plateau de pression, disque d'embrayage et débrayeur
(16)	Contient volant bimasse ZMS, plateau de pression, disque d'embrayage et butée hydraulique (CSC)
(17)	Essence
(18)	Largeur [mm]
(19)	Diesel
(20)	Le véhicule peut être monté avec différentes tailles d'embrayages
(21)	Les véhicules peuvent être équipés de différents composants
(22)	Transmission Fuller
(23)	Fluide : Liquide de frein
(24)	Fluide: Huile minérale
(25)	Pour export
(26)	Numéro de transmission
(27)	Longueur de manchon [mm]
(28)	Renouveler systématiquement
(29)	Compris dans 1888
(30)	Compris dans 3483/3488
(31)	Compris dans 3488
(32)	Diamètre intérieur [mm]
(33)	Avec embrayage différent selon le choix du client
(34)	Longueur de câble [mm]
(35)	Caractéristique
(36)	Roulement à billes
(37)	Disque d'embrayage avec pré-amortisseur
(38)	Puissance [kW]
(39)	Disque d'embrayage amovible
(40)	Version nationale : Grande-Bretagne
(41)	Version nationale : Turquie
(42)	Longueur [mm]
(43)	Type de montage : Non pré-assemblé
(44)	Kit de montage pour butée d'embrayage
(45)	Type de moteur
(46)	Cannelure de moyeu
(47)	Roulement à aiguilles
(48)	ID de prise de force

Traductions

(49) Disponible uniquement en cas de retour de pièce usagée (réparation; usine Bielefeld)

(50) Ne monter que si le véhicule est équipé d'un embrayage M

(51) À monter ensemble uniquement

(52) Numéro de production

(53) Empattement [mm]

(54) Boîte de vitesses séquentielle

(55) Boîte de vitesses robotisée

(56) Modèle spécial

(57) Disque d'embrayage rigide

(58) Disque d'embrayage avec ressorts de torsion

(59) Transmission ZF

(60) À partir du numéro de production

(61) Kit de réparation alternatif

(63) Jusqu'au numéro de production

(64) Comprend des vis de fixation pour plateau de pression

(65) Comprend des vis de fixation pour le volant moteur

(66) Comprend un disque d'embrayage

(67) Comprend deux disques d'embrayage

(68) Pour

(69) Pour fourche d'embrayage avec cames

(70) Pour fourche d'embrayage avec rouleaux

(71) Pour véhicules avec embrayage monodisque

(72) Pour véhicules avec multiplicateur d'effort d'embrayage

(73) Pour véhicules avec prise de force

(74) Pour véhicules avec système de freinage à basse pression

(75) Pour véhicules avec ralentisseur

(76) Pour véhicules avec embrayage de pontage de convertisseur

(77) Pour véhicules avec embrayage bi-disques

(78) Pour diamètre intérieur de ressort à diaphragme 100 mm

(79) Pour diamètre intérieur de ressort à diaphragme 120 mm

(80) Pour moteurs avec volant bimasse

(81) Pour moteurs sans volant bimasse

(82) Pour prise de force

(83) Pour numéro OE

(84) Pour profondeur volant [mm]

(85) Selon le modèle avec embrayage différent

(86) Étrier long

(87) Couple moteur max. transmissible [Nm]

(88) Avec bague de friction

(89) Avec lubrification permanente

(90) Avec ralentisseur VR 115E

(91) Avec raccord pour tuyau de graissage

(92) Avec capteur

(93) Avec roue dentée

(94) Avec accessoires

(95) Avec bague intermédiaire

(96) Pas pour

(97) Pas pour numéro de châssis

(98) Pas pour numéro de moteur

Traductions

(99) Pas en combinaison avec disque d'embrayage de remplacement

(100) Uniquement comme remplacement des n° OE indiqués

(101) Uniquement en combinaison avec

(102) Sans bague de friction

(103) Sans raccord pour tuyau de graissage

(104) Sans capteur

(105) Sans bague intermédiaire

DE

EN

FR

ES

PT

IT

NL

NO

SV

FI

PL

RU

HU

CS

RO

HR

EL

TR

ZH

DE

EN

FR

ES

PT

IT

NL

NO

SV

FI

PL

RU

HU

CS

RO

HR

EL

TR

ZH

Memo

Información general



Los productos indicados en este catálogo sólo los puede montar el personal cualificado de un taller mecánico.

Para poder tramitar su solicitud necesitamos el número de pedido completo, por ejemplo:

Kit de embrague	3400 122 201
Plato de presión del embrague	3482 083 032
Disco de embrague	1878 004 832
Dispositivo de desembrague	3151 000 034

En caso de duda, se deberá indicar la designación del tipo y el año de construcción del vehículo, para el que se requiere el artículo deseado.

Quedan reservados todos los derechos.

Queda prohibida la reproducción o el uso de este catálogo (también de forma parcial) para la elaboración de un catálogo propio sin consentimiento expreso.

Los números de las piezas de recambio del fabricante solo se usan para compararlos. No está permitido el empleo de este tipo de datos en las facturas emitidas al propietario del vehículo.

Puede encontrar las condiciones generales de contratación en www.zf.com/services/documents

www.zf.com/services/catalog

WebCat

Catálogo online

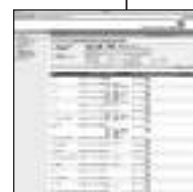

InCat

Catálogo electrónico



PrintCat







Catálogos impresos









Índice

Index	U2
Símbolos	U3 - U4
Información general	V13
Estructura del catálogo	V14
Parámetros	V14
Traducciones	V15 - V17
Lista aritmética	842 - 884
Lista comparativa	884 - 926
Novedades	927 - 928
Número de pedido modificado	929
Referencias eliminadas	930
Tabla de medidas para perfiles del cubo	931
Tabla de medidas para volantes motor	932 - 933

Estructura del catálogo

		CODE				
Período de fabricación del vehículo	Código de motor o embrague		Definición de artículo	Número de artículo	Diámetro [mm]	Indicaciones del producto
				Número de dientes		

DAF

LF	10.13 -					
LF 180		PX-5135	 3400 700 465 ⊗ 3482 000 859 ⊗ 1878 005 601 ⊙ 3151 000 651	362 10 MF362 362WGTZ KZIS-4	Getr. / GBox: 6 S 700 Getr. / GBox: 6 AS 700 Abgasnorm: Euro 6 / Exhaust Emission Norm: Euro 6	(4)
			 3400 700 464 ⊗ 3482 000 859 ⊗ 1878 005 600 ⊙ 3151 000 651	362 10 MF362 362WGTZ KZIS-4	Getr. / GBox: 6 S 800 Getr. / GBox: 6 AS 800 Abgasnorm: Euro 6 / Exhaust Emission Norm: Euro 6	(4)
			 3400 700 603 ⊗ 3482 001 166 ⊗ 1878 007 172 ⊙ 3151 000 397	350 MF350 350WGTZ KZIS-4	Getr. / GBox: S5-42 Abgasnorm: Euro 6 / Exhaust Emission Norm: Euro 6	(4)
LF 210		PX-5157	 3400 700 465 ⊗ 3482 000 859 ⊗ 1878 005 601 ⊙ 3151 000 651	362 10 MF362 362WGTZ KZIS-4	Getr. / GBox: 6 S 700 Getr. / GBox: 6 AS 700 Abgasnorm: Euro 6 / Exhaust Emission Norm: Euro 6	(4)
			 3400 700 464 ⊗ 3482 000 859 ⊗ 1878 005 600 ⊙ 3151 000 651	362 10 MF362 362WGTZ KZIS-4	Getr. / GBox: 6 S 800 Getr. / GBox: 6 AS 800 Abgasnorm: Euro 6 / Exhaust Emission Norm: Euro 6	(4)
			 3400 700 603 ⊗ 3482 001 166 ⊗ 1878 007 172 ⊙ 3151 000 397	350 MF350 350WGTZ KZIS-4	Getr. / GBox: S5-42 Abgasnorm: Euro 6 / Exhaust Emission Norm: Euro 6	(4)

Parámetros

⊗ Platos de presión del embrague	
Z/	Para modelo con disco doble
400	Diámetro exterior de las superficies de fricción 400 mm
Do	Doble embrague, desembrague dependiente
Du	Doble embrague, desembrague independiente
/E	XTend
F	Volante motor plano
G	Embrague con cárter de fundición
K	Embrague de muelle helicoidal
KM	Con muelle de membrana y sistema de palanca
M	Embrague de muelle de membrana
N	Mando auxiliar
S	Modelo de pasador pivote
T	Con muelle Belleville
XTend	Con ajuste automático
Z	Desembrague de tracción

⊗ Discos de embrague	
200	Diámetro exterior 200 mm
CE	Revestimiento sinterizado inorgánico
B/D/E/Z	Apoyos flexibles del revestimiento
BH/GS/GT/GV	Amortiguador de torsión para vehículos industriales
/E	XTend
W/V	Pre-amortiguador para vehículos industriales

⊗ Cojinete de desembrague	
...A	Anillo exterior seguidor
G	Anillo de empuje de grafito
GK	Anillo de empuje de grafito y rodamiento de bolas
GR	Rodamiento de bolas con tapa de chapa
GZ	Cilindro principal
HHIS	Cilindro receptor concéntrico
...I	Anillo interior seguidor
KT	Arandela de tope de teflón
KZ	Rodamiento de bolas, centrado
NZ	Cilindro receptor
...S	Anillo interior autocentrante
...Z	Desembrague de tracción

Traducciones

(1)	Norma de emisión: Euro 3
(2)	Norma de emisión: Euro 4 (D4)
(3)	Norma de emisión: Euro 5
(4)	Norma de emisión: Euro 6
(5)	Norma de emisión: Euro 3 / Euro 4
(6)	Norma de emisión: Euro 4 / Euro 5
(7)	Norma de emisión: Euro 5 / Euro 6
(8)	Número de forros
(9)	Horquilla de desembrague suspendida [mm]
(10)	Horquilla de desembrague vertical [mm]
(11)	Diámetro exterior [mm]
(12)	Pieza reacondicionada sustituida por 3400 121 002
(13)	En caso de problemas de ruidos
(14)	Contiene dispositivo de desembrague y kit de montaje
(15)	Contiene volante bimasa (ZMS), plato de presión, disco de embrague y dispositivo de desembrague
(16)	Contiene volante bimasa (ZMS), plato de presión, disco de embrague y CSC
(17)	Gasolina
(18)	Ancho [mm]
(19)	Gasóleo
(20)	El vehículo se puede montar con diversos tamaños de embrague
(21)	Los vehículos se pueden equipar con distintos componentes
(22)	Caja de cambios Fuller
(23)	Medio de llenado: Líquido de frenos
(24)	Medio de llenado: Aceite mineral
(25)	Para exportación
(26)	Número de caja de cambios
(27)	Longitud del manguito [mm]
(28)	Sustituir siempre
(29)	Incluido en 1888
(30)	Incluido en 3483/3488
(31)	Incluido en 3488
(32)	Diámetro interior [mm]
(33)	Equipado con diferente embrague (según petición del cliente)
(34)	Longitud de cable [mm]
(35)	Parámetro
(36)	Rodamiento de bolas
(37)	Disco de embrague con amortiguador previo
(38)	Potencia [kW]
(39)	Disco de embrague suelto
(40)	Modelo nacional: Gran Bretaña
(41)	Modelo nacional: Turquía
(42)	Longitud [mm]
(43)	Tipo de montaje: No premontado
(44)	Juego de montaje para cojinete de desembrague
(45)	Versión de motor
(46)	Perfil del buje
(47)	Cojinete de agujas
(48)	ID de mando auxiliar

Traducciones

(49) Sólo disponible para devolución de piezas usadas (reparación, fábrica en Bielefeld)

(50) Montar solamente si el vehículo está equipado con embrague de tipo M

(51) Montar solamente en conjunto

(52) Número de producción

(53) Distancia entre ejes [mm]

(54) Caja de cambios manual, secuencial

(55) Caja de cambios manual, automatizada

(56) Modelo especial

(57) Disco rígido de embrague

(58) Disco de embrague con amortiguador de torsión

(59) Caja de cambios ZF

(60) Desde número de producción

(61) Kit de reparación opcional

(63) Hasta número de producción

(64) Incluye tornillos de fijación del plato de presión

(65) Incluye tornillos de fijación de motor volante

(66) Incluye un disco de embrague

(67) Incluye dos discos de embrague

(68) Para

(69) Para horquilla de desembrague con levas

(70) Para horquilla de desembrague con rodillos

(71) Para vehículos con embrague monodisco

(72) Para vehículos con servoembrague

(73) Para vehículos con mando auxiliar

(74) Para vehículos con sistema de frenado de baja presión

(75) Para vehículos con retardador

(76) Para vehículos con convertidor de par

(77) Para vehículos con embrague de disco doble

(78) Para un diámetro interior del muelle de diafragma de 100 mm

(79) Para un diámetro interior del muelle de diafragma de 120 mm

(80) Para motores con volante bimasa

(81) Para motores sin volante bimasa

(82) Para mando auxiliar

(83) Para número OE

(84) Para profundidad de volante [mm]

(85) Con diferente embrague según versión

(86) Brida de fijación larga

(87) Par del motor máximo transmisible [Nm]

(88) Con anillo de empuje

(89) Con lubricación permanente

(90) Con retardador VR 115E

(91) Con conexión para tubo de engrase

(92) Con sensor

(93) Con corona dentada

(94) Con accesorios

(95) Con anillo intermedio

(96) No para

(97) No para número de chasis

(98) No para número de motor

Traducciones

(99) No en conexión con el disco de embrague de recambio

(100) Solo como recambio para los n.º OE indicados

(101) Solo en conexión con

(102) Sin anillo de empuje

(103) Sin conexión para tubo de engrase

(104) Sin sensor

(105) Sin anillo intermedio

DE

EN

FR

ES

PT

IT

NL

NO

SV

FI

PL

RU

HU

CS

RO

HR

EL

TR

ZH

DE

EN

FR

ES

PT

IT

NL

NO

SV

FI

PL

RU

HU

CS

RO

HR

EL

TR

ZH

Memo

Informações gerais



Todos os produtos listados neste catálogo podem ser montados apenas por pessoal qualificado de uma oficina especializada.

Para responder aos seus requisitos, precisamos do número de referência completo, por exemplo:

Kit de embreagem	3400 122 201
Placa de pressão da embreagem	3482 083 032
Disco de embreagem	1878 004 832
Dispositivo de desengate	3151 000 034

Em caso de dúvidas, indicar a designação do tipo e o ano de fabricação do veículo para o qual o artigo pretendido se destina.

Todos os direitos reservados.

Não é permitida a reprodução ou o compartilhamento deste catálogo, mesmo que em parte, para a criação de um catálogo próprio sem a autorização expressa.

Os números das peças sobresselentes do fabricante de veículos destinam-se apenas a fins comparativos. Não é permitida uma utilização de indicações deste tipo nas faturas enviadas ao proprietário do veículo.

As condições gerais de venda atualmente em vigor podem ser consultadas em www.zf.com/services/documents

www.zf.com/services/catalog

WebCat
Catálogo online

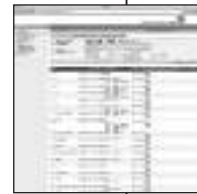

InCat
Catálogo eletrônico



PrintCat
Catálogos impresso



Índice

Index	U2
Símbolos	U3 - U4
Informações gerais	V19
Estrutura do catálogo	V20
Parâmetros	V20
Transmissões	V21 - V23
Lista aritmética	842 - 884
Lista comparativa	884 - 926
Novas adições	927 - 928
Número de pedido alterado	929
Números eliminados	930
Tabela de dimensões para perfis do cubo	931
Tabela de dimensões para volantes	932 - 933

Estrutura do catálogo

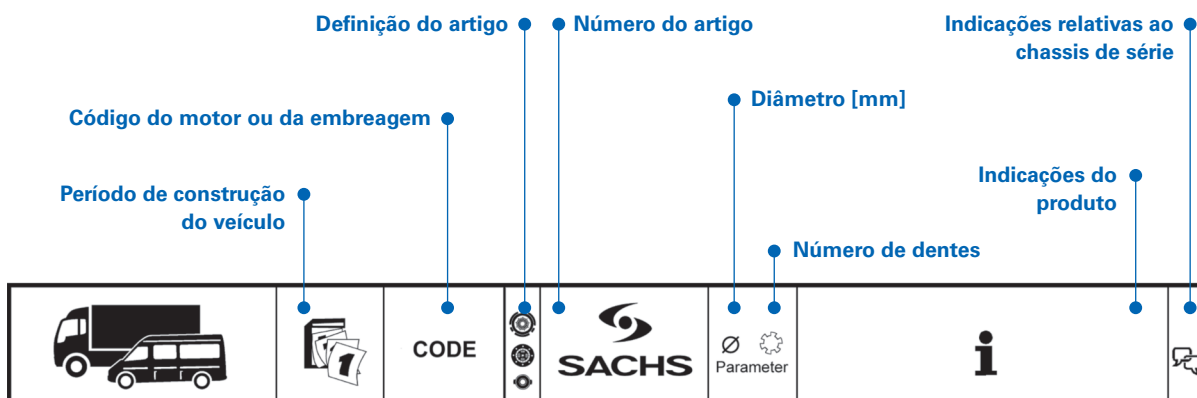

DAF

LF		10.13 -			
LF 180	PX-5135	3400 700 465 3482 000 859 1878 005 601 3151 000 651	362 10 MF362 362WGTZ KZIS-4	Getr. / GBox: 6 S 700 Getr. / GBox: 6 AS 700 Abgasnorm: Euro 6 / Exhaust Emission Norm: Euro 6	(4)
		3400 700 464 3482 000 859 1878 005 600 3151 000 651	362 10 MF362 362WGTZ KZIS-4	Getr. / GBox: 6 S 800 Getr. / GBox: 6 AS 800 Abgasnorm: Euro 6 / Exhaust Emission Norm: Euro 6	(4)
		3400 700 603 3482 001 166 1878 007 172 3151 000 397	350 MF350 350WGTZ KZIS-4	Getr. / GBox: S5-42 Abgasnorm: Euro 6 / Exhaust Emission Norm: Euro 6	(4)
LF 210	PX-5157	3400 700 465 3482 000 859 1878 005 601 3151 000 651	362 10 MF362 362WGTZ KZIS-4	Getr. / GBox: 6 S 700 Getr. / GBox: 6 AS 700 Abgasnorm: Euro 6 / Exhaust Emission Norm: Euro 6	(4)
		3400 700 464 3482 000 859 1878 005 600 3151 000 651	362 10 MF362 362WGTZ KZIS-4	Getr. / GBox: 6 S 800 Getr. / GBox: 6 AS 800 Abgasnorm: Euro 6 / Exhaust Emission Norm: Euro 6	(4)
		3400 700 603 3482 001 166 1878 007 172 3151 000 397	350 MF350 350WGTZ KZIS-4	Getr. / GBox: S5-42 Abgasnorm: Euro 6 / Exhaust Emission Norm: Euro 6	(4)

Parâmetros

Placas de pressão da embreagem

Z/	Para versão de dois pratos
400	Diâmetro exterior da superfície de atrito 400 mm
Do	Embreagem dupla, desengate dependente
Du	Embreagem dupla, desengate independente
/E	XTend
F	Volante de inércia plano
G	Embreagem com carcaça fundida
K	Embreagem de mola helicoidal
KM	Com mola de diafragma e sistema de alavancas
M	Embreagem de mola de diafragma
N	Acionamento auxiliar
S	Versão de pino rotativo
T	Com mola tipo prato
XTend	Com ajuste automático
Z	Desengate por tração

Discos de embreagem

200	Diâmetro exterior 200 mm
CE	Revestimento sinterizado inorgânico
B/D/E/Z	Suspensões do revestimento
BH/GS/GT/GV	Amortecedores da rotação para veículos utilitários
/E	XTend
W/V	Pré-amortecedor para veículos utilitários

Rolamento de embreagem

...A	Anel exterior em rotação
G	Anel de encosto de grafite
GK	Anel de encosto de grafite e rolamento de esferas
GR	Rolamento de esferas com capa de chapa
GZ	Cilindro mestre
HHIS	Cilindro escravo concêntrico
...I	Anel interior em rotação
KT	Disco de partida em teflon
KZ	Rolamento de esferas, com controle central
NZ	Cilindro escravo
...S	Anel interior com centralização automática
...Z	Desengate por tração

Transmissões

- (1) Norma dos gases de escape: Euro 3
- (2) Norma dos gases de escape: Euro 4 (D4)
- (3) Norma dos gases de escape: Euro 5
- (4) Norma dos gases de escape: Euro 6
- (5) Norma dos gases de escape: Euro 3 / Euro 4
- (6) Norma dos gases de escape: Euro 4 / Euro 5
- (7) Norma dos gases de escape: Euro 5 / Euro 6
- (8) Número de revestimentos
- (9) Garfo de embreagem suspenso [mm]
- (10) Garfo de embreagem parado [mm]
- (11) Diâmetro externo [mm]
- (12) Peça remanufaturada substituída por 3400 121 002
- (13) Em caso de problemas de ruído
- (14) Contém dispositivo de engate e kit de montagem
- (15) Contém VDM, placa de pressão, disco de embreagem e dispositivo de engate
- (16) Contém VDM, placa de pressão, disco de embreagem e CSC
- (17) Gasolina
- (18) Largura [mm]
- (19) Diesel
- (20) O veículo pode estar equipado com acoplamentos de diferentes tamanhos
- (21) Os veículos podem estar equipados com diferentes componentes
- (22) Caixa de câmbio Fuller
- (23) Produto de enchimento: Líquido de frenagem
- (24) Produto de enchimento: Óleo mineral
- (25) Para exportação
- (26) Número da caixa de câmbio
- (27) Comprimento da manga [mm]
- (28) Substituir sempre
- (29) Incluído em 1888
- (30) Incluído em 3483/3488
- (31) Incluído em 3488
- (32) Diâmetro interior [mm]
- (33) Com embreagem diferente consoante o desejo do cliente
- (34) Comprimento do cabo [mm]
- (35) Parâmetro
- (36) Rolamento de esferas
- (37) Disco de embreagem com amortecedor prévio
- (38) Potência [kW]
- (39) Disco de embreagem solto
- (40) Versão do país: Grã-Bretanha
- (41) Versão do país: Turquia
- (42) Comprimento [mm]
- (43) Tipo de montagem: Sem pré-instalação
- (44) Kit de montagem para rolamento de embreagem
- (45) Tipo de construção do motor
- (46) Perfil do cubo
- (47) Rolamento de agulhas
- (48) Identificação do acionamento secundário
- (49) Apenas disponível na devolução da peça antiga (reparo; fábrica Bielefeld)

Transmissões

(50) Montar apenas se o veículo estiver equipado com embreagem M

(51) Montar apenas em conjunto

(52) Número de produção

(53) Distância entre eixos [mm]

(54) Caixa de câmbio manual sequencial

(55) Caixa de câmbio manual, acionada automaticamente

(56) Versão especial

(57) Disco de embreagem rígido

(58) Disco de embreagem com molas de torção

(59) Caixa de câmbio ZF

(60) A partir do número de produção

(61) Conjunto de reparo alternativo

(63) Até o número de produção

(64) Contém parafusos de fixação da placa de pressão

(65) Contém parafusos de fixação do volante de inércia

(66) Inclui um disco de embreagem

(67) Inclui dois discos de embreagem

(68) Para

(69) Para garfo de embreagem com cames

(70) Para garfo de embreagem com rolos

(71) Para veículos com embreagem monodisco

(72) Para veículos com reforço da pressão da embreagem

(73) Para veículos com acionamento secundário

(74) Para veículos com sistema de frenagem de baixa pressão

(75) Para veículos com retarder

(76) Para veículos com embreagem do conversor de torque

(77) Para veículos com embreagem de disco duplo

(78) Para diâmetros internos da mola de diafragma de 100 mm

(79) Para diâmetros internos da mola de diafragma de 120 mm

(80) Para motores com volante de dupla massa

(81) Para motores sem volante de dupla massa

(82) Para o acionamento auxiliar

(83) Para número OE

(84) Para profundidade do volante de inércia [mm]

(85) Consoante a versão, com embreagem diferente

(86) Alça comprida

(87) Torque do motor máx. transferível [Nm]

(88) Com anel de encosto

(89) Com lubrificação permanente

(90) Com retarder VR 115E

(91) Com conexão ao tubo de lubrificante

(92) Com sensor

(93) Com coroa dentada

(94) Com acessórios

(95) Com anel intermediário

(96) Não para

(97) Não para número do chassis

(98) Não para número do motor

(99) Não em conjunto com disco de embreagem-de substituição

Transmissões

(100) Apenas como substituição para o nº OE indicado

(101) Apenas em conjunto com

(102) Sem anel de encosto

(103) Sem conexão ao tubo de lubrificante

(104) Sem sensor

(105) Sem anel intermediário

DE

EN

FR

ES

PT

IT

NL

NO

SV

FI

PL

RU

HU

CS

RO

HR

EL

TR

ZH

DE

EN

FR

ES

PT

IT

NL

NO

SV

FI

PL

RU

HU

CS

RO

HR

EL

TR

ZH

Memo

Informazioni generali



Tutti i prodotti riportati in questo catalogo possono essere impiegati solo dal personale qualificato di una autofficina.

Per soddisfare le vostre richieste, abbiamo bisogno del numero di ordine completo, ad esempio:

Kit frizione	3400 122 201
Spingidisco della frizione	3482 083 032
Disco frizione	1878 004 832
Cuscinetto reggispinta	3151 000 034

In caso di dubbio fornire il nome del modello e l'anno di costruzione del veicolo per il quale è destinato l'articolo desiderato.

Tutti i diritti riservati. La riproduzione o la condivisione di questo catalogo, anche parziale, per la realizzazione di un proprio catalogo non sono consentite previo consenso espresso.

I numeri dei ricambi del produttore di veicoli servono solo a scopi comparativi. Un utilizzo di tali dati in fatture inviate ai proprietari dei veicoli non è consentito.

Le condizioni commerciali generali aggiornate sono reperibili all'indirizzo www.zf.com/services/documents

www.zf.com/services/catalog

WebCat

Catalogo online

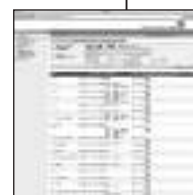

InCat

Catalogo elettronico



PrintCat

Cataloghi stampati



Indice

Index	U2
Simboli	U3 - U4
Informazioni generali	V25
Struttura del catalogo	V26
Grandezze caratteristiche	V26
Traduzioni	V27 - V29
Lista aritmetica	842 - 884
Elenco di confronto	884 - 926
Nuove acquisizioni	927 - 928
Numero d'ordine modificato	929
Numeri eliminati	930
Tabella misure per profili mozzo	931
Tabella misure per dischi del volano	932 - 933

Struttura del catalogo

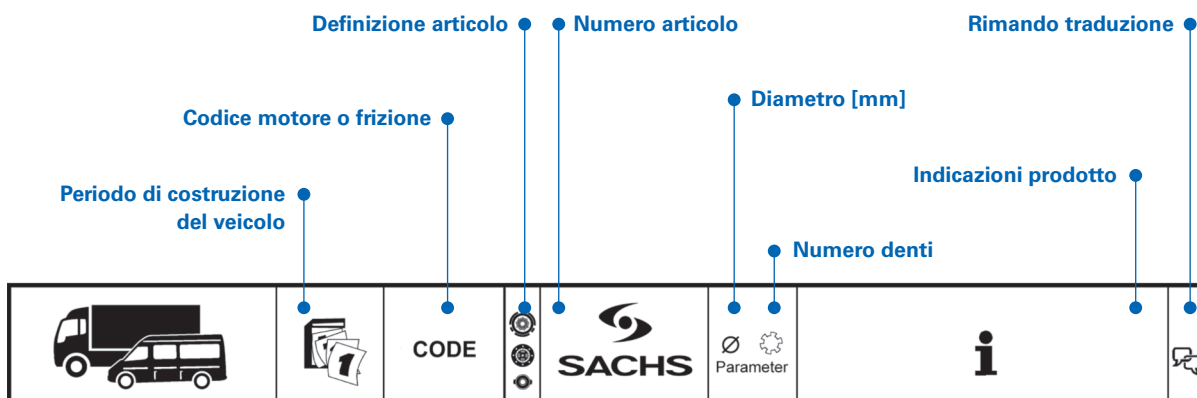

DAF

LF		10.13 -	
LF 180	PX-5135	3400 700 465 3482 000 859 1878 005 601 3151 000 651	362 10 MF362 362WGTZ KZIS-4 Getr. / GBox: 6 S 700 Getr. / GBox: 6 AS 700 Abgasnorm: Euro 6 / Exhaust Emission Norm: Euro 6 (4)
		3400 700 464 3482 000 859 1878 005 600 3151 000 651	362 10 MF362 362WGTZ KZIS-4 Getr. / GBox: 6 S 800 Getr. / GBox: 6 AS 800 Abgasnorm: Euro 6 / Exhaust Emission Norm: Euro 6 (4)
		3400 700 603 3482 001 166 1878 007 172 3151 000 397	350 MF350 350WGTZ KZIS-4 Getr. / GBox: S5-42 Abgasnorm: Euro 6 / Exhaust Emission Norm: Euro 6 (4)
LF 210	PX-5157	3400 700 465 3482 000 859 1878 005 601 3151 000 651	362 10 MF362 362WGTZ KZIS-4 Getr. / GBox: 6 S 700 Getr. / GBox: 6 AS 700 Abgasnorm: Euro 6 / Exhaust Emission Norm: Euro 6 (4)
		3400 700 464 3482 000 859 1878 005 600 3151 000 651	362 10 MF362 362WGTZ KZIS-4 Getr. / GBox: 6 S 800 Getr. / GBox: 6 AS 800 Abgasnorm: Euro 6 / Exhaust Emission Norm: Euro 6 (4)
		3400 700 603 3482 001 166 1878 007 172 3151 000 397	350 MF350 350WGTZ KZIS-4 Getr. / GBox: S5-42 Abgasnorm: Euro 6 / Exhaust Emission Norm: Euro 6 (4)

Grandezze caratteristiche

Spingidisco della frizione

Z/	Solo per modello con due dischi
400	Diametro esterno superficie di attrito 400 mm
Do	Doppia frizione, disinnesto azionato in modo dipendente
Du	Doppia frizione, disinnesto azionato in modo indipendente
/E	XTend
F	Volano piatto
G	Frizione con scatola in ghisa
K	Frizione a molla elicoidale
KM	Con molla a diaframma e sistema di leve
M	Frizione con molla a diaframma
N	Presca di forza
S	Esecuzione perno oscillante
T	Con molla a tazza
XTend	Con regolazione automatica
Z	Disinnesto in trazione

Dischi frizione

200	Diametro esterno 200 mm
CE	Pastiglia sinterizzata in materiale inorganico
B/D/E/Z	Sospensione pastiglia freno
BH/GS/GT/GV	Smorzatore torsionale per veicoli commerciali
/E	XTend
W/V	Preammortizzatore per veicoli commerciali

Cuscinetto di disinnesto

...A	Anello esterno mobile
G	Anello di guida in grafite
GK	Anello di guida in grafite e cuscinetto a sfere
GR	Cuscinetto a sfere con calotta in lamiera
GZ	Pompa idraulica
HHIS	Cilindro ricevitore concentrico
...I	Anello interno mobile
KT	Disco di scorrimento in teflon
KZ	Cuscinetto a sfere, centrante
NZ	Cilindro ricevitore
...S	Anello interno autocentrante
...Z	Disinnesto in trazione

Traduzioni

(1)	Norma sui gas di scarico: Euro 3
(2)	Norma sui gas di scarico: Euro 4 (D4)
(3)	Norma sui gas di scarico: Euro 5
(4)	Norma sui gas di scarico: Euro 6
(5)	Norma sui gas di scarico: Euro 3 / Euro 4
(6)	Norma sui gas di scarico: Euro 4 / Euro 5
(7)	Norma sui gas di scarico: Euro 5 / Euro 6
(8)	Numero delle guarnizioni
(9)	Forcella di disinnesto sospesa [mm]
(10)	Forcella di disinnesto verticale [mm]
(11)	Diametro esterno [mm]
(12)	Componente intercambiabile sostituito da 3400 121 002
(13)	In caso di problemi di rumorosità
(14)	Contiene cuscinetto reggispinta e kit di montaggio
(15)	Contiene volano bimassa, spingidisco, disco e sistema di disinnesto
(16)	Contiene volano bimassa, spingidisco, disco e CSC
(17)	Benzina
(18)	Larghezza [mm]
(19)	Diesel
(20)	Il veicolo può essere equipaggiato con frizioni di diversi diametri
(21)	I veicoli possono essere dotati di diversi componenti
(22)	Cambio Fuller
(23)	Fluido di riempimento: Liquido freni
(24)	Fluido di riempimento: Olio minerale
(25)	Per l'esportazione
(26)	Numero cambio
(27)	Lunghezza guaina [mm]
(28)	Sostituire sempre
(29)	Contenuto in 1888
(30)	Contenuto in 3483/3488
(31)	Contenuto in 3488
(32)	Diametro interno [mm]
(33)	Su richiesta del cliente fornito con frizione diversa
(34)	Lunghezza cavo [mm]
(35)	Grandezza caratteristica
(36)	Cuscinetto a sfere
(37)	Disco frizione con ammortizzatore anteriore
(38)	Potenza [kW]
(39)	Disco frizione sciolto
(40)	Versione paese: Gran Bretagna
(41)	Versione paese: Turchia
(42)	Lunghezza [mm]
(43)	Tipo di montaggio: Non preassemblato
(44)	Kit di montaggio per cuscinetto di disinnesto
(45)	Tipo motore
(46)	Profilo mozzo
(47)	Cuscinetti a rullini
(48)	ID presa di forza
(49)	Consegnabile solo in caso di restituzione del pezzo vecchio (riparazioni; stabilimento di Bielefeld)

Traduzioni

(50) Da montare solo se il veicolo è equipaggiato con una frizione M

(51) Solo da utilizzare congiuntamente

(52) Numero di produzione

(53) Passo [mm]

(54) Cambio sequenziale

(55) Cambio manuale, automatizzato

(56) Versione speciale

(57) Disco frizione rigido

(58) Disco frizione con molla torsionale

(59) Cambio ZF

(60) Da numero produzione

(61) Kit riparazione alternativo

(63) Fino a numero di produzione

(64) Comprende le viti di fissaggio per spingidisco

(65) Comprende le viti di fissaggio per volano

(66) Comprende un dischi frizione

(67) Comprende due dischi frizione

(68) Per

(69) Per forcella di disinnesto con camme

(70) Per forcella di disinnesto con rulli

(71) Per veicoli con frizione monodisco

(72) Per veicoli con servofrizione

(73) Per veicoli con presa di forza

(74) Per veicoli con impianto frenante a bassa pressione

(75) Per veicoli con retarder

(76) Per veicoli con convertitore di coppia-frizione

(77) Per veicoli con frizione bidisco

(78) Per molle della membrana con diametro interno di 100 mm

(79) Per molle della membrana con diametro interno di 120 mm

(80) Per motori con volano a doppia massa

(81) Per motori senza volano a doppia massa

(82) Per presa di forza

(83) Per codice OE

(84) Per profondità volano [mm]

(85) A seconda della versione con frizione diversa

(86) Staffa lunga

(87) Coppia motore max. trasmissibile [Nm]

(88) Con anello di guida

(89) Con lubrificazione permanente

(90) Con retarder VR 115E

(91) Con raccordo lubrificazione

(92) Con sensore

(93) Con corona dentata

(94) Con accessori

(95) Con anello intermedio

(96) Non per

(97) Non per numero telaio

(98) Non per numero motore

(99) Non in abbinamento a disco della frizione di ricambio

Traduzioni

(100) Solo come ricambio per il n° OE indicato

(101) Solo in combinazione con

(102) Senza anello di guida

(103) Senza raccordo lubrificazione

(104) Senza sensore

(105) Senza anello intermedio

DE

EN

FR

ES

PT

IT

NL

NO

SV

FI

PL

RU

HU

CS

RO

HR

EL

TR

ZH

DE

EN

FR

ES

PT

IT

NL

NO

SV

FI

PL

RU

HU

CS

RO

HR

EL

TR

ZH

Memo

Algemene informatie



Alle in deze catalogus vermeldde producten mogen alleen door opgeleid personeel van een autowerkplaats ingebouwd worden.

Voor uw aanvragen hebben wij het volledige bestelnummer nodig, bijvoorbeeld:

Koppelingskit	3400 122 201
Drukgroep	3482 083 032
Koppelingsplaat	1878 004 832
Koppelingsdrukklager	3151 000 034

Bij twijfel dienen de typeaanduiding en het bouwjaar van het voertuig te worden opgegeven, waarvoor het gewenste artikel bestemd is.

Alle rechten voorbehouden. Vermenigvuldigingen of het medegebruik van deze catalogus, ook bij wijze van uittreksel, voor het maken van een eigen catalogus zijn zonder uitdrukkelijke toestemming niet toegestaan.

Onderdeelnummers van het voertuig van de fabrikant zijn alleen bedoeld om te vergelijken. Het gebruik van dergelijke gegevens op facturen voor de eigenaar van het voertuig is niet toegestaan.

De actuele algemene voorwaarden vindt u op www.zf.com/services/documents

www.zf.com/services/catalog

WebCat

Onlinecatalogus

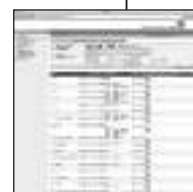

InCat

Elektronische catalogus



PrintCat

Gedrukte catalogi



Inhoudsopgave

Index	U2
Symbolen	U3 - U4
Algemene informatie	V31
Opbouw van de catalogus	V32
Parameters	V32
Vertalingen	V33 - V35
Aritmetische lijst	842 - 884
Vergelijkingslijst	884 - 926
Nieuwe opnames	927 - 928
Gewijzigd bestelnummer	929
Doorgestreepte nummers	930
Maattabel voor naafprofielen	931
Maattabel voor vliegwielen	932 - 933

Opbouw van de catalogus

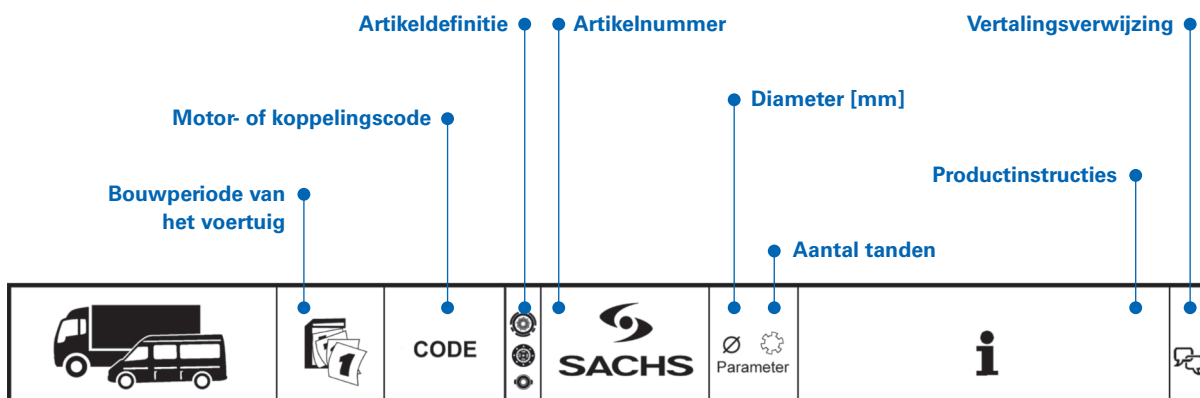

DAF

LF		10.13 -				
LF 180		PX-5135	3400 700 465 3482 000 859 1878 005 601 3151 000 651	362 10 MF362 362WGTZ KZIS-4	Getr. / GBox: 6 S 700 Getr. / GBox: 6 AS 700 Abgasnorm: Euro 6 / Exhaust Emission Norm: Euro 6	(4)
			3400 700 464 3482 000 859 1878 005 600 3151 000 651	362 10 MF362 362WGTZ KZIS-4	Getr. / GBox: 6 S 800 Getr. / GBox: 6 AS 800 Abgasnorm: Euro 6 / Exhaust Emission Norm: Euro 6	(4)
			3400 700 603 3482 001 166 1878 007 172 3151 000 397	350 MF350 350WGTZ KZIS-4	Getr. / GBox: S5-42 Abgasnorm: Euro 6 / Exhaust Emission Norm: Euro 6	(4)
LF 210		PX-5157	3400 700 465 3482 000 859 1878 005 601 3151 000 651	362 10 MF362 362WGTZ KZIS-4	Getr. / GBox: 6 S 700 Getr. / GBox: 6 AS 700 Abgasnorm: Euro 6 / Exhaust Emission Norm: Euro 6	(4)
			3400 700 464 3482 000 859 1878 005 600 3151 000 651	362 10 MF362 362WGTZ KZIS-4	Getr. / GBox: 6 S 800 Getr. / GBox: 6 AS 800 Abgasnorm: Euro 6 / Exhaust Emission Norm: Euro 6	(4)
			3400 700 603 3482 001 166 1878 007 172 3151 000 397	350 MF350 350WGTZ KZIS-4	Getr. / GBox: S5-42 Abgasnorm: Euro 6 / Exhaust Emission Norm: Euro 6	(4)

Parameters

Koppelingsdrukgroepen

Z/	Voor uitvoering met dubbele platen
400	Buitendiameter wrijvingsvlak 400 mm
Do	Dubbele koppeling, afhankelijke ontkoppeling
Du	Dubbele koppeling, onafhankelijke ontkoppeling
/E	XTend
F	Vlak vlieg wiel
G	Koppeling met gegoten behuizing
K	Schroefveerkoppeling
KM	Met membraanveer en hendelsysteem
M	Membraanveerkoppeling
N	Power take-off
S	Draaipenuitvoering
T	Met schotelveer
XTend	Met automatische nastelling
Z	Getrokken ontkoppeling

Koppelingsplaten

200	Buitendiameter 200 mm
CE	Anorganische sinterbekleding
B/D/E/Z	Bekledingsveren
BH/GS/GT/GV	Torsiedempers voor bedrijfswagens
/E	XTend
W/V	Voordempers voor bedrijfswagens

Koppelingsdrukager

...A	Buitenring meelopend
G	Grafietaanloopring
GK	Grafietaanloopring en kogellager
GR	Kogellager met plaatkap
GZ	Commandocilinder
HHIS	Concentrische werkcilinder
...I	Binnenring meelopend
KT	Teflonaanloopring
KZ	Kogellager, centraal geleid
NZ	Werkcilinder
...S	Zelfcentrerende binnenring
...Z	Getrokken ontkoppeling

Vertalingen

(1)	Uitlaatgasnorm: Euro 3
(2)	Uitlaatgasnorm: Euro 4 (D4)
(3)	Uitlaatgasnorm: Euro 5
(4)	Uitlaatgasnorm: Euro 6
(5)	Uitlaatgasnorm: Euro 3 / Euro 4
(6)	Uitlaatgasnorm: Euro 4 / Euro 5
(7)	Uitlaatgasnorm: Euro 5 / Euro 6
(8)	Aantal voeringen
(9)	Ontkoppelingsvork hangend [mm]
(10)	Ontkoppelingsvork staand [mm]
(11)	Buitendiameter [mm]
(12)	Gereviseerd onderdeel vervangen door 3400 121 002
(13)	Bij geluidsproblemen
(14)	Bevat koppelingsdrukklager en montageset
(15)	Bevat dubbel vliegwiel, drukgroep, koppelingsplaat en ontkoppelaar
(16)	Bevat dubbel vliegwiel, drukgroep, koppelingsplaat en CSC
(17)	Benzine
(18)	Breedte [mm]
(19)	Diesel
(20)	Het voertuig kan met verschillende koppelingsgroottes worden uitgerust
(21)	Voertuigen kunnen met verschillende componenten zijn uitgerust
(22)	Fuller-versnellingsbak
(23)	Vulmedium: Remvloeistof
(24)	Vulmedium: Minerale olie
(25)	Voor export
(26)	Versnellingsbaknummer
(27)	Lengte omhulling [mm]
(28)	Altijd vernieuwen
(29)	Inbegrepen in 1888
(30)	Inbegrepen in 3483/3488
(31)	Inbegrepen in 3488
(32)	Binnendiameter [mm]
(33)	Op verzoek van klant met verschillende types koppelingen uitgevoerd
(34)	Kabellengte [mm]
(35)	Parameter
(36)	Kogellager
(37)	Koppelingsplaat met voordemper
(38)	Vermogen [kW]
(39)	Losse koppelingsplaat
(40)	Landuitvoering: Groot-Brittannië
(41)	Landuitvoering: Turkije
(42)	Lengte [mm]
(43)	Montagewijze: Niet voorgemonteerd
(44)	Montageset voor koppelingsdrukklager
(45)	Type motor
(46)	Naafprofiel
(47)	Naaldlager
(48)	ID power take-off
(49)	Alleen leverbaar bij teruggave van het oude onderdeel (reparatie; fabriek Bielefeld)

Vertalingen

(50) Alleen inbouwen als voertuig met M-koppeling uitgerust is

(51) Alleen samen inbouwen

(52) Productienummer

(53) Wielbasis [mm]

(54) Handgeschakelde versnellingsbak sequentieel

(55) Handgeschakelde versnellingsbak met automatische bediening

(56) Speciale uitvoering

(57) Starre koppelingsplaat

(58) Torsiegeveerde koppelingsplaat

(59) ZF-versnellingsbak

(60) Vanaf productienummer

(61) Alternatieve reparatieset

(63) Tot productienummer

(64) Bevat bevestigingsbouten drukgroep

(65) Bevat bevestigingsbouten vliegwiel

(66) Bevat één koppelingsplaat

(67) Bevat twee koppelingsplaten

(68) Voor

(69) Voor ontkoppelingsvork met nokken

(70) Voor ontkoppelingsvork met rollen

(71) Voor voertuigen met enkelvoudige plaatkoppeling

(72) Voor voertuigen met koppelingskrachtversterker

(73) Voor voertuigen met power take-off

(74) Voor voertuigen met lagedrukremstelsysteem

(75) Voor voertuigen met retarder

(76) Voor voertuigen met koppelomvormer-koppeling

(77) Voor voertuigen met tweevoudige plaatkoppeling

(78) Voor binnendiameter membraanveer 100 mm

(79) Voor binnendiameter membraanveer 120 mm

(80) Voor motoren met tweemassavliegwiel

(81) Voor motoren zonder tweemassavliegwiel

(82) Voor power take-off

(83) Voor OE-nummer

(84) Voor vliegwieldiepte [mm]

(85) Met verschillende types koppelingen uitgevoerd

(86) Lange beugel

(87) Max. overdraagbaar motorkoppel [Nm]

(88) Met aanloopring

(89) Met permanente smering

(90) Met retarder VR 115E

(91) Met smeerbuisaansluiting

(92) Met sensor

(93) Met tandkrans

(94) Met accessoires

(95) Met tussenring

(96) Niet voor

(97) Niet voor chassisnummer

(98) Niet voor motornummer

(99) Niet in combinatie met reservekoppelingsplaat

Vertalingen

(100) Alleen ter vervanging van vermelde OE-nr.

(101) Enkel in combinatie met

(102) Zonder aanloopring

(103) Zonder smeerbuisaansluiting

(104) Zonder sensor

(105) Zonder tussenring

DE

EN

FR

ES

PT

IT

NL

NO

SV

FI

PL

RU

HU

CS

RO

HR

EL

TR

ZH

DE

EN

FR

ES

PT

IT

NL

NO

SV

FI

PL

RU

HU

CS

RO

HR

EL

TR

ZH

Memo

Generelle opplysninger



Alle produkter i denne katalogen må kun monteres av personell ved et bilverksted med relevant utdanning.

For å kunne oppfylle dine krav trenger vi hele bestillingsnummeret, for eksempel:

Clutch-sett	3400 122 201
Clutchtrykkplate	3482 083 032
Clutchlamell	1878 004 832
Utløser	3151 000 034

Hvis en er i tvil må en angi typebetegnelse og byggeår til kjøretøyet, som ønsket artikkel er ment for.

Alle rettigheter forbeholdt. Kopiering eller felles bruk av denne katalogen, også delvis, for å opprette en egen katalog er forbudt uten skriftlig tillatelse.

Reservedelsnummer til kjøretøyprodusenter brukes for sammenligning. Det er ikke tillatt å bruke slik informasjon i fakturaer til kjøretøyets eier.

Aktuelle generelle vilkår og betingelser finner du på www.zf.com/services/documents

www.zf.com/services/catalog

WebCat
Nettkatalog

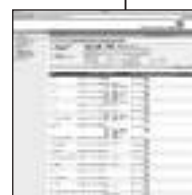

InCat
Elektronisk katalog



PrintCat
Trykte kataloger



Innholdsfortegnelse

Index	U2
Symboler	U3 - U4
Generelle opplysninger	V37
Katalogoppsett	V38
Prametere	V38
Oversettelser	V39 - V41
Aritmetisk liste	842 - 884
Sammenligningsliste	884 - 926
Nye oppføringer	927 - 928
Endret bestillingsnummer	929
Utgåtte numre	930
Måltabell for navprofiler	931
Måltabell for svinghjul	932 - 933

Katalogoppsett

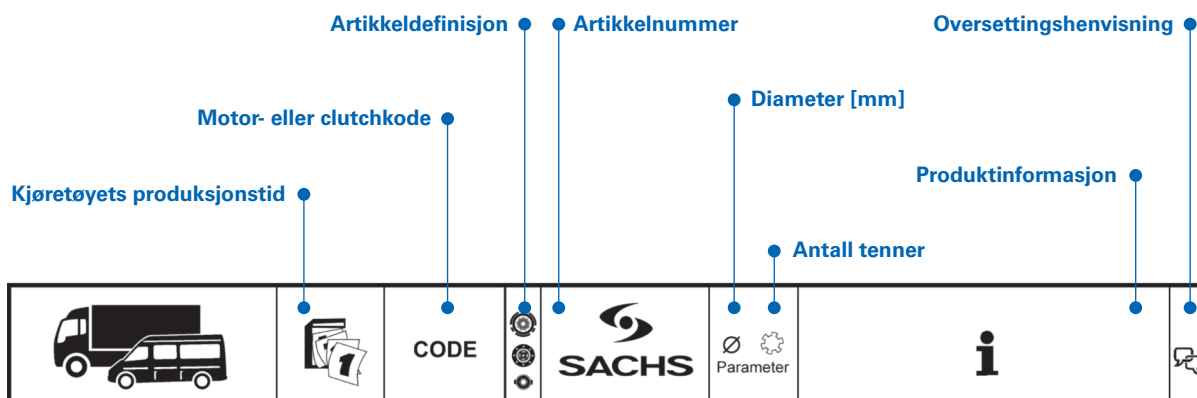

DAF

LF		10.13 -				
LF 180		PX-5135	3400 700 465 ● 3482 000 859 ● 1878 005 601 ● 3151 000 651	362 10 MF362 362WGTZ KZIS-4	Getr. / GBox: 6 S 700 Getr. / GBox: 6 AS 700 Abgasnorm: Euro 6 / Exhaust Emission Norm: Euro 6	(4)
			3400 700 464 ● 3482 000 859 ● 1878 005 600 ● 3151 000 651	362 10 MF362 362WGTZ KZIS-4	Getr. / GBox: 6 S 800 Getr. / GBox: 6 AS 800 Abgasnorm: Euro 6 / Exhaust Emission Norm: Euro 6	(4)
			3400 700 603 ● 3482 001 166 ● 1878 007 172 ● 3151 000 397	350 MF350 350WGTZ KZIS-4	Getr. / GBox: S5-42 Abgasnorm: Euro 6 / Exhaust Emission Norm: Euro 6	(4)
LF 210		PX-5157	3400 700 465 ● 3482 000 859 ● 1878 005 601 ● 3151 000 651	362 10 MF362 362WGTZ KZIS-4	Getr. / GBox: 6 S 700 Getr. / GBox: 6 AS 700 Abgasnorm: Euro 6 / Exhaust Emission Norm: Euro 6	(4)
			3400 700 464 ● 3482 000 859 ● 1878 005 600 ● 3151 000 651	362 10 MF362 362WGTZ KZIS-4	Getr. / GBox: 6 S 800 Getr. / GBox: 6 AS 800 Abgasnorm: Euro 6 / Exhaust Emission Norm: Euro 6	(4)
			3400 700 603 ● 3482 001 166 ● 1878 007 172 ● 3151 000 397	350 MF350 350WGTZ KZIS-4	Getr. / GBox: S5-42 Abgasnorm: Euro 6 / Exhaust Emission Norm: Euro 6	(4)

Prametere

Clutchtrykkplater

Z/	For dobbeltskiveutførelse
400	Friksjonsflatediameter 400 mm
Do	Dobbelclutch, avhengig utløsning
Du	Dobbelclutch, uavhengig utløsning
/E	XTend
F	Flatt svinghjul
G	Clutch med støpt hus
K	Skruefjærkobling
KM	Med membranfjær og spaksystem
M	Membranfjærkobling
N	Kraftuttak
S	Svingboltutførelse
T	Med fjærskive
XTend	Med automatisk justering
Z	Trekkfrigjøring

Clutchlameller

200	Utvendig diameter 200 mm
CE	Uorganisk sinterbelegg
B/D/E/Z	Koblingsfjærer
BH/GS/GT/GV	Torsjonsdemper for nyttekjøretøy
/E	XTend
W/V	Fordemper for nyttekjøretøy

Utløserlager

...A	Medløpende ytterring
G	Grafittløpering
GK	Grafittløpering og kulelager
GR	Kulelager med platekappe
GZ	Hovedsylinder
HHIS	Konsentrisk arbeidssylinder
...I	Medløpende innerring
KT	Teflonstartskive
KZ	Kulelager, sentralført
NZ	Arbeidssylinder
...S	Selvsentrerende innerring
...Z	Trekkfrigjøring

Øversettelser

(1)	Eksosnorm: Euro 3
(2)	Eksosnorm: Euro 4 (D4)
(3)	Eksosnorm: Euro 5
(4)	Eksosnorm: Euro 6
(5)	Eksosnorm: Euro 3 / Euro 4
(6)	Eksosnorm: Euro 4 / Euro 5
(7)	Eksosnorm: Euro 5 / Euro 6
(8)	Antall belegg
(9)	Utløsergaffel hengende [mm]
(10)	Utløsergaffel stående [mm]
(11)	Utvendig diameter [mm]
(12)	Byttedel erstattet av 3400 121 002
(13)	Ved støyproblemer
(14)	Inneholder utløser og monteringssett
(15)	Inneholder dobbelt massesvinghjul, trykkplate, clutchskive og utløser
(16)	Inneholder dobbelt massesvinghjul, trykkplate, clutchskive og CSC
(17)	Bensin
(18)	Bredde [mm]
(19)	Diesel
(20)	Kjøretøyet kan utstyres med forskjellige clutchstørrelser
(21)	Kjøretøyene kan ha forskjellige komponenter
(22)	Fuller-gir
(23)	Fyllemedium: Bremsvæske
(24)	Fyllemedium: Mineralolje
(25)	For eksport
(26)	Girnummer
(27)	Skallengde [mm]
(28)	Skiftes alltid
(29)	Inkludert i 1888
(30)	Inkludert i 3483/3488
(31)	Inkludert i 3488
(32)	Innvendig diameter [mm]
(33)	Alt etter kundens ønske utstyrt med forskjellig clutch
(34)	Kabellengde [mm]
(35)	Parameter
(36)	Kulelager
(37)	Clutchskive med fordemper
(38)	Effekt [kW]
(39)	Løs clutchlamell
(40)	Landsversjon: Storbritannia
(41)	Landsversjon: Tyrkia
(42)	Lengde [mm]
(43)	Monteringsmåte: Ikke forhåndsmontert
(44)	Monteringssett for utløserlager
(45)	Motormodell
(46)	Navprofil
(47)	Nålelager
(48)	Kraftuttaks-ID
(49)	Leveres kun ved retur av den gamle delen (reparasjon; fabrikk Bielefeld)

Översättelser

(50) Må kun monteres hvis kjøretøyet har en M-clutch

(51) Må kun monteres sammen

(52) Produksjonsnummer

(53) Akselavstand [mm]

(54) Manuell girkasse, sekvensiell

(55) Manuell girkasse, automatisert

(56) Spesialutførelse

(57) Stiv clutchlamell

(58) Torsjonsfjæret clutchlamell

(59) ZF-gir

(60) Fra produksjonsnummer

(61) Alternativt reparasjonssett

(63) Til produksjonsnummer

(64) Inneholder festeskruer til trykkplatene

(65) Inneholder festeskruer til svinghjul

(66) Inneholder én clutchlamell

(67) Inneholder to clutchlameller

(68) For

(69) For utløsergaffel med kam

(70) For utløsergaffel med ruller

(71) For kjøretøy med clutch med én lamell

(72) For kjøretøy med clutchkraftforsterker

(73) For kjøretøy med ekstra drev

(74) For kjøretøy med lavtrykk-bremsesystem

(75) For kjøretøy med retarder

(76) For kjøretøy med omformerclutch

(77) For kjøretøy med clutch med to lameller

(78) For membranfjær med innvendig diameter 100 mm

(79) For membranfjær med innvendig diameter 120 mm

(80) For motorer med todelt svinghjul

(81) For motorer uten todelt svinghjul

(82) For kraftuttak

(83) For OE-nummer

(84) For svinghjuldybde [mm]

(85) Alt etter modell utstyrt med forskjellig clutch

(86) Lang bøyle

(87) Maks. motormoment [Nm] som kan overføres

(88) Med trykkskive

(89) Med kontinuerlig smøring

(90) Med retarder VR 115E

(91) Med smørerørtilkobling

(92) Med sensor

(93) Med tannkrans

(94) Med tilbehør

(95) Med mellomring

(96) Ikke for

(97) Ikke for chassisnummer

(98) Ikke for motornummer

(99) Ikke i forbindelse med clutchskiver til utveksling

Översättelser

(100) Kun som erstatning for de angitte OE-nr.

(101) Kun i forbindelse med

(102) Uten trykkskive

(103) Uten smørerørtilkobling

(104) Uten sensor

(105) Uten mellomring

DE

EN

FR

ES

PT

IT

NL

NO

SV

FI

PL

RU

HU

CS

RO

HR

EL

TR

ZH

DE

EN

FR

ES

PT

IT

NL

NO

SV

FI

PL

RU

HU

CS

RO

HR

EL

TR

ZH

Memo

Allmän information



Alla produkter som anges i den här katalogen får endast monteras av behörig, utbildad personal i en bil-/fordonsverkstad.

För din förfrågan behöver vi det fullständiga beställningsnumret, till exempel:

Kopplingsats	3400 122 201
Kopplingstryckplatta	3482 083 032
Kopplingskiva	1878 004 832
Urtrampningsdon	3151 000 034

Om du är osäker, ange typbeteckning och årsmodell för det fordon som den önskade artikeln är avsedd för.

www.zf.com/services/catalog

WebCat
Online-katalog

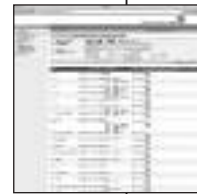

InCat
Elektronisk katalog



PrintCat
Tryckta kataloger



Innehållsförteckning

Index	U2
Symboler	U3 - U4
Allmän information	V43
Katalogstruktur	V44
Parametrar	V44
Översättningar	V45 - V47
Aritmetisk lista	842 - 884
Jämförelselista	884 - 926
Nyilagda	927 - 928
Ändrade beställningsnummer	929
Strukna nummer	930
Måttabell för navprofil	931
Måttabell för svänghjul	932 - 933

Alla rättigheter förbehålls. Mångfaldiganden eller med användning av den här katalogen, även utdragsvis, för framställning av en egen katalog är ej tillåtet utan uttryckligt godkännande.

Fordonstillverkarnas reservdelsnummer är endast till för jämförelse. Det är inte tillåtet att använda dylika uppgifter på fakturor till fordonsägarna.

De aktuella allmänna affärsvillkoren finns på www.zf.com/services/documents

Katalogstruktur

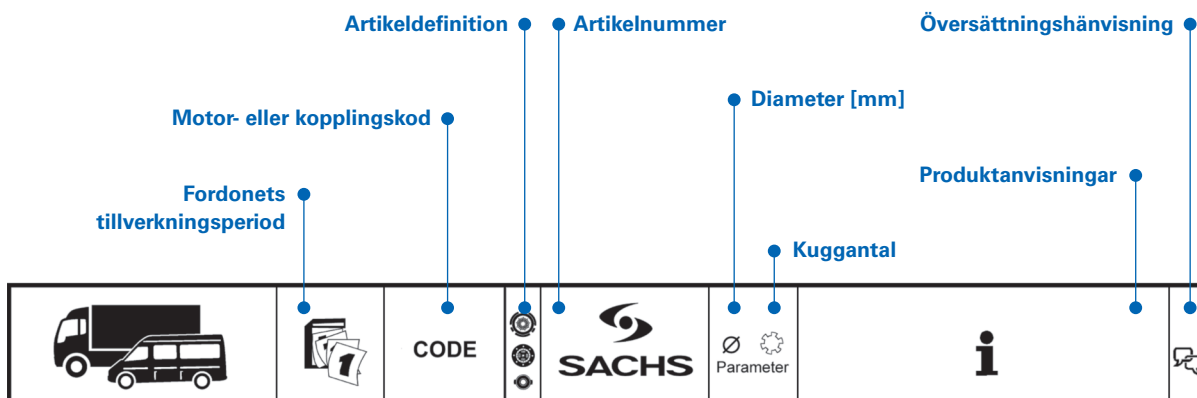

DAF

LF		10.13 -			
LF 180		PX-5135	3400 700 465 3482 000 859 1878 005 601 3151 000 651	362 10 MF362 362WGTZ KZIS-4	Getr. / GBox: 6 S 700 Getr. / GBox: 6 AS 700 Abgasnorm: Euro 6 / Exhaust Emission Norm: Euro 6 (4)
			3400 700 464 3482 000 859 1878 005 600 3151 000 651	362 10 MF362 362WGTZ KZIS-4	Getr. / GBox: 6 S 800 Getr. / GBox: 6 AS 800 Abgasnorm: Euro 6 / Exhaust Emission Norm: Euro 6 (4)
			3400 700 603 3482 001 166 1878 007 172 3151 000 397	350 MF350 350WGTZ KZIS-4	Getr. / GBox: S5-42 Abgasnorm: Euro 6 / Exhaust Emission Norm: Euro 6 (4)
LF 210		PX-5157	3400 700 465 3482 000 859 1878 005 601 3151 000 651	362 10 MF362 362WGTZ KZIS-4	Getr. / GBox: 6 S 700 Getr. / GBox: 6 AS 700 Abgasnorm: Euro 6 / Exhaust Emission Norm: Euro 6 (4)
			3400 700 464 3482 000 859 1878 005 600 3151 000 651	362 10 MF362 362WGTZ KZIS-4	Getr. / GBox: 6 S 800 Getr. / GBox: 6 AS 800 Abgasnorm: Euro 6 / Exhaust Emission Norm: Euro 6 (4)
			3400 700 603 3482 001 166 1878 007 172 3151 000 397	350 MF350 350WGTZ KZIS-4	Getr. / GBox: S5-42 Abgasnorm: Euro 6 / Exhaust Emission Norm: Euro 6 (4)

Parametrar

Kopplingstryckplattor

Z/	För utförande med dubbelskivor
400	Ytterdiameter rivyta 400 mm
Do	Dubbelkoppling, beroende urkoppling
Du	Dubbelkoppling, oberoende urkoppling
/E	XTend
F	Platt svänghjul
G	Koppling med gjutet hus
K	Skruvfjäderkoppling
KM	Med membranfjäder och spaksystem
M	Membranfjäderkoppling
N	Kraftuttag
S	Vridtappsutförande
T	Med fjäderbricka
XTend	Med automatisk justering
Z	Urkoppling på drag

Kopplingsskivor

200	Utvändig diameter 200 mm
CE	Oorganisk sintrad beläggning
B/D/E/Z	Beläggingsfjädrar
BH/GS/GT/GV	Torsionsdämpare för nyttofordon
/E	XTend
W/V	Fördämpare för nyttofordon

Urkopplingslager

...A	Yttering medlöpande
G	Tryckring av grafit
GK	Tryckring av grafit och kullager
GR	Kullager med plåtkåpa
GZ	Huvudcylinder
HHIS	Koncentrisk slavcylinder
...I	Inre ring medlöpande
KT	Teflonlöpskiva
KZ	Kullager, centralstyrt
NZ	Slavcylinder
...S	Självcenterande inre ring
...Z	Urkoppling på drag

Översättningar

(1)	Utsläppsnorm: Euro 3
(2)	Utsläppsnorm: Euro 4 (D4)
(3)	Utsläppsnorm: Euro 5
(4)	Utsläppsnorm: Euro 6
(5)	Utsläppsnorm: Euro 3 / Euro 4
(6)	Utsläppsnorm: Euro 4 / Euro 5
(7)	Utsläppsnorm: Euro 5 / Euro 6
(8)	Antal beläggningar
(9)	Urkopplingsgaffel, hängande [mm]
(10)	Urkopplingsgaffel, stående [mm]
(11)	Ytterdiameter [mm]
(12)	Reservdel utbytt mot 3400 121 002
(13)	Vid ljudproblem
(14)	Innehåller urtrampningsdon och monteringsats
(15)	Innehåller dubbelmassesvänghjul, tryckplatta, kopplingslamell och urtrampningsdon
(16)	Innehåller dubbelmassesvänghjul, tryckplatta, kopplingslamell och CSC
(17)	Bensin
(18)	Bredd [mm]
(19)	Diesel
(20)	Fordonet kan utrustas med olika kopplingsstorlekar
(21)	Fordonen kan vara utrustade med olika komponenter
(22)	Fuller-transmission
(23)	Påfyllningsmedium: Bromsvätska
(24)	Påfyllningsmedium: Mineralolja
(25)	För export
(26)	Transmissionsnummer
(27)	Höljets längd [mm]
(28)	Skall alltid bytas
(29)	Ingår i 1888
(30)	Ingår i 3483/3488
(31)	Ingår i 3488
(32)	Invändig diameter [mm]
(33)	Olika kopplingar, beroende på kundens önskemål
(34)	Kabellängd [mm]
(35)	Parameter
(36)	Kullager
(37)	Kopplingslamell med fördämpare
(38)	Effekt [kW]
(39)	Lös kopplingsskiva
(40)	Landversion: Storbritannien
(41)	Landversion: Turkiet
(42)	Längd [mm]
(43)	Monteringssätt: Ej förmonterat
(44)	Monteringssats för urkopplingslager
(45)	Motortyp
(46)	Navprofil
(47)	Nållager
(48)	ID extra drivkraft
(49)	Kan endast levereras vid retur av kasserad del (reparation; fabriken i Bielefeld)

Översättningar

(50) Får endast monteras om fordonet är utrustat med M-koppling

(51) Får bara monteras tillsammans

(52) Produktionsnummer

(53) Hjulbas [mm]

(54) Växellåda, sekventiell

(55) Växellåda, automatisk utlösning

(56) Specialutförande

(57) Stel kopplingskiva

(58) Torsionsfjädrad kopplingskiva

(59) ZF-transmission

(60) Från produktionsnummer

(61) Alternativ reparationssett

(63) Till produktionsnummer

(64) Innehåller fästskruvar för tryckplatta

(65) Innehåller fästskruvar för svänghjul

(66) Innehåller en kopplingskiva

(67) Innehåller två kopplingskivor

(68) För

(69) För urkopplingsgaffel med kam

(70) För urkopplingsgaffel med rullar

(71) För fordon med enkellamellkoppling

(72) För fordon med kopplingskraftförstärkare

(73) För fordon med kraftuttag

(74) För fordon med lågtrycks-bromssystem

(75) För fordon med retarder

(76) För fordon med momentomvandlare

(77) För fordon med dubbellamellkoppling

(78) För membranfjäderinnerdiameter 100 mm

(79) För membranfjäderinnerdiameter 120 mm

(80) För motorer med tvåmassesvänghjul

(81) För motorer utan tvåmassesvänghjul

(82) För kraftuttag

(83) För OE-nummer

(84) För svänghjulsdjup [mm]

(85) Olika kopplingar beroende på modell

(86) Lång bygel

(87) Max. överförbart motorvridmoment [Nm]

(88) Med tryckring

(89) Med permanent smörjning

(90) Med retarder VR 115E

(91) Med smörjrörsanslutning

(92) Med sensor

(93) Med kuggkrans

(94) Med tillbehör

(95) Med mellanläggsbricka

(96) Ej för

(97) Ej för chassinummer

(98) Ej för motornummer

(99) Ej i kombination med reservkopplingskiva

Översättningar

(100) Enbart som ersättning för angivet OE-nr.

(101) Endast i samband med

(102) Utan tryckring

(103) Utan smörjrörsanslutning

(104) Utan sensor

(105) Utan mellanläggsbricka

DE

EN

FR

ES

PT

IT

NL

NO

SV

FI

PL

RU

HU

CS

RO

HR

EL

TR

ZH

DE

EN

FR

ES

PT

IT

NL

NO

SV

FI

PL

RU

HU

CS

RO

HR

EL

TR

ZH

Memo

Yleiset tiedot



Kaikki tässä luettelossa mainitut tuotteet saa asentaa vain autokorjaamon koulutettu henkilöstö.

Vaativuusi varten tarvitsemme täydellisen tilausnumeron, esimerkiksi:

Kytkinsarja	3400 122 201
Kytkinasennelma	3482 083 032
Kytkinlevy	1878 004 832
Irrotin	3151 000 034

Epävarmoissa tapauksissa ilmoita sen auton tyyppinimike ja vuosimalli, johon haluttu tuote on tarkoitettu.

Kaikki oikeudet pidätetään. Tämän luettelon osittainenkin monistaminen tai käyttäminen oman luettelon laatimiseen on ilman nimenomaista lupaa kiellettyä.

Ajoneuvojen valmistajien varaosanumerot on tarkoitettu vain vertailutarkoituksiin. Tällaisten tietojen käyttö auton omistajalle menevissä laskuissa ei ole sallittua.

Voimassa olevat yleiset myyntiehdot löytyvät osoitteesta www.zf.com/services/documents

www.zf.com/services/catalog

WebCat

Online-luettelo



InCat

Sähköinen luettelo



PrintCat

Painetut luettelot



Sisällysluettelo

Index	U2
Symbolit	U3 - U4
Yleiset tiedot	V49
Luettelon rakenne	V50
Tunnusluvut	V50
Käännökset	V51 - V53
Aritmeettinen lista	842 - 884
Vertailulista	884 - 926
Uudelleen vastaanotetut	927 - 928
Muutettu tilausnumero	929
Pyyhityt numerot	930
Mittataulukko navan urituksille	931
Mittataulukko vauhtipyörille	932 - 933

Luettelon rakenne

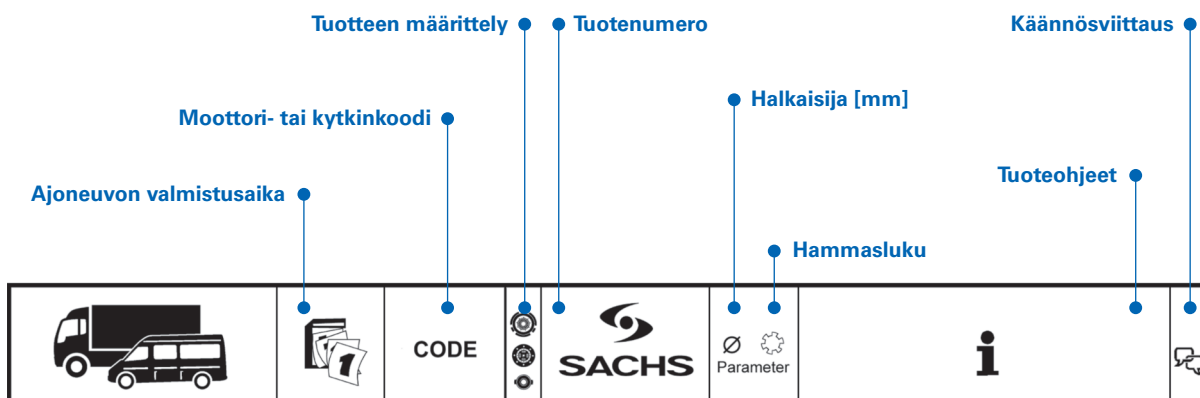

DAF

LF		10.13 -	
LF 180	PX-5135	3400 700 465 3482 000 859 1878 005 601 3151 000 651	362 10 MF362 362WGTZ KZIS-4 Getr. / GBox: 6 S 700 Getr. / GBox: 6 AS 700 Abgasnorm: Euro 6 / Exhaust Emission Norm: Euro 6 (4)
		3400 700 464 3482 000 859 1878 005 600 3151 000 651	362 10 MF362 362WGTZ KZIS-4 Getr. / GBox: 6 S 800 Getr. / GBox: 6 AS 800 Abgasnorm: Euro 6 / Exhaust Emission Norm: Euro 6 (4)
		3400 700 603 3482 001 166 1878 007 172 3151 000 397	350 MF350 350WGTZ KZIS-4 Getr. / GBox: S5-42 Abgasnorm: Euro 6 / Exhaust Emission Norm: Euro 6 (4)
LF 210	PX-5157	3400 700 465 3482 000 859 1878 005 601 3151 000 651	362 10 MF362 362WGTZ KZIS-4 Getr. / GBox: 6 S 700 Getr. / GBox: 6 AS 700 Abgasnorm: Euro 6 / Exhaust Emission Norm: Euro 6 (4)
		3400 700 464 3482 000 859 1878 005 600 3151 000 651	362 10 MF362 362WGTZ KZIS-4 Getr. / GBox: 6 S 800 Getr. / GBox: 6 AS 800 Abgasnorm: Euro 6 / Exhaust Emission Norm: Euro 6 (4)
		3400 700 603 3482 001 166 1878 007 172 3151 000 397	350 MF350 350WGTZ KZIS-4 Getr. / GBox: S5-42 Abgasnorm: Euro 6 / Exhaust Emission Norm: Euro 6 (4)

Tunnusluvut

Kytkinasennelmat	
Z/	Kaksikammioiseen malliin
400	Kitkapinnan ulkohalkaisija 400 mm
Do	Kaksoiskytkin, riippuvainen irrotus
Du	Kaksoiskytkin, riippumaton irrotus
/E	XTend
F	Litteä vauhtipyörä
G	Kytkin valetulla rungolla
K	Kierrejousiskytkin
KM	Kalvojosella ja vipujärjestelmällä
M	Kalvojosiskytkin
N	Voiman ulosotto
S	Kääntöpulttivarustus
T	Lautasjosella
XTend	Automaattisella säädöllä
Z	Irrotus vetämällä

Kytkinlevyt	
200	Ulkohalkaisija 200 mm
CE	Epäorgaaninen sintterilevy
B/D/E/Z	Levyjousitukset
BH/GS/GT/GV	Vääntövaimennin hyötyajoneuvoon
/E	XTend
W/V	Esivaimennin hyötyajoneuvoon

Irrotinlaakeri	
...A	Ulkorengas samaan suuntaan kulkeva
G	Grafiittirengas
GK	Grafiittirengas ja kuulalaakeri
GR	Kuulalaakeri peltikannella
GZ	Pääsylinteri
HHIS	Konsentrinen työsylinteri
...I	Sisärengas samaan suuntaan kulkeva
KT	Teflonpainelevy
KZ	Kuulalaakeri, keskusohjattu
NZ	Työsylinteri
...S	Itsestään keskittyvä sisärengas
...Z	Irrotus vetämällä

Käännökset

(1)	Pakokaasupäästöjä koskeva standardi: Euro 3
(2)	Pakokaasupäästöjä koskeva standardi: Euro 4 (D4)
(3)	Pakokaasupäästöjä koskeva standardi: Euro 5
(4)	Pakokaasupäästöjä koskeva standardi: Euro 6
(5)	Pakokaasupäästöjä koskeva standardi: Euro 3 / Euro 4
(6)	Pakokaasupäästöjä koskeva standardi: Euro 4 / Euro 5
(7)	Pakokaasupäästöjä koskeva standardi: Euro 5 / Euro 6
(8)	Pintojen määrä
(9)	Irrotinhaarukka riippuva [mm]
(10)	Irrotinhaarukka pystyssä [mm]
(11)	Ulkohalkaisija [mm]
(12)	Vaihdettava osa, jonka korvaa 3400 121 002
(13)	Häiriöääniongelmassa
(14)	Sisältää irrotin ja asennussarjan
(15)	Sisältää kaksoismassavauhtipyörän, kytkimen painelevyn, kytkinlevyn ja irrotinlaakerin
(16)	Sisältää kaksoismassavauhtipyörän, kytkimen painelevyn, kytkinlevyn ja CSC:n
(17)	Bensiini
(18)	Leveys [mm]
(19)	Diesel
(20)	Ajoneuvo voi olla varustettu erikokoisilla kytkimillä
(21)	Ajoneuvot voivat olla varustettuja erilaisilla komponenteilla
(22)	Fuller-vaihteisto
(23)	Täyttöaine: Jarruneste
(24)	Täyttöaine: Mineraaliöljy
(25)	Vientiin
(26)	Vaihteistonumero
(27)	Suojuksen pituus [mm]
(28)	Uusittava aina
(29)	Malleissa 1888 mukana
(30)	Malleissa 3483/3488 mukana
(31)	Malleissa 3488 mukana
(32)	Sisähalkaisija [mm]
(33)	Varustettu erilaisella kytkimellä asiakkaan toivomuksen mukaisesti
(34)	Johtopituus [mm]
(35)	Tunnusluku
(36)	Kuulalaakeri
(37)	Kytkinlevy esivaimentimella
(38)	Teho [kW]
(39)	Avoin kytkinlevy
(40)	Maaversio: Iso-Britannia
(41)	Maaversio: Turkki
(42)	Pituus [mm]
(43)	Asennustapa: Ei esiasennettu
(44)	Asennussarja irrotinlaakerille
(45)	Moottorimalli
(46)	Navan uritus
(47)	Neulalaakeri
(48)	Voiman ulosoton tunniste
(49)	Toimitettavissa vain käytetyn osan palautuksen kanssa (korjaus; Bielefeldin tehdas)

Käännökset

(50) Asennettavissa vain, jos ajoneuvossa on M-kytkin

(51) Asennettava yhdessä

(52) Valmistenumero

(53) Akseliväli [mm]

(54) Käsivaihteisto peräkkäinen

(55) Käsivaihteisto, automatisoitu

(56) Erikoismalli

(57) Jäykkä kytkinlevy

(58) Jousivaimenteinen kytkinlevy

(59) ZF-vaihteisto

(60) Alkaen valmistusnumerosta

(61) Vaihtoehtoinen korjaussarja

(63) Päätyen valmistenumeroon

(64) Sisältää painelevyn kiinnitysruuvit

(65) Sisältää vauhtipyörän kiinnitysruuvit

(66) Sisältää yhden kytkinlevyn

(67) Sisältää kaksi kytkinlevyä

(68) Käyttö

(69) Irrotinhaarukka, jossa nokka

(70) Irrotinhaarukka, jossa rullat

(71) Ajoneuvot, joissa yksilevykytkin

(72) Ajoneuvot, joissa kytkintehostin

(73) Ajoneuvot, joissa voimanottolaitteella

(74) Ajoneuvot, joissa matalapaineinen jarrujärjestelmä

(75) Ajoneuvot, joissa hidastin

(76) Ajoneuvot, joissa nestekytkin

(77) Ajoneuvot, joissa kaksilevykytkin

(78) Membraanijouselle, sisähalkaisija 100 mm

(79) Membraanijouselle, sisähalkaisija 120 mm

(80) Moottorit, joissa kaksimassavauhtipyörä

(81) Moottorit, ilman kaksimassavauhtipyörää

(82) Voiman ulosotto

(83) Alkuperäisnumero

(84) Vauhtipyörän syvyys [mm]

(85) Varustettu erilaisella kytkimellä mallin mukaisesti

(86) Pitkä sanko

(87) Maks. siirrettävä vääntömomentti [Nm]

(88) Vasterenkaalla

(89) Kestovoitelulla

(90) Hidastimella VR 115E

(91) Voiteluputkiliitännällä

(92) Anturilla

(93) Hammaskehällä

(94) Varusteilla

(95) Välipainelevyllä

(96) Paitsi

(97) Paitsi alustanumerolle

(98) Paitsi moottorinumerot

(99) Ei yhdessä vaihdettavan kytkinlevyn kanssa

Käännökset

(100) Vain lueteltujen alkuperäisnumeroiden tilalle

(101) Vain yhdessä

(102) Ilman vasterengasta

(103) Ilman voiteluputkiliitäntää

(104) Ilman anturia

(105) Ilman välipainerengasta

DE

EN

FR

ES

PT

IT

NL

NO

SV

FI

PL

RU

HU

CS

RO

HR

EL

TR

ZH

DE

EN

FR

ES

PT

IT

NL

NO

SV

FI

PL

RU

HU

CS

RO

HR

EL

TR

ZH

Memo

Ogólna informacja



Wszystkie produkty wymienione w tym katalogu mogą być montowane wyłącznie przez wykwalifikowany personel serwisu samochodowego.

W przypadku zamówień niezbędny jest pełny numer zamówieniowy, na przykład:

Zestaw sprzęgowy	3400 122 201
Tarcza dociskowa sprzęgła	3482 083 032
Tarcza sprzęgła	1878 004 832
Wyprzęgnik	3151 000 034

W razie wątpliwości proszę podawać oznaczenie typu i rok produkcji pojazdu, dla którego przeznaczony jest żądany artykuł.

Wszelkie prawa zastrzeżone. Powielanie lub wykorzystywanie niniejszego katalogu, w całości lub częściowo, do sporządzenia innego katalogu jest niedozwolone bez uzyskania wyraźnej zgody. Numery części zamiennych producentów samochodów służą tylko do celów porównawczych.

Wykorzystywanie tego rodzaju danych na rachunkach wystawianych pod adresem posiadacza samochodu jest zabronione.

Aktualne ogólne warunki handlowe można znaleźć tutaj www.zf.com/services/documents

www.zf.com/services/catalog

WebCat
Katalog online

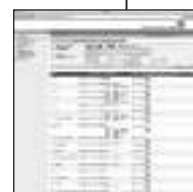

InCat
Katalog elektroniczny



PrintCat
Drukowane katalogi



Spis treści

Index	U2
Symbole	U5 - U6
Ogólna informacja	V55
Struktura katalogu	V56
Parametry	V56
Tłumaczenia	V57 - V59
Lista z numerami	842 - 884
Lista porównawcza	884 - 926
Nowe produkty	927 - 928
Zmieniony numer części	929
Numerы skreślone	930
Tabela wymiarów profili piasty	931
Tabela wymiarów tarcz zamachowych	932 - 933

Struktura katalogu

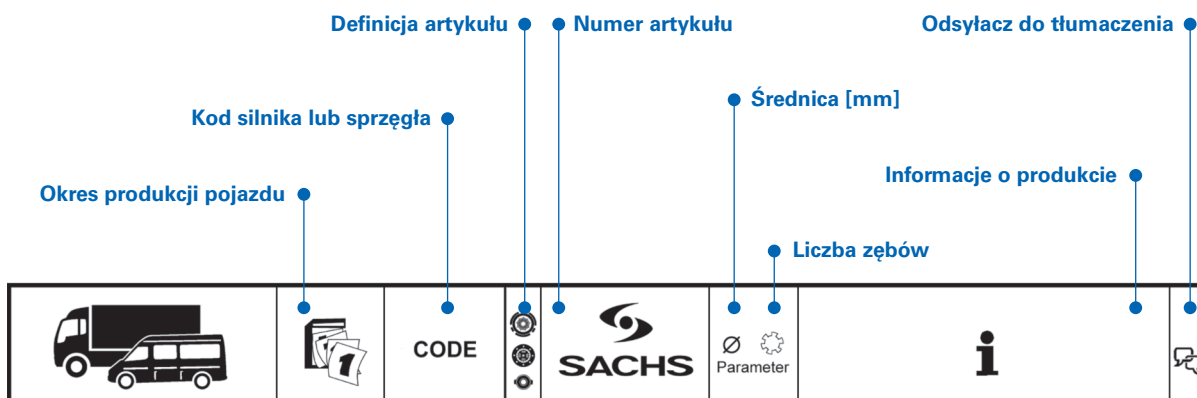

DAF

LF		10.13 -				
LF 180		PX-5135	3400 700 465 3482 000 859 1878 005 601 3151 000 651	362 10 MF362 362WGTZ KZIS-4	Getr. / GBox: 6 S 700 Getr. / GBox: 6 AS 700 Abgasnorm: Euro 6 / Exhaust Emission Norm: Euro 6	(4)
			3400 700 464 3482 000 859 1878 005 600 3151 000 651	362 10 MF362 362WGTZ KZIS-4	Getr. / GBox: 6 S 800 Getr. / GBox: 6 AS 800 Abgasnorm: Euro 6 / Exhaust Emission Norm: Euro 6	(4)
			3400 700 603 3482 001 166 1878 007 172 3151 000 397	350 MF350 350WGTZ KZIS-4	Getr. / GBox: S5-42 Abgasnorm: Euro 6 / Exhaust Emission Norm: Euro 6	(4)
LF 210		PX-5157	3400 700 465 3482 000 859 1878 005 601 3151 000 651	362 10 MF362 362WGTZ KZIS-4	Getr. / GBox: 6 S 700 Getr. / GBox: 6 AS 700 Abgasnorm: Euro 6 / Exhaust Emission Norm: Euro 6	(4)
			3400 700 464 3482 000 859 1878 005 600 3151 000 651	362 10 MF362 362WGTZ KZIS-4	Getr. / GBox: 6 S 800 Getr. / GBox: 6 AS 800 Abgasnorm: Euro 6 / Exhaust Emission Norm: Euro 6	(4)
			3400 700 603 3482 001 166 1878 007 172 3151 000 397	350 MF350 350WGTZ KZIS-4	Getr. / GBox: S5-42 Abgasnorm: Euro 6 / Exhaust Emission Norm: Euro 6	(4)

Parametry

Tarcze dociskowe sprzęgła	
Z/	Do wersji z dwoma tarczami
400	Średnica zewnętrzna powierzchni tarcia 400 mm
Do	Podwójne sprzęgło, wyprężanie zależne
Du	Podwójne sprzęgło, wyprężanie niezależne
/E	XTend
F	Płaskie koło zamachowe
G	Sprzęgło z odlewaną obudową
K	Sprzęgło ze sprężyną śrubową
KM	Z sprężyną membranową i systemem dźwigniowym
M	Sprzęgło ze sprężyną membranową
N	Napęd dodatkowy
S	Wersja ze sworzniem obrotowym
T	Z sprężyną talerzową
XTend	Z automatycznym nastawianiem
Z	Wyprężanie z ciągnem

Tarcza sprzęgła	
200	Średnica zewnętrzna 200 mm
CE	Nieorganiczna powłoka spiekana
B/D/E/Z	Elastyczne okładziny
BH/GS/GT/GV	Tłumiki drgań skrętnych dla pojazdów użytkowych
/E	XTend
W/V	Tłumiki wstępne dla pojazdów użytkowych

Łożysko wyciskowe	
...A	Pierścień zewnętrzny współbieżny
G	Pierścień oporowy grafitowy
GK	Pierścień oporowy grafitowy i łożysko kulkowe
GR	Łożysko kulkowe z osłoną blaszaną
GZ	Pompa sprzęgłowa
HHIS	Koncentryczny cylinder odbiorczy
...I	Pierścień wewnętrzny współbieżny
KT	Teflonowa podkładka oporowa
KZ	Łożysko kulkowe, prowadzone centralnie
NZ	Cylinder odbiorczy
...S	Pierścień wewnętrzny samocentrujący
...Z	Wyprężanie z ciągnem

Tłumaczenia

(1)	Norma emisji spalin: Euro 3
(2)	Norma emisji spalin: Euro 4 (D4)
(3)	Norma emisji spalin: Euro 5
(4)	Norma emisji spalin: Euro 6
(5)	Norma emisji spalin: Euro 3 / Euro 4
(6)	Norma emisji spalin: Euro 4 / Euro 5
(7)	Norma emisji spalin: Euro 5 / Euro 6
(8)	Liczba okładzin
(9)	Widelki wyprzęgające, wiszące [mm]
(10)	Widelki wyprzęgające, stojące [mm]
(11)	Średnica zewnętrzna [mm]
(12)	Część wymienna zamieniona na 3400 121 002
(13)	W razie problemów z niepożądanymi odgłosami
(14)	Zawiera wyprzęgnik i zestaw montażowy
(15)	Zawiera koło dwumasowe, tarczę dociskową, tarczę sprzęgła i wyprzęgnik
(16)	Zawiera koło dwumasowe, tarczę dociskową, tarczę sprzęgła i CSC
(17)	Benzyna
(18)	Szerokość [mm]
(19)	Diesel
(20)	Pojazd może zostać wyposażony w sprzęgła o różnej wielkości
(21)	Pojazdy mogą być wyposażone w różne komponenty
(22)	Przekładnia Fullera
(23)	Czynnik wypełniający: Płyn hamulcowy
(24)	Czynnik wypełniający: Olej mineralny
(25)	Na eksport
(26)	Numer przekładni
(27)	Długość osłony [mm]
(28)	Zawsze wymieniać
(29)	Zawarte w 1888
(30)	Zawarte w 3483/3488
(31)	Zawarte w 3483
(32)	Średnica wewnętrzna [mm]
(33)	Wyposażone w różne sprzęgła według życzenia klienta
(34)	Długość przewodu [mm]
(35)	Parametry
(36)	Łożysko kulkowe
(37)	Tarcza sprzęgła ze wstępnym tłumikiem drgań
(38)	Moc [kW]
(39)	Wolna tarcza sprzęgła
(40)	Wersja krajowa: Wielka Brytania
(41)	Wersja krajowa: Turcja
(42)	Długość [mm]
(43)	Rodzaj montażu: Niezamontowany wstępnie
(44)	Zestaw do montażu łożyska wyprzęgnika
(45)	Typ silnika
(46)	Profil piasty
(47)	Łożysko igiełkowe
(48)	ID napędu dodatkowego
(49)	Dostępne tylko w przypadku zwrotu zużytej części (naprawa; zakład Bielefeld)

Переводы

(50) Montować tylko wtedy, gdy pojazd jest wyposażony w sprzęgło M

(51) Montować tylko razem

(52) Numer seryjny

(53) Rozstaw kół [mm]

(54) Sekwencyjna skrzynia biegów

(55) Automatyczną skrzynia biegów

(56) Wersja specjalna

(57) Nieruchoma tarcza sprzęgła

(58) Tarcza sprzęgła z tłumikiem drgań skrętnych

(59) Przekładnia ZF

(60) Od numeru seryjnego

(61) Alternatywny zestaw naprawczy

(63) Do numeru seryjnego

(64) Zawiera śruby do mocowania tarczy dociskającej

(65) Zawiera śruby do mocowania koła zamachowego

(66) Zawiera jedną tarczę sprzęgła

(67) Zawiera dwie tarcze sprzęgła

(68) Do

(69) Do widełek wyprzęgających z krzywką

(70) Do widełek wyprzęgających z rolkami

(71) Do pojazdów z sprzęgłem jednotarczowym

(72) Do pojazdów z siłownikiem sprzęgła

(73) Do pojazdów z napędem pomocniczym

(74) Do pojazdów z niskociśnieniowym układem hamulcowym

(75) Do pojazdów z retarderem

(76) Do pojazdów z przekładnią hydrokinetyczną ze sprzęgłem ciernym

(77) Do pojazdów z sprzęgłem dwutarczowym

(78) Do sprężyny membranowej o średnicy wewnętrznej 100 mm

(79) Do sprężyny membranowej o średnicy wewnętrznej 120 mm

(80) Do silników z podwójnym kołem zamachowym

(81) Do silników bez podwójnego koła zamachowego

(82) Do napędu dodatkowego

(83) Do numeru OE

(84) Do koła zamachowego o głębokości [mm]

(85) W zależności od wykonania z różnymi sprzęgłami

(86) Długi kabłąk

(87) Maks. przenoszony moment silnika [Nm]

(88) Z pierścieniem rozruchowym

(89) Z smarowaniem długoterminowym

(90) Z retarderem VR 115E

(91) Z przyłączem rury smarowania

(92) Z czujnikiem

(93) Z wieńcem zębatym

(94) Z wyposażeniem

(95) Z pierścieniem pośrednim

(96) Nie do

(97) Nie do podwozi o numerze

(98) Nie do silników o numerze

(99) Nie w połączeniu z wymienną tarczą sprzęgła

Переводы

(100) Tylko jako zamiennik dla podanego nr OE

(101) Tylko w połączeniu z

(102) Bez pierścienia rozruchowego

(103) Bez przyłącza rury smarowania

(104) Bez czujnika

(105) Bez pierścienia pośredniego

DE

EN

FR

ES

PT

IT

NL

NO

SV

FI

PL

RU

HU

CS

RO

HR

EL

TR

ZH

DE

EN

FR

ES

PT

IT

NL

NO

SV

FI

PL

RU

HU

CS

RO

HR

EL

TR

ZH

Memo

Общая информация



Все приведенные в данном каталоге продукты разрешается устанавливать только обученному персоналу автомобильной мастерской.

Для удовлетворения вашего запроса нам необходим полный номер для заказа, например:

Комплект сцепления	3400 122 201
Нажимной диск сцепления	3482 083 032
Ведомый диск сцепления	1878 004 832
Выжимной подшипник	3151 000 034

В случае сомнений необходимо указать обозначение типа и год выпуска автомобиля, для которого предназначено заказываемое изделие.

Все права защищены. Копирование либо совместное использование данного каталога в том числе частичное для составления собственного каталога недопустимо без особого на то согласия.

Номера запасных частей производителей автомобилей указаны исключительно в целях сравнения. Использование подобных данных в счетах, выставляемых владельцам автомобилей, недопустимо.

Действующие общие условия заключения сделок приведены на сайте www.zf.com/services/documents

www.zf.com/services/catalog

WebCat

Онлайн-каталог

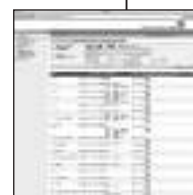

InCat

Электронный каталог



PrintCat

Печатные каталоги



Оглавление

Index	U2
Символы	U5 - U6
Общая информация	V61
Структура каталога	V62
Характеристики	V62
Переводы	V63 - V65
Арифметический список	842 - 884
сравнительная таблица	884 - 926
Новинки	927 - 928
Измененный номер для заказа	929
Зачеркнутые номера	930
Таблица размеров профилей ступиц	931
Таблица размеров дисковых маховиков	932 - 933

Структура каталога

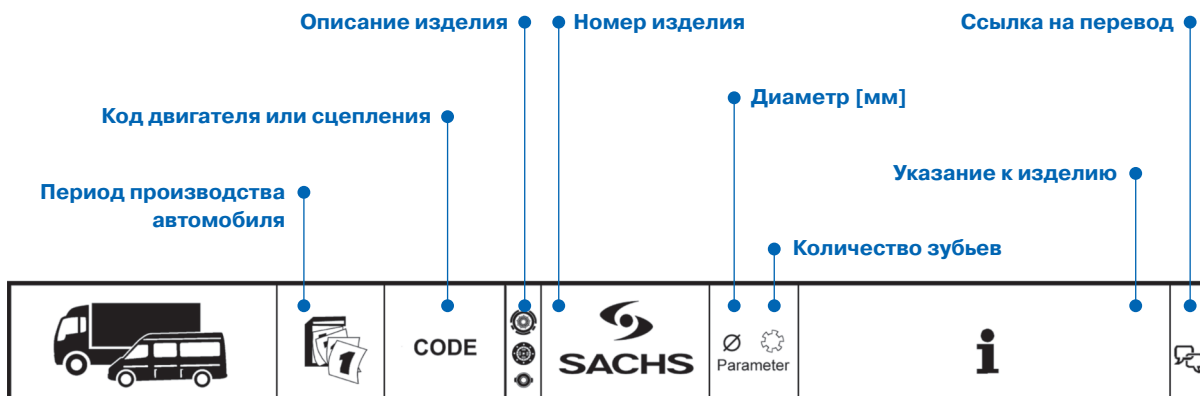

DAF

LF		10.13 -	
LF 180	PX-5135	3400 700 465 3482 000 859 1878 005 601 3151 000 651	362 10 MF362 362WGTZ KZIS-4 Getr. / GBox: 6 S 700 Getr. / GBox: 6 AS 700 Abgasnorm: Euro 6 / Exhaust Emission Norm: Euro 6 (4)
		3400 700 464 3482 000 859 1878 005 600 3151 000 651	362 10 MF362 362WGTZ KZIS-4 Getr. / GBox: 6 S 800 Getr. / GBox: 6 AS 800 Abgasnorm: Euro 6 / Exhaust Emission Norm: Euro 6 (4)
		3400 700 603 3482 001 166 1878 007 172 3151 000 397	350 MF350 350WGTZ KZIS-4 Getr. / GBox: S5-42 Abgasnorm: Euro 6 / Exhaust Emission Norm: Euro 6 (4)
LF 210	PX-5157	3400 700 465 3482 000 859 1878 005 601 3151 000 651	362 10 MF362 362WGTZ KZIS-4 Getr. / GBox: 6 S 700 Getr. / GBox: 6 AS 700 Abgasnorm: Euro 6 / Exhaust Emission Norm: Euro 6 (4)
		3400 700 464 3482 000 859 1878 005 600 3151 000 651	362 10 MF362 362WGTZ KZIS-4 Getr. / GBox: 6 S 800 Getr. / GBox: 6 AS 800 Abgasnorm: Euro 6 / Exhaust Emission Norm: Euro 6 (4)
		3400 700 603 3482 001 166 1878 007 172 3151 000 397	350 MF350 350WGTZ KZIS-4 Getr. / GBox: S5-42 Abgasnorm: Euro 6 / Exhaust Emission Norm: Euro 6 (4)

Характеристики

Нажимные диски сцепления

Z/	Для исполнения с двумя шайбами
400	Наружный диаметр поверхности трения 400 мм
Do	Двойное сцепление, зависимое выключение
Du	Двойное сцепление, независимое выключение
/E	XTend
F	Плоский маховик
G	Сцепление с литым картером
K	Сцепление с витой пружиной
KM	С мембранной пружиной и системой рычагов
M	Сцепление с мембранной пружиной
N	Механизм отбора мощности
S	Исполнение откидного болта
T	С тарельчатой пружиной
XTend	С автоматической регулировкой
Z	Выключение при обратном выжиме

Ведомые диски сцепления

200	Наружный диаметр 200 мм
CE	Накладка из неорганического спеченного материала
B/D/E/Z	Подпружинивание накладки
BH/GS/GT/GV	Гасители крутильных колебаний для грузовых а/м
/E	XTend
W/V	Первичный гаситель для грузовых а/м

Выжимной подшипник

...A	Наружное кольцо, вращающееся совместно
G	Графитовое упорное кольцо
GK	Графитовое упорное кольцо и шарикоподшипник
GR	Шарикоподшипник с колпачком
GZ	Главный цилиндр
HNIS	Концентрический рабочий цилиндр
...I	Внутреннее кольцо, вращающееся совместно
KT	Тефлоновая регулировочная шайба
KZ	Шарикоподшипник, с центральным направлением
NZ	Рабочий цилиндр
...S	Самоцентрирующееся внутреннее кольцо
...Z	Выключение при обратном выжиме

Переводы

- (1) Нормы токсичности отработавших газов: Евро-3
- (2) Нормы токсичности отработавших газов: Евро-4 (D4)
- (3) Нормы токсичности отработавших газов: Евро-5
- (4) Нормы токсичности отработавших газов: Евро-6
- (5) Нормы токсичности отработавших газов: Евро-3 / Euro 4
- (6) Нормы токсичности отработавших газов: Евро-4 / Euro 5
- (7) Нормы токсичности отработавших газов: Евро-5 / Euro 6
- (8) Количество накладок
- (9) Вилка выключения сцепления висящая [мм]
- (10) Вилка выключения сцепления стоящая [мм]
- (11) Наружный диаметр [мм]
- (12) Сменяемая деталь заменена на 3400 121 002
- (13) В случае возникновения шумов
- (14) Включает выжимной подшипник и монтажный комплект
- (15) Включает ДМ, нажимной, ведомый диски сцепления и выжимной подшипник
- (16) Включает ДМ, нажимной, ведомый диски сцепления и CSC
- (17) Бензин
- (18) Ширина [мм]
- (19) Дизель
- (20) На автомобиле может быть установлено сцепление разного размера
- (21) Автомобили могут быть оснащены различными компонентами
- (22) Коробка передач Fuller
- (23) Рабочая среда: тормозная жидкость
- (24) Рабочая среда: минеральное масло
- (25) Для экспорта
- (26) Номер коробки передач
- (27) Длина кожуха [мм]
- (28) Всегда заменять
- (29) Содержится в 1888
- (30) Содержится в 3483/3488
- (31) Содержится в 3488.
- (32) Внутренний диаметр [мм]
- (33) С разным сцеплением по желанию заказчика
- (34) Длина кабеля [мм]
- (35) Характеристика
- (36) Шарикоподшипник
- (37) Ведомый диск сцепления с первичным гасителем
- (38) Мощность [кВт]
- (39) Незакрепленный ведомый диск сцепления
- (40) Экспортное исполнение: Великобритания
- (41) Экспортное исполнение: Турция
- (42) Длина [мм]
- (43) Вид монтажа: без предварительной сборки
- (44) Монтажный комплект для выжимного подшипника
- (45) Конструкция двигателя
- (46) Профиль ступицы
- (47) Игольчатый подшипник
- (48) Идентификатор механизма отбора мощности
- (49) Поставляется только при возврате старой детали (ремонт; завод в Bielefeld)

Переводы

(50) Устанавливать только в том случае, если автомобиль оснащен сцеплением M

(51) Устанавливать только совместно

(52) Производственный номер

(53) Колесная база [мм]

(54) Секвентальная коробка передач

(55) Механическая коробка передач с автоматическим управлением

(56) Специальное исполнение

(57) Жесткий ведомый диск сцепления

(58) Ведомый диск сцепления с торсионным демпфером

(59) Коробка передач ZF

(60) Начиная с производственного номера

(61) Альтернативный ремкомплект

(63) До производственного номера

(64) включает винты крепления нажимного диска

(65) Включает в себя винты крепления нажимного диска

(66) Включает один диск сцепления

(67) Включает два диска сцепления

(68) Для

(69) Для вилки выключения сцепления с кулачками

(70) Для вилки выключения сцепления с роликами

(71) Для автомобилей с однодисковым сцеплением

(72) Для автомобилей с усилителем привода управления сцеплением

(73) Для автомобилей с механизмом отбора мощности

(74) Для автомобилей с тормозной системой низкого давления

(75) Для автомобилей с ретардером

(76) Для автомобилей с блокировочной муфтой трансформатора

(77) Для автомобилей с двухдисковым сцеплением

(78) Для диафрагменных пружин с внутренним диаметром 100 мм

(79) Для диафрагменных пружин с внутренним диаметром 120 мм

(80) Для двигателей с двухмассовым маховиком

(81) Для двигателей без двухмассового маховика

(82) Для механизма отбора мощности

(83) Для оригинального номера детали

(84) Для глубины маховика [мм]

(85) В зависимости от исполнения с различным сцеплением

(86) Длинный зажим

(87) Макс. передаваемый крутящий момент двигателя [Нм]

(88) С упорным кольцом

(89) С постоянной смазкой

(90) С ретардером VR 115E

(91) С подключением трубопровода для смазочной линии

(92) С датчиком

(93) С зубчатым венцом

(94) С принадлежностями

(95) С прокладочным кольцом

(96) Не для

(97) Не для шасси номера

(98) Не для номера двигателя

(99) Не в сочетании с обратным ведомым диском сцепления

Переводы

(100) Только в качестве замены для указанного оригинального №

(101) Только в комбинации с

(102) Без упорного кольца

(103) Без подключения трубопровода для смазочной линии

(104) Без датчика

(105) Без прокладочного кольца

DE

EN

FR

ES

PT

IT

NL

NO

SV

FI

PL

RU

HU

CS

RO

HR

EL

TR

ZH

DE

EN

FR

ES

PT

IT

NL

NO

SV

FI

PL

RU

HU

CS

RO

HR

EL

TR

ZH

Memo

Általános információk



A jelen katalógusban feltüntetett valamennyi terméket csak gépjármű-javító szakműhely szakképzett személyzete építheti be.

A rendelésekhez szükségünk van a teljes alvázsámra, például:

Tengelykapcsoló-készlet	3400 122 201
Tengelykapcsoló nyomólap	3482 083 032
Kuplungtárcsa	1878 004 832
Kinyomócsapágó	3151 000 034

Kétely esetén adja meg a cikkhez illő jármű típus-megnevezését és gyártási évét.

Minden jog fenntartva. Tilos a tulajdonos kifejezett engedély nélkül a katalógus sokszorosítása vagy közös használata, akár kivonatolva is, saját katalógus készítése céljából.

A járműgyártók pótalkatrész-számai csak az összehasonlítást szolgálják. Ezen adatok használata a jármű tulajdonosának kiállított számlában nem megengedett.

Az aktuális általános üzleti feltételeket a következő címen találja meg www.zf.com/services/documents

www.zf.com/services/catalog

WebCat

Online katalógus

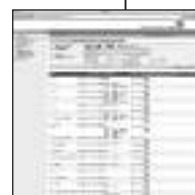

InCat

Elektronikus katalógus



PrintCat

Nyomtatott katalógusok



Tartalomjegyzék

Index	U2
Szimbólumok	U5 - U6
Általános információk	V67
A katalógus felépítése	V68
Jellemzők	V68
Fordítások	V69 - V71
Aritmetikai lista	842 - 884
Összehasonlító lista	884 - 926
Új tételek	927 - 928
Módosított megrendelési szám	929
Törölt számok	930
Mérettáblázat bordázathoz	931
Mérettáblázat lendkerekekhez	932 - 933

A katalógus felépítése

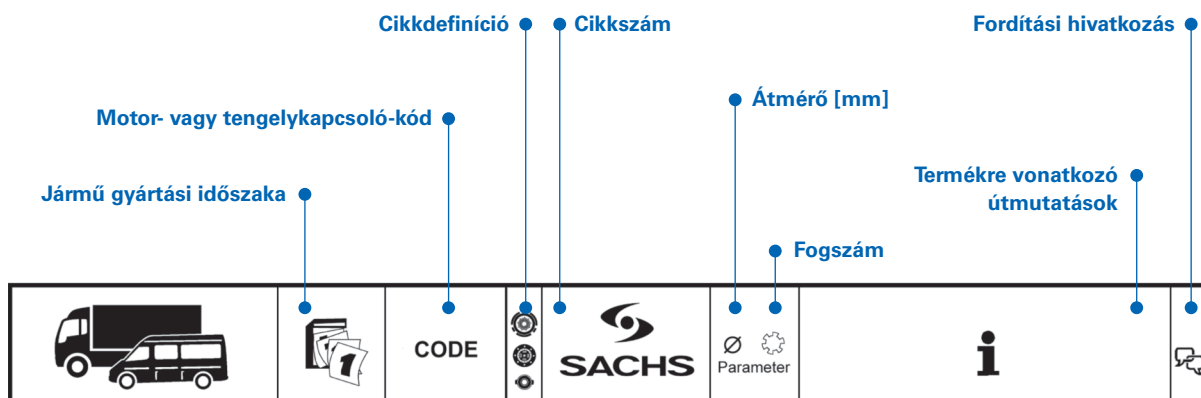

DAF

LF		10.13 -				
LF 180		PX-5135	3400 700 465 3482 000 859 1878 005 601 3151 000 651	362 10 MF362 362WGTZ KZIS-4	Getr. / GBox: 6 S 700 Getr. / GBox: 6 AS 700 Abgasnorm: Euro 6 / Exhaust Emission Norm: Euro 6	(4)
			3400 700 464 3482 000 859 1878 005 600 3151 000 651	362 10 MF362 362WGTZ KZIS-4	Getr. / GBox: 6 S 800 Getr. / GBox: 6 AS 800 Abgasnorm: Euro 6 / Exhaust Emission Norm: Euro 6	(4)
			3400 700 603 3482 001 166 1878 007 172 3151 000 397	350 MF350 350WGTZ KZIS-4	Getr. / GBox: S5-42 Abgasnorm: Euro 6 / Exhaust Emission Norm: Euro 6	(4)
LF 210		PX-5157	3400 700 465 3482 000 859 1878 005 601 3151 000 651	362 10 MF362 362WGTZ KZIS-4	Getr. / GBox: 6 S 700 Getr. / GBox: 6 AS 700 Abgasnorm: Euro 6 / Exhaust Emission Norm: Euro 6	(4)
			3400 700 464 3482 000 859 1878 005 600 3151 000 651	362 10 MF362 362WGTZ KZIS-4	Getr. / GBox: 6 S 800 Getr. / GBox: 6 AS 800 Abgasnorm: Euro 6 / Exhaust Emission Norm: Euro 6	(4)
			3400 700 603 3482 001 166 1878 007 172 3151 000 397	350 MF350 350WGTZ KZIS-4	Getr. / GBox: S5-42 Abgasnorm: Euro 6 / Exhaust Emission Norm: Euro 6	(4)

Jellemzők

Kuplung nyomólapok

Z/	Kéttárcsás kivitelhez
400	Dörzsfelület külső átmérője 400 mm
Do	Dupla kuplung, függő kinyomás
Du	Dupla kuplung, független kinyomás
/E	XTend
F	Lapos lendkerék
G	Kuplung öntvényházzal
K	Spirálrugós kuplung
KM	Membránrugóval és emelőrendszerrel
M	Tányérrugós kuplung
N	Mellékajtás
S	Önbeálló csatlakozásos kivitel
T	Tányérrugóval
XTend	Automatikus utánállítással
Z	Kinyomás húzásra

Kuplungtárcsák

200	Külső átmérő 200 mm
CE	Szeretlen fémbevonat
B/D/E/Z	Burkolatrugózások
BH/GS/GT/GV	Torziós csillapító haszongépjárművekhez
/E	XTend
W/V	Előlenegcsillapító haszongépjárművekhez

Kinyomócsapágy

...A	Együtt mozgó külső gyűrű
G	Grafit indítógyűrű
GK	Grafit indítógyűrű és golyóscsapágy
GR	Golyóscsapágy lemezkupakkal
GZ	Elsődleges kuplunghenger
HHIS	Koncentrikus másodlagos kuplung henger
...I	Együtt mozgó belső gyűrű
KT	Teflon indítótarcsa
KZ	Golyóscsapágy, központi vezetésű
NZ	Másodlagos kuplunghenger
...S	Öncentrírozó belső gyűrű
...Z	Kinyomás húzásra

Fordítások

(1)	Kibocsátási norma: Euro 3
(2)	Kibocsátási norma: Euro 4 (D4)
(3)	Kibocsátási norma: Euro 5
(4)	Kibocsátási norma: Euro 6
(5)	Kibocsátási norma: Euro 3 / Euro 4
(6)	Kibocsátási norma: Euro 4 / Euro 5
(7)	Kibocsátási norma: Euro 5 / Euro 6
(8)	Betétek száma
(9)	Függő kinyomó villa [mm]
(10)	Álló kinyomó villa [mm]
(11)	Külső átmérő [mm]
(12)	A cserealkatrészt a 3400 121 002 váltja fel
(13)	Zajproblémáknál
(14)	Kinyomócsapágyat és szerelőkészletet tartalmaz
(15)	Kéttömegű lendkereket, nyomólapot, kuplungtárcsát és kinyomócsapágyat tartalmaz
(16)	Kéttömegű lendkereket, nyomólapot, kuplungtárcsát és CSC-t tartalmaz
(17)	Benzin
(18)	Szélesség [mm]
(19)	Dízel
(20)	A jármű eltérő kuplungmérettel is rendelkezik
(21)	A járművek különböző alkatrészekkel lehetnek felszerelve
(22)	Fuller váltó
(23)	Töltőközeg: Fékfolyadék
(24)	Töltőközeg: Ásványolaj
(25)	Exportra
(26)	Váltó száma
(27)	Palásthossz [mm]
(28)	Mindig cserélendő
(29)	A 1888 tartalmazza
(30)	A 3483/3488 tartalmazza
(31)	A 3488... .. tartalmazza
(32)	Belső átmérő [mm]
(33)	Vevő kérésére különböző kuplunggal
(34)	Kábelhossz [mm]
(35)	Jellemző érték
(36)	Golyócsapágy
(37)	Kuplungtárcsa előcsillapítóval
(38)	Teljesítmény [kW]
(39)	Szabad kuplungtárcsa
(40)	Országgra jellemző kivitel: Nagy-Britannia
(41)	Országgra jellemző kivitel: Törökország
(42)	Hosszúság [mm]
(43)	Szerelési mód: Nem előreszerelt
(44)	Szerelőkészlet a kinyomócsapágyhoz
(45)	Motortípus
(46)	Bordázat
(47)	Tűcsapágy
(48)	Mellékhatás-ID
(49)	Csak régi alkatrész visszaszolgáltatása esetén szállítható (javítás; Bielefeld üzem)

Fordítások

(50) Csak akkor építhető be, ha a jármű M-kuplunggal van ellátva

(51) Csak együtt lehet beépíteni

(52) Gyártási szám

(53) Tengelytáv [mm]

(54) Szekvenciális váltó

(55) Sebességváltó, automatikus működtetés

(56) Különleges kivitel

(57) Merev kuplungtárcsa

(58) Torziósrugózású kuplungtárcsa

(59) ZF váltó

(60) Gyártási számtól

(61) Alternatív javítókészlet

(63) Gyártási számig

(64) Nyomólap-rögzítőcsavarokat tartalmaz

(65) Lendkerék-rögzítőcsavarokat tartalmaz

(66) Egy kuplungtárcsát tartalmaz

(67) Két kuplungtárcsát tartalmaz

(68) Ehhez

(69) Büttykös kinyomóvillához

(70) Görgős kinyomóvillához

(71) Egytárcsás kuplunggal szerelt járművekhez

(72) Kuplungerősítővel szerelt járművekhez

(73) Mellékhajtással rendelkező járművekhez

(74) Alacsony nyomású fékrendszerrel szerelt járművekhez

(75) Retarderrel szerelt járművekhez

(76) Nyomatékmódosító kuplunggal szerelt járművekhez

(77) Kéttárcsás kuplunggal szerelt járművekhez

(78) 100 mm belső átmérőjű membránrugóhoz

(79) 120 mm belső átmérőjű membránrugóhoz

(80) Kétsúlyos lendkerékkel rendelkező motorokhoz

(81) Kétsúlyos lendkerék nélküli motorokhoz

(82) Mellékhajtáshoz

(83) OE számhoz

(84) Lendkerék-mélységhez [mm]

(85) Kivitel szerint különböző kuplunggal

(86) Hosszú kengyel

(87) Max. átvihető motornyomaték [Nm]

(88) Indítógyűrűvel

(89) Tartós kenéssel

(90) VR 115E retarderrel

(91) Kenőcső csatlakozóval

(92) Érzékelővel

(93) Fogaskoszorúval

(94) Tartozékokkal

(95) Közbenső gyűrűvel

(96) Ezekhez nem

(97) Nem a következő alvázszámhoz

(98) Ehhez a motorszámhoz nem

(99) Nem csere-kuplungtárcsával együtt

Fordítások

(100) Csak csereként a megadott OE-számhoz

(101) Csak ezzel kapcsolatban

(102) Indítógyűrű nélkül

(103) Kenőcsőcsatlakozó nélkül

(104) Érzékelő nélkül

(105) Közbenső gyűrű nélkül

DE

EN

FR

ES

PT

IT

NL

NO

SV

FI

PL

RU

HU

CS

RO

HR

EL

TR

ZH

DE

EN

FR

ES

PT

IT

NL

NO

SV

FI

PL

RU

HU

CS

RO

HR

EL

TR

ZH

Memo

Všeobecné informace



Všechny výrobky uvedené v tomto katalogu smí instalovat pouze školený personál odborného autoservisu.

Pro vaše požadavky potřebujeme úplné objednávací číslo, např.:

Spojková sada	3400 122 201
Přítlačná deska spojky	3482 083 032
Kotouč spojky	1878 004 832
Vypínací ústrojí	3151 000 034

V případě pochybností udejte typové označení a rok výroby vozidla, pro které je požadovaný výrobek určen.

Všechna práva vyhrazena. Rozmnožování nebo využití tohoto katalogu nebo jeho částí pro výrobu vlastního katalogu nejsou bez výslovného souhlasu dovoleny.

Číslo náhradních dílů výrobců vozidel slouží jen pro účely srovnávání. Použití takových údajů ve fakturách vlastníků vozidel není dovoleno.

Aktuální obecné obchodní podmínky najdete na www.zf.com/services/documents

www.zf.com/services/catalog

WebCat

Katalog online



InCat

Elektronický katalog



PrintCat

Tištěné katalogy



Obsah

Index	U2
Symboly	U5 - U6
Všeobecné informace	V73
Struktura katalogu	V74
Parametry	V74
Překlady	V75 - V77
Aritmetický soupis	842 - 884
Srovnávací seznam	884 - 926
Nové výrobky	927 - 928
Změněné objednávací číslo	929
Výřazená čísla	930
Tabulka rozměrů profilů nábojů	931
Tabulka rozměrů setrvačnickových kol	932 - 933

Struktura katalogu

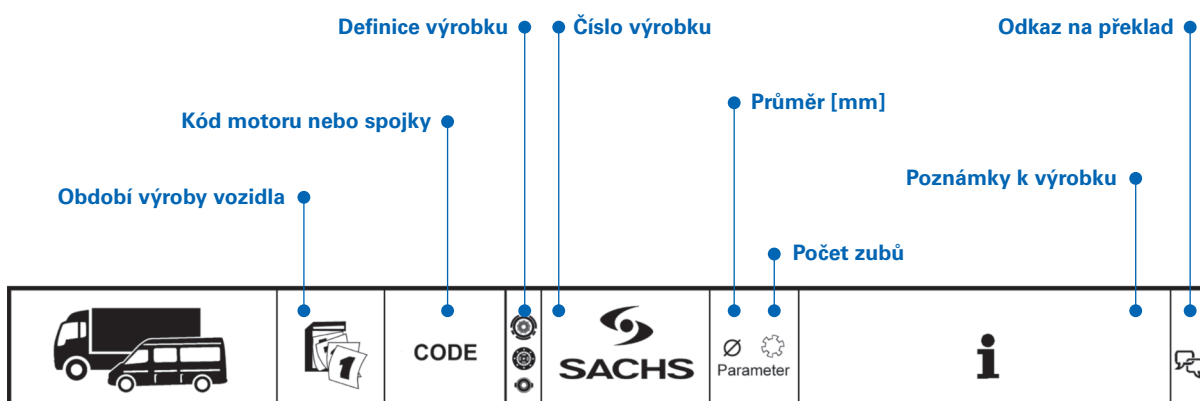

DAF

LF		10.13 -				
LF 180		PX-5135	3400 700 465 3482 000 859 1878 005 601 3151 000 651	362 10 MF362 362WGTZ KZIS-4	Getr. / GBox: 6 S 700 Getr. / GBox: 6 AS 700 Abgasnorm: Euro 6 / Exhaust Emission Norm: Euro 6	(4)
			3400 700 464 3482 000 859 1878 005 600 3151 000 651	362 10 MF362 362WGTZ KZIS-4	Getr. / GBox: 6 S 800 Getr. / GBox: 6 AS 800 Abgasnorm: Euro 6 / Exhaust Emission Norm: Euro 6	(4)
			3400 700 603 3482 001 166 1878 007 172 3151 000 397	350 MF350 350WGTZ KZIS-4	Getr. / GBox: S5-42 Abgasnorm: Euro 6 / Exhaust Emission Norm: Euro 6	(4)
LF 210		PX-5157	3400 700 465 3482 000 859 1878 005 601 3151 000 651	362 10 MF362 362WGTZ KZIS-4	Getr. / GBox: 6 S 700 Getr. / GBox: 6 AS 700 Abgasnorm: Euro 6 / Exhaust Emission Norm: Euro 6	(4)
			3400 700 464 3482 000 859 1878 005 600 3151 000 651	362 10 MF362 362WGTZ KZIS-4	Getr. / GBox: 6 S 800 Getr. / GBox: 6 AS 800 Abgasnorm: Euro 6 / Exhaust Emission Norm: Euro 6	(4)
			3400 700 603 3482 001 166 1878 007 172 3151 000 397	350 MF350 350WGTZ KZIS-4	Getr. / GBox: S5-42 Abgasnorm: Euro 6 / Exhaust Emission Norm: Euro 6	(4)

Parametry

Přítlačné desky spojky

Z/	Pro dvoukotoučové provedení
400	Vnější průměr třecích ploch 400 mm
Do	Dvojitá spojka, závislé rozpojení
Du	Dvojitá spojka, nezávislé rozpojení
/E	XTend
F	Plochý setrvačník
G	Spojka s litým tělem
K	Šroubová pružinová spojka
KM	S membránovou pružinou a pákovým systémem
M	Membránová pružná spojka
N	Pomocný pohon
S	Provedení kyvného čepu
T	S talířovou pružinou
XTend	S automatickým nastavením
Z	Rozpojení tahem

Spojkové kotouče

200	Vnější průměr 200 mm
CE	Anorganické sintrované obložení
B/D/E/Z	Odpružení obložení
BH/GS/GT/GV	Torzní tlumiče pro užitková vozidla
/E	XTend
W/V	Vstupní potrubí tlumiče pro užitková vozidla

Výsuvná ložiska

...A	Vnější kroužek otáčivý
G	Grafitový přítlačný kroužek
GK	Grafitový přítlačný kroužek a kuličkové ložisko
GR	Kuličkové ložisko s plechovým víčkem
GZ	Hlavní válec
HHIS	Koncentrický pracovní válec
...I	Vnitřní kroužek otáčivý
KT	Teflonová opěrná podložka
KZ	Kuličkové ložisko, s centrálním vedením
NZ	Pracovní válec
...S	Samostředící vnitřní kroužek
...Z	Rozpojení tahem

Překlady

(1)	Emisní norma: Euro 3
(2)	Emisní norma: Euro 4 (D4)
(3)	Emisní norma: Euro 5
(4)	Emisní norma: Euro 6
(5)	Emisní norma: Euro 3 / Euro 4
(6)	Emisní norma: Euro 4 / Euro 5
(7)	Emisní norma: Euro 5 / Euro 6
(8)	Počet obložení
(9)	Vysouvací vidlice zavěšená [mm]
(10)	Vysouvací vidlice stojatá [mm]
(11)	Vnější průměr [mm]
(12)	Výměnná součást nahrazená 3400 121 002
(13)	Při problémech s hlukem
(14)	Obsahuje vypínací ústrojí a montážní sadu
(15)	Obsahuje DHS, přitlačný kotouč, spojkovou lamelu a vypínací ústrojí
(16)	Obsahuje DHS, přitlačný kotouč, spojkovou lamelu a CSC
(17)	Benzín
(18)	Šířka [mm]
(19)	Diesel
(20)	Vozidlo může být vybaveno různými velikostmi spojky
(21)	Vozidla mohou být vybavena různými komponentami
(22)	Převodovky Fuller
(23)	Plnicí médium: Brzdová kapalina
(24)	Plnicí médium: Minerální olej
(25)	Pro export
(26)	Číslo převodovky
(27)	Délka obálky [mm]
(28)	Vždy vyměňte
(29)	V 1888 je obsaženo
(30)	V 3483/3488 je obsaženo
(31)	V 3488 je obsaženo
(32)	Vnitřní průměr [mm]
(33)	Podle přání zákazníka osazení různými spojkami
(34)	Délka kabelu [mm]
(35)	Parametr
(36)	Kuličkové ložisko
(37)	Spojková lamela s předřazeným tlumičem
(38)	Výkon [kW]
(39)	Volný kotouč spojky
(40)	Provedení pro zemi: Velká Británie
(41)	Provedení pro zemi: Turecko
(42)	Délka [mm]
(43)	Druh montáže: Není předmontován
(44)	Montážní sada pro výsuvné ložisko
(45)	Konstrukce motoru
(46)	Profil náboje
(47)	Jehlové ložisko
(48)	ID pomocného pohonu
(49)	Lze dodat jen při vrácení starého dílu (oprava; závod Bielefeld)

Překlady

- (50) Montujte pouze když je vozidlo vybaveno spojkou M
- (51) Montujte pouze společně
- (52) Číslo výroby
- (53) Rozvor kol [mm]
- (54) Sekvenční manuální převodovka
- (55) Automatizovaná ruční převodovka
- (56) Speciální provedení
- (57) Tuhý kotouč spojky
- (58) Torzně odpružený kotouč spojky
- (59) Přebodovky ZF
- (60) Od čísla výrobku
- (61) Alternativní sada pro opravy
- (63) Do čísla výroby
- (64) Obsahuje upevňovací šrouby přítlačné desky
- (65) Obsahuje upevňovací šrouby setrvačnicku
- (66) Obsahuje jeden kotouč spojky
- (67) Obsahuje dva kotouče spojky
- (68) Pro
- (69) Pro vysouvací vidlici s výstupky
- (70) Pro vysouvací vidlici s válečky
- (71) Pro vozidla s jednokotoučovou spojkou
- (72) Pro vozidla s spojkou s posilovačem
- (73) Pro vozidla s vedlejším pohonem
- (74) Pro vozidla s nízkotlakým brzdovým systémem
- (75) Pro vozidla s retardérem
- (76) Pro vozidla s řadicí spojkou měniče točivého momentu
- (77) Pro vozidla s dvoukotoučovou spojkou
- (78) Pro membránové pružiny s vnitřním průměrem 100 mm
- (79) Pro membránové pružiny s vnitřním průměrem 120 mm
- (80) Pro motory s dvouhmotovým setrvačnickem
- (81) Pro motory bez dvouhmotového setrvačnicku
- (82) Pro pomocný pohon
- (83) Pro číslo dílu O
- (84) Pro hloubku setrvačnicku [mm]
- (85) Podle provedení s různými spojkami
- (86) Dlouhý třmen
- (87) Max. přenášený moment motoru [Nm]
- (88) S přítlačným kroužkem
- (89) S trvalým mazáním
- (90) S retardérem VR 115E
- (91) S přípojkou mazací trubky
- (92) S snímačem
- (93) S ozubeným věncem
- (94) S příslušenstvím
- (95) S vloženým kroužkem
- (96) Ne pro
- (97) Ne pro číslo podvozku
- (98) Ne pro číslo motoru
- (99) Ne ve spojení s výměnným kotoučem spojky

Překlady

(100) Jen jako náhrada za uvedené č. OE

(101) Jen ve spojení s

(102) Bez přitlačného kroužku

(103) Bez přípojky mazací trubky

(104) Bez snímače

(105) Bez vloženého kroužku

DE

EN

FR

ES

PT

IT

NL

NO

SV

FI

PL

RU

HU

CS

RO

HR

EL

TR

ZH

DE

EN

FR

ES

PT

IT

NL

NO

SV

FI

PL

RU

HU

CS

RO

HR

EL

TR

ZH

Memo

Informații generale



Montarea tuturor produselor prezentate în acest catalog este permisă numai personalului instruit al unui atelier de specialitate auto.

Pentru solicitarea dvs. avem nevoie de numărul complet al comenzii, de exemplu:

Kit ambreiaj	3400 122 201
Placă de presiune la ambreiaj	3482 083 032
Disc de ambreiaj	1878 004 832
Dispozitiv de debreiere	3151 000 034

În caz de dubii indicați denumire tipului și anul fabricației vehiculului aferent articolului dorit.

Toate drepturile rezervate. Sunt interzise multiplicarea sau utilizarea comună a catalogului, chiar și în extras, pentru elaborarea unui catalog propriu, dacă se fac fără o aprobare expres în acest sens.

Numărul pieselor de schimb ale producătorului autovehiculului servesc numai pentru comparare. Nu este admisă folosirea unor astfel de date în facturile emise proprietarului vehiculului.

Condițiile comerciale actuale veți găsi la www.zf.com/services/documents

www.zf.com/services/catalog

WebCat
Catalog online

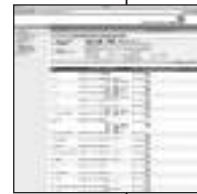

InCat
Catalog electronic



PrintCat
Cataloage tipărite



Cuprins

Index	U2
Simboluri	U5 - U6
Informații generale	V79
Structura catalogului	V80
Caracteristici	V80
Traduceri	V81 - V83
Listă aritmetică	842 - 884
Listă de comparație	884 - 926
Înregistrări noi	927 - 928
Număr de comandă modificat	929
Număr barat	930
Tabel de cote pentru profile de butuc	931
Tabel de cote pentru volante	932 - 933

Structura catalogului

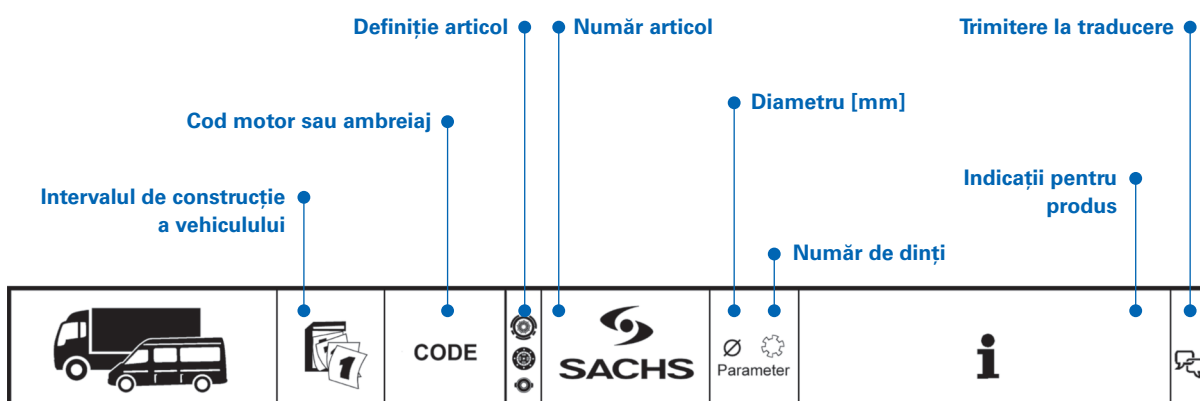

DAF

LF		10.13 -				
LF 180		PX-5135	3400 700 465 3482 000 859 1878 005 601 3151 000 651	362 10 MF362 362WGTZ KZIS-4	Getr. / GBox: 6 S 700 Getr. / GBox: 6 AS 700 Abgasnorm: Euro 6 / Exhaust Emission Norm: Euro 6	(4)
			3400 700 464 3482 000 859 1878 005 600 3151 000 651	362 10 MF362 362WGTZ KZIS-4	Getr. / GBox: 6 S 800 Getr. / GBox: 6 AS 800 Abgasnorm: Euro 6 / Exhaust Emission Norm: Euro 6	(4)
			3400 700 603 3482 001 166 1878 007 172 3151 000 397	350 MF350 350WGTZ KZIS-4	Getr. / GBox: S5-42 Abgasnorm: Euro 6 / Exhaust Emission Norm: Euro 6	(4)
LF 210		PX-5157	3400 700 465 3482 000 859 1878 005 601 3151 000 651	362 10 MF362 362WGTZ KZIS-4	Getr. / GBox: 6 S 700 Getr. / GBox: 6 AS 700 Abgasnorm: Euro 6 / Exhaust Emission Norm: Euro 6	(4)
			3400 700 464 3482 000 859 1878 005 600 3151 000 651	362 10 MF362 362WGTZ KZIS-4	Getr. / GBox: 6 S 800 Getr. / GBox: 6 AS 800 Abgasnorm: Euro 6 / Exhaust Emission Norm: Euro 6	(4)
			3400 700 603 3482 001 166 1878 007 172 3151 000 397	350 MF350 350WGTZ KZIS-4	Getr. / GBox: S5-42 Abgasnorm: Euro 6 / Exhaust Emission Norm: Euro 6	(4)

Caracteristici

Plăci de presiune la ambreiaj

Z/	Pentru execuția cu volanță dublă
400	Diametru exterior al suprafeței de fricțiune 400 mm
Do	Ambreiaj dublu, dispozitiv de debreiere dependent
Du	Ambreiaj dublu, dispozitiv de debreiere independent
/E	XTend
F	Volanță plată
G	Ambreiaj cu carcasă turnată
K	Ambreiaj cu arc elicoidal
KM	Cu arc cu membrană și sistem de pârghii
M	Ambreiaj cu arc cu membrană
N	Priză de putere
S	Variantă cu bolț pivotant
T	Cu arc cu rondelă
XTend	Cu reajustare automată
Z	Dispozitiv de debreiere pe cablu

Discuri de ambreiaj

200	Diametru exterior 200 mm
CE	Garnitură sinterizată anorganică
B/D/E/Z	Suspensii cu garnitură
BH/GS/GT/GV	Amortizor de torsiune pentru autoutilitare
/E	XTend
W/V	Preamortizor pentru autoutilitare

Rulment de debreiere

...A	Inel exterior antrenat sincron
G	Inel de atac cu grafit
GK	Inel de atac cu grafit și rulment cu bile
GR	Rulment cu bile și cu căpăcel din tablă
GZ	Pompă de ambreiaj
HHIS	Cilindru receptor de ambreiaj, concentric
...I	Inel interior antrenat sincron
KT	Disc de atac cu teflon
KZ	Rulment cu bile, central
NZ	Cilindru receptor de ambreiaj
...S	Rulment interior autocentrant
...Z	Dispozitiv de debreiere pe cablu

Traduceri

- (1) Emisii standard de noxe: Euro 3
- (2) Emisii standard de noxe: Euro 4 (D4)
- (3) Emisii standard de noxe: Euro 5
- (4) Emisii standard de noxe: Euro 6
- (5) Emisii standard de noxe: Euro 3 / Euro 4
- (6) Emisii standard de noxe: Euro 4 / Euro 5
- (7) Emisii standard de noxe: Euro 5 / Euro 6
- (8) Numărul de garnituri
- (9) Furcă de debreiere, suspendată [mm]
- (10) Furcă de debreiere, verticală [mm]
- (11) Diametrul exterior [mm]
- (12) Piesă de schimb recondiționată înlocuită cu 3400 121 002
- (13) În caz de zgomote
- (14) Conține dispozitiv de debreiere și set montaj
- (15) Conține volanta cu masă dublă, placa de presiune ambreiaj, discul de ambreiaj și dispozitivul de debreiere
- (16) Conține volanta cu masă dublă, placa de presiune ambreiaj, discul de ambreiaj și CSC
- (17) Benzină
- (18) Lățime [mm]
- (19) Diesel
- (20) Vehiculul poate fi echipat cu ambreiaje de mărimi diferite
- (21) Vehiculele pot fi dotate cu componente diferite
- (22) Transmisie Fuller
- (23) Mediu de alimentare: Lichid de frână
- (24) Mediu de alimentare: Ulei mineral
- (25) Pentru export
- (26) Număr transmisie
- (27) Lungime manșon [mm]
- (28) Se va înnoi de fiecare dată
- (29) Conținut în 1888
- (30) Conținut în 3483/3488
- (31) Conținut în 3488
- (32) Diametru interior [mm]
- (33) Echipat cu ambreiaje diferite, în funcție de cerințele clientului
- (34) Lungime cablu [mm]
- (35) Caracteristică
- (36) Rulment cu bile
- (37) Disc ambreiaj cu preamortizor
- (38) Putere [kW]
- (39) Disc de ambreiaj desprins
- (40) Varianta de țară: Marea Britanie
- (41) Varianta de țară: Turcia
- (42) Lungime [mm]
- (43) Tipul montării: Fără premontare
- (44) Set de montaj pentru rulment de ambreiaj
- (45) Model motor
- (46) Profil butuc roată
- (47) Rulment cu ace
- (48) ID priză de putere

DE

EN

FR

ES

PT

IT

NL

NO

SV

FI

PL

RU

HU

CS

RO

HR

EL

TR

ZH

Traduceri

(49) Disponibil numai cu predarea piesei uzate (reparație, uzina Bielefeld)

(50) Montați numai dacă vehiculul este echipat cu ambreiaj de tip M

(51) Nu se montează decât împreună

(52) Număr de producție

(53) Ampatament [mm]

(54) Cutie de viteze manuală secvențială

(55) Cutie de viteze manuală, automatizată

(56) Construcție specială

(57) Disc de ambreiaj rigid

(58) Disc de ambreiaj rezistent la torsiune

(59) Transmisie ZF

(60) De la numărul de producție

(61) Set reparație alternativ

(63) Până la numărul de producție

(64) Conține șuruburi de fixare pentru placa de presiune

(65) Conține șuruburi de fixare pentru volantă

(66) Conține un disc de ambreiaj

(67) Conține două discuri de ambreiaj

(68) Pentru

(69) Pentru furca de debreiere cu came

(70) Pentru furca de debreiere cu role

(71) Pentru vehicule având ambreiaj cu un disc

(72) Pentru vehicule cu servo-ambreiaj

(73) Pentru vehicule cu priză auxiliară de putere

(74) Pentru vehicule cu instalație de frână de joasă presiune

(75) Pentru vehicule cu Retarder

(76) Pentru vehicule având ambreiaj cu convertor de cuplu

(77) Pentru vehicule având ambreiaj cu două discuri

(78) Pentru arc membrană cu diametru interior de 100 mm

(79) Pentru arc membrană cu diametru interior de 120 mm

(80) Pentru motoare cu volantă cu masă dublă

(81) Pentru motoare fără volantă cu masă dublă

(82) Pentru priză de putere

(83) Pentru număr OE

(84) Pentru grosimea volantei [mm]

(85) Echipat cu ambreiaje diferite în funcție de variantă

(86) Cadru lung

(87) Cuplul motor max. transmisibil [Nm]

(88) Cu inel de atac

(89) Cu lubrifiere permanentă

(90) Cu Retarder VR 115E

(91) Cu racord pentru tub de lubrifiere

(92) Cu senzor

(93) Cu coroană dințată

(94) Cu accesorii

(95) Cu inel intermediar

(96) Nu pentru

(97) Nu pentru număr șasiu

(98) Nu pentru serie motor

Traduceri

(99) Nu în combinație cu disc de ambreiaj de schimb

(100) Numai ca înlocuitor pentru nr. OE indicate

(101) Numai în combinație cu

(102) Fără inel de atac

(103) Fără racord pentru tub de lubrifiere

(104) Fără senzor

(105) Fără inel intermediar

DE

EN

FR

ES

PT

IT

NL

NO

SV

FI

PL

RU

HU

CS

RO

HR

EL

TR

ZH

DE

EN

FR

ES

PT

IT

NL

NO

SV

FI

PL

RU

HU

CS

RO

HR

EL

TR

ZH

Memo

Opće informacije



Sve proizvode navedene u ovom katalogu smiju ugrađivati samo školovani mehaničari u servisnoj radionici za motorna vozila.

Za vaše zahtjeve potreban nam je potpuni broj narudžbe, primjerice:

Komplet spojki	3400 122 201
Kompresijska ploča spojke	3482 083 032
Disk spojke	1878 004 832
Isključivač	3151 000 034

Ako ste u nedoumici, navedite oznaku tipa i godinu proizvodnje vozila za koje je namijenjen željeni artikl.

Sva prava pridržana. Umnožavanje ili dijeljenje ovog kataloga, djelomično ili u cijelosti, radi izrade vlastita kataloga zabranjeno je bez izričitog pristanka njegova vlasnika.

Brojevi rezervnih dijelova proizvođača vozila služe samo za usporedbu. Primjena takvih podataka u računima izdanim vlasnicima vozila nije dopuštena.

Aktualne opće uvjete poslovanja naći ćete na adresi www.zf.com/services/documents

www.zf.com/services/catalog

WebCat
Online katalog

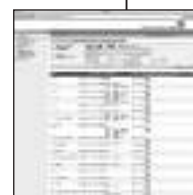

InCat
Elektronički katalog



PrintCat
Tiskani katalogi



Kazalo

Index	U2
Simboli	U5 - U6
Opće informacije	V85
Struktura kataloga	V86
Karakteristične veličine	V86
Prijevodni	V87 - V89
Aritmetička lista	842 - 884
Usporedni popis	884 - 926
Novi unosi	927 - 928
Izmijenjeni broj narudžbe	929
Precrtani brojevi	930
Mjerna tablica za profil glavčine	931
Mjerna tablica za zamašne ploče	932 - 933

Struktura kataloga

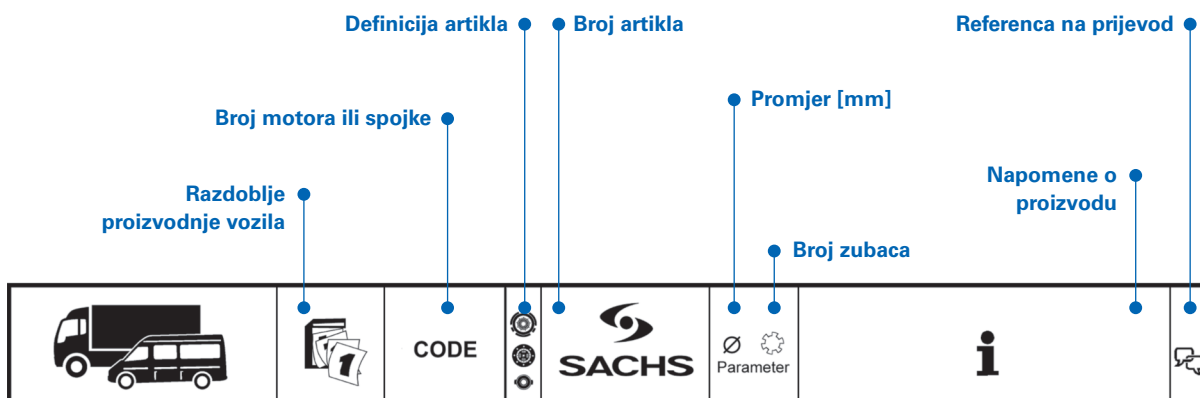

DAF

LF		10.13 -				
LF 180		PX-5135	3400 700 465 3482 000 859 1878 005 601 3151 000 651	362 10 MF362 362WGTZ KZIS-4	Getr. / GBox: 6 S 700 Getr. / GBox: 6 AS 700 Abgasnorm: Euro 6 / Exhaust Emission Norm: Euro 6	(4)
			3400 700 464 3482 000 859 1878 005 600 3151 000 651	362 10 MF362 362WGTZ KZIS-4	Getr. / GBox: 6 S 800 Getr. / GBox: 6 AS 800 Abgasnorm: Euro 6 / Exhaust Emission Norm: Euro 6	(4)
			3400 700 603 3482 001 166 1878 007 172 3151 000 397	350 MF350 350WGTZ KZIS-4	Getr. / GBox: S5-42 Abgasnorm: Euro 6 / Exhaust Emission Norm: Euro 6	(4)
LF 210		PX-5157	3400 700 465 3482 000 859 1878 005 601 3151 000 651	362 10 MF362 362WGTZ KZIS-4	Getr. / GBox: 6 S 700 Getr. / GBox: 6 AS 700 Abgasnorm: Euro 6 / Exhaust Emission Norm: Euro 6	(4)
			3400 700 464 3482 000 859 1878 005 600 3151 000 651	362 10 MF362 362WGTZ KZIS-4	Getr. / GBox: 6 S 800 Getr. / GBox: 6 AS 800 Abgasnorm: Euro 6 / Exhaust Emission Norm: Euro 6	(4)
			3400 700 603 3482 001 166 1878 007 172 3151 000 397	350 MF350 350WGTZ KZIS-4	Getr. / GBox: S5-42 Abgasnorm: Euro 6 / Exhaust Emission Norm: Euro 6	(4)

Karakteristične veličine

Kompresijske ploče spojke

Z/	Za izvedbu s dva diska
400	Vanjski promjer tarne površine 400 mm
Do	Dvostruka spojka, ovisno isključivanje
Du	Dvostruka spojka, neovisno isključivanje
/E	XTend
F	Ravni zamašnjak
G	Spojka s lijevanim kucištem
K	Spojka sa zavojnim oprugama
KM	S membranskom oprugom i polužnim sustavom
M	Spojka s membranskom oprugom
N	Prigon
S	Izvedba sa zakretnim svornjakom
T	S tanjurastom oprugom
XTend	S automatskim podešavanjem
Z	Isključivanje na potez

Diskovi spojke

200	Vanjski promjer 200 mm
CE	Anorganska sinterirana obloga
B/D/E/Z	Elastičnost obloge
BH/GS/GT/GV	Torzijski prigušivač za gospodarska vozila
/E	XTend
W/V	Predublaživač za gospodarska vozila

Ležaj isključivača

...A	Istohodni vanjski prsten
G	Grafitni potporni prsten
GK	Grafitni potporni prsten i kuglični ležaj
GR	Kuglični ležaj s limenim poklopcem
GZ	Glavni cilindar
HHIS	Koncentrični prihvatni cilindar
...I	Prateći unutarnji prsten
KT	Teflonska potisna ploča
KZ	Kuglični ležaj, središnje vođeni
NZ	Radni cilindar
...S	Samocentrirajući unutarnji prsten
...Z	Isključivanje na potez

Prijevodi

(1)	Norma za ispušne plinove: Euro 3
(2)	Norma za ispušne plinove: Euro 4 (D4)
(3)	Norma za ispušne plinove: Euro 5
(4)	Norma za ispušne plinove: Euro 6
(5)	Norma za ispušne plinove: Euro 3 / Euro 4
(6)	Norma za ispušne plinove: Euro 4 / Euro 5
(7)	Norma za ispušne plinove: Euro 5 / Euro 6
(8)	Broj obloga
(9)	Vilica za isključivanje ovjesna [mm]
(10)	Vilica za isključivanje stojeća [mm]
(11)	Vanjski promjer [mm]
(12)	Zamjenski dio zamijenjen s 3400 121 002
(13)	Kod problema s bukom
(14)	Sadrži isključivač i komplet za montažu
(15)	Sadrži dvomaseni zamašnjak, potisnu ploču, disk spojke i isključivač
(16)	Sadrži dvomaseni zamašnjak, potisnu ploču, disk spojke i CSC
(17)	Benzin
(18)	Širina [mm]
(19)	Dizel
(20)	Vozilo može biti opremljeno spojkom različitih veličina
(21)	Vozila mogu biti opremljena s različitim komponentama
(22)	Pogon punjača
(23)	Medij za punjenje: Tekućina za kočnice
(24)	Medij za punjenje: Mineralno ulje
(25)	Za izvoz
(26)	Broj mjenjača
(27)	Duljina ovitka [mm]
(28)	Uvijek izmjenjivati
(29)	Sadržano u 1888
(30)	Sadržano u 3483/3488
(31)	Sadržano u 3488
(32)	Unutarnji promjer [mm]
(33)	Po želji kupca s različitom spojkom
(34)	Duljina kabela [mm]
(35)	Karakteristična veličina
(36)	Kuglični ležaj
(37)	Disk spojke s prigušivačem vibracija
(38)	Snaga [kW]
(39)	Labavi disk spojke
(40)	Verzija za određenu zemlju: Velika Britanija
(41)	Verzija za određenu zemlju: Turska
(42)	Duljina [mm]
(43)	Vrsta montaže: Nije prethodno montirano
(44)	Komplet za montažu ležaja odvajanja
(45)	Izvedba motora
(46)	Profil glavčine
(47)	Ležaj glavčine
(48)	ID-sporednog pogona
(49)	Može se isporučiti samo uz povrat starih dijelova (reparatura; pogon Bielefeld)

Prijevodi

(50) Ugraditi samo, ako je vozilo opremljeno s M-spojkom

(51) Ugraditi samo skupa

(52) Serijski broj

(53) Međuosovinski razmak [mm]

(54) Slijedni ručni mjenjač

(55) Automatizirani ručni mjenjač

(56) Specijalna izvedba

(57) Nepomični disk spojke

(58) Disk spojke s torzijskim oprugama

(59) ZF-pogon

(60) Od serijskog broja

(61) Alternativna garnitura za popravke

(63) Do serijskog broja

(64) Sadrži pričvrzne vijke za kompresijsku ploču

(65) Sadrži pričvrzne vijke za zamašnjak

(66) Sadrži jedan disk spojke

(67) Sadrži dva diska spojke

(68) Za

(69) Za vilicu za isključivanje s brijegom

(70) Za vilicu za isključivanje s valjcima

(71) Za vozila s spojkom s jednim diskom

(72) Za vozila s pojačalom snage spojke

(73) Za vozila s sporednim pogonom

(74) Za vozila s niskotlačnim kočionim uređajem

(75) Za vozila s retarderom

(76) Za vozila s ključnom spojkom pretvarača

(77) Za vozila s spojkom s dva diska

(78) Za unutarnji promjer tanjuraste opruge 100 mm

(79) Za unutarnji promjer tanjuraste opruge 120 mm

(80) Za motore s dvomasenim zamašnjakom

(81) Za motore bez dvomasenog zamašnjaka

(82) Za sporedni pogon

(83) Za OE-broj

(84) Za dubinu zamašnjaka [mm]

(85) Ovisno o izvedbi s različitom spojkom

(86) Dugi stremen

(87) Maks. prenosivi moment motora [Nm]

(88) S zaletnim prstenom

(89) S trajnim podmazivanjem

(90) S usporivačem VR 115E

(91) S cijevnim priključkom za podmazivanje

(92) S osjetnikom

(93) S prstenastim zupčanikom

(94) S priborom

(95) S međuprstenom

(96) Ne za

(97) Ne za broj voznog postroja

(98) Ne za kôd motora

(99) Ne u spoju sa zamjenskim diskom spojke

Prijevod

(100) Samo kao zamjena za navedeni OE br.

(101) Samo u kombinaciji s

(102) Bez zaletnog prstena

(103) Bez cijevnog priključka za podmazivanje

(104) Bez osjetnika

(105) Bez međuprstena

DE

EN

FR

ES

PT

IT

NL

NO

SV

FI

PL

RU

HU

CS

RO

HR

EL

TR

ZH

DE

EN

FR

ES

PT

IT

NL

NO

SV

FI

PL

RU

HU

CS

RO

HR

EL

TR

ZH

Memo

Γενικές πληροφορίες



Όλα τα εξαρτήματα αυτού του καταλόγου επιτρέπεται να τοποθετούνται μόνο από το εκπαιδευμένο προσωπικό ενός συνεργείου αυτοκινήτου.

Για τις απαιτήσεις σας χρειαζόμαστε τον πλήρη αριθμό παραγγελίας, για παράδειγμα:

Σετ συμπλέκτη	3400 122 201
Πλατό συμπλέκτη	3482 083 032
Δίσκος συμπλέκτη	1878 004 832
Έδρανο αποσύμπλεξης	3151 000 034

Εάν έχετε αμφιβολίες, δώστε την ονομασία τύπου και το έτος κατασκευής του οχήματος για το οποίο προορίζεται το επιθυμητό εξάρτημα.

Με την επιφύλαξη παντός δικαιώματος. Δεν επιτρέπεται η αναπαραγωγή ή η χρήση του παρόντος καταλόγου εν όλω ή εν μέρει για τη δημιουργία προσωπικού καταλόγου, χωρίς ρητή άδεια.

Οι κωδικοί εξαρτημάτων των κατασκευαστών οχημάτων παρέχονται μόνο για σκοπούς σύγκρισης. Δεν επιτρέπεται η αναφορά τέτοιου είδους στοιχείων σε παραστατικά αγοράς που απευθύνονται στον κάτοχο του οχήματος.

Οι ισχύοντες γενικοί όροι λειτουργίας υπάρχουν στη διεύθυνση www.zf.com/services/documents

www.zf.com/services/catalog

WebCat

Κατάλογος online

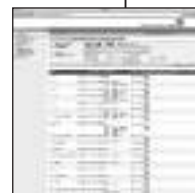

InCat

Ηλεκτρονικός κατάλογος



PrintCat

Τυπωμένοι κατάλογοι



Περιεχόμενα

Index	U2
Σύμβολα	U5 - U6
Γενικές πληροφορίες	V91
Δομή καταλόγου	V92
Κύρια μεγέθη	V92
Μεταφράσεις	V93 - V95
Αριθμητικός κατάλογος	842 - 884
Συγκριτικός κατάλογος	884 - 926
Νέες καταχωρίσεις	927 - 928
Αλλαγμένος αριθμός παραγγελίας	929
Διεγραμμένοι αριθμοί	930
Πίνακας διαστάσεων για προφίλ πλήμνης	931
Πίνακας διαστάσεων για δίσκους σφονδύλου	932 - 933

Δομή καταλόγου

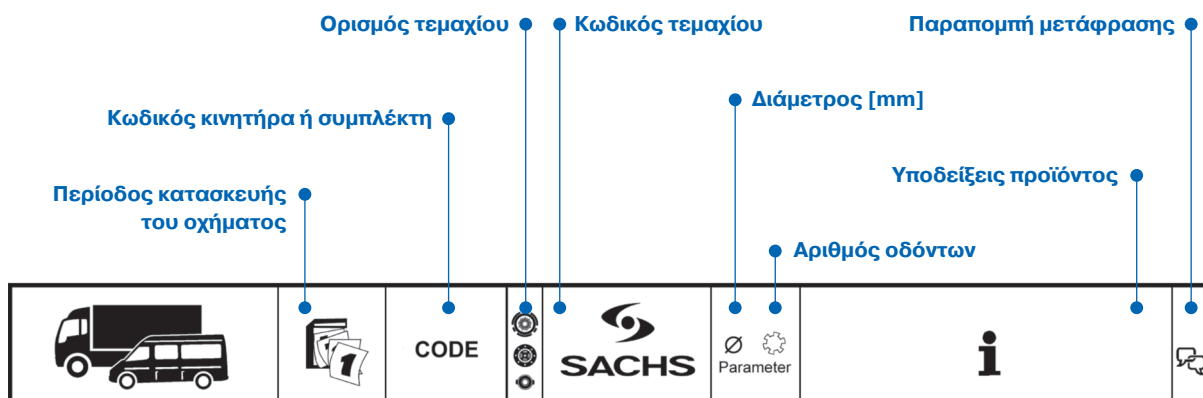

DAF

LF		10.13 -				
LF 180		PX-5135	<ul style="list-style-type: none"> 3400 700 465 <ul style="list-style-type: none"> 3482 000 859 1878 005 601 3151 000 651 3400 700 464 <ul style="list-style-type: none"> 3482 000 859 1878 005 600 3151 000 651 3400 700 603 <ul style="list-style-type: none"> 3482 001 166 1878 007 172 3151 000 397 	<ul style="list-style-type: none"> 362 10 <ul style="list-style-type: none"> MF362 362WGTZ KZIS-4 362 10 <ul style="list-style-type: none"> MF362 362WGTZ KZIS-4 350 <ul style="list-style-type: none"> MF350 350WGTZ KZIS-4 	<ul style="list-style-type: none"> Getr. / GBox: 6 S 700 Getr. / GBox: 6 AS 700 Abgasnorm: Euro 6 / Exhaust Emission Norm: Euro 6 Getr. / GBox: 6 S 800 Getr. / GBox: 6 AS 800 Abgasnorm: Euro 6 / Exhaust Emission Norm: Euro 6 Getr. / GBox: S5-42 Abgasnorm: Euro 6 / Exhaust Emission Norm: Euro 6 	<ul style="list-style-type: none"> (4) (4) (4)
LF 210		PX-5157	<ul style="list-style-type: none"> 3400 700 465 <ul style="list-style-type: none"> 3482 000 859 1878 005 601 3151 000 651 3400 700 464 <ul style="list-style-type: none"> 3482 000 859 1878 005 600 3151 000 651 3400 700 603 <ul style="list-style-type: none"> 3482 001 166 1878 007 172 3151 000 397 	<ul style="list-style-type: none"> 362 10 <ul style="list-style-type: none"> MF362 362WGTZ KZIS-4 362 10 <ul style="list-style-type: none"> MF362 362WGTZ KZIS-4 350 <ul style="list-style-type: none"> MF350 350WGTZ KZIS-4 	<ul style="list-style-type: none"> Getr. / GBox: 6 S 700 Getr. / GBox: 6 AS 700 Abgasnorm: Euro 6 / Exhaust Emission Norm: Euro 6 Getr. / GBox: 6 S 800 Getr. / GBox: 6 AS 800 Abgasnorm: Euro 6 / Exhaust Emission Norm: Euro 6 Getr. / GBox: S5-42 Abgasnorm: Euro 6 / Exhaust Emission Norm: Euro 6 	<ul style="list-style-type: none"> (4) (4) (4)

Κύρια μεγέθη

Πλατό συμπλέκτη

Z/	Για έκδοση διπλού δίσκου
400	Εξωτερική διάμετρος επιφάνειας τριβής 400 mm
Do	Διπλός συμπλέκτης, εξαρτώμενη αποσύμπλεξη
Du	Διπλός συμπλέκτης, ανεξάρτητη αποσύμπλεξη
/E	XTend
F	Λεπτός σφόνδυλος
G	Συμπλέκτης με χυτό κέλυφος
K	Συμπλέκτης ελικοειδών ελατηρίων
KM	Με ελατήριο μεμβράνης και μοχλικό σύστημα
M	Συμπλέκτης ελατηρίων μεμβράνης
N	Δυναμοδότης
S	Τύπος με πείρο στρέψης
T	Με δισκοειδές ελατήριο
XTend	Με αυτόματη ρύθμιση
Z	Αποσύμπλεξη με έλξη

Δίσκος συμπλέκτη

200	Εξωτερική διάμετρος 200 mm
CE	Ανόργανη επένδυση επίτηξης
B/D/E/Z	Ελατήρια επενδύσεων
BH/GS/GT/GV	Αποσβεστήρας στρέψης για οχήματα ΔΧ
/E	XTend
W/V	Αποσβεστήρας για οχήματα ΔΧ

Ρουλεμάν αποσύμπλεξης

...A	Παρασυρόμενος εξωτερικός δακτύλιος
G	Δακτύλιος εκκίνησης από γραφίτη
GK	Δακτύλιος εκκίνησης από γραφίτη με ρουλεμάν
GR	Ρουλεμάν με μεταλλικό πώμα
GZ	Εντολοδόχος κύλινδρος
HHIS	Ομόκεντρος εντολοδόχος κύλινδρος
...I	Παρασυρόμενος εσωτερικός δακτύλιος
KT	Ροδέλα τεφλόν
KZ	Ρουλεμάν, κεντρικής οδήγησης
NZ	Εντολοδόχος κύλινδρος
...S	Αυτοκεντραριζόμενος εσωτερικός δακτύλιος
...Z	Αποσύμπλεξη με έλξη

Μεταφράσεις

- (1) Πρότυπο καυσαερίων: Euro 3
- (2) Πρότυπο καυσαερίων: Euro 4 (D4)
- (3) Πρότυπο καυσαερίων: Euro 5
- (4) Πρότυπο καυσαερίων: Euro 6
- (5) Πρότυπο καυσαερίων: Euro 3 / Euro 4
- (6) Πρότυπο καυσαερίων: Euro 4 / Euro 5
- (7) Πρότυπο καυσαερίων: Euro 5 / Euro 6
- (8) Αριθμός των επενδύσεων
- (9) Δίχαλο αποσύμπλεξης αναρτημένο [mm]
- (10) Δίχαλο αποσύμπλεξης όρθιο [mm]
- (11) Εξωτερική διάμετρος [mm]
- (12) Εξάρτημα αντικατάστασης, αντικατεστημένο από το 3400 121 002
- (13) Σε περίπτωση προβλημάτων από θορύβους
- (14) Περιέχει έδρανο αποσύμπλεξης και κιτ τοποθέτησης
- (15) Περιέχει σφόνδυλο διπλής μάζας (ZMS), πλατό συμπλέκτη, δίσκο συμπλέκτη και έδρανο αποσύμπλεξης
- (16) Περιέχει σφόνδυλο διπλής μάζας (ZMS), πλατό συμπλέκτη, δίσκο συμπλέκτη και CSC
- (17) Βενζίνη
- (18) Πλάτος [mm]
- (19) Ντίτζελ
- (20) Το όχημα ενδέχεται να είναι εξοπλισμένο με διαφορετικές διαστάσεις συμπλέκτη
- (21) Τα οχήματα ενδέχεται να είναι εξοπλισμένα με διαφορετικά εξαρτήματα
- (22) Κιβώτιο ταχυτήτων Fuller
- (23) Μέσο πλήρωσης: Υγρό φρένων
- (24) Μέσο πλήρωσης: Ορυκτέλαιο
- (25) Για εξαγωγή
- (26) Κωδικός κιβωτίου ταχυτήτων
- (27) Μήκος περιβλήματος [mm]
- (28) Πάντοτε ανανέωση
- (29) Στο 1888 περιλαμβάνεται
- (30) Στο 3483/3488 περιλαμβάνεται
- (31) Στο 3488 περιλαμβάνεται
- (32) Εσωτερική διάμετρος [mm]
- (33) Ανάλογα με την επιθυμία του πελάτη με διαφορετικό συμπλέκτη
- (34) Μήκος καλωδίου [mm]
- (35) Κύριο μέγεθος
- (36) Ρουλεμάν
- (37) Δίσκος συμπλέκτη με προαποσβεστήρα
- (38) Ίσχύς [kW]
- (39) Λασκαρισμένος δίσκος συμπλέκτη
- (40) Έκδοση χώρας: Μεγάλη Βρετανία
- (41) Έκδοση χώρας: Τουρκία
- (42) Μήκος [mm]
- (43) Τρόπος συναρμολόγησης: Μη προεγκατεστημένο
- (44) Σετ συναρμολόγησης με ρουλεμάν αποσύμπλεξης
- (45) Μοντέλο κινητήρα
- (46) Προφίλ πλήμνης
- (47) Βελονοφόρο έδρανο
- (48) ID δυναμοδότη

Μεταφράσεις

(49) Προσφέρεται μόνο σε επιστροφή παλαιού εξαρτήματος (επισκευή, εργοστάσιο Bielefeld)

(50) Τοποθέτηση μόνο όταν το όχημα είναι εξοπλισμένο με συμπλέκτη M

(51) Τοποθέτηση μόνο μαζί

(52) Κωδικός παραγωγής

(53) Μεταξόνιο [mm]

(54) Σειριακό μηχανικό κιβώτιο

(55) Μηχανικό κιβώτιο ταχυτήτων, ημιαυτόματο

(56) Ειδική έκδοση

(57) Δίσκος χωρίς ελατήρια

(58) Δίσκος με ελατήρια στρέψης

(59) Κιβώτιο ταχυτήτων ZF

(60) Από αριθμό παραγωγής

(61) Εναλλακτικό σετ επισκευής

(63) Έως αριθμό παραγωγής

(64) Περιλαμβάνει βίδες στερέωσης του πλατό

(65) Περιλαμβάνει βίδες στερέωσης σφονδύλου

(66) Περιλαμβάνει ένα δίσκο συμπλέκτη

(67) Περιλαμβάνει δύο δίσκους συμπλέκτη

(68) Για

(69) Για δίχαλο αποσύμπλεξης με έκκεντρο

(70) Για δίχαλο αποσύμπλεξης με ράουλα

(71) Για οχήματα με μονόδισκο συμπλέκτη

(72) Για οχήματα με ενισχυτή δύναμης συμπλέκτη

(73) Για οχήματα με δυναμοδότη

(74) Για οχήματα με σύστημα πέδησης χαμηλής πίεσης

(75) Για οχήματα με επιβραδυντή

(76) Για οχήματα με μονάδα μετατροπέα-συμπλέκτη

(77) Για οχήματα με συμπλέκτη διπλού δίσκου

(78) Για εσωτερική διάμετρο ελατηριωτού διαφράγματος 100 mm

(79) Για εσωτερική διάμετρο ελατηριωτού διαφράγματος 120 mm

(80) Για κινητήρες με σφόνδυλο διπλής μάζας

(81) Για κινητήρες χωρίς σφόνδυλο διπλής μάζας

(82) Για δυναμοδότη

(83) Για αριθμό OE

(84) Για βάθος σφονδύλου [mm]

(85) Ανάλογα με την έκδοση με διαφορετικό συμπλέκτη

(86) Μακρύ δίχαλο

(87) Μέγιστη ωφέλιμη ροπή κινητήρα [Nm]

(88) Με δακτύλιο εκκίνησης

(89) Με λίπανση διαρκείας

(90) Με επιβραδυντή VR 115E

(91) Με λιπαινόμενο σύνδεσμο σωλήνα

(92) Με αισθητήρα

(93) Με οδοντωτή στεφάνη

(94) Με αξεσουάρ

(95) Με ενδιάμεσο δακτύλιο

(96) Όχι για

(97) Όχι για αριθμό πλασιού

(98) Όχι για αριθμό κινητήρα

Μεταφράσεις

(99) Όχι σε συνδυασμό με ανταλλακτικό δίσκο συμπλέκτη

(100) Μόνο ως αντικατάσταση για τους αναφερόμενους αρ. ΟΕ (γνήσια ανταλλακτικά)

(101) Μόνο σε συνδυασμό με

(102) Χωρίς δακτύλιο εκκίνησης

(103) Χωρίς λιπαινόμενο σύνδεσμο σωλήνα

(104) Χωρίς αισθητήρα

(105) Χωρίς ενδιάμεσο δακτύλιο

DE

EN

FR

ES

PT

IT

NL

NO

SV

FI

PL

RU

HU

CS

RO

HR

EL

TR

ZH

Memo

Genel bilgiler



Bu katalogta belirtilen tüm ürünler sadece atölyede ve eğitilmiş personel tarafından monte edilmelidir.

Talepleriniz için tam sipariş numarası gereklidir, örneğin:

Debriyaj kiti	3400 122 201
Debriyaj baskı plakası	3482 083 032
Debriyaj diskisi	1878 004 832
Debriyaj rulmanı	3151 000 034

Kararsızlık durumunda istenilen ürün için tespit edilmiş olan tip tanımını ve aracın model yılını belirtin.

Tüm hakları saklıdır. Açık bir onay alınmadığı sürece bu kataloğun çoğaltılmasına veya başka bir katalog oluşturmak için kısmen de olsa kullanılmasına izin verilmez.

Araç üreticilerinin yedek parça numaraları sadece karşılaştırma amaçlıdır. Bu tür bilgilerin araç sahibi için oluşturulan faturalarda kullanılmasına izin verilmez.

Güncel genel iş şartlarını
www.zf.com/services/documents
adresini altında bulabilirsiniz.

www.zf.com/services/catalog

WebCat
Online katalog

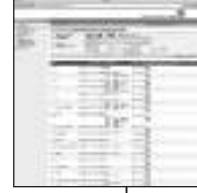

InCat
Elektronik katalog



PrintCat
Basılı kataloglar



İçindekiler

Index	U2
Semboller	U5 - U6
Genel bilgiler	V97
Kataloğun yapısı	V98
Karakteristik değerler	V98
Çeviriler	V99 - V101
Aritmetik liste	842 - 884
Karşılaştırma listesi	884 - 926
Yeni kayıtlar	927 - 928
Değiştirilen sipariş numarası	929
İptal edilen numaralar	930
Göbek profilleri için ölçüm tablosu	931
Volan diskleri için ölçüm tablosu	932 - 933

Katalogun yapısı

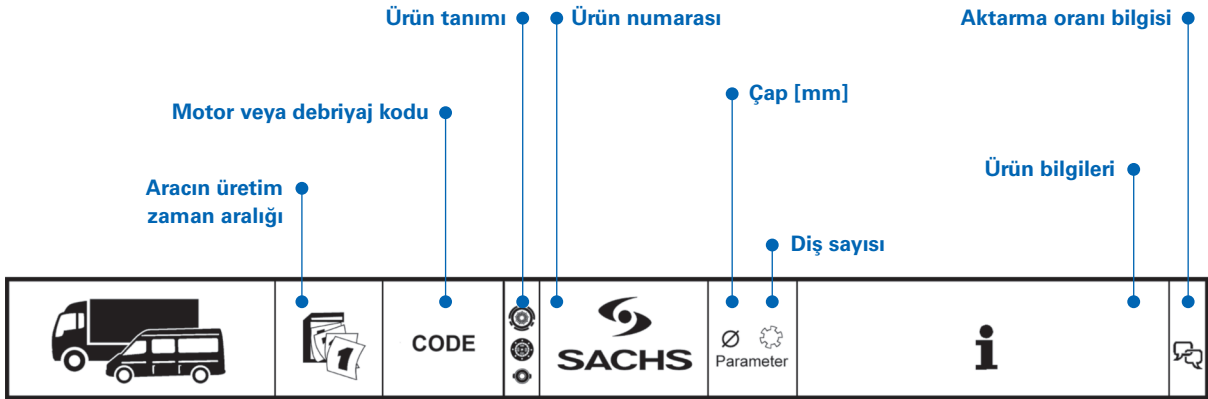

DAF

LF		10.13 -				
LF 180		PX-5135	<p>3400 700 465 3482 000 859 1878 005 601 3151 000 651</p> <p>3400 700 464 3482 000 859 1878 005 600 3151 000 651</p> <p>3400 700 603 3482 001 166 1878 007 172 3151 000 397</p>	<p>362 10 MF362 362WGTZ KZIS-4</p> <p>362 10 MF362 362WGTZ KZIS-4</p> <p>350 MF350 350WGTZ KZIS-4</p>	<p>Getr. / GBox: 6 S 700 Getr. / GBox: 6 AS 700 Abgasnorm: Euro 6 / Exhaust Emission Norm: Euro 6</p> <p>Getr. / GBox: 6 S 800 Getr. / GBox: 6 AS 800 Abgasnorm: Euro 6 / Exhaust Emission Norm: Euro 6</p> <p>Getr. / GBox: S5-42 Abgasnorm: Euro 6 / Exhaust Emission Norm: Euro 6</p>	<p>(4)</p> <p>(4)</p> <p>(4)</p>
LF 210		PX-5157	<p>3400 700 465 3482 000 859 1878 005 601 3151 000 651</p> <p>3400 700 464 3482 000 859 1878 005 600 3151 000 651</p> <p>3400 700 603 3482 001 166 1878 007 172 3151 000 397</p>	<p>362 10 MF362 362WGTZ KZIS-4</p> <p>362 10 MF362 362WGTZ KZIS-4</p> <p>350 MF350 350WGTZ KZIS-4</p>	<p>Getr. / GBox: 6 S 700 Getr. / GBox: 6 AS 700 Abgasnorm: Euro 6 / Exhaust Emission Norm: Euro 6</p> <p>Getr. / GBox: 6 S 800 Getr. / GBox: 6 AS 800 Abgasnorm: Euro 6 / Exhaust Emission Norm: Euro 6</p> <p>Getr. / GBox: S5-42 Abgasnorm: Euro 6 / Exhaust Emission Norm: Euro 6</p>	<p>(4)</p> <p>(4)</p> <p>(4)</p>

Karakteristik değerler

Debriyaj baskı plakaları	
Z/	İki diskli model
400	Sürtünme yüzeyi dış çapı 400 mm
Do	Çift debriyaj, bağımlı ayırmalı
Du	Çift debriyaj, bağımsız ayırmalı
/E	XTend
F	Düz volan
G	Döküm mahfazalı debriyaj
K	Helezoni yaylı debriyaj
KM	Membran yay ve kol sistemli
M	Membran yaylı debriyaj
N	Yardımcı tahrik
S	Döner saplamalı tip
T	Yaylı plakalı
XTend	Otomatik ayarlama ile
Z	Telle ayırmalı

Debriyaj diskleri	
200	Dış çap 200 mm
CE	Anorganik sinter kaplama
B/D/E/Z	Balata yayları
BH/GS/GT/GV	Ticari araçlar için torsiyon sönümleyici
/E	XTend
W/V	Ticari araçlar için ön sönümleyici

Ayırma rulmanı	
...A	Birlikte dönen dış halka
G	Grafit baskı halkası
GK	Grafit baskı halkası ve rulman
GR	Sac kapaklı rulman
GZ	Debriyaj merkezi
HHIS	Konsantrik alt debriyaj merkezi
...I	Birlikte dönen iç halka
KT	Teflon yol verme diski
KZ	Rulman, merkezi kılavuzlu
NZ	Alt debriyaj merkezi
...S	Kendinden merkezlemeli iç halka
...Z	Telle ayırmalı

Çeviriler

(1)	Atık gaz normu: Euro 3
(2)	Atık gaz normu: Euro 4 (D4)
(3)	Atık gaz normu: Euro 5
(4)	Atık gaz normu: Euro 6
(5)	Atık gaz normu: Euro 3 / Euro 4
(6)	Atık gaz normu: Euro 4 / Euro 5
(7)	Atık gaz normu: Euro 5 / Euro 6
(8)	Balata adeti
(9)	Asılı debriyaj rulmanı çatalı [mm]
(10)	Sabit debriyaj rulmanı çatalı [mm]
(11)	Dış çap [mm]
(12)	Değiştirme parça, 3400 121 002 ile değiştirildi
(13)	Ses problemlerinde
(14)	Debriyaj rulmanı ve montaj setini içerir
(15)	ZMS, debriyaj baskı plakası, debriyaj diski ve debriyaj rulmanı içerir
(16)	ZMS, debriyaj baskı plakası, debriyaj diski ve CSC içerir
(17)	Benzin
(18)	Genişlik [mm]
(19)	Dizel
(20)	Araç farklı debriyaj boyutlarıyla donatılmış olabilir
(21)	Araçlar farklı komponentlerle donatılmış olabilir
(22)	Fuller şanzıman
(23)	Dolum sıvısı: Fren hidroliği
(24)	Dolum sıvısı: Madeni yağ
(25)	İhracat için
(26)	Şanzıman numarası
(27)	Zıvana uzunluğu [mm]
(28)	Her zaman yenileyin
(29)	1888 içeriğine dahil
(30)	3483/3488 içeriğine dahil
(31)	3488 içeriğine dahil
(32)	İç çap [mm]
(33)	Müşteri talebine göre farklı debriyaj ile
(34)	Kablo uzunluğu [mm]
(35)	Karakteristik değer
(36)	Rulman
(37)	Ön tamponlu debriyaj diski
(38)	Güç [kW]
(39)	Gevşek debriyaj diski
(40)	Ülkere özgü tasarım: İngiltere
(41)	Ülkere özgü tasarım: Türkiye
(42)	Uzunluk [mm]
(43)	Montaj türü: Önceden monte edilmemiş
(44)	Ayırma rulmanı için montaj seti
(45)	Motor yapı türü
(46)	Göbek profili
(47)	İğneli yatak
(48)	PTO ID'si
(49)	Yalnızca eski parça iadesinde teslim edilebilir (tamir; Bielefeld fabrikası)

Çeviriler

(50) Sadece, araç M debriyaj ile donatılmış ise monte edilmelidir

(51) Sadece birlikte monte edin

(52) Üretim numarası

(53) Dingil mesafesi [mm]

(54) Manuel şanzıman, ardışık

(55) Manuel şanzıman, otomatikleştirilmiş

(56) Özel tasarım

(57) Sabit debriyaj diskisi

(58) Burulma kirişli debriyaj diskisi

(59) ZF şanzıman

(60) Minimum üretim numarası

(61) Alternatif onarım seti

(63) Üretim numarasına kadar

(64) Baskı plakası tespit vidalarını içerir

(65) Volan dişlisi tespit vidalarını içerir

(66) Bir debriyaj diskisi içerir

(67) İki debriyaj diskisi içerir

(68) İçin

(69) Kamlı ayırma çatalı için

(70) Makaralı ayırma çatalı için

(71) Tek diskli taşıtlar için

(72) Servo debriyajlı taşıtlar için

(73) Yardımcı tahrik sistemli taşıtlar için

(74) Vakumlu fren tertibatlı taşıtlar için

(75) Retarderli taşıtlar için

(76) Konvertör ve debriyaj üniteli taşıtlar için

(77) İki diskli debriyajlı taşıtlar için

(78) Membran yayı iç çapı 100 mm için

(79) Membran yayı iç çapı 120 mm için

(80) Çift kütleli volanı olan motorlar için

(81) Çift kütleli volanı olmayan motorlar için

(82) Yardımcı tahrik sistemi için

(83) OE numarası için

(84) Volan derinliği için [mm]

(85) Tipine göre farklı debriyaj ile

(86) Uzun kol

(87) Aktarılabilen maks. motor torku [Nm]

(88) Baskı halkası ile

(89) Sürekli yağlamalı

(90) Retarder VR 115E ile

(91) Yağlama borusu bağlantısı ile

(92) Sensör ile

(93) Dişli çarklı

(94) Aksesuar ile

(95) Ara halkası ile

(96) Uygun değildir

(97) Şasi numarası için değildir

(98) Motor numarası için uygun değil

(99) Yedek parça debriyaj diskisi ile değil

Çeviriler

(100) Sadece belirtilen OE numaraları için

(101) Sadece birlikte kullanılabilir

(102) Baskı halkası yok

(103) Yağlama borusu bağlantısı yok

(104) Sensör yok

(105) Ara halkası yok

DE

EN

FR

ES

PT

IT

NL

NO

SV

FI

PL

RU

HU

CS

RO

HR

EL

TR

ZH

DE

EN

FR

ES

PT

IT

NL

NO

SV

FI

PL

RU

HU

CS

RO

HR

EL

TR

ZH

Memo

概况



本目录中列出的所有产品只允许由汽车专业维修厂的专业人员进行安装。

为满足您的需求，请提供完整的订单信息，例如：

离合器套件	3400 122 201
离合器压盘	3482 083 032
离合器从动盘	1878 004 832
分离轴承	3151 000 034

如有疑问，请给出车辆型号和制造年份，
以此可以确定您想要的零件。

保留所有权利。未获得明确许可的情况下，
不得复印或者分享此目录创建自有目录（包括节选）。

车辆制造商的备件编号仅用于比较目的。
不允许使用车辆所有者发票中的此类信息。

目前的一般商业条款请参见
www.zf.com/services/documents

www.zf.com/services/catalog

WebCat

在线目录

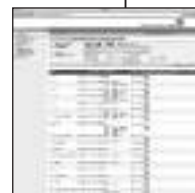

InCat

电子目录



PrintCat

印刷式目录



索引

Index	U2
符号	U5 - U6
概况	V103
目录结构	V104
特征值	V104
译文	V105 - V107
零件号列表	842 - 884
号码对应关系表	884 - 926
产品增补表	927 - 928
修订版零件号	929
停产部件表	930
轮毂断面的尺寸表	931
飞轮的尺寸表	932 - 933

目录结构

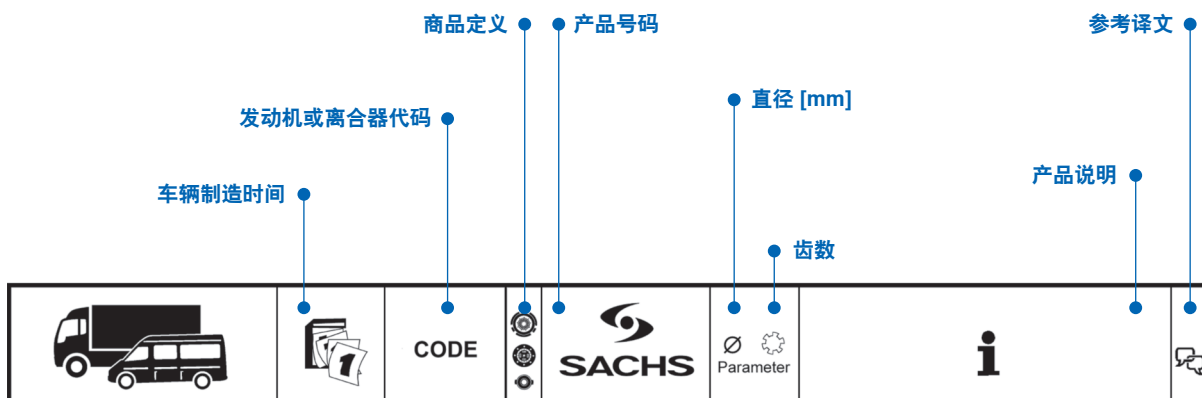

DAF

LF		10.13 -				
LF 180		PX-5135	3400 700 465 3482 000 859 1878 005 601 3151 000 651	362 10 MF362 362WGTZ KZIS-4	Getr. / GBox: 6 S 700 Getr. / GBox: 6 AS 700 Abgasnorm: Euro 6 / Exhaust Emission Norm: Euro 6	(4)
			3400 700 464 3482 000 859 1878 005 600 3151 000 651	362 10 MF362 362WGTZ KZIS-4	Getr. / GBox: 6 S 800 Getr. / GBox: 6 AS 800 Abgasnorm: Euro 6 / Exhaust Emission Norm: Euro 6	(4)
			3400 700 603 3482 001 166 1878 007 172 3151 000 397	350 MF350 350WGTZ KZIS-4	Getr. / GBox: S5-42 Abgasnorm: Euro 6 / Exhaust Emission Norm: Euro 6	(4)
LF 210		PX-5157	3400 700 465 3482 000 859 1878 005 601 3151 000 651	362 10 MF362 362WGTZ KZIS-4	Getr. / GBox: 6 S 700 Getr. / GBox: 6 AS 700 Abgasnorm: Euro 6 / Exhaust Emission Norm: Euro 6	(4)
			3400 700 464 3482 000 859 1878 005 600 3151 000 651	362 10 MF362 362WGTZ KZIS-4	Getr. / GBox: 6 S 800 Getr. / GBox: 6 AS 800 Abgasnorm: Euro 6 / Exhaust Emission Norm: Euro 6	(4)
			3400 700 603 3482 001 166 1878 007 172 3151 000 397	350 MF350 350WGTZ KZIS-4	Getr. / GBox: S5-42 Abgasnorm: Euro 6 / Exhaust Emission Norm: Euro 6	(4)

特征值

离合器压盘	
2/	用于双皮带轮的型号
400	摩擦面外直径 400 mm
Do	复式离合器, 依赖性断联
Du	复式离合器, 独立性断联
/E	XTend
F	平面飞轮
G	带铸铁外壳的离合器
K	螺旋弹簧离合器
KM	带膜片弹簧和杠杆系统
M	膜片弹簧离合器
N	取力器
S	吊环螺栓配置
T	带碟形弹簧
XTend	带自动调整
Z	拉式

离合器从动盘	
200	外径 200 mm
CE	无机烧结敷层
B/D/E/Z	面片弹性
BH/GS/GT/GV	用于商用车的扭转减振器
/E	XTend
W/V	用于载货汽车的预减震器

分离轴承	
...A	旋转外环
G	石墨止推环
GK	石墨起动环和球轴承
GR	球轴承带板盖
GZ	主泵
HHIS	同心分泵
...I	旋转内环
KT	四氟乙烯起动盘
KZ	球轴承, 中央配置
NZ	分泵
...S	自行居中内环
...Z	拉式

译文

- (1) 废气排放标准：欧 3
- (2) 废气排放标准：欧 4 (D4)
- (3) 废气排放标准：欧 5
- (4) 废气排放标准：欧 6
- (5) 废气排放标准：欧3 / 欧4
- (6) 废气排放标准：欧4 / 欧5
- (7) 废气排放标准：欧5 / 欧6
- (8) 制动片个数
- (9) 悬置的分离拨叉 [mm]
- (10) 竖立的分离拨叉 [mm]
- (11) 外径 [mm]
- (12) 使用 3400 121 002 更换零件
- (13) 当出现噪声问题时
- (14) 包含分离轴承和安装套件
- (15) 包含双质量飞轮、离合器压盘、从动盘和分离轴承
- (16) 包含双质量飞轮、离合器压盘、从动盘和 CSC
- (17) 汽油
- (18) 宽度 [mm]
- (19) 柴油
- (20) 车辆可配备不同尺寸的离合器
- (21) 车辆可配备不同的零部件
- (22) Fuller 变速箱
- (23) 填充介质：制动液
- (24) 填充介质：矿物油
- (25) 用于出口
- (26) 变速箱号码
- (27) 套筒长度 [mm]
- (28) 始终更换
- (29) 包含在1888 之内
- (30) 包含在3483/3488 之内
- (31) 包含在3488... .. 之内
- (32) 内径 [mm]
- (33) 根据客户需求，选用不同的离合器
- (34) 电缆长度 [mm]
- (35) 参数
- (36) 球轴承
- (37) 带预减震器的离合器从动盘
- (38) 功率[千瓦]
- (39) 可滑动的离合器从动盘
- (40) 国家规格：英国
- (41) 国家规格：土耳其
- (42) 长度 [mm]
- (43) 安装类型：未预安装
- (44) 用于分离轴承的安装套件
- (45) 发动机型式
- (46) 轴毂花键
- (47) 滚针轴承
- (48) 取力器代码
- (49) 只有在旧部件返还情况下才能供货（修理；Bielefeld工厂）

译文

(50) 仅安装于配备M型离合器的车辆

(51) 仅可共同安装

(52) 生产号码

(53) 轴距 [mm]

(54) 顺序式手动变速箱

(55) 机械自动变速箱

(56) 特殊配置

(57) 刚性离合器从动盘

(58) 带扭转减振器的离合器从动盘

(59) ZF变速箱

(60) 从产品号码

(61) 可选维修包

(63) 至生产号码

(64) 包含压盘固定螺钉

(65) 包含飞轮固定螺钉

(66) 包括 1 个离合器从动盘

(67) 包括 2 个离合器从动盘

(68) 用于

(69) 用于带凸轮的分离拨叉

(70) 对带滚轮的分离拨叉

(71) 用于配备单盘式离合器的车辆

(72) 用于配备离合器增压装置的车辆

(73) 用于带取力器的车辆

(74) 用于配备低压制动装置的车辆

(75) 用于配备减速器的车辆

(76) 用于配备变矩离合器的车辆

(77) 用于配备双片式离合器的车辆

(78) 用于膜片弹簧内径为 100 mm 的型号

(79) 用于膜片弹簧内径为 120 mm 的型号

(80) 用于配备双质量飞轮的发动机

(81) 用于无双质量飞轮的发动机

(82) 用于辅助取力器

(83) 用于原厂号码

(84) 用于飞轮厚度 [mm]

(85) 根据具体配置，选用不同的离合器

(86) 长手柄

(87) 最大可传输发动机扭矩 [Nm]

(88) 带启动环

(89) 永久润滑

(90) 配备VR 115E减速器

(91) 带润滑管连接

(92) 带传感器

(93) 带链轮齿

(94) 带附件

(95) 带间隔环

(96) 不适用于

(97) 不适用于底盘号码

(98) 不适用于发动机号码

(99) 不能与更换离合器从动盘结合

译文

(100) 仅可替代列明原厂号的部件

(101) 仅连接与

(102) 无启动环

(103) 无润滑管连接

(104) 无传感器

(105) 无间隔环

DE

EN

FR

ES

PT

IT

NL

NO

SV

FI

PL

RU

HU

CS

RO

HR

EL









TR

















Memo

ZH











		CODE				
--	--	------	--	---	---	---



ASTRA

BE-Serie						
BE 8440 F		Fiat8210		3482 125 132	420 MF420	
				1878 001 136	420 10 420GTZ	
				3151 000 515	KZIS-4	
Betonmischer / Concrete Mixer 20 257				1878 000 959 ▲	380 10 380GTZ	für Nebenantrieb / for PTO (82)
				3151 000 515	KZIS-4	für Nebenantrieb / for PTO (82)
Betonmischer / Concrete Mixer 304 F/FP/M/MP				3482 124 516	430 GMF430	
				1878 002 878	420 10 420GTZ	
				3151 208 001	KZI-5	

HD7-Serie						
42.38		8210.42K		3400 117 801	430 10 MFZ430	
64.38				3482 083 032	430WGTZ	
66.38				1878 085 741	KZISZ-5	
84.38				3151 000 144		
42.42		8210.42L		3400 117 801	430 10 MFZ430	
64.42				3482 083 032	430WGTZ	
66.42				1878 085 741	KZISZ-5	
84.42				3151 000 144		
64.45		8280.42B		3400 117 801	430 10 MFZ430	
66.45				3482 083 032	430WGTZ	
84.45				1878 085 741	KZISZ-5	
86.45				3151 000 144		
64.52		8280.42S		3400 117 801	430 10 MFZ430	
66.52				3482 083 032	430WGTZ	
84.52				1878 085 741	KZISZ-5	
86.52				3151 000 144		







AVIA

D-Line 10.01 -						
D 60	10.01 -	CumminsSB150/170, Euro3		3482 000 461	362 MF362	Getr. / GBox: ZF S5-42
D 60	10.01 -			1878 019 001	362 10 362TB	->Chass. 5A003732 Getr. / GBox: ZF S5-42
D 75	10.01 -			1878 000 515	362 10 362GTZ	Chass. 5A003733-> Getr. / GBox: ZF S5-42
D 75 T	10.01 -					
D 75	10.01 -					
D 75 T	10.01 -					
D 90	10.01 -	CumminsSB150/170, Euro3		3482 000 461	362 MF362	Getr. / GBox: ZF 6S850
D 90	10.01 -			1878 019 001	362 10 362TB	->Chass. 5A003732 Getr. / GBox: ZF 6S850
				1878 000 515	362 10 362GTZ	Chass. 5A003733-> Getr. / GBox: ZF 6S850
D 100	10.01 -	ISBe150, ISBe170		3482 125 512	362 MF362	
D 100	10.01 -			1878 019 001	362 10 362TB	
D 120	10.01 -					
D 120	10.01 -			3151 199 001	KZIS-3	

TRUCK						
D 60 / D75 (zgg.6200kg)		CumminsSB150, Euro3		3482 000 461	362 MF362	Getr. / GBox: ZF S5-42
				1878 019 001	362 10 362TB	->Chass. 5A003732 Getr. / GBox: ZF S5-42
				1878 000 515	362 10 362GTZ	Chass. 5A003733-> Getr. / GBox: ZF S5-42

		CODE				
--	--	------	--	---	---	---



AVIA

TRUCK						
D 60 / D75 (zgg.7490kg) D 75 T Urban Tractor (zgg.10990kg)		CumminsISB15 0/170, Euro3	 3482 000 461	362 MF362	Getr. / GBox: ZF S5-42	
			 1878 019 001	362 10 362TB	->Chass. 5A003732 Getr. / GBox: ZF S5-42	
			 1878 000 515	362 10 362GTZ	Chass. 5A003733-> Getr. / GBox: ZF S5-42	
D 90 (zgg. 9000kg)		CumminsISB15 0/170, Euro3	 3482 000 461	362 MF362	Getr. / GBox: ZF 6S850	
			 1878 019 001	362 10 362TB	->Chass. 5A003732 Getr. / GBox: ZF 6S850	
			 1878 000 515	362 10 362GTZ	Chass. 5A003733-> Getr. / GBox: ZF 6S850	

BARKAS

B 1000 Kasten/Box (KM) 01.76 -						
1.0	01.76 - 12.91	353-1/B1000	 3000 325 001 # ⊗ 3082 967 001 ⊗ 1862 767 001 ⊙ 3159 900 001	180 24 MX180 180LB KT-0		



BMC

PROFESSIONAL 09.96 -						
625 VHX 628 DHZ		ISBe4250B, ISBe5250B, ISBe5285	 3482 000 474	395 MF395		
			 1878 003 899	395 10 395WGTZ		
938 EDB 938 EDE 938 EDE 938 ETE 938 ETB		ISLe5380	 3482 083 113	430 MFZ430		

DAEWOO











































TRUCK						
365 T			 1800 125 602 ⊗ 1888 042 009 ⊗ 1878 000 968 ⊙ 3151 066 004	380 10 GF2/380 380GTZ		

DAF

F 900						
FA 900 BDF FA 900 BDT	11.81 - 11.88 11.83 - 11.88	DT615, DF615	 3400 124 901 ⊗ 3482 060 132 ⊗ 1861 777 037 ⊙ 3151 199 001	350 10 MF350 350GTD KZIS-3	Nabenprofil / Hub Profile: 1 1/2"-10N	(46)
F 1100						
FA 1100 DD FA 1100 DF FA 1100 DNTD FA 1100 DT	01.78 - 12.81 11.81 - 11.88 12.86 - 11.90 11.83 - 11.88	DD575, DT615, DNTD620, DF615	 3400 124 901 ⊗ 3482 060 132 ⊗ 1861 777 037 ⊙ 3151 199 001	350 10 MF350 350GTD KZIS-3	Nabenprofil / Hub Profile: 1 1/2"-10N	(46)
F 1200						
FA 1200 DD	01.69 - 12.81	DD575	 3400 124 901 ⊗ 3482 060 132 ⊗ 1861 777 037 ⊙ 3151 199 001	350 10 MF350 350GTD KZIS-3	Nabenprofil / Hub Profile: 1 1/2"-10N	(46)

		CODE				
--	--	------	--	---	---	---

DAF

F 1300						
F 1300 F 1300 DF			 3400 124 901  3482 060 132  1861 777 037  3151 199 001	350 10 MF350 350GTD KZIS-3	Getr. / GBox: ZF 6S-36 Nabenprofil / Hub Profile: 1 1/2"-10N	(46)
			 3482 008 034	310 MF310		
FA 1300			 3482 008 034	310 MF310	Getr. / GBox: DF615	
			 3482 002 234	350 GMF350X		
			 1878 001 071	350 10 350GTZ		
			 3400 124 901  3482 060 132  1861 777 037  3151 199 001	350 10 MF350 350GTD KZIS-3	Getr. / GBox: ZF 6S-36 Nabenprofil / Hub Profile: 1 1/2"-10N	(46)
FA 1300 DF FA 1300 DNT,FA 1300 NT FA 1300 DNTD,FA 1300 NB FA 1300 DT FA 1305 DT FA 1300 DT-B	07.78 - 10.88 12.86 - 12.92 12.86 - 12.92 07.78 - 02.90 07.78 - 02.90 07.78 - 02.90	DNT620, DT615, NT116, DNTD620, DF615, NT133	 3400 124 901  3482 060 132  1861 777 037  3151 199 001	350 10 MF350 350GTD KZIS-3	Getr. / GBox: ZF S6-36 Nabenprofil / Hub Profile: 1 1/2"-10N	(46)
F 1400						
F 1400 DF		D615	 1882 137 307 #	310 GF310		
FA 1400 DD	02.72 - 12.81	DD575	 3400 124 901  3482 060 132  1861 777 037  3151 199 001	350 10 MF350 350GTD KZIS-3	Nabenprofil / Hub Profile: 1 1/2"-10N	(46)
F 1500 07.78 -						
F 1500 DF			 3400 124 901  3482 060 132  1861 777 037  3151 199 001	350 10 MF350 350GTD KZIS-3	Getr. / GBox: ZF 6S-36 Nabenprofil / Hub Profile: 1 1/2"-10N	(46)
			 3482 008 034	310 MF310		
FA 1500			 3482 008 034	310 MF310	Getr. / GBox: DF615	
			 3482 002 234	350 GMF350X		
			 1878 001 071	350 10 350GTZ		
FA 1500 DF,FD 1500 DF FA 1500 DT,FD 1500 DT FT 1500 DT	07.78 - 08.91 07.78 - 08.91	DT615, DF615	 3400 124 901  3482 060 132  1861 777 037  3151 199 001	350 10 MF350 350GTD KZIS-3	Getr. / GBox: ZF S6-36 Nabenprofil / Hub Profile: 1 1/2"-10N	(46)
F 1600						
F 1600			 1878 001 071	350 10 350GTZ	Getr. / GBox: ZF 6S-36 nur als Ersatz für angegebene OE-Nr. / only for the listed OE-Numbers	(100)
			 1861 777 043	350 10 350GTD	Getr. / GBox: ZF 6S-36 nur als Ersatz für angegebene OE-Nr. / only for the listed OE-Numbers	(100)
			 3151 199 001	KZIS-3	Getr. / GBox: ZF 6S-36	
		DH825	 1882 110 542	350 GF350	Getr. / GBox: S 8-45-2	
			 1878 001 070	350 10 350GTZ	Getr. / GBox: S 8-45-2	
F 1600 DT FA 1600 DF FA 1600 DF 420 FA 1605 DF FAS 1600 DF FT 1600 DF	01.70 - 08.91 01.70 - 08.91	DF615	 1878 001 071	350 10 350GTZ	Getr. / GBox: ZF 6S-36 nur als Ersatz für angegebene OE-Nr. / only for the listed OE-Numbers	(100)
			 1861 777 043	350 10 350GTD	Getr. / GBox: ZF 6S-36 nur als Ersatz für angegebene OE-Nr. / only for the listed OE-Numbers	(100)
			 3151 199 001	KZIS-3	Getr. / GBox: ZF 6S-36	
			 1882 137 307 #	310 GF310		



		CODE				
--	--	------	--	--	--	--

DAF



















F 1600						
FA 1600 DT	01.73-08.91	DT615		1878 001 071	350 10 350GTZ	Getr. / GBox: ZF S6-36
FA 1600 DT	01.73-08.91			1861 777 043	350 10 350GTD	Getr. / GBox: ZF S6-36
FGG 1600 DT, FGG 1621 DT	01.73-08.91			3151 199 001	KZIS-3	Getr. / GBox: ZF S6-36
FT 1600 DT	01.73-08.91			1878 001 071	350 10 350GTZ	Getr. / GBox: ZF S6-36
FA 1600 DTD				1861 777 043	350 10 350GTD	Getr. / GBox: ZF 6S-36 nur als Ersatz für angegebene OE-Nr. / only for the listed OE-Numbers (100)
FAS 1600 DTD				1878 001 071	350 10 350GTZ	Getr. / GBox: ZF 6S-36 nur als Ersatz für angegebene OE-Nr. / only for the listed OE-Numbers (100)
FH 1600 DTD				3151 199 001	KZIS-3	Getr. / GBox: ZF 6S-36
FM 1600 DF				1882 110 542	350 GF350	
FT 1600 DTD				1878 001 071	350 10 350GTZ	
FA 1605 DT				1878 001 071	350 10 350GTZ	Getr. / GBox: ZF 6S-36 nur als Ersatz für angegebene OE-Nr. / only for the listed OE-Numbers (100)
FA 1605 DTD				1861 777 043	350 10 350GTD	Getr. / GBox: ZF 6S-36 nur als Ersatz für angegebene OE-Nr. / only for the listed OE-Numbers (100)
				3151 199 001	KZIS-3	Getr. / GBox: ZF 6S-36
				1882 110 542	350 GF350	Getr. / GBox: AK/S 5-35-2
				1878 001 071	350 10 350GTZ	Getr. / GBox: AK/S 5-35-2
		DH825		1882 110 542	350 GF350	Getr. / GBox: S 8-45-2
				1878 001 070	350 10 350GTZ	Getr. / GBox: S 8-45-2
F 1700						
FA 1700 DNS	01.88-02.95	DNT620,		3400 124 801	350 10	Getr. / GBox: ZF S6-36
FA 1700 DNT, FA 1700 NT	12.86-02.95	DNS620,		3482 060 132	MF350	Nabenprofil / Hub Profile: 1 3/4"-10N (46)
FA 1700 DNTD, FA 1700 NB, FD 1700 DNTD, FD 1700 NB	12.86-02.95	NT116,		1861 777 043	350GTD	
FAG 1700 DNT, FAG 1700 NT	12.86-02.95	DNTD620,		3151 000 395	KZIS-3	
FAG 1700 DNTD, FAG 1700 NB	12.86-02.95	NT133		3400 124 901	350 10	Getr. / GBox: ZF S6-36
				3482 060 132	MF350	Nabenprofil / Hub Profile: 1 1/2"-10N (46)
				1861 777 037	350GTD	
				3151 199 001	KZIS-3	
F 1800						
FAV 1800 DT	01.70-08.91	DT615		3482 002 234	350 GMF350X	Getr. / GBox: ZF S5-36
				1861 777 037	350 10 350GTD	Getr. / GBox: ZF S5-36
				3163 030 100	KZI-3	Getr. / GBox: ZF S5-36
				1882 110 542	350 GF350	
				1878 001 071	350 10 350GTZ	
F 1900						
FA 1900 DNS	12.86-09.93	NS156,		3400 124 901	350 10	Nabenprofil / Hub Profile: 1 1/2"-10N (46)
FA 1900 DNS, FA 1900 NS	12.86-09.93	DNS620,		3482 060 132	MF350	
FA 1900 DNT, FA 1900 NT	12.86-09.93	DNT620,		1861 777 037	350GTD	
FA 1900 DNT, FA 1900 NT	12.86-09.93	NT133		3151 000 395	KZIS-3	
FA 1900 DNT, FD 1900 DNT, FD 1900 NT	12.86-09.93			3400 124 801	350 10	Nabenprofil / Hub Profile: 1 3/4"-10N (46)
				3482 060 132	MF350	
				1861 777 043	350GTD	
				3151 000 395	KZIS-4	
FAV 1900 DNT, FAV 1900 NT	12.86-09.93					
FT 1900 DNS, FT 1900 NS	12.86-09.93					
F 2000						
F 2000		DH825		1882 110 542	350 GF350	Getr. / GBox: S 8-45-2
F 2000 DH				1878 001 070	350 10 350GTZ	Getr. / GBox: S 8-45-2

DAF

F 2000























F 2000 DHB		DH/DU/DHB825		1878 000 105	380 10 380GTZ		
FA 2000 DHB	01.70 - 12.79						
FAS 2000 DHB	01.70 - 12.79						
FAT 2000 DHB	01.70 - 12.79						
FM 2000 DHB	01.70 - 12.79						
FT 2000 DHB	01.70 - 12.79						
FT 2005 DHB	01.70 - 12.79						
FA 2000 DH	01.70 - 12.79	DH825		1882 110 542	350 GF350	Getr. / GBox: S 8-45-2	
FAS 2000 DH	01.70 - 12.79						
FAT 2000 DH	01.70 - 12.79			1878 001 070	350 10 350GTZ	Getr. / GBox: S 8-45-2	
FM 2000 DH	01.70 - 12.79						
FT 2000 DH	01.70 - 12.79						

F 2100

F 2100		DH, DHR, DHT825, DF615		3482 008 034	310 MF310	Je nach Kundenwunsch mit unterschiedlicher Kupplung / Equipped with different clutch according to customer requirement	(33)
		DH, DHR, DHT825		3482 002 234	350 GMF350X	Je nach Kundenwunsch mit unterschiedlicher Kupplung / Equipped with different clutch according to customer requirement	(33)
				1878 001 071	350 10 350GTZ		
				3163 026 100	KZI-4	Kugellager / Ball Bearing	(36)
				3482 017 035	380 GMF380	Je nach Kundenwunsch mit unterschiedlicher Kupplung / Equipped with different clutch according to customer requirement	(33)
				1878 000 105	380 10 380GTZ		
				3151 000 395	KZIS-4		
		3400 124 701  3482 017 034  1878 000 105  3151 000 395	380 10 GMF380 380GTZ KZIS-4	Getr. / GBox: ZF S6-90 Getr. / GBox: ZF 9/16S-109			
F 2105		DH, DHR, DHT825		3482 002 234	350 GMF350X	Je nach Kundenwunsch mit unterschiedlicher Kupplung / Equipped with different clutch according to customer requirement	(33)
				1878 001 071	350 10 350GTZ		
				3163 026 100	KZI-4	Kugellager / Ball Bearing	(36)
				3482 017 035	380 GMF380	Je nach Kundenwunsch mit unterschiedlicher Kupplung / Equipped with different clutch according to customer requirement	(33)
				3400 124 701  3482 017 034  1878 000 105  3151 000 395	380 10 GMF380 380GTZ KZIS-4	Getr. / GBox: ZF S6-90 Getr. / GBox: ZF 9/16S-109	































		CODE				
--	--	------	--	---	---	---

DAF

F 2100						
FA 2100 DF,FA 2105 DF	07.78 - 09.86	DHR825,		3400 124 701	380 10	Getr. / GBox: ZF 9S/16S-109, S6-90
FA 2105 DHR,FA 2105 DHTD	07.78 - 09.86	DHTD825,		 3482 017 034	GMF380	
FA 2105 DHT	07.81 - 09.86	DHT825,		 1878 000 105	380GTZ	
FA 2105 DHT	06.86 - 08.91	DH825,		 3151 000 395	KZIS-4	
FA 2105 DHTD	06.86 - 08.91	DF615				
FAG 2100 DH,FAG 2105 DH	07.78 - 09.86					
FAG 2100 DHR,FAG 2105 DHR,FAG 2100 DHTD	07.78 - 09.86					
FAS 2100 DHR,FAS 2103 DHR,FAS 2105 DHR,FAS 2103 DHTD	07.78 - 09.86					
FAS 2103 DH	07.78 - 09.86					
FAS 2103 DH,FAS 2105 DH	06.86 - 08.91					
FAS 2103 DHT	07.81 - 09.86					
FAS 2103 DHT	07.81 - 09.86					
FAS 2103 DHTD	06.86 - 08.91					
FT 2100 DHR	07.78 - 08.91					
FT 2105 DHT	07.81 - 09.86					
FT 2105 DHT	07.81 - 09.86					
FT 2105 DHTD	07.81 - 09.86					
FT 2105 DHTD	06.86 - 08.91					
FA 2100 DH	07.78 - 09.86	DH825		3482 011 331 ●#	360	Getr. / GBox: S 6-36+GV 36
FA 2105 DH	06.86 - 08.91			3482 000 953 ●	350	Getr. / GBox: S 6-36+GV 36
FT 2100 DH,FT 2105 DH	07.78 - 08.91				GMF350X	
				1878 001 070	350 10	Getr. / GBox: S 6-36+GV 36
					350GTZ	
				3151 000 515	350 10	Getr. / GBox: S 6-36+GV 36
					KZIS-4	
				3400 124 701	380 10	Getr. / GBox: ZF S6-90
				 3482 017 034	GMF380	Getr. / GBox: ZF 9/16S-109
				 1878 000 105	380GTZ	
				 3151 000 395	KZIS-4	
FA 2100 DNS				3400 124 701	380 10	Getr. / GBox: ZF S6-90
				 3482 017 034	GMF380	Getr. / GBox: ZF 9/16S-109
				 1878 000 105	380GTZ	
				 3151 000 395	KZIS-4	
				3400 124 801	350 10	Getr. / GBox: S 6-65+GV 80
				 3482 060 132	MF350	Nabenprofil / Hub Profile: 1 3/4"-10N
				 1861 777 043	350GTD	
				 3151 000 395	KZIS-4	
						(46)
F 2200						
F 2200 DT		DH825		1882 110 542	350	Getr. / GBox: S 8-45-2
					GF350	
				1878 001 070	350 10	Getr. / GBox: S 8-45-2
					350GTZ	
F 2205 DHB		DH/DU/DHB825		1878 000 105	380 10	
FA 2200 DU	01.71 - 11.80				380GTZ	
FAD 2205 DU	01.71 - 11.80					
FAS 2200 DU						
FAS 2205 DU	01.71 - 11.80					
FAT 2205 DU	01.71 - 11.80					
FAZ 2205 DU	01.71 - 11.80					
FT 2200 DU	01.71 - 11.80					































		CODE		 Parameter		
--	--	------	--	---	---	---

DAF





















F 2300		09.63 - 10.93				
F 2300		DH825/DHU825	 3482 002 234	350 GMF350X	Je nach Kundenwunsch mit unterschiedlicher Kupplung / Equipped with different clutch according to customer requirement	(33)
			 1878 001 070	350 10 350GTZ		
			 3163 026 100	KZI-4	Kugellager / Ball Bearing	(36)
			 1878 000 105	380 10 380GTZ		
			 3482 017 035	380 GMF380	Je nach Kundenwunsch mit unterschiedlicher Kupplung / Equipped with different clutch according to customer requirement	(33)
			 1878 000 105	380 10 380GTZ		
			 3151 000 395	KZIS-4		
		DHT825	 3151 111 032	KZI-6	ohne Schmierrohranschluß / without lubricating pipe connection	(103)
			 3400 124 701  3482 017 034  1878 000 105  3151 000 395	380 10 GMF380 380GTZ KZIS-4	Getr. / GBox: ZF S6-90 Getr. / GBox: ZF 9/16S-109	
F 2305		DH825/DHU825	 3482 002 234	350 GMF350X	Je nach Kundenwunsch mit unterschiedlicher Kupplung / Equipped with different clutch according to customer requirement	(33)
			 1878 001 070	350 10 350GTZ		
			 3163 026 100	KZI-4	Kugellager / Ball Bearing	(36)
			 3482 017 035	380 GMF380	Je nach Kundenwunsch mit unterschiedlicher Kupplung / Equipped with different clutch according to customer requirement	(33)
			 1878 000 105	380 10 380GTZ		
			 3151 000 395	KZIS-4		
			 3400 124 701  3482 017 034  1878 000 105  3151 000 395	380 10 GMF380 380GTZ KZIS-4	Getr. / GBox: ZF S6-90 Getr. / GBox: ZF 9/16S-109	
FA 2300 DHR	07.78 - 12.81	HT825, DHR825, DHT825, DHTD825, DHU825, DH825	 3400 124 701  3482 017 034  1878 000 105  3151 000 395	380 10 GMF380 380GTZ KZIS-4	Getr. / GBox: ZF 9S/16S-109, S6-90	
FA 2300 DHU	07.78 - 12.81					
FA 2300 HT	01.90 - 10.93					
FAB 2305 DHT,FAG 2305	07.78 - 09.86					
DHT,FAS 2300 DHU,FAS 2303						
DHU,FAS 2305						
FAG 2300 DHT,FAG 2305 DHT	11.81 - 09.86					
FAG 2300 DHT,FAG 2305 DHT	09.86 - 08.91					
FAG 2300 DHTD,FAG 2305	06.86 - 08.91					
DHTD						
FAG 2300 HT,FAR 2300 HT	01.90 - 10.93					
FAG 2305 DH	07.78 - 12.81					
FAS 2300 DHR,FAS 2305 DHR	07.78 - 12.81					
FAT 2300 HT	01.90 - 10.93					
FAT 2305 DH	07.78 - 12.81					
FAT 2305 DHR	07.78 - 12.81					
FAT 2305 DHU,FAT 2335 DHT	07.78 - 09.86					
FAT 2335 DHT	06.86 - 08.91					
FMB 2305 DHU	07.78 - 12.83					
FMT 2300 HT	01.90 - 10.93					
FMT 2305 DHR	07.78 - 12.81					
FMT 2305 DHU,FMT 2335 DHT	07.78 - 09.86					
FMT 2335 DHT	06.86 - 08.91					
FT 2300 DHU,FT 2305 DHU	07.78 - 12.83					
FT 2300 HT	01.90 - 10.93					
FAV 2300 HT	01.90 - 10.93	HT825	 3400 124 701  3482 017 034  1878 000 105  3151 000 395	380 10 GMF380 380GTZ KZIS-4		

		CODE				
--	--	------	--	---	---	---





DAF

F 2500						
FA 2500 DHS		DHS825		3482 017 035	380	Getr. / GBox: S 6-90+GV 90
FAD 2535 DHS	02.82 - 09.86				GMF380	
FAD 2535 DHS	06.86 - 08.91			3151 000 515	KZIS-4	Getr. / GBox: S 6-90+GV 90
FAD 2535 DHS	02.82 - 09.86					
FAD 2535 DHS	06.86 - 08.91					
FAS 2500 DHS						
FT 2500 DHS	02.82 - 09.86					
F 2500 DHS						
FA 2500 DHS	02.82 - 08.86	DHS825		3482 017 035	380	
FA 2505 DHS	06.86 - 08.91				GMF380	
FAG 2500 DHS, FAG 2505 DHS, FAS 2503 DHS	06.86 - 08.91			3151 000 515	KZIS-4	
FAG 2505 DHS, FAS 2503 DHS	02.82 - 09.86					
FAT 2525 DHS	02.82 - 09.86					
FAT 2525 DHS	06.86 - 08.91					
FAT 2525 DHS, FAT 2535 DHS	06.86 - 08.91					
FAT 2535 DHS	02.82 - 09.86					
FMD 2525 DHS	02.82 - 09.86					
FMD 2525 DHS, FMD 2535 DHS	06.86 - 08.91					
FMT 2525 DHS	02.82 - 09.86					
FMT 2525 DHS, FMT 2535 DHS	06.86 - 08.91					
FT 2505 DHS	06.86 - 08.91					
F 2600 09.62 - 12.73						
F 2600		DK/DKA1160		1878 001 138	420 10	
FAT 2600 DKA					420GTZ	
FTT 2606 DKA (Iran)				3151 000 515	KZIS-4	
FA 2600 DKB	02.72 - 12.73	DKB1160		3151 000 515	KZIS-4	
FAS 2600 DKB	02.72 - 12.73					
FT 2600 DKB	02.72 - 12.73					
FTS 2600 DKB						
FTT 2600 DKB	02.72 - 12.73					
F 2700 01.90 - 10.93						
F 2700				3400 124 701	380 10	Getr. / GBox: ZF 9/16S-109
				3482 017 034	GMF380	Getr. / GBox: ZF S6-90
				1878 000 105	380GTZ	
				3151 000 395	KZIS-4	
FA 2700 HS	01.90 - 10.93	HS825		3400 124 701	380 10	
FAB 2700 HS, FAG 2700 HS, FAR 2700 HS	01.90 - 10.93			3482 017 034	GMF380	
FAT 2700 HS	01.90 - 10.93			1878 000 105	380GTZ	
FMT 2700 HS	01.90 - 10.93			3151 000 395	KZIS-4	
FT 2700 HS	01.90 - 10.93					
F 2800 09.73 - 09.91						
F 2800		DKT/DKTD1160		3482 124 550	430	
F 2805				3482 006 036 ●#	420	
				3151 000 515	GTF420	
				3482 018 132 #	KZIS-4	
				3482 119 031	420	Getr. / GBox: ZF 16S-151/181/221
				1878 086 741	GMF420	
				3151 182 233	430	Getr. / GBox: ZF 16S-151/181/221
				3482 119 032	420 10	Getr. / GBox: ZF 16S-151/181/221
				1878 003 269	430WGTZ	
				3151 000 395	KZI-5	Getr. / GBox: ZF 16S-151/181/221
				3482 119 032	430	Getr. / GBox: ZF 16S-130
				1878 003 269	GMF430	
				3151 000 395	420 10	Getr. / GBox: ZF 16S-130
				3151 000 395	420GTZ	
				3151 000 395	KZIS-4	Getr. / GBox: ZF 16S-130

DAF

F 2800		09.73 - 09.91		
F 2800 ATi	DKXE1160ATi	 3400 125 701	430 10	
		 3482 119 031	GMF430	
	 1878 003 269	420GTZ		
	 3151 000 395	KZIS-4		
	 3482 018 132 ●#	420		
		GMF420		
	 3482 018 132 #	420	Getr. / GBox: ZF 16S-151/181/221	
		GMF420		
	 1878 086 741	420 10	Getr. / GBox: ZF 16S-151/181/221	
		430WGTZ		
 3151 182 233	KZI-5	Getr. / GBox: ZF 16S-151/181/221		
 3482 119 032	430	Getr. / GBox: ZF 16S-130		
	GMF430			
 1878 003 269	420 10	Getr. / GBox: ZF 16S-130		
	420GTZ			
 3151 000 395	KZIS-4	Getr. / GBox: ZF 16S-130		
F 2800 DKA/DKT	DKA1160	 3482 124 541	430	
			GMF430	
		 1882 330 032 ●#	420	
		GF420		
	 3151 000 515	KZIS-4		
	 3482 018 132 #	420	Getr. / GBox: ZF 16S-151/181/221	
		GMF420		
	 3482 119 031	430	Getr. / GBox: ZF 16S-151/181/221	
		GMF430		
	 1878 086 741	420 10	Getr. / GBox: ZF 16S-151/181/221	
		430WGTZ		
	 3151 182 233	KZI-5	Getr. / GBox: ZF 16S-151/181/221	
	 3482 119 032	430	Getr. / GBox: ZF 16S-130	
	GMF430			
 1878 003 269	420 10	Getr. / GBox: ZF 16S-130		
	420GTZ			
 3151 000 395	KZIS-4	Getr. / GBox: ZF 16S-130		





















DAF

F 2800		09.73 - 09.91			
FA 2800 DKA	01.74-08.80	DKA1160,	 3400 124 601	430 10	Getr. / GBox: ZF 16S-151/181/221
FA 2800 DKS	01.74-09.86	DKXE1160,	 3482 119 031	GMF430	
FA 2800 DKT	01.74-11.80	DKV1160,	 1878 086 741	430WGTZ	
FA 2800 DKTD	01.74-09.86	DKT1160,	 3151 000 395	KZIS-4	
FA 2800 DKTD	06.86-09.91	DKS1160,			
FA 2800 DKTD	06.86-09.91	DKTD1160,			
FA 2805 DKSE,FA 2800 DKV,FA 2800 DKXE	05.83-09.91	DKS1160E			
FAB 2805 DKS,FAR 2800 DKS,FAS 2800 DKS	01.74-09.86				
FAB 2805 DKTD,FAS 2800 DKTD	01.74-09.86				
FAC 2803 DKS	01.74-09.86				
FAC 2803 DKSE	01.80-07.90				
FAC 2803 DKTD	01.74-09.91				
FAD 2805 DKS	01.74-09.86				
FAD 2805 DKTD	01.74-06.86				
FAD 2825 DKTD	06.86-09.91				
FAD 2825 DKTD	01.74-09.91				
FAD 2825 DKV	05.83-09.91				
FAG 2800 DKV,FAR 2804 DKXE,FAS 2803 DKXE,DKSE,DKV	05.83-09.91				
FAR 2804 DKSE,FAS 2800 DKT	01.80-09.86				
FAS 2800 DKA	01.74-11.80				
FAS 2803 DKS	06.86-09.91				
FAS 2803 DKTD	06.86-09.91				
FAT 2800 DKA	01.74-11.80				
FAT 2800 DKS	01.74-09.86				
FAT 2800 DKT	01.74-11.80				
FAT 2800 DKTD	01.74-09.86				
FAT 2805 DKS,FAT 2825 DKS	06.86-09.91				
FAT 2805 DKTD,FAT 2825 DKTD	06.86-09.91				
FMD 2805 DKTD,FMD 2825 DKTD	01.74-09.86				
FMD 2805 DKTD,FMD 2825 DKTD	06.86-09.91				
FMD 2825 DKV	05.83-09.91				
FT 2800 DKA	01.74-11.80				
FT 2800 DKT	01.74-11.80				
FT 2800 DKTD	01.74-09.86				
FT 2805 DKTD	06.86-09.91				
FTS 2800 DKA	01.74-11.80				
FTS 2800 DKS	01.74-09.86				
FTS 2800 DKT	01.74-11.80				
FTS 2800 DKTD	01.74-09.86				
FTS 2803 DKS	06.86-09.91				
FTS 2803 DKTD	06.86-09.91				
FTT 2800 DKA	01.74-11.80				
FTT 2800 DKS	01.74-09.86				
FTT 2800 DKT	01.74-11.80				
FTT 2800 DKTD	01.74-09.86				
FTT 2805 DKS,FTT 2815 DKS,FTT2825 DKS	06.86-09.91				
FTT 2805 DKTD	06.86-09.91				





		CODE				
--	--	------	--	---	---	---

DAF





F 2800 09.73 - 09.91

FA 2800 DKSE FL 2805 DKS FT 2800 DKTD FTT 2816 DKS	01.80 - 09.86	-SE1160, DK, -S, -TL, -TD, DKS1160E	 3400 700 305	430 10	Getr. / GBox: ZF 16S-151/181/221	
			 3482 118 031	GMF430		
			 1878 002 706	420GTZ		
			 3151 000 515	KZIS-4		
			 3482 119 031	430		Getr. / GBox: ZF 16S-151/181/221
			3482 018 132 #	420		Getr. / GBox: ZF 16S-151/181/221
				GMF420		
			 1878 086 741	420 10		Getr. / GBox: ZF 16S-151/181/221
	430WGTZ					
 3151 182 233	KZI-5	Getr. / GBox: ZF 16S-151/181/221				
 3482 119 032	430	Getr. / GBox: ZF 16S-130				
	GMF430					
 1878 003 269	420 10	Getr. / GBox: ZF 16S-130				
	420GTZ					
 3151 000 395	KZIS-4	Getr. / GBox: ZF 16S-130				
FT 2800 DKS FT 2800 DKSE,FT 2800DKXE,FT 2800 DKV FT 2805 DKS	01.74 - 09.86 01.80 - 09.91 06.86 - 09.91	DKXE1160, DKV1160, DKS1160, DKS1160E	 3400 700 305	430 10	Getr. / GBox: ZF 16S-151/181/221	
			 3482 118 031	GMF430		
			 1878 002 706	420GTZ		
			 3151 000 515	KZIS-4		
			 3482 018 132 #	420		Getr. / GBox: ZF 16S-151/181/221
			3482 119 031	430		Getr. / GBox: ZF 16S-151/181/221
				GMF430		
			 1878 086 741	420 10		Getr. / GBox: ZF 16S-151/181/221
	430WGTZ					
 3151 182 233	KZI-5	Getr. / GBox: ZF 16S-151/181/221				
 3482 119 032	430	Getr. / GBox: ZF 16S-130				
	GMF430					
 1878 003 269	420 10	Getr. / GBox: ZF 16S-130				
	420GTZ					
 3151 000 395	KZIS-4	Getr. / GBox: ZF 16S-130				

F 2900 01.90 - 10.93

FA 2900 KV FAD 2900 KV FAG 2900 KV,FAR 2900 KV,FAS 2900 KV FMD 2900 KV FT 2900 KV	01.90 - 10.93	KV1160	 3400 124 601	430 10	Getr. / GBox: ZF 16S-151/181/221
			 3482 119 031	GMF430	
			 1878 086 741	430WGTZ	
			 3151 000 395	KZIS-4	

























F 3200 01.90 - 10.93

FA 3200 KS FAB 3200 KS,FAR 3200 KS,FAS 3200 KS FAD 3200 KS FAT 3200 KV FMD 3200 KS FT 3200 KS	01.90 - 10.93	KS1160	 3400 124 601	430 10	Getr. / GBox: ZF 16S-151/181/221
			 3482 119 031	GMF430	
			 1878 086 741	430WGTZ	
			 3151 000 395	KZIS-4	

		CODE				
--	--	------	--	---	---	---

DAF









F 3300 06.81 - 09.91

F 3300		DKX1160	 3482 118 031	430 GMF430			
			 1878 002 706	420 10 420GTZ			
			 3151 000 515	KZIS-4			
				DKX1160	 3482 018 132 #	420 GMF420	Getr. / GBox: ZF 16S-151/181/221
					3482 119 031	430 GMF430	Getr. / GBox: ZF 16S-151/181/221
				 1878 086 741	420 10 430WGTZ	Getr. / GBox: ZF 16S-151/181/221	
				 3151 182 233	KZI-5	Getr. / GBox: ZF 16S-151/181/221	
				 3482 119 032	430 GMF430	Getr. / GBox: ZF 16S-130	
				 1878 003 269	420 10 420GTZ	Getr. / GBox: ZF 16S-130	
				 3151 000 395	KZIS-4	Getr. / GBox: ZF 16S-130	
F 3300 ATi		DKX1160ATi	 3400 125 701	430 10 GMF430			
			 3482 119 031	420GTZ			
		 1878 003 269	KZIS-4				
		 3151 000 395					
		 3482 018 132 ●#	420 GMF420				
				DKX1160ATi	 3482 018 132 #	420 GMF420	Getr. / GBox: ZF 16S-151/181/221
					 1878 086 741	420 10 430WGTZ	Getr. / GBox: ZF 16S-151/181/221
					 3151 182 233	KZI-5	Getr. / GBox: ZF 16S-151/181/221
					 3482 119 032	430 GMF430	Getr. / GBox: ZF 16S-130
					 1878 003 269	420 10 420GTZ	Getr. / GBox: ZF 16S-130
 3151 000 395	KZIS-4				Getr. / GBox: ZF 16S-130		
FA 3300 DKX,FA 3305 DKX	06.81 - 09.86	DKX1160, DKX1160ATi	 3400 124 601	430 10 GMF430	Getr. / GBox: ZF 16S-151/181/221		
FA 3300 DKX,FA 3305 DKX	06.85 - 09.91					 3482 119 031	420GTZ
FAB 3305 DKX,FAG 3300	06.81 - 09.86					 1878 086 741	430WGTZ
DKX,FAR 3300 DKX,FAS 3303 DKX						 3151 000 395	KZIS-4
FAC 3303 DKX	06.81 - 09.86						
FAC 3303 DKX	06.85 - 09.91						
FAD 3325 DKX	06.81 - 09.86						
FAD 3325 DKX	06.85 - 09.91						
FAG 3300 DKX,FAR 3304 DKX,FAS 3303 DKX	06.85 - 09.91						
FAT 3325 DKX	06.81 - 09.86						
FAT 3325 DKX	06.85 - 09.91						
FT 3305 DKX	06.81 - 09.86						
FT 3305 DKX	06.85 - 09.91						
FTG 3300 DKX,FTS 3300 DKX	06.81 - 09.86						
FTG 3300 DKX,FTS 3303 DKX	06.85 - 09.91						
FTT 3325 DKX	06.81 - 09.86						
FTT 3325 DKX	06.85 - 09.91						



		CODE				
--	--	------	--	---	---	---

DAF











F 3600 06.85 - 09.91

F 3600		DKZ1160ATi	 3400 124 601 ⊗ 3482 119 031 ⊗ 1878 086 741 ⊙ 3151 000 395	430 10 GMF430 430WGTZ KZIS-4	
			 3482 018 132 ●#	420 GMF420	
		 3482 018 132 #	420 GMF420	Getr. / GBox: ZF 16S-151/181/221	
		 1878 086 741	420 10 430WGTZ	Getr. / GBox: ZF 16S-151/181/221	
		 3151 182 233	KZI-5	Getr. / GBox: ZF 16S-151/181/221	
		 3482 119 032	430 GMF430	Getr. / GBox: ZF 16S-130	
		 1878 003 269	420 10 420GTZ	Getr. / GBox: ZF 16S-130	
		 3151 000 395	KZIS-4	Getr. / GBox: ZF 16S-130	
FA 3605 DKZ FA 3605 DKZE FAC 3603 DKZ FAG 3600 DKZ,FAR 3604 DKZ,FAS 3603 DKZ FAR 3604 DKZE,FAS 3603 DKZE FT 3605 DKZ FT 3605 DKZE FTG 3600 DKZ,FTS 3603 DKZ FTT 3625 DKZ	06.85 - 09.91 06.85 - 09.91 06.85 - 09.91 06.85 - 09.91 06.85 - 09.91 06.85 - 09.91 06.85 - 09.91 06.85 - 09.91	DKZ1160ATI, DKZE1160	 3400 124 601 ⊗ 3482 119 031 ⊗ 1878 086 741 ⊙ 3151 000 395	430 10 GMF430 430WGTZ KZIS-4	Getr. / GBox: ZF 16S-151/181/221

N 2800

NAT 2826 DKS	01.81 - 09.91	DKS1160	 3482 118 031	430 GMF430	
			 1878 003 269	420 10 420GTZ	

N 3300

NAT 3326 DKX	01.81 - 09.91	DKX1160	 3482 118 031	430 GMF430	
			 1878 002 706	420 10 420GTZ	
			 3151 000 515	KZIS-4	
			 3482 018 132 #	420 GMF420	Getr. / GBox: ZF 16S-151/181/221
			 3482 119 031	430 GMF430	Getr. / GBox: ZF 16S-151/181/221
			 1878 086 741	420 10 430WGTZ	Getr. / GBox: ZF 16S-151/181/221
			 3151 182 233	KZI-5	Getr. / GBox: ZF 16S-151/181/221
			 3482 119 032	430 GMF430	Getr. / GBox: ZF 16S-130
			 1878 003 269	420 10 420GTZ	Getr. / GBox: ZF 16S-130
			 3151 000 395	KZIS-4	Getr. / GBox: ZF 16S-130























SHERPA / FREIGHT ROVER

1,7	01.85 -		 3082 956 001	242 MF242	->Chass. 271675
			 1862 788 001	242 23 242TP	->Chass. 271675
			 1863 805 001	GR.1	->Chass. 271675
1,7	- 03.89		 1850 480 049	240 M240	Chass. 271676->
			 1862 788 001	242 23 242TP	Chass. 271676->
			 1863 805 001	GR.1	Chass. 271676->















		CODE				
--	--	------	--	---	---	---

DAF



SHERPA / FREIGHT ROVER

1,8 D	01.85 - 09.86		 3082 956 001	242 MF242	
			 1862 788 001	242 23 242TP	
			 1863 805 001	GR.1	
2,0	01.83 - 04.86		 3082 956 001 	242 MF242	
			 1862 788 001 	242 23 242TP	
			 1863 805 001 	GR.1	
2,0 2,0 D	05.86 - 03.89 09.86 - 03.89		 1850 480 049 	240 M240	
			 1862 788 001 	242 23 242TP	
			 1863 805 001 	GR.1	
2,5 D	01.83 - 03.89		 3000 950 701	242 23	
			 3082 973 001	MF242	
			 1862 788 001	242TP	
2,5 D 2,5 TD	04.89 - 04.89 -	Peugeot	 3000 840 101	235 10	
			 3082 737 001	MFZ235	
			 1862 642 001	235CP	
			 3151 600 548	KZAS-1	

T - Serie

T 15/2 DF T 1600 DF		DF615	 1882 137 307 #	310 GF310	
T 18 DM TB 160/163 DS			 1882 110 542	350 GF350	Getr. / GBox: AK/S 5-35-2
			 1878 001 071	350 10 350GTZ	Getr. / GBox: AK/S 5-35-2
T 500 T 505			 3482 060 132	350 MF350	
			 1861 777 037	350 10 350GTD	
T 575			 3482 083 113	430 MFZ430	
			 1878 002 878	420 10 420GTZ	
T 2200 DKD		DKTL615	 1878 001 138	420 10 420GTZ	
			 3151 000 515	KZIS-4	
T 2400 DK TE 2400 DK		DK/DKA1160	 1878 001 138	420 10 420GTZ	
			 3151 000 515	KZIS-4	
TT 1303 DH		DH825	 3482 011 331 ●#	360 GMF360	Getr. / GBox: 4-WG 181
			 3482 000 953 ●	350 GMF350X	Getr. / GBox: 4-WG 181
			 1878 001 070	350 10 350GTZ	Getr. / GBox: 4-WG 181
			 3151 000 515	KZIS-4	Getr. / GBox: 4-WG 181











V

V 1600 DD V 1700 DF V 1700 DSD			 1882 110 542	350 GF350	Getr. / GBox: AK/S 5-35-2
			 1878 001 071	350 10 350GTZ	Getr. / GBox: AK/S 5-35-2
V 2400 DK VE 2400 DK		DK/DKA1160	 1878 001 138	420 10 420GTZ	
			 3151 000 515	KZIS-4	





		CODE				
--	--	------	--	---	---	---

DAF

LF 45 01.01 -

45.170		BE123C	 3400 700 353 # ⊗ 3482 000 419 ⊗ 1878 079 331 ⊙ 3151 000 395	362 10 MF362 362WGTZ KZIS-4	Getr. / GBox: ZF 5S-42 Länderausführung: Groß Britannien / Country Version: Great Britain	(40)					
FA 45.140	05.06-	FR118S1, FR103S1	 3400 700 398 ⊗ 3482 000 859 ⊗ 1878 005 601 ⊙ 3151 000 397	362 10 MF362 362WGTZ KZIS-4	Getr. / GBox: ZF 5S-42 Abgasnorm: Euro 5 / Exhaust Emission Norm: Euro 5	(3)					
FA 45.140	05.06-										
FA 45.160	05.06-		3400 700 375 ⊗ 3482 000 419 ⊗ 1878 004 100 ⊙ 3151 000 651	362 10 MF362 362WGTZ KZIS-4							
FA 45.160	05.06-										
FA 45.150	01.01-						BE110C, BE123C, CE162C, CE136C	 3400 700 307 ⊗ 3482 000 419 ⊗ 1878 079 331 ⊙ 3151 000 397	362 10 MF362 362WGTZ KZIS-4	Getr. / GBox: ZF 5S-42	
FA 45.150	01.01-										
FA 45.170	01.01-	 3400 700 308 ⊗ 3482 123 839 ⊗ 1878 000 036 ⊙ 3151 000 395	395 10 MF395 395WGTZ KZIS-4	Getr. / GBox: ZF 6S-850							
FA 45.170	01.01-										
FA 45.180	01.01-										
FA 45.180	01.01-										
FA 45.180	01.01-										
FA 45.220	01.01-										
FA 45.220	01.01-										
FA 45.220	01.01-										
FA 45.180	05.06-					FR136S1	 3400 700 375 ⊗ 3482 000 419 ⊗ 1878 004 100 ⊙ 3151 000 651	362 10 MF362 362WGTZ KZIS-4			
FA 45.180	05.06-										
FA 45.180	05.06-										
FA 45.180	05.06-										
FA 45.220	05.06-	GR165S1, GR184S1	 3400 700 523 ■	395 10	XTend Getr. / GBox: ZF Nabenprofil / Hub Profile: 38,2x44,5-10N Nur zusammen verbauen / Only install together	(46) (51)					
FA 45.220	05.06-										
FA 45.220	05.06-		 3400 700 376 ⊗ 3482 000 474 ⊗ 1878 003 332 ⊙ 3151 000 651	395 10 MF395 395WGTZ KZIS-4	Getr. / GBox: ZF						
FA 45.250	03.06-										
FA 45.250	03.06-										
			 3400 700 473 ⊗ 3482 000 474 ⊗ 1878 005 599 ⊙ 3151 000 651	395 10 MF395 395WGTZ KZIS-4	Getr. / GBox: ZF 6S/800, 6S/1000 Abgasnorm: Euro 5 / Exhaust Emission Norm: Euro 5	(3)					
			 3400 700 524 ■	395 10	XTend Getr. / GBox: Eaton Nabenprofil / Hub Profile: 38,2x44,5-10N Nur zusammen verbauen / Only install together	(46) (51)					
			 3400 700 476 ⊗ 3482 000 474 ⊗ 1878 005 599 ⊙ 3151 000 395	395 10 MF395 395WGTZ KZIS-4	Getr. / GBox: Eaton Abgasnorm: Euro 5 / Exhaust Emission Norm: Euro 5	(3)					















LF 55 01.01 -

55.170		BE123C	 3400 700 353 # ⊗ 3482 000 419 ⊗ 1878 079 331 ⊙ 3151 000 395	362 10 MF362 362WGTZ KZIS-4	Getr. / GBox: ZF 6S-850 Länderausführung: Groß Britannien / Country Version: Great Britain	(40)	
FA 55.170	01.01-	BE123C, CE136C, CE162C	 3400 700 308 ⊗ 3482 123 839 ⊗ 1878 000 036 ⊙ 3151 000 395	395 10 MF395 395WGTZ KZIS-4	Getr. / GBox: ZF 6S850		
FA 55.180	01.01-						
FA 55.180	01.01-		 3400 700 527 ■	395 10	XTend Getr. / GBox: ZF 6S850 Nabenprofil / Hub Profile: 30,7x38,4-10N Nur zusammen verbauen / Only install together	(46) (51)	
FA 55.180	01.01-						
FA 55.220	01.01-			 3400 700 320 ⊗ 3482 123 839 ⊗ 1878 000 294 ⊙ 3151 000 395	395 10 MF395 395WGTZ KZIS-4	Getr. / GBox: Eaton 6309	
FA 55.220	01.01-						
FA 55.220	01.01-						
FT 55.180	01.01-						
FT 55.220	01.01-	 3400 700 519 ■	395 10	XTend Getr. / GBox: Eaton 6309 Nabenprofil / Hub Profile: 38,2x44,5-10N Nur zusammen verbauen / Only install together	(46) (51)		



		CODE				
--	--	------	--	---	---	---

DAF

LF 55 01.01 -

FA 55.180	05.06-	FR136S1	 3400 700 375 ⊗ 3482 000 419 ⊗ 1878 004 100 ⊙ 3151 000 651	362 10 MF362 362WGTZ KZIS-4		
FA 55.220	05.06-	GR165S1, GR184S1	 3400 700 473 ⊗ 3482 000 474 ⊗ 1878 005 599 ⊙ 3151 000 651	395 10 MF395 395WGTZ KZIS-4	Getr. / GBox: ZF 6S/800, 6S/1000 Abgasnorm: Euro 5 / Exhaust Emission Norm: Euro 5	(3)
FA 55.250	05.06-		 3400 700 476 ⊗ 3482 000 474 ⊗ 1878 005 599 ⊙ 3151 000 395	395 10 MF395 395WGTZ KZIS-4	Getr. / GBox: Eaton Abgasnorm: Euro 5 / Exhaust Emission Norm: Euro 5	(3)
FAN 55.220	05.06-		 3400 700 523 ■	395 10	XTend Nabenprofil / Hub Profile: 38,2x44,5-10N Je nach Kundenwunsch mit unterschiedlicher Kupplung / Equipped with different clutch according to customer requirement Nur zusammen verbauen / Only install together	(46) (33)
FT 55.220	05.06-		 3400 700 376 ⊗ 3482 000 474 ⊗ 1878 003 332 ⊙ 3151 000 651	395 10 MF395 395WGTZ KZIS-4	Je nach Kundenwunsch mit unterschiedlicher Kupplung / Equipped with different clutch according to customer requirement	(33)
FA 55.250	01.01-	CE184C	 3400 700 308 ⊗ 3482 123 839 ⊗ 1878 000 036 ⊙ 3151 000 395	395 10 MF395 395WGTZ KZIS-4	Getr. / GBox: ZF 6S850	
FA 55.250	01.01-		 3400 700 527 ●■	395 10	XTend Getr. / GBox: ZF 6S850 Nabenprofil / Hub Profile: 30,7x38,4-10N Nur zusammen verbauen / Only install together	(46) (51)
FT 55.250	01.01-		 3400 700 473 ⊗ 3482 000 474 ⊗ 1878 005 599 ⊙ 3151 000 651	395 10 MF395 395WGTZ KZIS-4	Getr. / GBox: ZF 6S/800, 6S/1000 Abgasnorm: Euro 5 / Exhaust Emission Norm: Euro 5	(3)
			 3400 700 476 ⊗ 3482 000 474 ⊗ 1878 005 599 ⊙ 3151 000 395	395 10 MF395 395WGTZ KZIS-4	Getr. / GBox: Eaton Abgasnorm: Euro 5 / Exhaust Emission Norm: Euro 5	(3)
			 3400 700 320 ⊗ 3482 123 839 ⊗ 1878 000 294 ⊙ 3151 000 395	395 10 MF395 395WGTZ KZIS-4	Getr. / GBox: Eaton 6309	
			 3400 700 519 ●■	395 10	XTend Getr. / GBox: Eaton 6309 Nabenprofil / Hub Profile: 38,2x44,5-10N Nur zusammen verbauen / Only install together	(46) (51)
FA 55.290	05.06-	GR210S1	 3400 700 523 ■	395 10	XTend Nabenprofil / Hub Profile: 38,2x44,5-10N Je nach Kundenwunsch mit unterschiedlicher Kupplung / Equipped with different clutch according to customer requirement Nur zusammen verbauen / Only install together	(46) (33)
FAN 55.290	05.06-		 3400 700 376 ⊗ 3482 000 474 ⊗ 1878 003 332 ⊙ 3151 000 651	395 10 MF395 395WGTZ KZIS-4	Je nach Kundenwunsch mit unterschiedlicher Kupplung / Equipped with different clutch according to customer requirement	(33)
FT 55.290	05.06-					
FAN 55.250	05.06-	CE184C	 3400 700 473 ⊗ 3482 000 474 ⊗ 1878 005 599 ⊙ 3151 000 651	395 10 MF395 395WGTZ KZIS-4	Getr. / GBox: ZF 6S/800, 6S/1000 Abgasnorm: Euro 5 / Exhaust Emission Norm: Euro 5	(3)
			 3400 700 476 ⊗ 3482 000 474 ⊗ 1878 005 599 ⊙ 3151 000 395	395 10 MF395 395WGTZ KZIS-4	Getr. / GBox: Eaton Abgasnorm: Euro 5 / Exhaust Emission Norm: Euro 5	(3)











LF 10.13 -

LF 150		PX-5112	 3400 700 465 ⊗ 3482 000 859 ⊗ 1878 005 601 ⊙ 3151 000 651	362 10 MF362 362WGTZ KZIS-4	Getr. / GBox: 6 S 700 Getr. / GBox: 6 AS 700 Abgasnorm: Euro 6 / Exhaust Emission Norm: Euro 6	(4)
			 3400 700 464 ⊗ 3482 000 859 ⊗ 1878 005 600 ⊙ 3151 000 651	362 10 MF362 362WGTZ KZIS-4	Getr. / GBox: 6 S 800 Getr. / GBox: 6 AS 800 Abgasnorm: Euro 6 / Exhaust Emission Norm: Euro 6	(4)
			 3400 700 603	350	Getr. / GBox: S5-42 Abgasnorm: Euro 6 / Exhaust Emission Norm: Euro 6	(4)







		CODE				
--	--	------	--	---	---	---

DAF

LF 10.13 -

LF 180		PX-5135	 3400 700 465 ⊗ 3482 000 859 ⊗ 1878 005 601 ⊙ 3151 000 651	362 10 MF362 362WGTZ KZIS-4	Getr. / GBox: 6 S 700 Getr. / GBox: 6 AS 700 Abgasnorm: Euro 6 / Exhaust Emission Norm: Euro 6 (4)
			 3400 700 464 ⊗ 3482 000 859 ⊗ 1878 005 600 ⊙ 3151 000 651	362 10 MF362 362WGTZ KZIS-4	Getr. / GBox: 6 S 800 Getr. / GBox: 6 AS 800 Abgasnorm: Euro 6 / Exhaust Emission Norm: Euro 6 (4)
			 3400 700 603 ⊗ 3482 001 166 ⊗ 1878 007 172 ⊙ 3151 000 397	350 MF350 350WGTZ KZIS-4	Getr. / GBox: S5-42 Abgasnorm: Euro 6 / Exhaust Emission Norm: Euro 6 (4)
LF 210		PX-5157	 3400 700 465 ⊗ 3482 000 859 ⊗ 1878 005 601 ⊙ 3151 000 651	362 10 MF362 362WGTZ KZIS-4	Getr. / GBox: 6 S 700 Getr. / GBox: 6 AS 700 Abgasnorm: Euro 6 / Exhaust Emission Norm: Euro 6 (4)
			 3400 700 464 ⊗ 3482 000 859 ⊗ 1878 005 600 ⊙ 3151 000 651	362 10 MF362 362WGTZ KZIS-4	Getr. / GBox: 6 S 800 Getr. / GBox: 6 AS 800 Abgasnorm: Euro 6 / Exhaust Emission Norm: Euro 6 (4)
			 3400 700 603 ⊗ 3482 001 166 ⊗ 1878 007 172 ⊙ 3151 000 397	350 MF350 350WGTZ KZIS-4	Getr. / GBox: S5-42 Abgasnorm: Euro 6 / Exhaust Emission Norm: Euro 6 (4)
LF 220		PX-7164	 3400 700 473 ⊗ 3482 000 474 ⊗ 1878 005 599 ⊙ 3151 000 651	395 10 MF395 395WGTZ KZIS-4	Getr. / GBox: 6S800 / 6S1000 Getr. / GBox: 9S1110TD Getr. / GBox: 6AS800 / 6AS1000 Abgasnorm: Euro 6 / Exhaust Emission Norm: Euro 6 (4)
LF 250		PX-7186	 3400 700 473 ⊗ 3482 000 474 ⊗ 1878 005 599 ⊙ 3151 000 651	395 10 MF395 395WGTZ KZIS-4	Getr. / GBox: 6S800 / 6S1000 Getr. / GBox: 9S1110TD Getr. / GBox: 6AS800 / 6AS1000 Abgasnorm: Euro 6 / Exhaust Emission Norm: Euro 6 (4)
LF 280		PX-7208	 3400 700 473 ⊗ 3482 000 474 ⊗ 1878 005 599 ⊙ 3151 000 651	395 10 MF395 395WGTZ KZIS-4	Getr. / GBox: 6S800 / 6S1000 Getr. / GBox: 9S1110TD Getr. / GBox: 6AS800 / 6AS1000 Abgasnorm: Euro 6 / Exhaust Emission Norm: Euro 6 (4)
LF 310		PX-7231	 3400 700 473 ⊗ 3482 000 474 ⊗ 1878 005 599 ⊙ 3151 000 651	395 10 MF395 395WGTZ KZIS-4	Getr. / GBox: 6S800 / 6S1000 Getr. / GBox: 9S1110TD Getr. / GBox: 6AS800 / 6AS1000 Abgasnorm: Euro 6 / Exhaust Emission Norm: Euro 6 (4)

65 01.93 - 02.98



















FA 65.180	03.93 - 02.98	NS133L, NS177M, NS133M, NS156M, NS156L	 3400 700 405 ⊗ 3482 000 419 ⊗ 1878 044 631 ⊙ 3151 000 395	362 10 MF362 362GTZ KZIS-4	Getr. / GBox: 6S850
FA 65.210	03.93 - 02.98		 3400 700 428 # ⊗ 3482 000 419 ⊗ 1878 044 631 ⊙ 3151 199 001	362 10 MF362 362GTZ KZIS-3	Getr. / GBox: ZF 6S-36
FA 65.240	05.96 - 02.98		 3482 060 132	350 MF350	Getr. / GBox: ZF 6S-36 Getr. / GBox: ZF 9S-75
FAV 65.180	03.93 - 02.98		 1861 777 043	350 10 350GTD	Getr. / GBox: ZF 6S-36 Getr. / GBox: ZF 9S-75
FAV 65.210	03.93 - 02.98		 3151 199 001	KZIS-3	Getr. / GBox: ZF 6S-36 Getr. / GBox: ZF 9S-75
			 3400 700 318 # ⊗ 3482 000 419 ⊗ 1878 002 071 ⊙ 3151 000 395	362 10 MF362 362GTZ KZIS-4	Getr. / GBox: ZF 9S-75

65 CF 02.98 - 12.00

FA 65 CF 180	02.98 - 12.00	NS177M, NS133M, NS156M	 3400 700 405 ⊗ 3482 000 419 ⊗ 1878 044 631 ⊙ 3151 000 395	362 10 MF362 362GTZ KZIS-4	Fahrzeuge können mit unterschiedlichen Komponenten bestückt sein. / Vehicles may be fitted with different components (21)
FA 65 CF 210	02.98 - 12.00				
FA 65 CF 240	02.98 - 12.00				
FAV 65 CF 180	02.98 - 12.00				
FAV 65 CF 210	02.98 - 12.00				

















		CODE				
--	--	------	--	---	---	---

DAF











































































CF 65		01.01 -					
FA 65.180 FA 65.220	01.01 -	CE136C, CE162C	 3400 700 308 ⊗ 3482 123 839 ⊗ 1878 000 036 ⊙ 3151 000 395	395 10 MF395 395WGTZ KZIS-4	Getr. / GBox: ZF-6S-850		
	01.01 -		 3400 700 527 ■	395 10	XTend Getr. / GBox: ZF-6S-850 Nabenprofil / Hub Profile: 30,7x38,4-10N Nur zusammen verbauen / Only install together	(46) (51)	
			 3400 700 316 ⊗ 3482 123 839 ⊗ 1878 000 296 ⊙ 3151 000 395	395 10 MF395 395WGTZ KZIS-4	Getr. / GBox: Eaton 6309		
			 3400 700 519 ■	395 10	XTend Getr. / GBox: Eaton 6309 Nabenprofil / Hub Profile: 38,2x44,5-10N Nur zusammen verbauen / Only install together	(46) (51)	
FA 65.220 FA 65.250	05.06 -	GR165S1, GR184S1	 3400 700 523 ■	395 10	XTend Getr. / GBox: ZF Nabenprofil / Hub Profile: 38,2x44,5-10N Nur zusammen verbauen / Only install together	(46) (51)	
	05.06 -		 3400 700 376 ⊗ 3482 000 474 ⊗ 1878 003 332 ⊙ 3151 000 651	395 10 MF395 395WGTZ KZIS-4	Getr. / GBox: ZF		
			 3400 700 473 ⊗ 3482 000 474 ⊗ 1878 005 599 ⊙ 3151 000 651	395 10 MF395 395WGTZ KZIS-4	Getr. / GBox: ZF 6S/800, 6S/1000 Abgasnorm: Euro 5 / Exhaust Emission Norm: Euro 5	(3)	
			 3400 700 524 ■	395 10	XTend Getr. / GBox: Eaton Nabenprofil / Hub Profile: 38,2x44,5-10N Nur zusammen verbauen / Only install together	(46) (51)	
			 3400 700 476 ⊗ 3482 000 474 ⊗ 1878 005 599 ⊙ 3151 000 395	395 10 MF395 395WGTZ KZIS-4	Getr. / GBox: Eaton Abgasnorm: Euro 5 / Exhaust Emission Norm: Euro 5	(3)	
FA 65.250	01.01 -	CE184C	 3400 700 308 ⊗ 3482 123 839 ⊗ 1878 000 036 ⊙ 3151 000 395	395 10 MF395 395WGTZ KZIS-4	Getr. / GBox: ZF-6S-850		
			 3400 700 527 ■	395 10	XTend Getr. / GBox: ZF-6S-850 Nabenprofil / Hub Profile: 30,7x38,4-10N Nur zusammen verbauen / Only install together	(46) (51)	
			 3400 700 473 ⊗ 3482 000 474 ⊗ 1878 005 599 ⊙ 3151 000 651	395 10 MF395 395WGTZ KZIS-4	Getr. / GBox: ZF 6S/800, 6S/1000 Abgasnorm: Euro 5 / Exhaust Emission Norm: Euro 5	(3)	
			 3400 700 316 ⊗ 3482 123 839 ⊗ 1878 000 296 ⊙ 3151 000 395	395 10 MF395 395WGTZ KZIS-4	Getr. / GBox: Eaton 6309		
			 3400 700 519 ■	395 10	XTend Getr. / GBox: Eaton 6309 Nabenprofil / Hub Profile: 38,2x44,5-10N Nur zusammen verbauen / Only install together	(46) (51)	
			 3400 700 476 ⊗ 3482 000 474 ⊗ 1878 005 599 ⊙ 3151 000 395	395 10 MF395 395WGTZ KZIS-4	Getr. / GBox: Eaton Abgasnorm: Euro 5 / Exhaust Emission Norm: Euro 5	(3)	
FA 65.290	05.06 -	GR210S1	 3400 700 523 ■	395 10	XTend Getr. / GBox: ZF Nabenprofil / Hub Profile: 38,2x44,5-10N Nur zusammen verbauen / Only install together	(46) (51)	
			 3400 700 376 ⊗ 3482 000 474 ⊗ 1878 003 332 ⊙ 3151 000 651	395 10 MF395 395WGTZ KZIS-4	Getr. / GBox: ZF		
			 3400 700 524 ■	395 10	XTend Getr. / GBox: Eaton Nabenprofil / Hub Profile: 38,2x44,5-10N Nur zusammen verbauen / Only install together	(46) (51)	

DAF

75 07.92 - 02.98















































FA 75.240 FAG 75.240,FAN 75.240 FAR 75.240,FAS 75.240 FAV 75.240 FT 75.240	07.92-02.98 07.92-02.98 07.92-02.98 07.92-02.98 07.92-02.98	RS180, RS180M, RS180L	    	3400 124 701 ⊗ 3482 017 034 ⊗ 1878 000 105 ⊙ 3151 000 395	380 10 GMF380 380GTZ KZIS-4		
FA 75.270 FA 75.300 FAG 75.270,FAN 75.270 FAG 75.300,FAN 75.300 FAR 75.270,FAS 75.270 FAR 75.300,FAS 75.300 FAT 75.270 FAV 75.270 FT 75.270 FT 75.300	07.92-02.98 07.92-02.98 07.92-02.98 07.92-02.98 07.92-02.98 07.92-02.98 07.92-02.98 07.92-02.98 07.92-02.98 07.92-02.98	RS200L, RS222, RS200M, RS222M, RS222L, RS200	          	3400 700 319 ⊗ 3482 119 032 ⊗ 1878 027 231 ⊙ 3151 000 395	430 10 GMF430 400GTZ KZIS-4		

75 CF 02.98 - 12.00

FA 75 CF 250 FA 75 CF 290 FAG 75 CF 250,FAN 75 CF 250 FAG 75 CF 290,FAN 75 CF 290 FAR 75 CF 250,FAS 75 CF 250 FAR 75 CF 290,FAS 75 CF 290 FAT 75 CF 250 FAT 75 CF 290	02.98-12.00 02.98-12.00 02.98-12.00 02.98-12.00 02.98-12.00 02.98-12.00 02.98-12.00 02.98-12.00	PF183M, PF212M	          	3400 700 319 ⊗ 3482 119 032 ⊗ 1878 027 231 ⊙ 3151 000 395	430 10 GMF430 400GTZ KZIS-4		
			       	3400 700 504 ■	430 10 GMF430N	XTend Getr. / GBox: 8/16S151 Nabenprofil / Hub Profile: 41,1x50,8-10N Nur zusammen verbauen / Only install together	(46) (51)
			    	3482 114 032 1878 054 933 3151 263 031	430 GMFZ430N 430 10 430GTZ KZIZ-6	für Nebenantrieb / for PTO für Nebenantrieb / for PTO für Nebenantrieb / for PTO	(82) (82) (82)
FA 75 CF 320 FAG 75 CF 320,FAN 75 CF 320 FAR 75 CF 320,FAS 75 CF 320 FAT 75 CF 320	02.98-12.00 02.98-12.00 02.98-12.00 02.98-12.00	PF235M	          	3400 122 101 ⊗ 3482 083 032 ⊗ 1878 054 933 ⊙ 3151 000 034	430 10 MFZ430 430GTZ KZISZ-5	Getr. / GBox: 8/16S151	
			       	3400 700 504 ■	430 10 GMFZ430N	XTend Getr. / GBox: 8/16S151 Nabenprofil / Hub Profile: 41,1x50,8-10N Nur zusammen verbauen / Only install together	(46) (51)
			    	3482 114 032 1878 054 933 3151 263 031	430 GMFZ430N 430 10 430GTZ KZIZ-6	für Nebenantrieb / for PTO für Nebenantrieb / for PTO für Nebenantrieb / for PTO	(82) (82) (82)
FT 75 CF 250 FT 75 CF 290	02.98-12.00 02.98-12.00	PF183M, PF212M	       	3400 700 319 ⊗ 3482 119 032 ⊗ 1878 027 231 ⊙ 3151 000 395	430 10 GMF430 400GTZ KZIS-4		
			    	3400 700 504 ■	430 10 GMF430N	XTend Getr. / GBox: 8/16S151 Nabenprofil / Hub Profile: 41,1x50,8-10N Nur zusammen verbauen / Only install together	(46) (51)
FT 75 CF 320	02.98-12.00	PF235M	       	3400 122 101 ⊗ 3482 083 032 ⊗ 1878 054 933 ⊙ 3151 000 034	430 10 MFZ430 430GTZ KZISZ-5	Getr. / GBox: 8/16S151	
			    	3400 700 504 ■	430 10 MFZ430N	XTend Getr. / GBox: 8/16S151 Nabenprofil / Hub Profile: 41,1x50,8-10N Nur zusammen verbauen / Only install together	(46) (51)

		CODE				
--	--	------	--	---	---	---





DAF

CF 75		01.01 -				
FA 75.250 FA 75.310 FAD 75.310 FAG 75.250, FAN 75.250 FAG 75.310, FAN 75.310 FAR 75.310, FAS 75.310 FAT 75.250 FAT 75.310 FT 75.250 FT 75.310	01.01 - 01.01 - 01.01 - 01.01 - 01.01 - 01.01 - 01.01 - 01.01 - 01.01 -	PE228C, PR228S, PE183C, PR183S	 3400 122 101  3482 083 032  1878 054 933  3151 000 034	430 10 MFZ430 430GTZ KZISZ-5	Getr. / GBox: 8S-151/16S-151	
	 3400 700 504 		430 10 XTend Getr. / GBox: 8S-151/16S-151 Nabenteil / Hub Profile: 41,1x50,8-10N Nur zusammen verbauen / Only install together	(46) (51)		
	 3400 700 316  3482 123 839  1878 000 296  3151 000 395		395 10 MF395 395WGTZ KZIS-4	Getr. / GBox: 9S-109/16S109		
	 3400 700 519 		395 10 XTend Getr. / GBox: 9S-109/16S109 Nabenteil / Hub Profile: 38,2x44,5-10N Nur zusammen verbauen / Only install together	(46) (51)		
	 3400 700 368  3482 000 484  1878 003 647  3151 000 493		430 10 MFZ430 430GTZ KZISZ-5	Getr. / GBox: ZF AS-Tronic Abgasnorm: Euro 5 / Exhaust Emission Norm: Euro 5 für Ausrückgabel mit Rollen / for release fork with rollers	(3) (70)	
	 3400 700 520 		395 10 XTend Getr. / GBox: ZF Ecomid ZF 9S - Nabenteil / Hub Profile: 38,2x44,5-10N Abgasnorm: Euro 5 / Exhaust Emission Norm: Euro 5 Nur zusammen verbauen / Only install together	(46) (3) (51)		
	 3400 700 316  3482 123 839  1878 000 296  3151 000 395		395 10 MF395 395WGTZ KZIS-4	Getr. / GBox: 9S-109/16S109 Abgasnorm: Euro3/Euro4 / Exhaust Emission Norm: Euro3/Euro4	(5)	
FA 75.360 FAD 75.360 FAG 75.360, FAN 75.360 FAR 75.360, FAS 75.360 FAT 75.360 FT 75.360	01.01 - 01.01 - 01.01 - 01.01 - 01.01 - 01.01 -	PR265S, PE265C	 3400 700 519 	395 10 XTend Getr. / GBox: 9S-109/16S109 Nabenteil / Hub Profile: 38,2x44,5-10N Abgasnorm: Euro3/Euro4 / Exhaust Emission Norm: Euro3/Euro4 Nur zusammen verbauen / Only install together	(46) (5) (51)	
	 3400 122 101  3482 083 032  1878 054 933  3151 000 034		430 10 MFZ430 430GTZ KZISZ-5	Getr. / GBox: Ecosplit 3 Abgasnorm: Euro 3 / Exhaust Emission Norm: Euro 3	(1)	
	 3400 700 504 		430 10 XTend Getr. / GBox: Ecosplit 3 Nabenteil / Hub Profile: 41,1x50,8-10N Abgasnorm: Euro 3 / Exhaust Emission Norm: Euro 3 Nur zusammen verbauen / Only install together	(46) (1) (51)		
	 3400 700 361  3482 000 484  1878 003 767  3151 000 034		430 10 MFZ430 430WGTZ KZISZ-5	Getr. / GBox: Ecosplit 3 Abgasnorm: Euro4/Euro5 / Exhaust Emission Norm: Euro4/Euro5	(6)	
	 3400 700 521 		430 10 XTend Getr. / GBox: Ecosplit 3 Nabenteil / Hub Profile: 41,1x50,8-10N Abgasnorm: Euro4/Euro5 / Exhaust Emission Norm: Euro4/Euro5	(46) (6)		
	 3400 700 467  3482 000 484  1878 003 767  3151 000 493		430 10 MFZ430 430WGTZ KZISZ-5	Getr. / GBox: Ecosplit 4 Abgasnorm: Euro 5 / Exhaust Emission Norm: Euro 5	(3)	
	 3400 700 522 		430 10 XTend Getr. / GBox: Ecosplit 4 Nabenteil / Hub Profile: 41,1x50,8-10N Abgasnorm: Euro 5 / Exhaust Emission Norm: Euro 5 für Ausrückgabel mit Rollen / for release fork with rollers	(46) (3) (70)		
	 3400 700 368  3482 000 484  1878 003 647  3151 000 493		430 10 MFZ430 430GTZ KZISZ-5	Getr. / GBox: AS Tronic Abgasnorm: Euro3/Euro4 / Exhaust Emission Norm: Euro3/Euro4 Abgasnorm: Euro 5 / Exhaust Emission Norm: Euro 5 für Ausrückgabel mit Rollen / for release fork with rollers	(5) (3) (70)	
	 3400 700 522 		430 10 XTend Getr. / GBox: AS Tronic Nabenteil / Hub Profile: 41,1x50,8-10N Abgasnorm: Euro3/Euro4 / Exhaust Emission Norm: Euro3/Euro4 für Ausrückgabel mit Rollen / for release fork with rollers	(46) (5) (70)		

























		CODE				
--	--	------	--	---	---	---

DAF

CF 75 01.01 -



















FAR 75.250, FAS 75.250	01.01 -	PE183C, PR183S	 3400 122 101 ⊗ 3482 083 032 ⊗ 1878 054 933 ⊙ 3151 000 034	430 10 MFZ430 430GTZ KZISZ-5	Getr. / GBox: 8S-151/16S-151	
			 3400 700 504 ●■	430 10 XTend	Getr. / GBox: 8S-151/16S-151 Nabenprofil / Hub Profile: 41,1x50,8-10N Nur zusammen verbauen / Only install together	(46) (51)
			 3400 700 316 ⊗ 3482 123 839 ⊗ 1878 000 296 ⊙ 3151 000 395	395 10 MF395 395WGTZ KZIS-4	Getr. / GBox: 9S-109/16S109	
			 3400 700 519 ●■	395 10 XTend	Getr. / GBox: 9S-109/16S109 Nabenprofil / Hub Profile: 38,2x44,5-10N Nur zusammen verbauen / Only install together	(46) (51)

85 07.92 - 02.98







F 85.300 FA 85.330 FA 85.360 FAD 85.330 FAD 85.360 FAG 85.360, FAR 85.360, FAS 85.360 FAT 85.330 FAT 85.360	01.92 - 07.92 - 02.98 07.92 - 02.98 07.92 - 02.98 07.92 - 02.98 07.92 - 02.98 07.92 - 02.98 07.92 - 02.98	WS268L, WS242L, WS268, WS268M, WS242, WS242M	 3400 121 101 ⊗ 3482 119 031 ⊗ 1878 002 878 ⊙ 3151 182 233	430 10 GMF430 420GTZ KZI-5		
			 3482 018 132 ●#	420 GMF420		
			 3482 114 032	430 GMFZ430N	für Nebenantrieb / for PTO	(82)
			 1878 054 933	430 10 430GTZ	für Nebenantrieb / for PTO	(82)
			 3151 263 031	KZIZ-6	für Nebenantrieb / for PTO	(82)
			 3400 122 101 ⊗ 3482 083 032 ⊗ 1878 054 933 ⊙ 3151 000 034	430 10 MFZ430 430GTZ KZISZ-5	Getr. / GBox: 8/16S151/181/221	
			 3482 114 032	430 GMFZ430N	für Nebenantrieb / for PTO	(82)
FA 85.400 FAD 85.400 FAG 85.400, FAR 85.400, FAS 85.400 FAT 85.400	03.95 - 02.98 03.95 - 02.98 03.95 - 02.98 03.95 - 02.98	WS295M	 3400 121 101 ⊗ 3482 119 031 ⊗ 1878 002 878 ⊙ 3151 182 233	430 10 GMF430 420GTZ KZI-5		
			 3482 018 132 ●#	420 GMF420		
			 3482 114 032	430 GMFZ430N	für Nebenantrieb / for PTO	(82)
			 1878 054 933	430 10 430GTZ	für Nebenantrieb / for PTO	(82)
FAG 85.330, FAR 85.330, FAS 85.330	07.92 - 02.98	-SE1160, DK, -S, -TL, -TD,	 3400 700 305 ⊗ 3482 118 031 ⊗ 1878 002 706 ⊙ 3151 000 515	430 10 GMF430 420GTZ KZIS-4		
			 3400 121 101 ⊗ 3482 119 031 ⊗ 1878 002 878 ⊙ 3151 182 233	430 10 GMF430 420GTZ KZI-5		
			 3482 018 132 ●#	420 GMF420		
		 3482 114 032	430 GMFZ430N	für Nebenantrieb / for PTO	(82)	
		 1878 054 933	430 10 430GTZ	für Nebenantrieb / for PTO	(82)	
		 3151 263 031	KZIZ-6	für Nebenantrieb / for PTO	(82)	
FT 85.330 FT 85.360 FTG 85.330 FTG 85.360 FTT 85.330 FTT 85.360	07.92 - 02.98 07.92 - 02.98 07.92 - 02.98 07.92 - 02.98 07.92 - 02.98 07.92 - 02.98	WS268L, WS242L, WS268M, WS242, WS242M	 3400 121 101 ⊗ 3482 119 031 ⊗ 1878 002 878 ⊙ 3151 182 233	430 10 GMF430 420GTZ KZI-5		
			 3482 018 132 ●#	420 GMF420		
			 3400 122 101 ⊗ 3482 083 032 ⊗ 1878 054 933 ⊙ 3151 000 034	430 10 MFZ430 430GTZ KZISZ-5	Getr. / GBox: 8/16S151/181/221	
FT 85.400 FTG 85.400	03.95 - 02.98 03.95 - 02.98	WS295M	 3400 122 101 ⊗ 3482 083 032 ⊗ 1878 054 933 ⊙ 3151 000 034	430 10 MFZ430 430GTZ KZISZ-5	Getr. / GBox: 8/16S151/181/221	
			 1878 001 138	420 10 420GTZ		
FTT 85.400	03.95 - 02.98	WS295M	 3400 122 101 ⊗ 3482 083 032 ⊗ 1878 054 933 ⊙ 3151 000 034	430 10 MFZ430 430GTZ KZISZ-5	Getr. / GBox: 8/16S151/181/221	
			 3151 000 515	KZIS-4		

		CODE				
--	--	------	--	---	---	---

DAF







85 CF		02.98 - 12.00				
FA 85 CF 340	02.98-12.00	XF250M	 3400 122 101 ⊗ 3482 083 032 ⊗ 1878 054 933 ⊙ 3151 000 034	430 10 MFZ430 430GTZ KZISZ-5	Getr. / GBox: ZF S16-151	
FAC 85 CF 340	02.98-12.00					
FAD 85 CF 340	02.98-12.00					
FAG 85 CF 340, FAN 85 CF 340	02.98-12.00		 3400 700 504 ●■	430 10	XTend Getr. / GBox: 8/16S-151/181/221 Nabenprofil / Hub Profile: 41,1x50,8-10N Nur zusammen verbauen / Only install together	(46) (51)
FAR 85 CF 340	02.98-12.00					
FAS 85 CF 340	02.98-12.00					
FAT 85 CF 340	02.98-12.00		 3400 121 001 ⊗ 3482 119 031 ⊗ 1878 054 933 ⊙ 3151 182 233	430 10 GMF430 430GTZ KZI-5	Getr. / GBox: Fuller Austauschteil ersetzt durch 3400 121 002 / replacement part substituted by (successor) 3400 121 002	(12)
		 3482 114 032	430 GMFZ430N	für Nebenantrieb / for PTO	(82)	
		 1878 054 933	430 10 430GTZ	für Nebenantrieb / for PTO	(82)	
		 3151 263 031	KZIZ-6	für Nebenantrieb / for PTO	(82)	
FA 85 CF 380	02.98-12.00	XF315M, XF280M	 3400 122 101 ⊗ 3482 083 032 ⊗ 1878 054 933 ⊙ 3151 000 034	430 10 MFZ430 430GTZ KZISZ-5	Getr. / GBox: ZF S16-181	
FA 85 CF 430	02.98-12.00					
FAC 85 CF 380	02.98-12.00					
FAC 85 CF 430	02.98-12.00		 3400 700 504 ●■	430 10	XTend Getr. / GBox: 8/16S-151/181/221 Nabenprofil / Hub Profile: 41,1x50,8-10N Nur zusammen verbauen / Only install together	(46) (51)
FAD 85 CF 380	02.98-12.00					
FAD 85 CF 430	02.98-12.00					
FAG 85 CF 380, FAN 85 CF 380	02.98-12.00		 3400 121 001 ⊗ 3482 119 031 ⊗ 1878 054 933 ⊙ 3151 182 233	430 10 GMF430 430GTZ KZI-5	Getr. / GBox: Fuller Austauschteil ersetzt durch 3400 121 002 / replacement part substituted by (successor) 3400 121 002	(12)
FAG 85 CF 430, FAN 85 CF 430	02.98-12.00					
FAR 85 CF 380	02.98-12.00					
FAR 85 CF 430	02.98-12.00		 3482 114 032	430 GMFZ430N	für Nebenantrieb / for PTO	(82)
FAS 85 CF 380	02.98-12.00		 1878 054 933	430 10 430GTZ	für Nebenantrieb / for PTO	(82)
FAS 85 CF 430	02.98-12.00	 3151 263 031	KZIZ-6	für Nebenantrieb / for PTO	(82)	
FAT 85 CF 380	02.98-12.00					
FAT 85 CF 430	02.98-12.00					
FT 85 CF 340	02.98-12.00	XF250M	 3400 122 101 ⊗ 3482 083 032 ⊗ 1878 054 933 ⊙ 3151 000 034	430 10 MFZ430 430GTZ KZISZ-5	Getr. / GBox: ZF S16-151	
FTG 85 CF 340	02.98-12.00					
FTT 85 CF 340	02.98-12.00		 3400 700 504 ●■	430 10	XTend Getr. / GBox: 8/16S-151/181/221 Nabenprofil / Hub Profile: 41,1x50,8-10N Nur zusammen verbauen / Only install together	(46) (51)
		 3400 121 001 ⊗ 3482 119 031 ⊗ 1878 054 933 ⊙ 3151 182 233	430 10 GMF430 430GTZ KZI-5	Getr. / GBox: Fuller Austauschteil ersetzt durch 3400 121 002 / replacement part substituted by (successor) 3400 121 002	(12)	
FT 85 CF 380	02.98-12.00	XF315M, XF280M	 3400 122 101 ⊗ 3482 083 032 ⊗ 1878 054 933 ⊙ 3151 000 034	430 10 MFZ430 430GTZ KZISZ-5	Getr. / GBox: ZF S16-181	
FT 85 CF 430	02.98-12.00					
FTG 85 CF 380	02.98-12.00					
FTG 85 CF 430	02.98-12.00		 3400 700 504 ●■	430 10	XTend Getr. / GBox: 8/16S-151/181/221 Nabenprofil / Hub Profile: 41,1x50,8-10N Nur zusammen verbauen / Only install together	(46) (51)
FTT 85 CF 380	02.98-12.00					
FTT 85 CF 430	02.98-12.00	 3400 121 001 ⊗ 3482 119 031 ⊗ 1878 054 933 ⊙ 3151 182 233	430 10 GMF430 430GTZ KZI-5	Getr. / GBox: Fuller Austauschteil ersetzt durch 3400 121 002 / replacement part substituted by (successor) 3400 121 002	(12)	









DAF

CF 85		01.01 -				
FA 85.340	01.01 -	XE250C, XE315C, XE355C, XE280C		3400 122 101	430 10	Getr. / GBox: 16S-151/181/221
FA 85.380	01.01 -			 3482 083 032	MFZ430	
FA 85.430	01.01 -			 1878 054 933	430GTZ	
FA 85.480	01.01 -			 3151 000 034	KZISZ-5	
FAD 85.340	01.01 -			3400 700 504 	430 10	XTend
FAD 85.380	01.01 -					Getr. / GBox: 16S-151/181/221
FAD 85.430	01.01 -					Nabenprofil / Hub Profile: 41,1x50,8-10N
FAD 85.480	01.01 -					Nur zusammen verbauen / Only install together
FAG 85.340, FAN 85.340	01.01 -					(46)
FAG 85.380, FAN 85.380	01.01 -					(51)
FAG 85.430, FAN 85.430	01.01 -					
FAG 85.480, FAN 85.480	01.01 -					
FAR 85.340, FAS 85.340	01.01 -					
FAR 85.380, FAS 85.380	01.01 -					
FAR 85.430, FAS 85.430	01.01 -					
FAR 85.480, FAS 85.480	01.01 -					
FAT 85.340	01.01 -					
FAT 85.380	01.01 -					
FAT 85.430	01.01 -					
FAT 85.480	01.01 -					
FT 85.340	01.01 -					
FT 85.380	01.01 -					
FT 85.430	01.01 -					
FT 85.480	01.01 -					
FTG 85.340	01.01 -					
FTG 85.380	01.01 -					
FTG 85.480	01.01 -					
FTT 85.340	01.01 -					
FTT 85.380	01.01 -					
FTT 85.430	01.01 -					
FTT 85.480	01.01 -					

		CODE				
--	--	------	--	---	---	---

DAF













CF 85		01.01 -									
FA 85.360	10.06-	MX340, MX375, MX265, MX300		3400 700 361	430 10	Getr. / GBox: Ecosplit					
FA 85.410	10.06-			⊗ 3482 000 484	MFZ430						
FA 85.460	10.06-			⊗ 1878 003 767	430WGTZ						
FA 85.510	10.06-			⊗ 3151 000 034	KZISZ-5						
FAC 85.360, FAX 85.360	10.06-				3400 700 521 	430 10	XTend				
FAC 85.410, FAX 85.410	10.05-				Getr. / GBox: Ecosplit						
FAC 85.460, FAX 85.460	10.05-				Nabenprofil / Hub Profile: 41,1x50,8-10N			(46)			
FAC 85.510, FAX 85.510	10.05-					3400 700 368	430 10	Getr. / GBox: AS Tronic			
FAD 85.360	10.06-					⊗ 3482 000 484	MFZ430	für Ausrückgabel mit Rollen / for release fork with	(70)		
FAD 85.410	10.05-					⊗ 1878 003 647	430GTZ	rollers			
FAD 85.460	10.05-					⊗ 3151 000 493	KZISZ-5				
FAD 85.510	10.05-						3400 700 522 	430 10	XTend		
FAG 85.360, FAN 85.360	10.06-						Getr. / GBox: AS Tronic			(46)	
FAG 85.410, FAN 85.410	10.05-						Nabenprofil / Hub Profile: 41,1x50,8-10N			(70)	
FAG 85.460, FAN 85.460	10.05-						für Ausrückgabel mit Rollen / for release fork with				
FAG 85.510, FAN 85.510	10.05-						rollers				
FAR 85.360, FAS 85.360	10.06-										
FAR 85.410, FAS 85.410	10.05-										
FAR 85.460, FAS 85.460	10.05-										
FAR 85.510, FAS 85.510	10.05-										
FTG 85.360	10.06-										
FTG 85.410	10.05-										
FTG 85.460	10.05-										
FTG 85.510	10.05-										
FTR 85.360; FTS 85.360, FTP 85.360	10.06-										
FTR 85.410, FTS 85.410, FTP 85.410	10.05-										
FTR 85.460, FTS 85.460, FTP 85.460	10.05-										
FTR 85.510, FTS 85.510, FTP 85.510	10.05-										
FTT 85.360	10.06-										

CF		06.13 -					
CF 220	01.14-	PX-7164		3400 700 473	395 10	Getr. / GBox: 6S800 / 6S1000	
				⊗ 3482 000 474	MF395	Getr. / GBox: 9S1110TD	
				⊗ 1878 005 599	395WGTZ	Getr. / GBox: 6AS800 / 6AS1000	
				⊗ 3151 000 651	KZIS-4	Abgasnorm: Euro 6 / Exhaust Emission Norm: Euro 6	(4)
CF 250	01.14-	PX-7186		3400 700 473	395 10	Getr. / GBox: 6S800 / 6S1000	
				⊗ 3482 000 474	MF395	Getr. / GBox: 9S1110TD	
				⊗ 1878 005 599	395WGTZ	Getr. / GBox: 6AS800 / 6AS1000	
				⊗ 3151 000 651	KZIS-4	Abgasnorm: Euro 6 / Exhaust Emission Norm: Euro 6	(4)
CF 280	01.14-	PX-7208		3400 700 473	395 10	Getr. / GBox: 6S800 / 6S1000	
				⊗ 3482 000 474	MF395	Getr. / GBox: 9S1110TD	
				⊗ 1878 005 599	395WGTZ	Getr. / GBox: 6AS800 / 6AS1000	
				⊗ 3151 000 651	KZIS-4	Abgasnorm: Euro 6 / Exhaust Emission Norm: Euro 6	(4)
CF 290		MX-11210		3400 700 467	430 10	Getr. / GBox: AS Tronic	
				⊗ 3482 000 484	MFZ430	Abgasnorm: Euro 6 / Exhaust Emission Norm: Euro 6	(4)
				⊗ 1878 003 767	430WGTZ		
				⊗ 3151 000 493	KZISZ-5		
				3400 700 604	430 10	Getr. / GBox: Ecosplit4	
				⊗ 3482 001 184	MFZ430	Abgasnorm: Euro 6 / Exhaust Emission Norm: Euro 6	(4)
				⊗ 1878 004 573	430WGTZ		
				⊗ 3151 000 493	KZISZ-5		
CF 310	01.14-	PX-7231		3400 700 473	395 10	Getr. / GBox: 6S800/6S1000	
				⊗ 3482 000 474	MF395	Getr. / GBox: 6AS800/6AS1000	
				⊗ 1878 005 599	395WGTZ	Getr. / GBox: 9S1110TD	
				⊗ 3151 000 651	KZIS-4	Abgasnorm: Euro 6 / Exhaust Emission Norm: Euro 6	(4)
CF 330		MX-11240		3400 700 467	430 10	Getr. / GBox: AS Tronic	
				⊗ 3482 000 484	MFZ430	Abgasnorm: Euro 6 / Exhaust Emission Norm: Euro 6	(4)
				⊗ 1878 003 767	430WGTZ		
				⊗ 3151 000 493	KZISZ-5		
				3400 700 605	430 10	Getr. / GBox: 9S1110TD	
				⊗ 3482 001 171	MF430	Abgasnorm: Euro 6 / Exhaust Emission Norm: Euro 6	(4)
				⊗ 1878 085 742	430WGTZ		
				⊗ 3151 000 395	KZIS-4		



		CODE				
--	--	------	--	---	---	---

DAF

CF 06.13 -















































CF 370		MX-11271	 3400 700 467 ⊗ 3482 000 484 ⊗ 1878 003 767 ⊙ 3151 000 493	430 10 MFZ430 430WGTZ KZISZ-5	Getr. / GBox: AS Tronic Abgasnorm: Euro 6 / Exhaust Emission Norm: Euro 6	(4)
			 3400 700 605 ⊗ 3482 001 171 ⊗ 1878 085 742 ⊙ 3151 000 395	430 10 MF430 430WGTZ KZIS-4	Getr. / GBox: 9S1110TD Abgasnorm: Euro 6 / Exhaust Emission Norm: Euro 6	(4)
CF 400		MX-11291	 3400 700 467 ⊗ 3482 000 484 ⊗ 1878 003 767 ⊙ 3151 000 493	430 10 MFZ430 430WGTZ KZISZ-5	Getr. / GBox: AS Tronic Getr. / GBox: Ecosplit 4 Abgasnorm: Euro 6 / Exhaust Emission Norm: Euro 6	(4)
			 3400 700 522 ■	430 10	XTend Getr. / GBox: Ecosplit 4 Nabenprofil / Hub Profile: 41,1x50,8-10N Abgasnorm: Euro 6 / Exhaust Emission Norm: Euro 6 für Ausrückgabel mit Rollen / for release fork with rollers	(46) (4) (70)
CF 410		MX-13303	 3400 700 467 ⊗ 3482 000 484 ⊗ 1878 003 767 ⊙ 3151 000 493	430 10 MFZ430 430WGTZ KZISZ-5	Getr. / GBox: AS Tronic Getr. / GBox: Ecosplit 4 Abgasnorm: Euro 6 / Exhaust Emission Norm: Euro 6	(4)
			 3400 700 522 ■	430 10	XTend Getr. / GBox: Ecosplit 4 Nabenprofil / Hub Profile: 41,1x50,8-10N Abgasnorm: Euro 6 / Exhaust Emission Norm: Euro 6 für Ausrückgabel mit Rollen / for release fork with rollers	(46) (4) (70)
CF 440		MX-11320	 3400 700 467 ⊗ 3482 000 484 ⊗ 1878 003 767 ⊙ 3151 000 493	430 10 MFZ430 430WGTZ KZISZ-5	Getr. / GBox: AS Tronic Getr. / GBox: Ecosplit 4 Abgasnorm: Euro 6 / Exhaust Emission Norm: Euro 6	(4)
			 3400 700 522 ■	430 10	XTend Getr. / GBox: Ecosplit 4 Nabenprofil / Hub Profile: 41,1x50,8-10N Abgasnorm: Euro 6 / Exhaust Emission Norm: Euro 6 für Ausrückgabel mit Rollen / for release fork with rollers	(46) (4) (70)
CF 460		MX-13340	 3400 700 467 ⊗ 3482 000 484 ⊗ 1878 003 767 ⊙ 3151 000 493	430 10 MFZ430 430WGTZ KZISZ-5	Getr. / GBox: AS Tronic Getr. / GBox: Ecosplit 4 Abgasnorm: Euro 6 / Exhaust Emission Norm: Euro 6	(4)
			 3400 700 522 ■	430 10	XTend Getr. / GBox: Ecosplit 4 Nabenprofil / Hub Profile: 41,1x50,8-10N Abgasnorm: Euro 6 / Exhaust Emission Norm: Euro 6 für Ausrückgabel mit Rollen / for release fork with rollers	(46) (4) (70)
CF 510		MX-13375	 3400 700 467 ⊗ 3482 000 484 ⊗ 1878 003 767 ⊙ 3151 000 493	430 10 MFZ430 430WGTZ KZISZ-5	Getr. / GBox: AS Tronic Getr. / GBox: Ecosplit 4 Abgasnorm: Euro 6 / Exhaust Emission Norm: Euro 6	(4)
			 3400 700 522 ■	430 10	XTend Getr. / GBox: Ecosplit 4 Nabenprofil / Hub Profile: 41,1x50,8-10N Abgasnorm: Euro 6 / Exhaust Emission Norm: Euro 6 für Ausrückgabel mit Rollen / for release fork with rollers	(46) (4) (70)

95 09.87 - 01.98

FA 95.310	09.87 - 09.90	WS259, WS225	 3400 124 601 ⊗ 3482 119 031 ⊗ 1878 086 741 ⊙ 3151 000 395	430 10 GMF430 430WGTZ KZIS-4		
FA 95.350	09.87 - 09.90					
FAD 95.350	09.87 - 09.90		 3482 018 132 ●#	420 GMF420		
FAG 95.350, FAR 95.350, FAS 95.350	09.87 - 09.90		 3482 114 032	430 GMFZ430N	für Nebenantrieb / for PTO	(82)
FAR 95.310	09.87 - 09.90		 1878 054 933	430 10 430GTZ	für Nebenantrieb / for PTO	(82)
FAT 95.350	09.87 - 09.90		 3151 263 031	KZIZ-6	für Nebenantrieb / for PTO	(82)



		CODE				
--	--	------	--	---	---	---

DAF













95		09.87 - 01.98					
FA 95.330	08.90-01.93	WS268L,	 3400 121 101	430 10			
FA 95.360	08.90-01.98	WS268G,	 3482 119 031	GMF430			
FAD 95.360	08.90-01.98	WS268,	 1878 002 878	420GTZ			
FAG 95.360, FAR 95.360, FAS 95.360	08.90-01.98	WS268M,	 3151 182 233	KZI-5			
FAK 95.360	08.90-01.98	WS242	 3482 018 132 ●#	420			
FAR 95.330, FAS 95.330	08.90-01.93		 3482 114 032	430	für Nebenantrieb / for PTO		(82)
FAT 95.360	08.90-01.98		 1878 054 933	430 10	für Nebenantrieb / for PTO		(82)
			 3151 263 031	430GTZ	für Nebenantrieb / for PTO		(82)
				KZIZ-6	für Nebenantrieb / for PTO		(82)
FA 95.380	09.87-09.90	WS282	 3400 125 701	430 10			
FAD 95.380	09.87-09.90		 3482 119 031	GMF430			
FAG 95.380, FAR 95.380, FAS 95.380	09.87-09.90		 1878 003 269	420GTZ			
FAT 95.380	09.87-09.90		 3151 000 395	KZIS-4			
			 3482 018 132 ●#	420			
			 3482 114 032	430	für Nebenantrieb / for PTO		(82)
			 1878 054 933	430 10	für Nebenantrieb / for PTO		(82)
			 3151 263 031	430GTZ	für Nebenantrieb / for PTO		(82)
				KZIZ-6	für Nebenantrieb / for PTO		(82)
FA 95.400	08.90-01.98	WS315L,	 3400 121 001	430 10	Austauschteil ersetzt durch 3400 121 002 / replacement part substituted by (successor) 3400 121 002		(12)
FA 95.430	02.92-01.98	WS295G,	 3482 119 031	GMF430			
FAD 95.400	08.90-01.98	WS295,	 1878 054 933	430GTZ			
FAD 95.430	02.92-01.98	WS315,	 3151 182 233	KZI-5			
FAG 95.400, FAR 95.400, FAS 95.400	08.90-01.98	WS315M,	 3482 114 032	430	für Nebenantrieb / for PTO		(82)
FAG 95.430, FAR 95.430, FAS 95.430	02.92-01.98	WS295L,	 1878 054 933	430 10	für Nebenantrieb / for PTO		(82)
FAK 95.400	08.90-01.98	WS315G,	 3151 263 031	430GTZ	für Nebenantrieb / for PTO		(82)
FAK 95.430	02.92-01.98	WS295M		KZIZ-6	für Nebenantrieb / for PTO		(82)
FAT 95.400	08.90-01.98						
FAT 95.430	02.92-01.98						
FT 95.310	09.87-09.90	WS259,	 3400 124 601	430 10			
FT 95.350	09.87-09.90	WS225	 3482 119 031	GMF430			
FTG 95.350, FTS 95.350	09.87-09.90		 1878 086 741	430WGTZ			
FTT 95.350	09.87-09.90		 3151 000 395	KZIS-4			
			 3482 018 132 ●#	420			
				GMF420			
FT 95.330	08.90-01.93	WS268L,	 3400 121 101	430 10			
FT 95.360	08.90-01.98	WS268G,	 3482 119 031	GMF430			
FTG 95.360, FTR 95.360, FTS 95.360	08.90-01.98	WS268,	 1878 002 878	420GTZ			
FTT 95.360	08.90-01.98	WS268M,	 3151 182 233	KZI-5			
		WS242	 3482 018 132 ●#	420			
				GMF420			
FT 95.380	09.87-09.90	WS282	 3400 125 701	430 10			
FTG 95.380, FTS 95.380	09.87-09.90		 3482 119 031	GMF430			
FTT 95.380	09.87-09.90		 1878 003 269	420GTZ			
			 3151 000 395	KZIS-4			
			 3482 018 132 ●#	420			
				GMF420			
FT 95.400	08.90-01.98	WS315L,	 3400 121 001	430 10	Austauschteil ersetzt durch 3400 121 002 / replacement part substituted by (successor) 3400 121 002		(12)
FT 95.430	02.92-01.98	WS295G,	 3482 119 031	GMF430			
FTG 95.400, FTR 95.400, FTS 95.400	08.90-01.98	WS295,	 1878 054 933	430GTZ			
FTG 95.430, FTR 95.430, FTS 95.430	02.92-01.98	WS315,	 3151 182 233	KZI-5			
FTT 95.400	08.90-01.98	WS315M,					
FTT 95.430	02.92-01.98	WS295L,					
		WS295M					
FT 95.500	02.94-01.98	VF373M	 3400 122 101	430 10			
			 3482 083 032	MFZ430			
			 1878 054 933	430GTZ			
			 3151 000 034	KZISZ-5			

		CODE				
--	--	------	--	---	---	---

DAF



95 XF		01.97 - 09.02				
FA 95 XF 380	01.97-09.02	XF315M, XE315C, XF280M, XE280C	 3400 122 101 ● 3482 083 032 ● 1878 054 933 ● 3151 000 034	430 10 MFZ430 430GTZ KZISZ-5	Getr. / GBox: ZF S16-181	
FA 95 XF 430	01.97-09.02					
FAC 95 XF 380	01.97-09.02		 3400 121 001 ● 3482 119 031 ● 1878 054 933 ● 3151 182 233	430 10 GMF430 430GTZ KZI-5	Getr. / GBox: Fuller Austauschteil ersetzt durch 3400 121 002 / replacement part substituted by (successor) 3400 121 002	(12)
FAC 95 XF 430	01.97-09.02					
FAD 95 XF 380	01.97-09.02					
FAD 95 XF 430	01.97-09.02					
FAR 95 XF 380	01.97-09.02					
FAR 95 XF 430	01.97-09.02					
FAS 95 XF 380	01.97-09.02					
FAS 95 XF 430	01.97-09.02					
FAT 95 XF 380	01.97-09.02					
FAT 95 XF 430	01.97-09.02					
FT 95 XF 380	01.97-09.02					
FT 95 XF 430	01.97-09.02					
FTG 95 XF 380	01.97-09.02					
FTG 95 XF 430	01.97-09.02					
FTR 95 XF 380	01.97-09.02					
FTR 95 XF 430	01.97-09.02					
FTS 95 XF 380	01.97-09.02					
FTS 95 XF 430	01.97-09.02					
FTT 95 XF 380	01.97-09.02					
FTT 95 XF 430	01.97-09.02					
FA 95 XF 480	01.97-09.02	XF355M, VF390M, XE355C, XE390C	 3400 121 001 ● 3482 119 031 ● 1878 054 933 ● 3151 182 233	430 10 GMF430 430GTZ KZI-5	Getr. / GBox: Fuller Austauschteil ersetzt durch 3400 121 002 / replacement part substituted by (successor) 3400 121 002	(12)
FA 95 XF 530	01.97-09.02					
FAC 95 XF 480	01.97-09.02		3400 122 101 ● 3482 083 032 ● 1878 054 933 ● 3151 000 034	430 10 MFZ430 430GTZ KZISZ-5	Getr. / GBox: ZF S16-221	
FAC 95 XF 530	01.97-09.02					
FAD 95 XF 480	01.97-09.02					
FAD 95 XF 530	01.97-09.02					
FAR 95 XF 480	01.97-09.02					
FAR 95 XF 530	01.97-09.02					
FAS 95 XF 480	01.97-09.02					
FAS 95 XF 530	01.97-09.02					
FAT 95 XF 480	01.97-09.02					
FT 95 XF 480	01.97-09.02					
FT 95 XF 530	02.01-09.02					
FT 95 XF 530	01.97-09.02					
FTG 95 XF 480	01.97-09.02					
FTR 95 XF 480	01.97-09.02					
FTS 95 XF 480	01.97-09.02					
FTT 95 XF 480	01.97-09.02					
FTT 95 XF 530	01.97-09.02					

DAF



XF 95		09.02 - 12.06				
FA 95.380	09.02 - 12.06	XF315M,	 3400 122 101  3482 083 032  1878 054 933  3151 000 034	430 10 MFZ430 430GTZ KZISZ-5	Getr. / GBox: 16S-151/181/221	
FA 95.430	09.02 - 12.06	XF355M,				
FA 95.480	09.02 - 12.06	XE315C,				
FA 95.530	09.02 - 12.06	XE355C,				
FAD 95.380		XF280M,	 3400 700 504 	430 10	XTend Getr. / GBox: 16S-151/181/221 Nabenprofil / Hub Profile: 41,1x50,8-10N Nur zusammen verbauen / Only install together	(46) (51)
FAD 95.430		XE390C,				
FAD 95.480		XE280C				
FAD 95.530	09.02 -		 3400 700 489  3482 083 032  1878 054 933  3151 000 493	430 10 MFZ430 430GTZ KZISZ-5	Getr. / GBox: ZF AS Tronic für Ausrückgabel mit Rollen / for release fork with rollers	(70)
FAK 95.380						
FAK 95.430						
FAK 95.480			 3482 083 032	430 MFZ430	Getr. / GBox: ZF AS Tronic für Ausrückgabel mit Nocken / for release fork with cams	(69)
FAK 95.530	09.02 -					
FAN 95.380			 1878 054 933	430 10 430GTZ	Getr. / GBox: ZF AS Tronic für Ausrückgabel mit Nocken / for release fork with cams	(69)
FAN 95.430						
FAN 95.480						
FAN 95.530	09.02 -		 3151 000 144	KZISZ-5	Getr. / GBox: ZF AS Tronic für Ausrückgabel mit Nocken / for release fork with cams	(69)
FAR 95.380	09.02 - 12.06					
FAR 95.430	09.02 - 12.06					
FAR 95.480	09.02 - 12.06					
FAR 95.530	09.02 - 12.06					
FAS 95.380						
FAS 95.430						
FAS 95.480						
FAS 95.530	09.02 -					
FAT 95.380						
FAT 95.430						
FAT 95.480						
FAT 95.530	09.02 -					
FT 95.380	09.02 - 12.06					
FT 95.480	09.02 - 12.06					
FT 95.530	09.02 - 12.06					
FTG 95.380	09.02 - 12.06					
FTG 95.430	12.05 - 12.06					
FTG 95.480	12.05 - 12.06					
FTG 95.530	09.02 - 12.06					
FTM 95.380	12.05 - 12.06					
FTM 95.430	12.05 - 12.06					
FTM 95.480	12.05 - 12.06					
FTM 95.530	09.02 - 12.06					
FTP 95.380						
FTP 95.430						
FTP 95.480						
FTP 95.530	09.02 -					
FTR 95.380						
FTR 95.430						
FTR 95.480						
FTR 95.530	09.02 -					
FTS 95.380						
FTS 95.430						
FTS 95.480						
FTS 95.530	09.02 -					
FTT 95.380						
FTT 95.430						
FTT 95.480						
FTT 95.530	09.02 -					







		CODE				
--	--	------	--	---	---	---

DAF









XF		10.12 -					
FA 410	10.12-	MX-11320,		3400 700 467 • 3482 000 484 • 1878 003 767 • 3151 000 493	430 10 MFZ430 430WGTZ KZISZ-5	Getr. / GBox: Ecosplit 4 Getr. / GBox: AS Tronic	
FA 460	10.12-						
FA 440	10.12-	MX-13375, MX-13303, MX-13340		3400 700 522 ■	430 10	XTend Getr. / GBox: Ecosplit 4 Nabenprofil / Hub Profile: 41,1x50,8-10N für Ausrückgabel mit Rollen / for release fork with rollers	(46) (70)
FA 510	10.12-						
FAR 410	10.12-						
FAR 440	10.12-						
FAR 460	10.12-						
FAR 510	10.12-						
FT 410	10.12-						
FT 440	10.12-						
FT 460	10.12-						
FT 510	10.12-						
FTP 410	10.12-						
FTP 440	10.12-						
FTP 460	10.12-						
FTP 510	10.12-						

DEMAG

S ...							
SKG				1881 059 208	200 KS200		
				1860 049 056 #	200 10 200Z		











V ...							
V 35		WWMAKD112Z		1880 071 008	225 K225		
				1864 634 026	225 10 225Z		
V 42				1881 010 139 #	250 G250		
				1864 202 035 #	250 10 250Z		
				3151 045 001	KZI-2		
V 70 HL		312V		1863 100 030	GR-3	mit Anlaufring / with thrust ring	(88)

ENASA









1217 - 1437							
1217		9100Turbo		3482 124 542	420 GMF430		
				1861 902 032 #	380 10 380GTD		
1223		9220Turbo		3482 124 542	420 GMF430		
				1878 003 276	420 10 420GTZ		
1232				3482 083 113	430 MFZ430		
1234				1862 208 032	430 10 430GVZ		
1236							
1278							
1437		9156Turbo		3482 124 542	420 GMF430		
				1878 003 277	420 10 420GTZ		
				3151 145 101	KZI-5		

FAUN



A

AK 320 HB (DB-Mot.)			 1882 205 234	250 HBX250		
			 1861 291 136	250 10 250GTZ		
			 3151 045 001	KZI-2		
AK 320 HB (MWM-Mot.)	10.54-		 1862 039 015 #	280 10 280BZ		
			 1863 100 030	GR-3	mit Anlauftring / with thrust ring	(88)
AK 470 HB			 1878 001 074	350 10 350GTZ		
AS 22	01.48-		 1881 089 002	225 K225		
			 1860 039 028 #	225 10 225Z		
			 1859 600 001	GR.I/ZL		
			 1805 042 000			

F 24 - 284

F 24 F 284 D			 1881 009 201 #	250 G250		
			 1861 224 005 #	250 10 250GSZ		
			 1859 600 001	GR.I/ZL		
			 1805 042 000			
F 50 /440 V			 1880 092 415 #	310 G310		
			 1863 100 030	GR-3	mit Anlauftring / with thrust ring	(88)
			 1878 001 074	350 10 350GTZ		
F 56 /39 KA F 56 /41 K F 56 /43			 1863 100 030	GR-3	mit Anlauftring / with thrust ring	(88)





F 610 - 837





















F 610 /36 SA F 610 /36 ZAN F 610 /362			 1881 041 656 #	380 G380		
			 1863 009 100	GR-5	mit Anlauftring / with thrust ring	(88)
F 610 /36 VS F 610 /39 KAN F 610 /450 VL F 610 /465 V F 687 /43 KAN F 687 /44 KAN F 687 /49 V F 688 /36 S F 688 A F 689 /36 S F 689 /36 V F 689 /36 VS F 689 /41 KAN F 689 /47 K F 689 VL			 3151 000 395	KZIS-4		

		CODE				
--	--	------	--	---	---	---

FAUN



F 6083 - 6103						
F 6083 /42 K F 6083 /42 KA F 6083 /475 VL F 6103 /34 VS F 6103 /42 K F 6103 /42 KA F 6103 /475 VL				3151 000 395	KZIS-4	



K 20/37 - K 40/40						
K 20/37 K 20/37 A K 20/37 V K 20/37 VA				1881 039 532 #	350 G350KR	
				3151 000 395	KZIS-4	
K 20/37 K 20/37 A				3151 000 395	KZIS-4	
K 25/36 A K 25/36 V K 25/36 VA K 40/40 VL				1881 041 656 #	380 G380	
				1863 009 100	GR-5	mit Anlaufring / with thrust ring (88)

KF 15.21 - 100.53						
KF 15.21 /30 4x4 KF 15.21 /32 4x4				1881 041 656 #	380 G380	
				3151 000 395	KZIS-4	
KF 20.31 /42 (6 Zyl. Mot.)				1881 039 532 #	350 G350KR	
				1878 005 367	350 10 350WGTZ	
KF 20.31 /48 6x4 KF 20.31 /48 6x6				1881 039 532 #	350 G350KR	
				3151 000 395	KZIS-4	
				1882 325 139	380 G380	
				1878 000 104	380 10 380GTZ	
				3151 000 395	KZIS-4	
KF 30.31 /48 KF 30.41 /48 (8-Zyl.-Mot) KF 40.41 /50 (8-Zyl.-Mot)				1882 325 139	380 G380	
KF 30.31 /48 6x6 KF 30.41 /48 KF 30.41 /48 6x4 KF 30.41 /48 8x4				1881 039 532 #	350 G350KR	
				3151 000 395	KZIS-4	
				3151 000 395	KZIS-4	
KF 30.31 /54 6x6		KHD		1878 002 706	420 10 420GTZ	
KF 30.41 /48 8x6 KF 50.42 /483 8x6				1881 041 656 #	380 G380	
				3151 000 395	KZIS-4	
				1863 009 100	GR-5	mit Anlaufring / with thrust ring (88)
KF 30.41 /48 8x8 KF 60.43 /50 8x4 KF 60.43 /50 8x6 KF 60.43 /55 8x6 KF 60.52 /55 10x6 KF 70.43 /55 8x6				1881 041 656 #	380 G380	
				1863 009 100	GR-5	mit Anlaufring / with thrust ring (88)
KF 40.41 /48 10 Zyl. KF 40.41 /48 8x6 KF 40.41 /48 8x8 KF 50.42 /48 10-Zyl. KF 50.42 /48 8x6				3151 000 395	KZIS-4	















		CODE				
--	--	------	--	---	---	---



FAUN

KF 15.21 - 100.53						
KF 40.41 /48 8 Zyl. KF 40.41 /48 8x4 KF 50.42 /48 8-Zyl.				1882 325 139	380 G380	
				1878 000 104	380 10 380GTZ	
				3151 000 395	KZIS-4	

KRAKA 640						
KRAKA 640 (BMW-Mot. 427)				1881 065 101	180 KS180	
				1861 280 136	180 24 180CB	

L 908 - L 1212						
L 1212 L 1212 /375 VS 8x6 L 1212 /45 ZA				1881 041 656 #	380 G380	
				1863 009 100	GR-5	mit Anlauftring / with thrust ring (88)

LK 116 - LK 1512						
LK 116 /42 V 6x6 LK 606 /32 V LK 606 /38 V LK 906 /48 V LK 906 /48 V 6-Zyl.				1881 041 656 #	380 G380	
				3151 000 395	KZIS-4	
LK 606 /38 6x6				1882 325 139	380 G380	
				1878 000 104	380 10 380GTZ	
				3151 000 395	KZIS-4	
LK 906 /45 V LK 906 /45 V 6x6 LK 910 /483 10-Zyl. LK 910 /483 V LK 1210 /50 V 8x6 LK 1212 /485 III LK 1412 LK 1412 /64 V 10x6 LK 1508 /36 V LK 1512 /38 V 4x4				1881 041 656 #	380 G380	
				1863 009 100	GR-5	mit Anlauftring / with thrust ring (88)
LK 906 /48 6x4 LK 906 /48 6x6 LK 906 /48 V 6x4 LK 906 /48 V 8-Zyl. LK 906 /48 VH 6x4 LK 906 /60 V LK 910 /483				1881 039 532 #	350 G350KR	
				3151 000 395	KZIS-4	
LK 908 /48				1881 039 532 #	350 G350KR	
				1881 041 656 #	380 G380	
				3151 000 395	KZIS-4	
				1863 009 100	GR-5	mit Anlauftring / with thrust ring (88)
LK 910 /483 8-Zyl.				3151 000 395	KZIS-4	

TF						
TF 00.31/52 6x4				1882 325 139	380 G380	
				1878 000 104	380 10 380GTZ	
				3151 000 395	KZIS-4	

		CODE				
--	--	------	--	---	---	---





FREIGHTLINER

M Series (Business Class)

M2 Business Class		OM906		3400 700 526 	395	XTend Nur zusammen verbauen / Only install together	(51)
-------------------	--	-------	---	--	-----	---	------









HINO

TRUCK





FS2PLKD				3488 019 133 	380 GMFZ2/380	enthält eine Kupplungsscheibe / This part number includes one clutch disc	(66)
				1862 543 031 	380 10 380WGVZ	Lose Kupplungsscheibe / Loose clutch disc	(39)
				3100 023 031 • 3151 000 750 • 3180 001 008	KZIZ-5 KZISZ-5	In 3483/3488 enthalten / Contained in 3483, 3488	(30)

IVECO

DAILY I Kasten / Box 01.78 - 08.98

30-8 (10014131, 10014132, 10014137, 10014231, 10014232...)	01.78 - 12.89	8140.61		3000 434 001 • 1850 480 049 • 1862 977 001 • 3151 065 031	240 10 M240 240CB KZI-1	Getriebeummer / Transmission Number: 2815 10014131 / 10014132 / 10014137 / 10014231 / 10014232 / 10014237 / 10015131 / 10015132 / 10015232	(26)
35-8 (10034131, 10034132, 10034137, 10034224, 10034231...)	01.78 - 12.89	8140.61		3000 434 001 • 1850 480 049 • 1862 977 001 • 3151 065 031	240 10 M240 240CB KZI-1	Getriebeummer / Transmission Number: 2815 10034131 / 10034132 / 10034137 / 10034224 / 10034231 / 10034232 / 10034237 / 10035231 / 10035232 / 10035237	(26)
35-10 (10314204, 10314211, 10314212, 10314217, 10314411...)	01.85 - 12.89	8140.21		3400 700 429 • 3482 907 001 • 1862 967 001 • 3151 065 031	265 10 MF265 265TB KZI-1	Getriebeummer / Transmission Number: 2822 10314204 / 10314211 / 10314212 / 10314217 / 10314411 / 10314412 / 10314417 / 10315211 / 10315212	(26)
			8140.27S		3000 951 026 • 3083 039 031 • 1878 002 072 • 3151 600 529	235 10 MFZ235X 235VTB KZISZ-2	Getriebeummer / Transmission Number: 2826.5 13017231
				3400 117 701 • 3482 998 701 • 1878 997 101 • 3151 600 529	265 10 MFZ265 265VTP KZISZ-2	für / for: Euro2 Getriebeummer / Transmission Number: 2826.5 13017231	(68) (26)
40-10 V	01.85 - 12.89	8140.27S		3400 700 429 • 3482 907 001 • 1862 967 001 • 3151 065 031	265 10 MF265 265TB KZI-1	Nur zusammen verbauen / Only install together	(51)
45-10 V (10334204, 10334211, 10334212, 10334217, 10334404)	01.85 - 12.89	8140.21		3400 700 429 • 3482 907 001 • 1862 967 001 • 3151 065 031	265 10 MF265 265TB KZI-1	Getriebeummer / Transmission Number: 2824 10334204 / 10334211 / 10334212 / 10334217 / 10334404	(26)
49-10 V (10354204, 10354211, 10354212, 10354217...)	01.85 - 12.89	8140.21		3400 700 429 • 3482 907 001 • 1862 967 001 • 3151 065 031	265 10 MF265 265TB KZI-1	Getriebeummer / Transmission Number: 2822 10354204 / 10354211 / 10354212 / 10354217 / 10354404 / 10354411 / 10354412	(26)

DAILY I Pritsche / Flatbed 01.78 - 05.99

30-8 (10011131, 10011132, 10011231, 10011232, 10011237...)	01.78 - 12.89	8140.61		3000 434 001 • 1850 480 049 • 1862 977 001 • 3151 065 031	240 10 M240 240CB KZI-1	Getriebeummer / Transmission Number: 2815 10011131 / 10011132 / 10011231 / 10011232 / 10011237 / 10016132 / 10016232	(26)
35-8 (10031131, 10031132, 10031137, 10031224, 10031231...)	01.78 - 12.89	8140.61		3000 434 001 • 1850 480 049 • 1862 977 001 • 3151 065 031	240 10 M240 240CB KZI-1	Getriebeummer / Transmission Number: 2815 10031131 / 10031132 / 10031137 / 10031224 / 10031231 / 10031232 / 10031237 / 10031324 / 10031331 / 10031332 / 10031337 / 10036131 / 10036132 / 10036137 / 10036231 / 10036232 / 10036237	(26)
35-10 (10310311, 10311111, 10311112, 10311117, 10311211...)	01.85 - 12.89	8140.21		3400 700 429 • 3482 907 001 • 1862 967 001 • 3151 065 031	265 10 MF265 265TB KZI-1	Getriebeummer / Transmission Number: 2824 10310311	(26)
				3400 700 429 • 3482 907 001 • 1862 967 001 • 3151 065 031	265 10 MF265 265TB KZI-1	Getriebeummer / Transmission Number: 2822 10311111 / 10311112 / 10311117 / 10311211 / 10311212 / 10311217 / 10311304 / 10311311 / 10311312 / 10311317 / 10316211	(26)
40-8	01.83 - 06.89	8140.61.200		3000 434 001	240 10		



IVECO

DAILY I Pritsche / Flatbed 01.78 - 05.99						
40-10	01.85 - 12.89	8140.27S		3400 700 429 ⊗ 3482 907 001 ⊗ 1862 967 001 ⊙ 3151 065 031	265 10 MF265 265TB KZI-1	Nur zusammen verbauen / Only install together (51)
45-10 (10331211, 10331212, 10331217, 10331304, 10331311...)	01.85 - 12.89	8140.21		3400 700 429 ⊗ 3482 907 001 ⊗ 1862 967 001 ⊙ 3151 065 031	265 10 MF265 265TB KZI-1	Getriebeummer / Transmission Number: 2824 10331217 / 10331304 / 10331311 / 10331312 / 10331317 / 10331211 / 10331212 (26)
49-10 (10350211, 10350304, 10350311, 10350404, 10350411...)	01.85 - 12.89	8140.21		3400 700 429 ⊗ 3482 907 001 ⊗ 1862 967 001 ⊙ 3151 065 031	265 10 MF265 265TB KZI-1	Getriebeummer / Transmission Number: 2822 10350211 / 10350304 / 10350311 / 10350404 / 10350411 / 10351211 / 10351212 / 10351215 / 10351217 / 10351304 / 10351311 / 10351312 / 10351317 (26)

DAILY II Kasten / Box 01.89 - 05.99							
30-8 (12914111, 12914112, 12914117, 12914131, 12914137...), 55 kW	01.89 - 08.98	8140.67F		3000 951 026 ⊗ 3083 039 031 ⊗ 1878 002 072 ⊙ 3151 600 529	235 10 MFZ235X 235VTB KZISZ-2	Getriebeummer / Transmission Number: 2826.5 14914111 / 14914117 / 14914211 / 14914217 / 14915111 / 14915211 (26)	
30-8 (12914111, 12914112, 12914117, 12914131, 12914137...), 55 kW	01.89 - 08.98	8140.07		3000 951 026 ⊗ 3083 039 031 ⊗ 1878 002 072 ⊙ 3151 600 529	235 10 MFZ235X 235VTB KZISZ-2	Getriebeummer / Transmission Number: 2819.5 12914137 / 12914235 / 12915135 (26)	
30-8 (12914111, 12914112, 12914117, 12914131, 12914137...), 60 kW	01.89 - 08.98			3000 434 001 ⊗ 1850 480 049 ⊗ 1862 977 001 ⊙ 3151 065 031	240 10 M240 240CB KZI-1	Getriebeummer / Transmission Number: 2819.5 12914215 (26)	
30-8 (12914111, 12914112, 12914117, 12914131, 12914137...), 60 kW	01.89 - 08.98			3000 434 001 ⊗ 1850 480 049 ⊗ 1862 977 001 ⊙ 3151 065 031	240 10 M240 240CB KZI-1	->Chass. 2926609 Getriebeummer / Transmission Number: 2819.5 12914111 / 12914112 / 12914117 / 12914131 / 12914211 / 12914212 / 12914217 / 12914231 / 12915111 / 12915112 / 12915131 / 12915211 / 12915212 / 12915231 (26)	
				3000 951 026 ⊗ 3083 039 031 ⊗ 1878 002 072 ⊙ 3151 600 529	235 10 MFZ235X 235VTB KZISZ-2	Chass. 2926610-> Getriebeummer / Transmission Number: 2819.5 12914111 / 12914112 / 12914117 / 12914131 / 12914211 / 12914212 / 12914217 / 12914231 / 12915111 / 12915112 / 12915131 / 12915211 / 12915212 / 12915231 (26)	
30-8 (14914111, 14914117, 14914211, 14914217, 14915111...), 60 kW	01.89 - 08.98		8140.67F		3000 951 026 ⊗ 3083 039 031 ⊗ 1878 002 072 ⊙ 3151 600 529	235 10 MFZ235X 235VTB KZISZ-2	Getriebeummer / Transmission Number: 2826.5 14914111 / 14914117 / 14914211 / 14914217 / 14915111 / 14915211 (26)
30-8 (14914111, 14914117, 14914211, 14914217, 14915111...), 62 kW	09.98 - 05.99						
30-8 V (14914111, 14914117, 14914211, 14914217...)	09.98 - 05.99						
30-10	01.97 - 05.99	8140.23.		3400 700 444 ■	265 10	15011131 / 15011231 / 15014131 / 15014231 / 15015131 / 15015231	
30-10 C	01.97 - 05.99			3000 951 026 ⊗ 3083 039 031 ⊗ 1878 002 072 ⊙ 3151 600 529	235 10 MFZ235X 235VTB KZISZ-2	Nabenprofil / Hub Profile: 23x29,2x10Z (46)	
30-10 C	01.97 - 05.99					15014111 / 15014211 / 15015111 / 15015211	
35-8 (12934104, 12934111, 12934112, 12934117, 12934124...), 55 kW	01.91 - 08.98	8140.67F		3000 951 026 ⊗ 3083 039 031 ⊗ 1878 002 072 ⊙ 3151 600 529	235 10 MFZ235X 235VTB KZISZ-2	Getriebeummer / Transmission Number: 2826.5 14934104 / 14934111 / 14934204 / 14934205 / 14934211 / 14934212 / 14934215 / 14934217 / 14935211 / 14935215 (26)	
35-8 (12934104, 12934111, 12934112, 12934117, 12934124...), 55 kW	01.91 - 08.98	8140.07		3000 951 026 ⊗ 3083 039 031 ⊗ 1878 002 072 ⊙ 3151 600 529	235 10 MFZ235X 235VTB KZISZ-2	Getriebeummer / Transmission Number: 2819.5 12934124 / 12934224 / 12934235 / 12934237 / 12935235 / 12935237 (26)	
35-8 (12934104, 12934111, 12934112, 12934117, 12934124...), 60 kW	01.91 - 08.98			3000 434 001 ⊗ 1850 480 049 ⊗ 1862 977 001 ⊙ 3151 065 031	240 10 M240 240CB KZI-1	Getriebeummer / Transmission Number: 2819.5 12934205 / 12935215 (26)	
35-8 (12934104, 12934111, 12934112, 12934117, 12934124...), 60 kW	01.91 - 08.98			3000 434 001 ⊗ 1850 480 049 ⊗ 1862 977 001 ⊙ 3151 065 031	240 10 M240 240CB KZI-1	->Chass. 2926609 Getriebeummer / Transmission Number: 2819.5 12934104 / 12934111 / 12934112 / 12934117 / 12934131 / 12934204 / 12934211 / 12934212 / 12934215 / 12934217 / 12934231 / 12935211 / 12935212 / 12935217 / 12935231 (26)	
35-8 (12934104, 12934111, 12934112, 12934117, 12934124...), 60 kW	01.91 - 08.98			3000 951 026 ⊗ 3083 039 031 ⊗ 1878 002 072 ⊙ 3151 600 529	235 10 MFZ235X 235VTB KZISZ-2	Chass. 2926610-> Getriebeummer / Transmission Number: 2819.5 12934104 / 12934111 / 12934112 / 12934117 / 12934131 / 12934204 / 12934211 / 12934212 / 12934215 / 12934217 / 12934231 / 12935211 / 12935212 / 12935217 / 12935231 (26)	

















IVECO

DAILY II Kasten / Box		01.89 - 05.99					
35-8 (14934104, 14934111, 14934204, 14934205, 14934211...)	09.98 - 05.99	8140.67F	3000 951 026 ⊗ 3083 039 031 ⊗ 1878 002 072 ⊙ 3151 600 529	235 10 MFZ235X 235VTB KZISZ-2	Getriebeummer / Transmission Number: 2826.5 14934104 / 14934111 / 14934204 / 14934205 / 14934211 / 14934212 / 14934215 / 14934217 / 14935211 / 14935215	(26)	
35-10 (12974212, 12974217, 12974417)	09.96 - 08.98	8140.97	3000 951 026 ⊗ 3083 039 031 ⊗ 1878 002 072 ⊙ 3151 600 529	235 10 MFZ235X 235VTB KZISZ-2	Getr. / GBox: 2826.5 12974212 / 12974217		
35-10 (12974212, 12974217, 13014111, 13014131, 13014204...), 76 kW 35-10 (12974212, 12974217, 13014111, 13014131, 13014204...), 80 kW	01.89 - 08.98	8140.47R	3400 700 432 ■	280 10 280/Z	Getriebeummer / Transmission Number: 2826.5 15534211 / 15534212 / 15534217 / 15534411 / 15534417 / 15535212 Nabenprofil / Hub Profile: 23x30,55x10Z	(26)	(46)
			3400 117 701 ⊗ 3482 998 701 ⊗ 1878 997 101 ⊙ 3151 600 529	265 10 MFZ265 265VTP KZISZ-2	Getriebeummer / Transmission Number: 2826.5 13810217 / 13810417 / 13814212 / 13814217 / 13814412 / 13814417 / 13815212 / 13817212	(26)	
		8140.97	3000 951 026 ⊗ 3083 039 031 ⊗ 1878 002 072 ⊙ 3151 600 529	235 10 MFZ235X 235VTB KZISZ-2	Getriebeummer / Transmission Number: 2826.5 12974212 / 12974217	(26)	
		8140.23	3000 951 026 ⊗ 3083 039 031 ⊗ 1878 002 072 ⊙ 3151 600 529	235 10 MFZ235X 235VTB KZISZ-2	Getriebeummer / Transmission Number: 2826.5 15034111 / 15034204 / 15034211 / 15034215 / 15034217 / 15034404 / 15034411 / 15034417 / 15035211 / 15035217	(26)	
		8140.27S	3000 951 026 ⊗ 3083 039 031 ⊗ 1878 002 072 ⊙ 3151 600 529	235 10 MFZ235X 235VTB KZISZ-2	Getriebeummer / Transmission Number: 2826.5 13014131 / 13014224 / 13014231 / 13014233 / 13014235 / 13014237 / 13014424 / 13014431 / 13014437 / 13015231 / 13015235 / 13015237	(26)	
			3400 117 701 ⊗ 3482 998 701 ⊗ 1878 997 101 ⊙ 3151 600 529	265 10 MFZ265 265VTP KZISZ-2	für / for: Euro2 Getriebeummer / Transmission Number: 2826.5 13014131 / 13014231 / 13014233 / 13014431 / 13015231	(68)	(26)
			3400 700 429 ⊗ 3482 907 001 ⊗ 1862 967 001 ⊙ 3151 065 031	265 10 MF265 265TB KZI-1	->Chass. 5928512 Getriebeummer / Transmission Number: 2826.5 13014111 / 13014204 / 13014211 / 13014212 / 13014213 / 13014215 / 13014217 / 13014404 / 13014411 / 13014412 / 13014417 / 13015211 / 13015212 / 13015217	(26)	
			3000 951 026 ⊗ 3083 039 031 ⊗ 1878 002 072 ⊙ 3151 600 529	235 10 MFZ235X 235VTB KZISZ-2	Chass. 5928513-> Getriebeummer / Transmission Number: 2826.5 13014111 / 13014204 / 13014211 / 13014212 / 13014213 / 13014215 / 13014217 / 13014404 / 13014411 / 13014412 / 13014417 / 13015211 / 13015212 / 13015217	(26)	
35-10 (15034111, 15034204, 15034211, 15034215, 15034217...)	01.96 - 05.99	8140.23	3000 951 026 ⊗ 3083 039 031 ⊗ 1878 002 072 ⊙ 3151 600 529	235 10 MFZ235X 235VTB KZISZ-2	Getriebeummer / Transmission Number: 2826.5 15034111 / 15034204 / 15034211 / 15034215 / 15034217 / 15034404 / 15034411 / 15034417 / 15035211 / 15035217	(26)	
			3400 700 444 ■	265 10	Getriebeummer / Transmission Number: 2826.5 15034131 / 15034224 / 15034231 / 15034424 / 15034431 Nabenprofil / Hub Profile: 23x29,2x10Z	(26)	(46)
35-12 (13114131, 13114204, 13114211, 13114212, 13114217...)	01.90 - 04.96	8140.43	3400 700 432 ■	280 10 280/Z	Getriebeummer / Transmission Number: 2826.5 15134204 / 15134211 / 15134217 / 15134404 / 15134411 / 15134417 / 15135211 / 15434211 / 15434411 / 15435211 Nabenprofil / Hub Profile: 23x30,55x10Z	(26)	(46)
		8140.47	3400 117 701 ⊗ 3482 998 701 ⊗ 1878 997 101 ⊙ 3151 600 529	265 10 MFZ265 265VTP KZISZ-2	Getriebeummer / Transmission Number: 2826.5 13114131 / 13114204 / 13114211 / 13114212 / 13114217 / 13114224 / 13114231 / 13114237 / 13114411 / 13114412 / 13114417 / 13114424 / 13114431 / 13114437 / 13115211 / 13115212 / 13115217 / 13115231	(26)	
40-10 V	01.90 - 04.96	8140	3000 951 026 ⊗ 3083 039 031 ⊗ 1878 002 072 ⊙ 3151 600 529	235 10 MFZ235X 235VTB KZISZ-2	03.1990->		
		8140.27.2720	3400 700 429 ⊗ 3482 907 001 ⊗ 1862 967 001 ⊙ 3151 065 031	265 10 MF265 265TB KZI-1	Nur zusammen verbauen / Only install together	(51)	
40-10 4x4 (15214104, 15214111, 15214117, 15215111)	01.97 - 05.99	8140.23	3000 951 026 ⊗ 3083 039 031 ⊗ 1878 002 072 ⊙ 3151 600 529	235 10 MFZ235X 235VTB KZISZ-2	Getriebeummer / Transmission Number: 2826.5 15214104 / 15214111 / 15214117 / 15215111	(26)	

		CODE				
--	--	------	--	---	---	---

IVECO













DAILY II Kasten / Box		01.89 - 05.99					
45-10 V (13034204, 13034211, 13034212, 13034224...)	01.89-04.96	8140.27S	 3000 951 026 ⊗ 3083 039 031 ⊗ 1878 002 072 ⊙ 3151 600 529	235 10 MFZ235X 235VTB KZISZ-2	Getriebeummer / Transmission Number: 2826.5 13034224 / 13034231 / 13034424 / 13034431	(26)	
			 3400 700 429 ⊗ 3482 907 001 ⊗ 1862 967 001 ⊙ 3151 065 031	265 10 MF265 265TB KZI-1	-> Chass. 5928512 Getriebeummer / Transmission Number: 2826.5 13034204 / 13034211 / 13034212 / 13034404 / 13034411 / 13034412	(26)	
			 3000 951 026 ⊗ 3083 039 031 ⊗ 1878 002 072 ⊙ 3151 600 529	235 10 MFZ235X 235VTB KZISZ-2	Chass. 5928513-> Getriebeummer / Transmission Number: 2826.5 13034204 / 13034211 / 13034212 / 13034404 / 13034411 / 13034412	(26)	
49-10 V (13054204, 13054211, 13054212, 13054215...)	01.89-04.96	8140.23	 3000 951 026 ⊗ 3083 039 031 ⊗ 1878 002 072 ⊙ 3151 600 529	235 10 MFZ235X 235VTB KZISZ-2	Getriebeummer / Transmission Number: 2826.5 15054204 / 15054211 / 15054215 / 15054217 / 15054404 / 15054411 / 15054417	(26)	
			8140.27S	 3000 951 026 ⊗ 3083 039 031 ⊗ 1878 002 072 ⊙ 3151 600 529	235 10 MFZ235X 235VTB KZISZ-2	Getriebeummer / Transmission Number: 2826.5 13054224 / 13054231 / 13054235 / 13054237 / 13054424 / 13054431 / 13054437	(26)
		 3400 117 701 ⊗ 3482 998 701 ⊗ 1878 997 101 ⊙ 3151 600 529		265 10 MFZ265 265VTP KZISZ-2	für / for: Euro2 Getriebeummer / Transmission Number: 2826.5 13054231 / 13054431	(68) (26)	
		 3400 700 429 ⊗ 3482 907 001 ⊗ 1862 967 001 ⊙ 3151 065 031		265 10 MF265 265TB KZI-1	-> Chass. 5928512 Getriebeummer / Transmission Number: 2826.5 13054204 / 13054211 / 13054212 / 13054215 / 13054217 / 13054404 / 13054411 / 13054412 / 13054417	(26)	
		 3000 951 026 ⊗ 3083 039 031 ⊗ 1878 002 072 ⊙ 3151 600 529	235 10 MFZ235X 235VTB KZISZ-2	Chass. 5928513-> Getriebeummer / Transmission Number: 2826.5 13054204 / 13054211 / 13054212 / 13054215 / 13054217 / 13054404 / 13054411 / 13054412 / 13054417	(26)		
49-12 V (13134124, 13134204, 13134211, 13134212...)	06.90-04.96	8140.47	 3400 117 701 ⊗ 3482 998 701 ⊗ 1878 997 101 ⊙ 3151 600 529	265 10 MFZ265 265VTP KZISZ-2	Getriebeummer / Transmission Number: 2826.5 13134435 / 13134437 / 13134124 / 13134204 / 13134211 / 13134212 / 13134217 / 13134224 / 13134231 / 13134235 / 13134237 / 13134404 / 13134411 / 13134412 / 13134417 / 13134424 / 13134431	(26)	
49-12 V (15154204, 15154211, 15154215, 15154217...)	05.96-05.99	8140.43	 3400 700 432 ■	280 10 280/Z	Getriebeummer / Transmission Number: 2826.5 15154204 / 15154211 / 15154215 / 15154217 / 15154404 / 15154411 / 15154417 Nabenprofil / Hub Profile: 23x30,55x10Z	(26) (46)	
59-12 V (13154404, 13154411, 13154412, 13154417...)	05.91-04.96	8140.47	 3400 117 701 ⊗ 3482 998 701 ⊗ 1878 997 101 ⊙ 3151 600 529	265 10 MFZ265 265VTP KZISZ-2	Getriebeummer / Transmission Number: 2826.5 13154404 / 13154411 / 13154412 / 13154417 / 13154424 / 13154431 / 13154435 / 13154437	(26)	
59-12 V (15174404, 15174411, 15174415, 15174417)	05.96-05.99	8140.43	 3400 700 432 ■	280 10 280/Z	Getriebeummer / Transmission Number: 2826.5 15174404 / 15174411 / 15174415 / 15174417 Nabenprofil / Hub Profile: 23x30,55x10Z	(26) (46)	

DAILY II Kipper / Dumptruck		01.89 - 05.99					
35-8 K (14930304, 14931104, 14931111, 14931115...)	09.98-05.99	8140.67	 3000 951 026 ⊗ 3083 039 031 ⊗ 1878 002 072 ⊙ 3151 600 529	235 10 MFZ235X 235VTB KZISZ-2	Getriebeummer / Transmission Number: 2826.5 14930304 / 14931104 / 14931111 / 14931115 / 14931204 / 14931211 / 14931215 / 14931217 / 14931304 / 14931311 / 14931317 / 14931411 / 15931111	(26)	
35-10 K (15030111, 15030211, 15030311, 15031111...)	01.97-05.99	8140.23	 3000 951 026 ⊗ 3083 039 031 ⊗ 1878 002 072 ⊙ 3151 600 529	235 10 MFZ235X 235VTB KZISZ-2	Getriebeummer / Transmission Number: 2826.5 15030111 / 15030211 / 15030311 / 15031111 / 15031117 / 15031204 / 15031211 / 15031215 / 15031217 / 15031304 / 15031311 / 15031317 / 15031411 / 15036111 / 15036204 / 15036211 / 15036215 / 15036217 / 15036311	(26)	
35-12 K (15130311, 15130411, 15131111, 15131204...)	09.96-08.98	8140.43	 3400 700 432 ■	280 10 280/Z	Getriebeummer / Transmission Number: 2826.5 15130311 / 15130411 / 15131111 / 15131204 / 15131211 / 15131217 / 15131304 / 15131311 / 15131317 / 15131411 / 15131417 / 15136111 / 15136211 / 15136311 / 15136317 Nabenprofil / Hub Profile: 23x30,55x10Z	(26) (46)	





		CODE				
--	--	------	--	---	---	---

IVECO

DAILY II Kipper / Dumptruck 01.89 - 05.99











45-10 (13031204, 13031211, 13031212, 13031224, 13031231...)	01.92-04.96	8140.27S	 3000 951 026 ⊗ 3083 039 031 ⊗ 1878 002 072 ⊙ 3151 600 529	235 10 MFZ235X 235VTB KZISZ-2	Getriebeummer / Transmission Number: 2826.5 13031224 / 13031231 / 13031324 / 13031331	(26)
			 3400 700 429 ⊗ 3482 907 001 ⊗ 1862 967 001 ⊙ 3151 065 031	265 10 MF265 265TB KZI-1	->Chass. 5928512 Getriebeummer / Transmission Number: 2826.5 13031211 / 13031212 / 13031304 / 13031311 / 13031312 / 13031204	(26)
			 3000 951 026 ⊗ 3083 039 031 ⊗ 1878 002 072 ⊙ 3151 600 529	235 10 MFZ235X 235VTB KZISZ-2	Chass. 5928513-> Getriebeummer / Transmission Number: 2826.5 13031211 / 13031212 / 13031304 / 13031311 / 13031312 / 13031204	(26)
49-10 K (13056212, 13056224, 13056231, 13056237...)	01.89-04.96	8140.27S	 3000 951 026 ⊗ 3083 039 031 ⊗ 1878 002 072 ⊙ 3151 600 529	235 10 MFZ235X 235VTB KZISZ-2	Getriebeummer / Transmission Number: 2826.5 13056224 / 13056231 / 13056237 / 13056304 / 13056324 / 13056331	(26)
			 3400 117 701 ⊗ 3482 998 701 ⊗ 1878 997 101 ⊙ 3151 600 529	265 10 MFZ265 265VTP KZISZ-2	für / for: Euro2 Getriebeummer / Transmission Number: 2826.5 13056231 / 13056331	(68) (26)
			 3400 700 429 ⊗ 3482 907 001 ⊗ 1862 967 001 ⊙ 3151 065 031	265 10 MF265 265TB KZI-1	->Chass. 5928512 Getriebeummer / Transmission Number: 2826.5 13056212 / 13056312	(26)
			 3000 951 026 ⊗ 3083 039 031 ⊗ 1878 002 072 ⊙ 3151 600 529	235 10 MFZ235X 235VTB KZISZ-2	Chass. 5928513-> Getriebeummer / Transmission Number: 2826.5 13056212 / 13056312	(26)
49-10 K (15056204, 15056211, 15056304, 15056311)	05.96-05.99	8140.23	 3000 951 026 ⊗ 3083 039 031 ⊗ 1878 002 072 ⊙ 3151 600 529	235 10 MFZ235X 235VTB KZISZ-2	Getriebeummer / Transmission Number: 2826.5 15056204 / 15056211 / 15056304 / 15056311	(26)
		8140.23.	 3400 700 444 ■	265 10	15050424 / 15050431 / 15051224 / 15051231 / 15051324 / 15051331 / 15051424 / 15051431 / 15051524 / 15051531 / 15054224 / 15054231 / 15054424 / 15054431 / 15056224 / 15056231 / 15056324 / 15056331 Nabenprofil / Hub Profile: 23x29,2x10Z	(46)
49-12 K (13136204, 13136211, 13136212, 13136224...)	06.90-04.96	8140.47	 3400 117 701 ⊗ 3482 998 701 ⊗ 1878 997 101 ⊙ 3151 600 529	265 10 MFZ265 265VTP KZISZ-2	Getriebeummer / Transmission Number: 2826.5 13136204 / 13136211 / 13136212 / 13136224 / 13136231 / 13136237 / 13136312 / 13136324 / 13136331 / 13136337	(26)
59-12 K (13156211, 13156212, 13156231, 13156311...)	05.91-04.96	8140.47	 3400 117 701 ⊗ 3482 998 701 ⊗ 1878 997 101 ⊙ 3151 600 529	265 10 MFZ265 265VTP KZISZ-2	Getriebeummer / Transmission Number: 2826.5 13156331 / 13156335 / 13156337 / 13156512 / 13156531 / 13156211 / 13156212 / 13156231 / 13156311 / 13156312 / 13156324	(26)
59-12 K (15176211, 15176304, 15176311, 15176315...)	05.96-05.99	8140.43	 3400 700 432 ■	280 10 280/Z	Getriebeummer / Transmission Number: 2826.5 15176211 / 15176304 / 15176311 / 15176315 / 15176317 / 15176511 Nabenprofil / Hub Profile: 23x30,55x10Z	(26) (46)

DAILY II Pritsche / Flatbed 01.89 - 05.99

30-8 (12910211, 12911111, 12911112, 12911117, 12911131...), 55 kW	01.92-08.98	8140.67F	 3000 951 026 ⊗ 3083 039 031 ⊗ 1878 002 072 ⊙ 3151 600 529	235 10 MFZ235X 235VTB KZISZ-2	Getriebeummer / Transmission Number: 2826.5 14911111 / 14911117 / 14911211 / 14911215 / 14911217 / 14916111 / 14916211	(26)
	01.92-08.98	8140.07	 3000 951 026 ⊗ 3083 039 031 ⊗ 1878 002 072 ⊙ 3151 600 529	235 10 MFZ235X 235VTB KZISZ-2	Getriebeummer / Transmission Number: 2819.5 12911235 / 12911237 / 12916135 / 12916235	(26)
	01.92-08.98		 3000 434 001 ⊗ 1850 480 049 ⊗ 1862 977 001 ⊙ 3151 065 031	240 10 M240 240CB KZI-1	->Chass. 2926609 Getriebeummer / Transmission Number: 2819.5 12910211 / 12911111 / 12911112 / 12911117 / 12911131 / 12911211 / 12911212 / 12911217 / 12911231 / 12916112 / 12916131 / 12916212 / 12916231	(26)
	01.92-08.98		 3000 951 026 ⊗ 3083 039 031 ⊗ 1878 002 072 ⊙ 3151 600 529	235 10 MFZ235X 235VTB KZISZ-2	Chass. 2926610-> Getriebeummer / Transmission Number: 2819.5 12910211 / 12911111 / 12911112 / 12911117 / 12911131 / 12911211 / 12911212 / 12911217 / 12911231 / 12916112 / 12916131 / 12916212 / 12916231	(26)















		CODE				
--	--	------	--	---	---	---

IVECO

DAILY II Pritsche / Flatbed 01.89 - 05.99							
30-8 (10011131, 10011132, 10011231, 10011232, 10011237...), 60 kW	01.92 - 08.98	8140.61		3000 434 001 ⊕ 1850 480 049 ⊕ 1862 977 001 ⊕ 3151 065 031	240 10 M240 240CB KZI-1	Getriebeummer / Transmission Number: 2815 10011131 / 10011132 / 10011231 / 10011232 / 10011237 / 10016132 / 10016232	(26)
	09.98 - 05.99	8140.67F		3000 951 026 ⊕ 3083 039 031 ⊕ 1878 002 072 ⊕ 3151 600 529	235 10 MFZ235X 235VTB KZISZ-2	Getriebeummer / Transmission Number: 2826.5 14911111 / 14911117 / 14912111 / 14911215 / 14911217 / 14916111 / 14916211	(26)
30-8 (14911111, 14911117, 14911211, 14911215, 14911217...)	09.98 - 05.99	8140.67F		3000 951 026 ⊕ 3083 039 031 ⊕ 1878 002 072 ⊕ 3151 600 529	235 10 MFZ235X 235VTB KZISZ-2	Getriebeummer / Transmission Number: 2826.5 14911111 / 14911117 / 14912111 / 14911215 / 14911217 / 14916111 / 14916211	(26)
30-10	01.98 - 05.99	8140.23.		3400 700 444 ■	265 10	15011131 / 15011231 / 15014131 / 15014231 / 15015131 / 15015231 Nabenprofil / Hub Profile: 23x29,2x10Z	(46)
				3000 951 026 ⊕ 3083 039 031 ⊕ 1878 002 072 ⊕ 3151 600 529	235 10 MFZ235X 235VTB KZISZ-2	15014111 / 15014211 / 15015111 / 15015211	
35-8 (12931102, 12931104, 12931111, 12931112, 12931117...), 55 kW 35-8 (12931102, 12931104, 12931111, 12931112, 12931117...), 55 kW 35-8 (12931102, 12931104, 12931111, 12931112, 12931117...), 60 kW 35-8 (12931102, 12931104, 12931111, 12931112, 12931117...), 60 kW	01.89 - 08.98	8140.67		3000 951 026 ⊕ 3083 039 031 ⊕ 1878 002 072 ⊕ 3151 600 529	235 10 MFZ235X 235VTB KZISZ-2	Getriebeummer / Transmission Number: 2826.5 14930304 / 14931104 / 14931111 / 14931115 / 14931204 / 14931211 / 14931215 / 14931217 / 14931304 / 14931311 / 14931317 / 14931411 / 14936111 / 14936204 / 14936211 / 14936215 / 14936217 / 15931111	(26)
	01.89 - 08.98	8140.07		3000 951 026 ⊕ 3083 039 031 ⊕ 1878 002 072 ⊕ 3151 600 529	235 10 MFZ235X 235VTB KZISZ-2	Getriebeummer / Transmission Number: 2819.5 12931124 / 12936135 / 12936235 / 12936237 / 12931135 / 12931205 / 12931224 / 12931235 / 12931324 / 12931335 / 12931337 / 12931412	(26)
	01.89 - 08.98			3000 434 001 ⊕ 1850 480 049 ⊕ 1862 977 001 ⊕ 3151 065 031	240 10 M240 240CB KZI-1	->Chass. 2926609 Getriebeummer / Transmission Number: 2819.5 12931102 / 12931104 / 12931111 / 12931112 / 12931117 / 12931131 / 12931431 / 12936111 / 12936112 / 12936117 / 12936131 / 12936211 / 12936212 / 12936217 / 12936231 / 12931202 / 12931204 / 12931211 / 12931212 / 12931215 / 12931217 / 12931231 / 12931304 / 12931305 / 12931311 / 12931312 / 12931317 / 12931331	(26)
	01.89 - 08.98			3000 951 026 ⊕ 3083 039 031 ⊕ 1878 002 072 ⊕ 3151 600 529	235 10 MFZ235X 235VTB KZISZ-2	Chass. 2926610-> Getriebeummer / Transmission Number: 2819.5 12931102 / 12931104 / 12931111 / 12931112 / 12931117 / 12931131 / 12931431 / 12936111 / 12936112 / 12936117 / 12936131 / 12936211 / 12936212 / 12936217 / 12936231 / 12931202 / 12931204 / 12931211 / 12931212 / 12931215 / 12931217 / 12931231 / 12931304 / 12931305 / 12931311 / 12931312 / 12931317 / 12931331	(26)
35-8 (14930304, 14931104, 14931111, 14931115, 14931204...)	09.98 - 05.99	8140.67		3000 951 026 ⊕ 3083 039 031 ⊕ 1878 002 072 ⊕ 3151 600 529	235 10 MFZ235X 235VTB KZISZ-2	Getriebeummer / Transmission Number: 2826.5 14930304 / 14931104 / 14931111 / 14931115 / 14931204 / 14931211 / 14931215 / 14931217 / 14931304 / 14931311 / 14931317 / 14931411 / 14936111 / 14936204 / 14936211 / 14936215 / 14936217	(26)















		CODE				
--	--	------	--	---	---	---

IVECO

DAILY II Pritsche / Flatbed 01.89 - 05.99							
35-10 (12971112, 12971212, 12971312, 12971317, 12976112...), 68 kW	01.89 - 12.96	8140.47R		3400 117 701 ⊗ 3482 998 701 ⊗ 1878 997 101 ⬤ 3151 600 529	265 10 MFZ265 265VTP KZISZ-2	Getriebeummer / Transmission Number: 2826.5 13810312 / 13811112 / 13811212 / 13811217 / 13811312 / 13811317 / 13816112 / 13816212 / 13816217	(26)
	35-10 (12971112, 12971212, 12971312, 12971317, 12976112...), 76 kW	01.89 - 12.96	8140.97		3400 117 701 ⊗ 3482 998 701 ⊗ 1878 997 101 ⬤ 3151 600 529	265 10 MFZ265 265VTP KZISZ-2	Getriebeummer / Transmission Number: 2826.5 12976112
				3000 951 026 ⊗ 3083 039 031 ⊗ 1878 002 072 ⬤ 3151 600 529	235 10 MFZ235X 235VTB KZISZ-2	Getriebeummer / Transmission Number: 2826.5 12971112 / 12971212 / 12971312 / 12971317 / 12976212	(26)
8140.25S			3000 951 026 ⊗ 3083 039 031 ⊗ 1878 002 072 ⬤ 3151 600 529	235 10 MFZ235X 235VTB KZISZ-2	Getriebeummer / Transmission Number: 2826.5 13011137	(26)	
8140.27S			3000 951 026 ⊗ 3083 039 031 ⊗ 1878 002 072 ⬤ 3151 600 529	235 10 MFZ235X 235VTB KZISZ-2	Getriebeummer / Transmission Number: 2826.5 13010131 / 13010231 / 13010331 / 13010431 / 13011131 / 13011135 / 13011224 / 13011231 / 13011235 / 13011237 / 13011315 / 13011324 / 13011331 / 13011337 / 13011412 / 13011431 / 13016131 / 13016135 / 13016231 / 13016235 / 13016237	(26)	
			3400 117 701 ⊗ 3482 998 701 ⊗ 1878 997 101 ⬤ 3151 600 529	265 10 MFZ265 265VTP KZISZ-2	für / for: Euro2 Getriebeummer / Transmission Number: 2826.5 13010131 / 13010231 / 13010331 / 13010431 / 13011131 / 13011231 / 13011331 / 13011431 / 13016131 / 13016231	(68) (26)	
			3400 700 429 ⊗ 3482 907 001 ⊗ 1862 967 001 ⬤ 3151 065 031	265 10 MF265 265TB KZI-1	->Chass. 5928512 Getriebeummer / Transmission Number: 2826.5 13010211 / 13010217 / 13010311 / 13010411 / 13010417 / 13011111 / 13011112 / 13011115 / 13011117 / 13011204 / 13011211 / 13011212 / 13011215 / 13011217 / 13011304 / 13011311 / 13011312 / 13011317 / 13016111 / 13016112 / 13016115 / 13016117 / 13016211 / 13016212 / 13016215 / 13016217	(26)	
			3000 951 026 ⊗ 3083 039 031 ⊗ 1878 002 072 ⬤ 3151 600 529	235 10 MFZ235X 235VTB KZISZ-2	Chass. 5928513-> Getriebeummer / Transmission Number: 2826.5 13010211 / 13010217 / 13010311 / 13010411 / 13010417 / 13011111 / 13011112 / 13011115 / 13011117 / 13011204 / 13011211 / 13011212 / 13011215 / 13011217 / 13011304 / 13011311 / 13011312 / 13011317 / 13016111 / 13016112 / 13016115 / 13016117 / 13016211 / 13016212 / 13016215 / 13016217	(26)	
35-10	01.89 - 12.96	8140.47R		3400 700 432 ■ 280/Z	280 10 280/Z	Getr. / GBox: 2826.5 Nabenprofil / Hub Profile: 23x30,55x10Z	(46)
35-10 (15030111, 15030211, 15030311, 15031111, 15031117...)	01.96 - 05.99	8140.23		3400 700 432 ■ 280/Z	280 10 280/Z	Getriebeummer / Transmission Number: 2826.5 15631231 Nabenprofil / Hub Profile: 23x30,55x10Z	(26) (46)
				3400 700 444 ■	265 10	Getriebeummer / Transmission Number: 2826.5 15030131 / 15030231 / 15030331 / 15030431 / 15031131 / 15031224 / 15031231 / 15031324 / 15031331 / 15031424 / 15031431 / 15036131 / 15036224 / 15036231 / 15036331 Nabenprofil / Hub Profile: 23x29,2x10Z	(26) (46)
				3000 951 026 ⊗ 3083 039 031 ⊗ 1878 002 072 ⬤ 3151 600 529	235 10 MFZ235X 235VTB KZISZ-2	Getriebeummer / Transmission Number: 2826.5 15030111 / 15030211 / 15030311 / 15030411 / 15031111 / 15031115 / 15031117 / 15031204 / 15031211 / 15031215 / 15031217 / 15031304 / 15031311 / 15031315 / 15031317 / 15031411 / 15036111 / 15036204 / 15036211 / 15036215 / 15036217 / 15036311 / 15631211	(26)
		8140.47R		3400 700 432 ■ 280/Z	280 10 280/Z	Getriebeummer / Transmission Number: 2826.5 15531211 / 15531217 / 15531317 Nabenprofil / Hub Profile: 23x30,55x10Z	(26) (46)
35-12 (13110131, 13110211, 13110231, 13110311, 13110312...)	01.90 - 04.96	8140.47		3400 117 701 ⊗ 3482 998 701 ⊗ 1878 997 101 ⬤ 3151 600 529	265 10 MFZ265 265VTP KZISZ-2	Getriebeummer / Transmission Number: 2826.5 13110131 / 13110211 / 13110231 / 13110311 / 13110312 / 13110331 / 13110411 / 13110412 / 13110431 / 13111111 / 13111112 / 13111117 / 13111131 / 13111204 / 13111211 / 13111212 / 13111217 / 13111224 / 13111231 / 13111304 / 13111311 / 13111312 / 13111317 / 13111324 / 13111331 / 13111337 / 13111411 / 13111412 / 13111417 / 13111431 / 13111437 / 13116111 / 13116112 / 13116131 / 13116211 / 13116212 / 13116231 / 13116237 / 13116312 / 13116331 / 13116337	(26)



		CODE				
--	--	------	--	---	---	---







































IVECO

DAILY II Pritsche / Flatbed 01.89 - 05.99						
35-12 (15130311, 15130411, 15131111, 15131204, 15131211...)	05.96 - 05.99	8140.43		3400 700 432 ■ ⊗ 3083 039 031 ⊗ 1878 002 072 ⊙ 3151 600 529	280 10 280/Z	Getriebeummer / Transmission Number: 2826.5 15130311 / 15130411 / 15131111 / 15131204 / 15131211 / 15131217 / 15131304 / 15131311 / 15131317 / 15131411 / 15131417 Nabenprofil / Hub Profile: 23x30,55x10Z (26)
45-10 (13031204, 13031211, 13031212, 13031224, 13031231...)	01.89 - 04.96	8140.27S		3000 951 026 ⊗ 3083 039 031 ⊗ 1878 002 072 ⊙ 3151 600 529	235 10 MFZ235X 235VTB KZISZ-2	Getriebeummer / Transmission Number: 2826.5 13031224 / 13031231 / 13031324 / 13031331 (26)
				3400 700 429 ⊗ 3482 907 001 ⊗ 1862 967 001 ⊙ 3151 065 031	265 10 MF265 265TB KZI-1	->Chass. 5928512 Getriebeummer / Transmission Number: 2826.5 13031211 / 13031212 / 13031304 / 13031311 / 13031312 / 13031204 (26)
				3000 951 026 ⊗ 3083 039 031 ⊗ 1878 002 072 ⊙ 3151 600 529	235 10 MFZ235X 235VTB KZISZ-2	Chass. 5928513-> Getriebeummer / Transmission Number: 2826.5 13031211 / 13031212 / 13031304 / 13031311 / 13031312 / 13031204 (26)
49-10 (13050211, 13050231, 13050304, 13050311, 13050331...)	01.89 - 04.96	8140.47R		3400 117 701 ⊗ 3482 998 701 ⊗ 1878 997 101 ⊙ 3151 600 529	265 10 MFZ265 265VTP KZISZ-2	Getriebeummer / Transmission Number: 2826.5 13851212 (26)
		8140.27S		3000 951 026 ⊗ 3083 039 031 ⊗ 1878 002 072 ⊙ 3151 600 529	235 10 MFZ235X 235VTB KZISZ-2	Getriebeummer / Transmission Number: 2826.5 13050231 / 13050331 / 13050415 / 13050424 / 13050431 / 13050435 / 13051224 / 13051231 / 13051235 / 13051237 / 13051324 / 13051331 / 13051335 / 13051337 / 13051531 / 13056224 / 13056231 / 13056237 / 13056304 / 13056324 / 13056331 (26)
				3400 117 701 ⊗ 3482 998 701 ⊗ 1878 997 101 ⊙ 3151 600 529	265 10 MFZ265 265VTP KZISZ-2	für / for: Euro2 Getriebeummer / Transmission Number: 2826.5 13050231 / 13050331 / 13050431 / 13051231 / 13051331 / 13051531 / 13056231 / 13056331 (68) (26)
				3400 700 429 ⊗ 3482 907 001 ⊗ 1862 967 001 ⊙ 3151 065 031	265 10 MF265 265TB KZI-1	->Chass. 5928512 Getriebeummer / Transmission Number: 2826.5 13050211 / 13050304 / 13050311 / 13050404 / 13050411 / 13051204 / 13051211 / 13051212 / 13051215 / 13051217 / 13051304 / 13051311 / 13051312 / 13051315 / 13051317 / 13056212 / 13056312 (26)
				3000 951 026 ⊗ 3083 039 031 ⊗ 1878 002 072 ⊙ 3151 600 529	235 10 MFZ235X 235VTB KZISZ-2	Chass. 5928513-> Getriebeummer / Transmission Number: 2826.5 13050211 / 13050304 / 13050311 / 13050404 / 13050411 / 13051204 / 13051211 / 13051212 / 13051215 / 13051217 / 13051304 / 13051311 / 13051312 / 13051315 / 13051317 / 13056212 / 13056312 (26)
49-10 (15050304, 15050404, 15050411, 15051204, 15051211...)	05.96 - 05.99	8140.23		3000 951 026 ⊗ 3083 039 031 ⊗ 1878 002 072 ⊙ 3151 600 529	235 10 MFZ235X 235VTB KZISZ-2	Getriebeummer / Transmission Number: 2826.5 15056204 / 15056211 / 15056304 / 15056311 / 15050304 / 15050404 / 15050411 / 15051204 / 15051211 / 15051215 / 15051217 / 15051304 / 15051304 / 15051311 / 15051315 / 15051317 / 15051411 / 15051511 (26)
		8140.23.		3400 700 444 ■	265 10	15050424 / 15050431 / 15051224 / 15051231 / 15051324 / 15051331 / 15051424 / 15051431 / 15051524 / 15051531 / 15054224 / 15054231 / 15054424 / 15054431 / 15056224 / 15056231 / 15056324 / 15056331 Nabenprofil / Hub Profile: 23x29,2x10Z (46)
49-12 (13130211, 13130231, 13130304, 13130311, 13130312...)	06.90 - 04.96	8140.47		3400 117 701 ⊗ 3482 998 701 ⊗ 1878 997 101 ⊙ 3151 600 529	265 10 MFZ265 265VTP KZISZ-2	Getriebeummer / Transmission Number: 2826.5 13136204 / 13136211 / 13136212 / 13136224 / 13136231 / 13136237 / 13136312 / 13136324 / 13136331 / 13136337 / 13130211 / 13130231 / 13130304 / 13130311 / 13130312 / 13130324 / 13130331 / 13130404 / 13130411 / 13130412 / 13130424 / 13130431 / 13131204 / 13131211 / 13131212 / 13131217 / 13131224 / 13131231 / 13131237 / 13131304 / 13131311 / 13131312 / 13131317 / 13131324 / 13131331 / 13131337 / 13131412 / 13131431 / 13131511 / 13131512 / 13131531 / 13131537 (26)
49-12 (15150211, 15150311, 15150404, 15150411, 15151204...)	05.96 - 05.99	8140.43		3400 700 432 ■ ⊗ 3083 039 031 ⊗ 1878 002 072 ⊙ 3151 600 529	280 10 280/Z	Getriebeummer / Transmission Number: 2826.5 15150211 / 15150311 / 15150404 / 15150411 / 15151204 / 15151211 / 15151304 / 15151311 / 15151317 / 15151411 / 15151511 / 15151517 / 15156211 / 15156304 / 15156311 / 15156317 Nabenprofil / Hub Profile: 23x30,55x10Z (46)
59-12 (13150204, 13150211, 13150231, 13150311, 13150312...)	05.91 - 04.96	8140.47		3400 117 701	265 10	Getriebeummer / Transmission Number: 2826.5 13150204 / 13150211 / 13150231 / 13150311 / 13150312 / 13150331 / 13150504 / 13150511 / (26)

		CODE				
--	--	-------------	--	---	---	---



IVECO

















DAILY II Pritsche / Flatbed 01.89 - 05.99						
59-12 (15170211, 15170304, 15170311, 15170504, 15170511...)	05.96 - 05.99	8140.43		3400 700 432 	280 10 280/Z	Getriebenummer / Transmission Number: 2826.5 15170211 / 15170304 / 15170311 / 15170504 / 15170511 / 15171204 / 15171211 / 15171215 / 15171217 / 15171304 / 15171311 / 15171315 / 15171317 / 15171511 / 15171517 / 15176211 / 15176304 / 15176311 / 15176315 / 15176317 / 15176511 Nabenprofil / Hub Profile: 23x30,55x10Z (26) (46)

DAILY III Kasten / Box 05.99 -							
29 L 9 V 29 L 11 V	05.99 - 05.99 -	8140.63., 8140.43C		3000 951 026  3083 039 031  1878 002 072  3151 600 529	235 10 MFZ235X 235VTB KZISZ-2		
29 L 10 V (ALJA43A2, ALJA42A2, ALJA41A2) 29 L 12 V (ALKA41A2, ALLA52A2, ALKA42A2)	09.02 - 09.02 -	F1AE0481B, F1AE0481A		3400 700 514 	280 10	XTend Getr. / GBox: ZF 6S-300A Nabenprofil / Hub Profile: 23x29-10N Nur zusammen verbauen / Only install together (46) (51)	
				6594 000 054	280 280Z	Getr. / GBox: ZF 6S-300A	
				3400 700 433 	235 10	Getr. / GBox: ZF S5-200 Nabenprofil / Hub Profile: 23,1x29,2x10Z (46)	
29 L 14	01.05 - 04.06	F1AE0481M		3400 700 514 	280 10	XTend Getr. / GBox: ZF 6S-400A OD Nabenprofil / Hub Profile: 23x29-10N Nur zusammen verbauen / Only install together (46) (51)	
				6594 000 054	280 280Z	->Mot. 635746 Getr. / GBox: ZF 6S-400A OD	
				3400 700 433 	235 10	Getr. / GBox: ZF 5S-300 Nabenprofil / Hub Profile: 23,1x29,2x10Z je nach Ausführung, mit unterschiedlicher Kupplung / depending on version, with different clutch (46) (85)	
				3400 700 483	267 10	Getr. / GBox: ZF 5S-300 Nabenprofil / Hub Profile: 23,05x30,57x10Z je nach Ausführung, mit unterschiedlicher Kupplung / depending on version, with different clutch (46) (85)	
				6594 000 054	280 280Z	Getr. / GBox: ZF 5S-300	
35 C 12 V, 35 S 12 V (AGKA43A2, AGKB43A2, AGKB46A2...)	09.02 -	F1AE0481B		3400 700 514 	280 10	XTend Schaltgetriebe, automatisch betätigt / Automated Manual Transmission Nabenprofil / Hub Profile: 23x29-10N Nur zusammen verbauen / Only install together (55) (46) (51)	
				6594 000 054	280 280Z	nur als Ersatz für angegebene OE-Nr. / only for the listed OE-Numbers (100)	
		F1AE0481		3400 700 433 	235 10	Getr. / GBox: S5-200 AGKA43A2 / AGKB43A2 / AGKB46A2 / AGKC43A2 / AGKC46A2 / ANKA42A2 / ANKA43A2 / ANKA43AB / ANKAV1A1 / ANLA51A1 / ANLA52A2 / ANLC52A2 Nabenprofil / Hub Profile: 23,1x29,2x10Z (46)	
35 C 17, 35 S 17	01.05 - 04.06	F1CE0481B		3400 700 515 	280 10	XTend Getr. / GBox: 6S-380A OD Nabenprofil / Hub Profile: 23x29-10N Nur zusammen verbauen / Only install together (46) (51)	
				3400 700 448 	280 10 280/Z	Getr. / GBox: 6S-380 OD Nabenprofil / Hub Profile: 23x29-10N (46)	
35 S 9 V, 35 C 9 V	05.99 -	8140.43		3000 951 026  3083 039 031  1878 002 072  3151 600 529	235 10 MFZ235X 235VTB KZISZ-2	Getr. / GBox: S5.200	
35 S 10 (ANJA41A1, ANJA42A2, ANJA42AB, ANJA43A, ANJAV1A...)	09.02 -	F1AE0481A		3400 700 514 	280 10	XTend Schaltgetriebe, automatisch betätigt / Automated Manual Transmission Nabenprofil / Hub Profile: 23x29-10N Nur zusammen verbauen / Only install together (55) (46) (51)	
				6594 000 054	280 280Z	nur als Ersatz für angegebene OE-Nr. / only for the listed OE-Numbers (100)	
		F1AE0481		3400 700 433 	235 10	Getr. / GBox: S5-200 AGJB43A2 / ANJA41A1 / ANJA42A2 / ANJA42AB Nabenprofil / Hub Profile: 23,1x29,2x10Z (46)	
35 S 11 V, 35 C 11 V	05.99 -	8140.43C		3000 951 026  3083 039 031  1878 002 072  3151 600 529	235 10 MFZ235X 235VTB KZISZ-2	Getr. / GBox: S5.200	

		CODE				
--	--	------	--	---	---	---

IVECO













DAILY III Kasten / Box		05.99 -					
35 S 15 V, 35 C 15 V (A6HCV3B2, A6HBV4B2, A6HC41B2...)	11.02-	8140.43N		3400 700 432 ■	280 10 280/Z	Getr. / GBox: S6-300 A6HA41B1 / A6HA42B1 / A6HA42B2 / A6HA43B2 / A6HA43B3 / A6HA43BB / A6HA44B2 / A6HA44B3 / A6HA44BB / A6HA44BC / A6HAV2B2 / A6HAV3B2 / A6HAV4B2 / A6HB41B1 / A6HB42B2 / A6HB43B2 / A6HB43B3 / A6HB44B2 / A6HB44B3 / A6HB44BC / A6HBV2B2 / A6HBV3B2 / A6HBV4B2 / A6HC41B2 / A6HC42B2 / A6HC43B2 / A6HC43B3 / A6HC44B2 / A6HC44B3 / A6HC44BB / A6HCV1B2 / A6HCV3B2 / A6HD42B1 / A6HD42B2 / A6HD43B2 / A6HD43B3 / A6HD43BB / A6HD44B2 / A6HD44B3 / A6HDV2B2 / A6HDV4B2 Nabenprofil / Hub Profile: 23x30,55x10Z	(46)
50 C 11 50 C 13	05.99- 05.99-	8140.43S, 8140.43C		3400 700 447 ■	265 10	Nabenprofil / Hub Profile: 23x29-10N	(46)

DAILY III Pritsche / Flatbed		05.99 -					
29 L 9 29 L 11	05.99- 05.99-	8140.63., 8140.43B, 8140.43C		3000 951 026 ● 3083 039 031 ● 1878 002 072 ● 3151 600 529	235 10 MFZ235X 235VTB KZISZ-2		
29 L 10 (ALJAV1A1, ALJA41AA, ALJA41A1, AHJA64A1...) 29 L 12 (ALKA41A1, AHKA64A1, ALLA51A1)	09.02- 09.02-	F1AE0481B, F1AE0481A		3400 700 514 ■	280 10	XTend Getr. / GBox: ZF 6S-300A Nabenprofil / Hub Profile: 23x29-10N Nur zusammen verbauen / Only install together	(46) (51)
				6594 000 054	280 280Z	Getr. / GBox: ZF 6S-300A	
				3400 700 433 ■	235 10	Getr. / GBox: ZF S5-200 Nabenprofil / Hub Profile: 23,1x29,2x10Z	(46)
29 L 14 (AHRA11C1B1, AHRA14C1B1, AHRA64C1B1)	11.05-	F1AE0481M		3400 700 514 ■	280 10	XTend Getr. / GBox: ZF 6S-400A OD Nabenprofil / Hub Profile: 23x29-10N Nur zusammen verbauen / Only install together	(46) (51)
				6594 000 054	280 280Z	->Mot. 635746 Getr. / GBox: ZF 6S-400A OD	
				3400 700 433 ■	235 10	Getr. / GBox: ZF 5S-300 Nabenprofil / Hub Profile: 23,1x29,2x10Z je nach Ausführung, mit unterschiedlicher Kupplung / depending on version, with different clutch	(46) (85)
				3400 700 483	267 10	Getr. / GBox: ZF 5S-300 Nabenprofil / Hub Profile: 23,05x30,57x10Z je nach Ausführung, mit unterschiedlicher Kupplung / depending on version, with different clutch	(46) (85)
				6594 000 054	280 280Z	Getr. / GBox: ZF 5S-300	
35 C 9, 35 S 9	11.01-04.06	8140.43R		3000 951 026 ● 3083 039 031 ● 1878 002 072 ● 3151 600 529	235 10 MFZ235X 235VTB KZISZ-2	Getr. / GBox: S5-200	
35 C 10 V, 35 S 10 V (AMJA11A1, AMJA14A1, AMJA64A1...)	09.02-	F1AE0481A		3400 700 514 ■	280 10	XTend Schaltgetriebe, automatisch betätigt / Automated Manual Transmission Nabenprofil / Hub Profile: 23x29-10N Nur zusammen verbauen / Only install together	(55) (46) (51)
				6594 000 054	280 280Z	nur als Ersatz für angegebene OE-Nr. / only for the listed OE-Numbers	(100)
		F1AE0481		3400 700 433 ■	235 10	Getr. / GBox: S5-200 AEJA14A1 / AEJB65A1 / AMJA11A1 / AMJA14A1 / AMJA64A1 / AMJA65A1 Nabenprofil / Hub Profile: 23,1x29,2x10Z	(46)
35 C 12, 35 S 12 (AEKA14A1, AEKA14AA, AEKA64A1...)	09.02-	F1AE0481B		3400 700 514 ■	280 10	XTend Schaltgetriebe, automatisch betätigt / Automated Manual Transmission Nabenprofil / Hub Profile: 23x29-10N Nur zusammen verbauen / Only install together	(55) (46) (51)
				6594 000 054	280 280Z	nur als Ersatz für angegebene OE-Nr. / only for the listed OE-Numbers	(100)
		F1AE0481		3400 700 433 ■	235 10	Getr. / GBox: S5-200 AEKA14A1 / AEKA14AA / AEKA64A1 / AEKB11A1 / AEKB14A1 / AEKB17A1 / AEKB65A1 / AEKB67A1 / AMKA14A1 / AMKA15A1 / AMKA64A1 Nabenprofil / Hub Profile: 23,1x29,2x10Z	(46)
35 C 15 50 C 15 65 C 15	11.01- 01.01- 11.01-	8140.43N		3400 700 432 ■	280 10 280/Z	Nabenprofil / Hub Profile: 23x30,55x10Z	(46)













		CODE				
--	--	------	--	---	---	---

IVECO

DAILY III Pritsche / Flatbed 05.99 -









35 C 17, 35 S 17	01.05 - 04.06	F1CE0481B		3400 700 515 	280 10	XTend Getr. / GBox: 6S-380A OD Nabenprofil / Hub Profile: 23x29-10N Nur zusammen verbauen / Only install together	(46)
				3400 700 448 	280 10 280/Z		Getr. / GBox: 6S-380 OD Nabenprofil / Hub Profile: 23x29-10N
35 S 9,35 C 9	05.99 -	8140.43		3000 951 026  3083 039 031  1878 002 072  3151 600 529	235 10 MFZ235X 235VTB KZISZ-2	Getr. / GBox: S5.200	
35 S 11,35 C 11 (A2FC13AA, A6FBU4AB, A2NB14A1, A2ND13A1...)	05.99 -	8140.43C		3000 951 026  3083 039 031  1878 002 072  3151 600 529	235 10 MFZ235X 235VTB KZISZ-2	Getr. / GBox: S5.200	
35 S 13,35 C 13 50 C 11 50 C 13	05.99 - 05.99 - 05.99 -	8140.43S, 8140.43C		3400 700 447 	265 10	Nabenprofil / Hub Profile: 23x29-10N	(46)

DAILY IV Kasten / Box 05.06 -

40C14 GV, 40C14 GV/P 40C14 V, 40C14 V/P	07.07 - 07.07 -	F1CE0441A, F1CE3481LC		3400 700 432 	280 10 280/Z	Getr. / GBox: 6S-400 OD Nabenprofil / Hub Profile: 23x30,55x10Z	(46)
				3400 700 483	267 10	Getr. / GBox: 5S-300 Nabenprofil / Hub Profile: 23,05x30,57x10Z	(46)
				6594 000 054 	280 280Z	->Mot. 635746 Getr. / GBox: 5S-300	
29L10 V	05.06 -	F1AE0481FA		3400 700 433 	235 10	Getr. / GBox: ZF 5S-300 Nabenprofil / Hub Profile: 23,1x29,2x10Z	(46)
				3400 700 483	267 10	Getr. / GBox: ZF 5S-300 GHAAV1A2 / GHAAV2A2 Nabenprofil / Hub Profile: 23,05x30,57x10Z	(46)
				6594 000 054 	280 280Z	Getr. / GBox: ZF 5S-300 GHAAV1A2 / GHAAV2A2	
				3400 700 514 	280 10	XTend Getr. / GBox: ZF 6S-400A OD Nabenprofil / Hub Profile: 23x29-10N Nur zusammen verbauen / Only install together	(46) (51)
				6594 000 054 	280 280Z	->Mot. 635746 Getr. / GBox: ZF 6S-400A OD	
29L12 V, 29L12 V/P 29L14 C, 29L14 C/P, 29L14 V, 29L14 V/P	05.06 - 05.06 -	F1AE0481GA, F1AE0481HA		3400 700 514 	280 10	XTend Getr. / GBox: ZF 6S-400A OD Nabenprofil / Hub Profile: 23x29-10N Nur zusammen verbauen / Only install together	(46) (51)
				6594 000 054 	280 280Z	->Mot. 635746 Getr. / GBox: ZF 6S-400A OD	
				3400 700 433 	235 10	Getr. / GBox: ZF 5S-300 Nabenprofil / Hub Profile: 23,1x29,2x10Z je nach Ausführung, mit unterschiedlicher Kupplung / depending on version, with different clutch	(46) (85)
				3400 700 483	267 10	Getr. / GBox: ZF 5S-300 Nabenprofil / Hub Profile: 23,05x30,57x10Z je nach Ausführung, mit unterschiedlicher Kupplung / depending on version, with different clutch	(46) (85)
				6594 000 054 	280 280Z	Getr. / GBox: ZF 5S-300	

		CODE				
--	--	------	--	---	---	---









IVECO

DAILY IV Kasten / Box		05.06 -		
35C12 V, 35C12 V/P, 35S12 V, 35S12 V/P	05.06-	F1AE0481GA	 3400 700 433 ■ 235 10	Getr. / GBox: ZF 5S-300 GCBA11A1 / GCBA14A1 / GCBA14AA / GCBA15A1 / GCBA15AA / GCBA17A1 / GCBA17AA / GCBA65A1 / GCBA65AA / GCBA67A1 / GCBA7AA / GCBB11A1 / GCBB11AA / GCBB14A1 / GCBB14AA / GCBB15A1 / GCBB15AA / GCBB17A1 / GCBB17AA / GCBB64A1 / GCBB64AA / GCBB65A1 / GCBB65AA / GCBB67A1 / GCBB67AA / GCBBR4A1 / GCBC14A1 / GCBC15A1 / GCBC15AA / GCBC64A1 / GCBD11A1 / GCBD14A1 / GCBD15A1 / GCBD17A1 / GCBD65A1 / GCBD67A1 / GJBA42A2 / GJBA42AA / GJBA43A2 / GJBA43A3 / GJBA43AB / GJBA43AC / GJBA46A2 / GJBA46A3 / GJBA46AB / GJBA46AC / GJBAV6A2 / GJBB41A1 / GJBB42A1 / GJBB42A2 / GJBB43A2 / GJBB43A3 / GJBB43AB / GJBB46A2 / GJBB46A3 / GJBB46AC / GJBBV3A2 / GJBBV6A2 / GJBC43A2 / GJBD43A2 / GJBD46A2 / GJBD46A3 Nabenprofil / Hub Profile: 23,1x29,2x10Z (46)
			 3400 700 514 ■ 280 10	XTend Getr. / GBox: ZF 6S-400A OD GCBA11CA / GCBA14C1 / GCBA14CA / GCBA15C1 / GCBA15CA / GCBA17C1 / GCBA17CA / GCBA65C1 / GCBA65CA / GCBB11C1 / GCBB11CA / GCBB14C1 / GCBB14CA / GCBB15C1 / GCBB15CA / GCBB17C1 / GCBB64C1 / GCBB65C1 / GCBB65CA / GCBD11C1 / GCBD14C1 / GCBD17C1 / GJBA41C1 / GJBA43C2 / GJBA43CB / GJBA46C3 / GJBBU3C2 / GJBBV3C2 / GJBD43C2 Nabenprofil / Hub Profile: 23x29-10N Nur zusammen verbauen / Only install together (46) (51)
			 6594 000 054 280 280Z	Getr. / GBox: ZF 6S-400A OD GCBA11CA / GCBA14C1 / GCBA14CA / GCBA15C1 / GCBA15CA / GCBA17C1 / GCBA17CA / GCBA65C1 / GCBA65CA / GCBB11C1 / GCBB11CA / GCBB14C1 / GCBB14CA / GCBB15C1 / GCBB15CA / GCBB17C1 / GCBB64C1 / GCBB65C1 / GCBB65CA / GCBD11C1 / GCBD14C1 / GCBD17C1 / GJBA41C1 / GJBA43C2 / GJBA43CB / GJBA46C3 / GJBBU3C2 / GJBBV3C2 / GJBD43C2
35C15 V, 35C15 V/P 35C17 V, 35C17 V/P, 35S17 V, 35S17 V/P 40C17 V, 40C17 V/P 50C17 V, 50C17 V/P 65C17 V, 65C17 V/P	05.06-07.07-	F1CE0481FA, F1CE0481HA	 3400 700 515 ■ 280 10	XTend Getr. / GBox: 6S-400A OD Nabenprofil / Hub Profile: 23x29-10N Nur zusammen verbauen / Only install together (46) (51)
	07.07-		3400 700 448 ■ 280 10 280/Z	Getr. / GBox: 6S-400 OD Nabenprofil / Hub Profile: 23x29-10N (46)
	07.07-			
35C18 V, 35C18 V/P, 35S18 V, 35S18 V/P	05.06-	F1CE0481	 3400 700 515 ■ 280 10	XTend Getr. / GBox: 6S-380A OD Getr. / GBox: 6S-400A OD Nabenprofil / Hub Profile: 23x29-10N Nur zusammen verbauen / Only install together (46) (51)
			 3151 600 529	KZISZ-2 Getr. / GBox: 6S-380A OD Getr. / GBox: 6S-400A OD
			 3400 700 448 ■ 280 10 280/Z	Getr. / GBox: 6S-380 OD Nabenprofil / Hub Profile: 23x29-10N (46)
35S14 C, 35S14 C/P, 35S14 V, 35S14 V/P, 35C14 V, 35C14 V/P 40C12 V, 40C14 V/P 40C10 V	05.06-	F1AE0481FA, F1AE0481GA, F1AE0481HA	 3400 700 514 ■ 280 10	XTend Schaltgetriebe, automatisch betätigt / Automated Manual Transmission Nabenprofil / Hub Profile: 23x29-10N Nur zusammen verbauen / Only install together (46) (51)
	05.06-		 6594 000 054 280 280Z	nur als Ersatz für angegebene OE-Nr. / only for the listed OE-Numbers (100)
	05.06-			





		CODE				
--	--	------	--	---	---	---



















IVECO

DAILY IV Kasten / Box 05.06 -

40C15 V, 40C15 V/P 40C18 V, 40C18 V/P 45C15 V 45C18 50C15 V, 50C15 V/P 50C18 V, 50C18 V/P 60C15 V 60C18 65C15 65C18	05.06- 05.06- 05.06- 05.06- 05.06- 05.06- 05.06- 05.06- 05.06- 05.06-	F1CE0481		3400 700 515 	280 10	XTend Getr. / GBox: 6S-380A OD Getr. / GBox: 6S-400A OD Nabenprofil / Hub Profile: 23x29-10N Nur zusammen verbauen / Only install together	(46) (51)
				3151 600 529	KZISZ-2	Getr. / GBox: 6S-380A OD Getr. / GBox: 6S-400A OD	
70C14 V, 70C14 V/P 70C17V, 70C17 V/P	07.07- 07.07-	F1CE0481HA, F1CE3481LC		3400 700 514 	280 10	XTend Getr. / GBox: ZF 6S-400A OD Nabenprofil / Hub Profile: 23x29-10N Nur zusammen verbauen / Only install together	(46) (51)
				6594 000 054	280 280Z	-> Mot. 635746 Getr. / GBox: ZF 6S-400A OD	
				3400 700 483	267 10	Getr. / GBox: ZF 6S-400 OD Nabenprofil / Hub Profile: 23,05x30,57x10Z	(46)
				6594 000 054	280 280Z	Getr. / GBox: ZF 6S-400 OD	

DAILY IV Kipper / Dumptruck 05.06 -

35C10 K	05.06-	F1AE0481FA		3400 700 433 	235 10	GCAA11A1 / GCAA11AA / GCAA14A1 / GCAA14AA / GCAA15A1 / GCAA17A1 / GCAA64A1 / GCAA65A1 / GCAA67A1 / GCAB14A1 / GCAB14AA / GCAB15A1 / GCAB17A1 / GCAB64A1 / GCAB65A1 / GCAB67A1 / GJAA42A1 / GJAA43A2 / GJAA46A2 / GJAA46A3 / GJAB42A2 / GJAB43A2 / GJAB43A3 / GJAB46A2 / GJAB46A3 Nabenprofil / Hub Profile: 23,1x29,2x10Z	(46)
				3400 700 514 	280 10	XTend -> Mot. 635746 Getr. / GBox: ZF 6S-400A OD GCAA11CA / GCAA14C1 / GCAA15C1 / GCAA64C1 / GCAB11C1 / GCAB11CA / GCAB14C1 / GCAB15C1 / GCAB64C1 Nabenprofil / Hub Profile: 23x29-10N Nur zusammen verbauen / Only install together	(46) (51)
				6594 000 054	280 280Z	-> Mot. 635746 Getr. / GBox: ZF 6S-400A OD GCAA11CA / GCAA14C1 / GCAA15C1 / GCAA64C1 / GCAB11C1 / GCAB11CA / GCAB14C1 / GCAB15C1 / GCAB64C1	

DAILY IV Kipper / Dumptruck 05.06 -						
35C12	05.06-	F1AE0481GA		3400 700 433 	235 10	Getr. / GBox: ZF 5S-300 GCBA11A1 / GCBA14A1 / GCBA14AA / GCBA15A1 / GCBA15AA / GCBA17A1 / GCBA17AA / GCBA65A1 / GCBA65AA / GCBA67A1 / GCBA7AA / GCBB11A1 / GCBB11AA / GCBB14A1 / GCBB14AA / GCBB15A1 / GCBB15AA / GCBB17A1 / GCBB17AA / GCBB64A1 / GCBB64AA / GCBB65A1 / GCBB65AA / GCBB67A1 / GCBB67AA / GCBBR4A1 / GCBC14A1 / GCBC15A1 / GCBC15AA / GCBC64A1 / GCBD11A1 / GCBD14A1 / GCBD15A1 / GCBD17A1 / GCBD65A1 / GCBD67A1 / GJBA42A2 / GJBA42AA / GJBA43A2 / GJBA43A3 / GJBA43AB / GJBA43AC / GJBA46A2 / GJBA46A3 / GJBA46AB GJBA46AC / GJBAV6A2 / GJBB41A1 / GJBB42A1 / GJBB42A2 / GJBB43A2 / GJBB43A3 / GJBB43AB / GJBB46A2 / GJBB46A3 / GJBB46AC / GJBBV3A2 / GJBBV6A2 / GJBC43A2 / GJBD43A2 / GJBD46A2 / GJBD46A3 Nabenprofil / Hub Profile: 23,1x29,2x10Z (46)
				3400 700 514 	280 10	XTend Getr. / GBox: ZF 6S-400A OD GCBA11CA / GCBA14C1 / GCBA14CA / GCBA15C1 / GCBA15CA / GCBA17C1 / GCBA17CA / GCBA65C1 / GCBA65CA / GCBB11C1 / GCBB11CA / GCBB14C1 / GCBB14CA / GCBB15C1 / GCBB15CA / GCBB17C1 / GCBB64C1 / GCBB65C1 / GCBB65CA / GCBD11C1 / GCBD14C1 / GCBD17C1 / GJBA41C1 / GJBA43C2 / GJBA43CB / GJBA46C3 / GJBBU3C2 / GJBBV3C2 / GJBD43C2 Nabenprofil / Hub Profile: 23x29-10N Nur zusammen verbauen / Only install together (46) (51)
				6594 000 054	280 280Z	Getr. / GBox: ZF 6S-400A OD GCBA11CA / GCBA14C1 / GCBA14CA / GCBA15C1 / GCBA15CA / GCBA17C1 / GCBA17CA / GCBA65C1 / GCBA65CA / GCBB11C1 / GCBB11CA / GCBB14C1 / GCBB14CA / GCBB15C1 / GCBB15CA / GCBB17C1 / GCBB64C1 / GCBB65C1 / GCBB65CA / GCBD11C1 / GCBD14C1 / GCBD17C1 / GJBA41C1 / GJBA43C2 / GJBA43CB / GJBA46C3 / GJBBU3C2 / GJBBV3C2 / GJBD43C2
35C15 35C17 K, 35C17 DK, 35S17 K, 35S17 DK 40C17 K, 40C17 DK 50C17 K, 50C17 DK 65C17 K, 65C17 DK, 65C17KK	05.06- 07.07- 07.07- 07.07-	F1CE0481FA, F1CE0481HA		3400 700 515 	280 10	XTend Getr. / GBox: 6S-400A OD Nabenprofil / Hub Profile: 23x29-10N Nur zusammen verbauen / Only install together (46) (51)
				3400 700 448 	280 10 280/Z	Getr. / GBox: 6S-400 OD Nabenprofil / Hub Profile: 23x29-10N (46)
35C18	05.06-	F1CE0481		3400 700 515 	280 10	XTend Getr. / GBox: 6S-380A OD Getr. / GBox: 6S-400A OD Nabenprofil / Hub Profile: 23x29-10N Nur zusammen verbauen / Only install together (46) (51)
				3400 700 448 	280 10 280/Z	Getr. / GBox: 6S-380 OD Nabenprofil / Hub Profile: 23x29-10N (46)
40C14 K, 40C14 DK	07.07-	F1CE3481LC		3400 700 432 	280 10 280/Z	Getr. / GBox: 6S-400 OD Nabenprofil / Hub Profile: 23x30,55x10Z (46)
				3400 700 483	267 10	Getr. / GBox: 5S-300 Nabenprofil / Hub Profile: 23,05x30,57x10Z (46)
				6594 000 054	280 280Z	->Mot. 635746 Getr. / GBox: 5S-300
50C15 50C18 60C15 60C18	05.06- 05.06- 05.06- 05.06-	F1CE0481		3400 700 515 	280 10	XTend Getr. / GBox: 6S-380A OD Getr. / GBox: 6S-400A OD Nabenprofil / Hub Profile: 23x29-10N Nur zusammen verbauen / Only install together (46) (51)
				3151 600 529	KZISZ-2	Getr. / GBox: 6S-380A OD Getr. / GBox: 6S-400A OD























		CODE				
--	--	------	--	---	---	---

IVECO

DAILY IV Kipper / Dumptruck 05.06 -

70C14 K, 70C14 DK, 70C14 KK 70C17 K, 70C17 DK, 70C17 KK	07.07 -	F1CE0481HA, F1CE3481LC		3400 700 514 	280 10	XTend Getr. / GBox: ZF 6S-400A OD Nabenprofil / Hub Profile: 23x29-10N Nur zusammen verbauen / Only install together	(46) (51)
	07.07 -			6594 000 054	280 280Z	->Mot. 635746 Getr. / GBox: ZF 6S-400A OD	
				3400 700 483	267 10	Getr. / GBox: ZF 6S-400 OD Nabenprofil / Hub Profile: 23,05x30,57x10Z	(46)
				6594 000 054	280 280Z	Getr. / GBox: ZF 6S-400 OD	

















DAILY IV Pritsche / Flatbed 05.06 -

40C14 G, 40C14 G/P 40C14, 40C14 /P	07.07 -	F1CE0441A, F1CE3481LC		3400 700 483	267 10	Getr. / GBox: 5S-300 Nabenprofil / Hub Profile: 23,05x30,57x10Z	(46)
	07.07 -			3400 700 432 	280 10 280Z	Getr. / GBox: 6S-400 OD Nabenprofil / Hub Profile: 23x30,55x10Z	(46)
				6594 000 054	280 280Z	->Mot. 635746 Getr. / GBox: 5S-300	
29L10	05.06 -	F1AE0481FA		3400 700 433 	235 10	Getr. / GBox: ZF 5S-300 Nabenprofil / Hub Profile: 23,1x29,2x10Z	(46)
				3400 700 483	267 10	Getr. / GBox: ZF 5S-300 GHAAV1A2 / GHAAV2A2 Nabenprofil / Hub Profile: 23,05x30,57x10Z	(46)
				6594 000 054	280 280Z	GHAAV1A2 / GHAAV2A2	
				3400 700 514 	280 10	XTend Getr. / GBox: ZF 6S-400A OD Nabenprofil / Hub Profile: 23x29-10N Nur zusammen verbauen / Only install together	(46) (51)
				6594 000 054	280 280Z	->Mot. 635746 Getr. / GBox: ZF 6S-400A OD	
29L12 29L14	05.06 -	F1AE0481GA, F1AE0481HA		3400 700 514 	280 10	XTend Getr. / GBox: ZF 6S-400A OD Nabenprofil / Hub Profile: 23x29-10N Nur zusammen verbauen / Only install together	(46) (51)
				6594 000 054	280 280Z	->Mot. 635746 Getr. / GBox: ZF 6S-400A OD	
				3400 700 433 	235 10	Getr. / GBox: ZF 5S-300 Nabenprofil / Hub Profile: 23,1x29,2x10Z je nach Ausführung, mit unterschiedlicher Kupplung / depending on version, with different clutch	(46) (85)
				3400 700 483	267 10	Getr. / GBox: ZF 5S-300 Nabenprofil / Hub Profile: 23,05x30,57x10Z je nach Ausführung, mit unterschiedlicher Kupplung / depending on version, with different clutch	(46) (85)
				6594 000 054	280 280Z	Getr. / GBox: ZF 5S-300	
35C10, 35S10	05.06 -	F1AE0481FA		3400 700 433 	235 10	Getr. / GBox: ZF 5S-300 GCAA11A1 / GCAA11AA / GCAA14A1 / GCAA14AA / GCAA15A1 / GCAA17A1 / GCAA64A1 / GCAA65A1 / GCAA67A1 / GCAB14A1 / GCAB14AA / GCAB15A1 / GCAB17A1 / GCAB64A1 / GCAB65A1 / GCAB67A1 / GJAA42A1 / GJAA43A2 / GJAA46A2 / GJAA46A3 / GJAB42A2 / GJAB43A2 / GJAB43A3 / GJAB46A2 / GJAB46A3 Nabenprofil / Hub Profile: 23,1x29,2x10Z	(46)
				3400 700 514 	280 10	XTend ->Mot. 635746 Getr. / GBox: ZF 6S-400A OD GCAA11CA / GCAA14C1 / GCAA15C1 / GCAA64C1 / GCAB11C1 / GCAB11CA / GCAB14C1 / GCAB15C1 / GCAB64C1 Nabenprofil / Hub Profile: 23x29-10N Nur zusammen verbauen / Only install together	(46) (51)
				6594 000 054	280 280Z	->Mot. 635746 Getr. / GBox: ZF 6S-400A OD GCAA11CA / GCAA14C1 / GCAA15C1 / GCAA64C1 / GCAB11C1 / GCAB11CA / GCAB14C1 / GCAB15C1 / GCAB64C1	

		CODE				
--	--	------	--	---	---	---







IVECO











DAILY IV Pritsche / Flatbed 05.06 -





35C12, 35S12	05.06-	F1AE0481GA		3400 700 433 	235 10	Getr. / GBox: ZF 5S-300 GCBA11A1 / GCBA14A1 / GCBA14AA / GCBA15A1 / GCBA15AA / GCBA17A1 / GCBA17AA / GCBA65A1 / GCBA65AA / GCBA67A1 / GCBA7AA / GCBB11A1 / GCBB11AA / GCBB14A1 / GCBB14AA / GCBB15A1 / GCBB15AA / GCBB17A1 / GCBB17AA / GCBB64A1 / GCBB64AA / GCBB65A1 / GCBB65AA / GCBB67A1 / GCBB67AA / GCBBR4A1 / GCBC14A1 / GCBC15A1 / GCBC15AA / GCBC64A1 / GCBD11A1 / GCBD14A1 / GCBD15A1 / GCBD17A1 / GCBD65A1 / GCBD67A1 / GJBA42A2 / GJBA42AA / GJBA43A2 / GJBA43A3 / GJBA43AB / GJBA43AC / GJBA46A2 / GJBA46A3 / GJBA46AB / GJBA46AC / GJBAV6A2 / GJBB41A1 / GJBB42A1 / GJBB42A2 / GJBB43A2 / GJBB43A3 / GJBB43AB / GJBB46A2 / GJBB46A3 / GJBB46AC / GJBBV3A2 / GJBBV6A2 / GJBC43A2 / GJBD43A2 / GJBD46A2 / GJBD46A3 Nabenprofil / Hub Profile: 23,1x29,2x10Z	(46)
				3400 700 514 	280 10	XTend Getr. / GBox: ZF 6S-400A OD GCBA11CA / GCBA14C1 / GCBA14CA / GCBA15C1 / GCBA15CA / GCBA17C1 / GCBA17CA / GCBA65C1 / GCBA65CA / GCBB11C1 / GCBB11CA / GCBB14C1 / GCBB14CA / GCBB15C1 / GCBB15CA / GCBB17C1 / GCBB64C1 / GCBB65C1 / GCBB65CA / GCBD11C1 / GCBD14C1 / GCBD17C1 / GJBA41C1 / GJBA43C2 / GJBA43CB / GJBA46C3 / GJBBU3C2 / GJBBV3C2 / GJBD43C2 Nabenprofil / Hub Profile: 23x29-10N Nur zusammen verbauen / Only install together	(46) (51)
				6594 000 054	280 280Z	Getr. / GBox: ZF 6S-400A OD GCBA11CA / GCBA14C1 / GCBA14CA / GCBA15C1 / GCBA15CA / GCBA17C1 / GCBA17CA / GCBA65C1 / GCBA65CA / GCBB11C1 / GCBB11CA / GCBB14C1 / GCBB14CA / GCBB15C1 / GCBB15CA / GCBB17C1 / GCBB64C1 / GCBB65C1 / GCBB65CA / GCBD11C1 / GCBD14C1 / GCBD17C1 / GJBA41C1 / GJBA43C2 / GJBA43CB / GJBA46C3 / GJBBU3C2 / GJBBV3C2 / GJBD43C2	(46) (51)
35C15 35C17, 35C17 /P, 35S17, 35S17 /P, 35S17 D 35S17 W, 35S17 WD 40C17, 40C17 /P 50C17, 50C17 /P 65C17, 65C17 /P	05.06- 07.07- 07.07- 07.07- 07.07-	F1CE0481FA, F1CE0481HA		3400 700 515 	280 10	XTend Getr. / GBox: 6S-400A OD Nabenprofil / Hub Profile: 23x29-10N Nur zusammen verbauen / Only install together	(46) (51)
				3400 700 448 	280 10 280/Z	Getr. / GBox: 6S-400 OD Nabenprofil / Hub Profile: 23x29-10N	(46)
35C18, 35S18	05.06-	F1CE0481		3400 700 515 	280 10	XTend Getr. / GBox: 6S-380A OD Getr. / GBox: 6S-400A OD Nabenprofil / Hub Profile: 23x29-10N Nur zusammen verbauen / Only install together	(46) (51)
				3151 600 529	KZISZ-2	Getr. / GBox: 6S-380A OD Getr. / GBox: 6S-400A OD	
		F1CE0481HA		3400 700 448 	280 10 280/Z	Getr. / GBox: 6S-380 OD Nabenprofil / Hub Profile: 23x29-10N	(46)
35C14, 35S14, 35S14 /P 40C10 40C12	05.06- 05.06- 05.06-	F1AE0481FA, F1AE0481GA, F1AE0481HA		3400 700 514 	280 10	XTend Schaltgetriebe, automatisch betätigt / Automated Manual Transmission Nabenprofil / Hub Profile: 23x29-10N Nur zusammen verbauen / Only install together	(55) (46) (51)
				6594 000 054	280 280Z	nur als Ersatz für angegebene OE-Nr. / only for the listed OE-Numbers	(100)

		CODE				
--	--	------	--	---	---	---

IVECO













DAILY IV Pritsche / Flatbed 05.06 -							
40C15 40C18 45C15 45C18, 45C18 /P, 45C18 D, 45C18 D/P 50C15 50C18 60C15, 60C15 /P, 60C15 D, 60C15 D/P 60C18 65C15, 65C15 /P, 65C15 D, 65C15 D/P 65C18	05.06- 05.06- 05.06- 05.06- 05.06- 05.06- 05.06- 05.06- 05.06- 05.06-	F1CE0481		3400 700 515 	280 10	XTend Getr. / GBox: 6S-380A OD Getr. / GBox: 6S-400A OD Nabenprofil / Hub Profile: 23x29-10N Nur zusammen verbauen / Only install together	(46) (51)
				3151 600 529		KZISZ-2 Getr. / GBox: 6S-380A OD Getr. / GBox: 6S-400A OD	
70C14, 70C14 /P 70C17, 70C17 /P	07.07- 07.07-	F1CE0481HA, F1CE3481LC		3400 700 514 	280 10	XTend Getr. / GBox: ZF 6S-400A OD Nabenprofil / Hub Profile: 23x29-10N Nur zusammen verbauen / Only install together	(46) (51)
				3400 700 483	267 10	Getr. / GBox: ZF 6S-400 OD Nabenprofil / Hub Profile: 23,05x30,57x10Z	(46)
				6594 000 054	280 280Z	Getr. / GBox: ZF 6S-400 OD	

Daily 50...							
50 NC 55 NC	01.75- 01.75-	-Deutz		1878 600 841	280 10 280CTB		
50-8		8040		1878 600 834	250 10 250CB	09.1983->	
50-9 50-10 50 F /50 F 10 55 F 9/55 F 10 55-9 55-10	01.78- -02.82 -12.78	8340		1878 600 841	280 10 280CTB		
				1850 282 652		KZA-2	
50-9 Zeta	01.87-	8040		3482 911 001	270 MF270		
				1862 811 001	270 10 270CTB		
50-10		8340		1882 806 001 ▲	280 H280	09.1983->	
				1878 600 841	280 10 280CTB	09.1983->	
				1878 600 841	280 10 280CTB	01.1978 - 12.1983	
55-8	-12.83			1878 600 834	250 10 250CB	->02.1982	
55-12 Turbo				3400 117 701 3482 998 701 1878 997 101 3151 600 529	265 10 MFZ265 265VTP KZISZ-2	Diesel / Diesel	(19)

EuroCargo 01.91 -							
EuroCargo Euro 6		Tetcor4		3400 700 607 3482 000 419 1878 079 306 3151 000 515	362 10 MF362 362WGTZ KZIS-4	für / for: 160/186 PS Getr. / GBox: 6 AS 700 TO Getr. / GBox: 6 S 700 TO Abgasnorm: Euro 6 / Exhaust Emission Norm: Euro 6	(68) (4)
				3400 700 436 3482 000 419 1878 004 100 3151 000 515	362 10 MF362 362WGTZ KZIS-4	für / for: 206 PS Getr. / GBox: 6 AS 800 TO Getr. / GBox: 6 S 800 TO Abgasnorm: Euro 6 / Exhaust Emission Norm: Euro 6	(68) (4)
				3400 700 606 3482 001 172 1878 007 250 3151 000 515	395 10 MF395 395WGTZ KZIS-4	für / for: 220/250 PS Getr. / GBox: 6 AS 800 TO Getr. / GBox: 6 S 800 TO Abgasnorm: Euro 6 / Exhaust Emission Norm: Euro 6	(68) (4)
			3400 700 606 3482 001 172 1878 007 250 3151 000 515	395 10 MF395 395WGTZ KZIS-4	für / for: 280 PS Getr. / GBox: 6 AS 1000 TO Getr. / GBox: 6 S 1000TO Abgasnorm: Euro 6 / Exhaust Emission Norm: Euro 6	(68) (4)	
			3400 700 608	395 10	für / for: 320 PS Getr. / GBox: 12 AS 1210 TO	(68)	

		CODE				
--	--	------	--	---	---	---

IVECO















EuroCargo		01.91 -					
60 E 10	01.91 - 08.96	8040	 3400 066 031 ⊗ 3482 092 031 ⊗ 1878 074 841 ⊙ 3151 600 544	280 10 MFZ280 280GTZ KZISZ-3	->Chass. 21801116 D0BAC1A1 / D0BAC1B1 / D0BAC2A1 / D0BAC2B1 / D0BAC3A1 / D0BAC3B1 / D0BAC4A1 / D0BAC4B1		
60 E 12	01.91 - 12.96	8040	 3400 066 031 ⊗ 3482 092 031 ⊗ 1878 074 841 ⊙ 3151 600 544	280 10 MFZ280 280GTZ KZISZ-3	->Chass. 21801116 D0DAC1A1 / D0DAC1AD / D0DAC1B1 / D0DAC2A1 / D0DAC2AD / D0DAC2B1 / D0DAC2BD / D0DAC3A1 / D0DAC3AD / D0DAC3B1 / D0DAC3BD / D0DAC4A1 / D0DAC4B1 / D0DAC4BD / D0DAC6AD		
60 E 14, 60 E 14 P	01.91 -	8040	 3400 066 031 ⊗ 3482 092 031 ⊗ 1878 074 841 ⊙ 3151 600 544	280 10 MFZ280 280GTZ KZISZ-3	->Chass. 21801116 D0EAC1A1 / D0EAC1AD / D0EAC1B1 / D0EAC2A1 / D0EAC2AD / D0EAC2B1 / D0EAC3A1 / D0EAC3AD / D0EAC3B1 / D0EAC3DD / D0EAC4A1 / D0EAC4B1 / D0EAC4BD / D0EAC6A1 / D0EAC6B1 / D0EBC3A1 / D0EBC3B1 / D0EBC4B1 / D0EBC6B1		
60 E 14 K	01.91 - 12.96	8040	 3400 066 031 ⊗ 3482 092 031 ⊗ 1878 074 841 ⊙ 3151 600 544	280 10 MFZ280 280GTZ KZISZ-3	->Chass. 21801116 D0EAD1A1 / D0EAD2A1		
65 E 10	01.91 - 12.96	8040	 3400 066 031 ⊗ 3482 092 031 ⊗ 1878 074 841 ⊙ 3151 600 544	280 10 MFZ280 280GTZ KZISZ-3	->Chass. 21801116 D1BAC1A1 / D1BAC1B1 / D1BAC2A1 / D1BAC2B1 / D1BAC3A1 / D1BAC3B1 / D1BAC4A1 / D1BAC4B1		
65 E 10 K	01.91 - 12.96	8040	 3400 066 031 ⊗ 3482 092 031 ⊗ 1878 074 841 ⊙ 3151 600 544	280 10 MFZ280 280GTZ KZISZ-3	->Chass. 21801116 D1BAD1A1 / D1BAD2A1		
65 E 12, 65 E 12 P	01.91 -	8040	 3400 066 031 ⊗ 3482 092 031 ⊗ 1878 074 841 ⊙ 3151 600 544	280 10 MFZ280 280GTZ KZISZ-3	->Chass. 21801116 D1DA11B1 / D1DA12B1 / D1DA12E1 / D1DA13B1 / D1DA14B1 / D1DA14E1 / D1DA16B1 / D1DAC1A1 / D1DAC1AD / D1DAC1B1 / D1DAC2A1 / D1DAC2AD / D1DAC2B1 / D1DAC2BD / D1DAC3A1 / D1DAC3AD / D1DAC3B1 / D1DAC3D1 / D1DAC4A1 / D1DAC4B1 / D1DAC4D1 / D1DAC6A1 / D1DAC6B1 / D1DAC6D1 / D1DBC3A1 / D1DD03A5 / D1DDC1A5 / D1DDC1B5 / D1DDC3A5 / D1DDC3AE / D1DDC3B5 / D1DDC4A5 / D1DDC4B5 / D1DDC4D5 / D1DHC1A1 / D1DHC2A1 / D1DHC3A1 / D1DHC3B1 / D1DHC4A1		
65 E 12 K	01.91 - 12.00	8040	 3400 066 031 ⊗ 3482 092 031 ⊗ 1878 074 841 ⊙ 3151 600 544	280 10 MFZ280 280GTZ KZISZ-3	->Chass. 21801116 D1DAD1A1 / D1DAD1AD / D1DAD2A1 / D1DAD2AD		
65 E 13 tector	09.00 -	Tector4F4AE04 81D	 3400 700 431 ■	330 10	06.2003-> Getriebenummer / Transmission Number: 2855.6 (26) Getr. / GBox: Iveco 6-Gear Nabenprofil / Hub Profile: 1 1/2"-10N (46)		
			3400 700 431 ■	330 10	11.2000-> Getriebenummer / Transmission Number: 2855.5 (26) Getr. / GBox: Iveco 5-Gear Nabenprofil / Hub Profile: 1 1/2"-10N (46)		
65 E 14, 65 E 14 P	01.91 - 12.00	8040	 3400 066 031 ⊗ 3482 092 031 ⊗ 1878 074 841 ⊙ 3151 600 544	280 10 MFZ280 280GTZ KZISZ-3	D1EHC5A1 / D1EHC5D1 / D1ELC1A1 / D1ELC4A1 / D1ELC5B1 / D1ELC5E1		
			 3400 066 031 ⊗ 3482 092 031 ⊗ 1878 074 841 ⊙ 3151 600 544	280 10 MFZ280 280GTZ KZISZ-3	->Chass. 21801116 D1EAC2AD / D1EAC2B1 / D1EAC2BD / D1EAC2D1 / D1EAC2E1 / D1EAC3A1 / D1EAC3AD / D1EAC3B1 / D1EAC3BD / D1EAC3D1 / D1EAC3E1 / D1EAC4A1 / D1EAC4B1 / D1EAC4D1 / D1EAC4E1 / D1EAC6A1 / D1EAC6B1 / D1EAC6D1 / D1EAC6E1 / D1EB13B1 / D1EB14B1 / D1EHC1A1 / D1EHC1B1 / D1EHC2A1 / D1EHC2B1 / D1EHC4B1 / D1EHC5B1 / D1EHC7E1 / D1ELC4B1 / D1EA11B1 / D1EA12B1 / D1EA13B1 / D1EA13E1 / D1EA14B1 / D1EA14E1 / D1EA16B1 / D1EA16E1 / D1EAC1A1 / D1EAC1B1 / D1EAC2A1		
65 E 14 K	01.91 - 12.00	8040	 3400 066 031 ⊗ 3482 092 031 ⊗ 1878 074 841 ⊙ 3151 600 544	280 10 MFZ280 280GTZ KZISZ-3	->Chass. 21801116 D1EAD1A1 / D1EAD2A1 / D1EAD2AD / D1EHD1A1 / D1EHD2A1		
75 E 12, 75 E 12 P	01.91 - 12.00	8040	 3400 066 031 ⊗ 3482 092 031 ⊗ 1878 074 841 ⊙ 3151 600 544	280 10 MFZ280 280GTZ KZISZ-3	->Chass. 21801116 D2DAC2A1 / D2DAC2AD / D2DAC2B1 / D2DAC2BD / D2DAC3A1 / D2DAC3AD / D2DAC3B1 / D2DAC3BD / D2DAC3DD / D2DAC3ED / D2DAC4A1 / D2DAC4AD / D2DAC4B1 / D2DAC4BD		



IVECO





EuroCargo		01.91 -					
75 E 12 K	01.97 -	8040	3400 066 031 ⊗ 3482 092 031 ⊗ 1878 074 841 ⊙ 3151 600 544	280 10 MFZ280 280GTZ KZISZ-3	-->Chass. 21801116 D2DAD2AD / D2DAD3AD		
75 E 13 tector, 75 E 13 P tector	09.00 -	F4AE0481	3400 700 431 ■	330 10	D2MAC1A1 / D2MAC1D1 / D2MAC2A1 / D2MAC2D1 / D2MAC3A1 / D2MAC3D1 / D2MAC4A1 / D2MAC4D1 / D2MAC5A1 / D2MAC5D1 / D2MAC5D2 / D2MAC6A1 / D2MAC6D1 / D2MAC7A1 / D2MAC7A2 / D2MAC7D1 / D2MAC7D2 / D2MBC2D1 / D2MBC3A1 / D2MBC3D1 / D2MBC4A1 / D2MBC4D1 / D2MBC5A1 / D2MBC5D1 / D2MBC6A1 / D2MBC6D1 Nabenprofil / Hub Profile: 1 1/2"-10N		(46)
75 E 14, 75 E 14 P	01.91 -	8040	3400 066 031 ⊗ 3482 092 031 ⊗ 1878 074 841 ⊙ 3151 600 544	280 10 MFZ280 280GTZ KZISZ-3	-->Chass. 21801116 D2EBC4BD / D2EBC4E1 / D2EBC4ED / D2EBC5A1 / D2EBC5B1 / D2EBC5E1 / D2EBC6A1 / D2EBC6AD / D2EBC6B1 / D2EBC6D1 / D2EBC6E1 / D2EHC2A1 / D2EHC2AD / D2EHC2B1 / D2EHC2BD / D2EHC3A1 / D2EHC3AD / D2EHC3B1 / D2EHC3BD / D2EHC4A1 / D2EHC4AD / D2EHC4B1 / D2EHC4BD / D2EHC4D1 / D2EHC4DD / D2EHC4E1 / D2EHC4ED / D2EHC5A1 / D2EHC5AD / D2EHC5B1 / D2EHC5BD / D2EHC5D1 / D2EHC5DD / D2EHC5E1 / D2EHC5ED / D2EHC6A1 / D2EHC6AD / D2EHC6B1 / D2EHC6BD / D2EHC6D1 / D2EHC6DD / D2EHC6E1 / D2EHC6ED / D2EHC7A1 / D2EHC7AD / D2EHC7B1 / D2EHC7BD / D2EHC7D1 / D2EHC7DD / D2EHC7E1 / D2EHC7ED / D2ELC4A1 / D2ELC4B1 / D2ELC5A1 / D2ELC5B1 / D2ELC5BD / D2ELC5E1 / D2ELC7B1 / D2ELC7E1 / D2EAC2A1 / D2EAC2AD / D2EAC2B1 / D2EAC2BD / D2EAC3A1 / D2EAC3AD / D2EAC3B1 / D2EAC3BD / D2EAC3D1 / D2EAC3DD / D2EAC3E1 / D2EAC3ED / D2EAC4A1 / D2EAC4AD / D2EAC4B1 / D2EAC4BD / D2EAC4D1 / D2EAC4DD / D2EAC4E1 / D2EAC4ED / D2EAC5A1 / D2EAC5AD / D2EAC5B1 / D2EAC5BD / D2EAC5D1 / D2EAC5DD / D2EAC5E1 / D2EAC5ED / D2EAC6A1 / D2EAC6AD / D2EAC6B1 / D2EAC6BD / D2EAC6D1 / D2EAC6DD / D2EAC6E1 / D2EAC6ED / D2EAC7A1 / D2EAC7AD / D2EAC7B1 / D2EAC7BD / D2EBC3A1 / D2EBC3AD / D2EBC3B1 / D2EBC3D1 / D2EBC3E1 / D2EBC3ED / D2EBC4A1 / D2EBC4B1		

IVECO

EuroCargo		01.91 -							
75 E 14 tector, 75 E 14 P tector	09.06-	F4AE3481C, F4AE3481A, F4AE3681B, F4AE3481B, F4AE3481D		3400 700 487	362 10	Getr. / GBox: ZF 6AS 700 T0			
75 E 14 K tector	09.06-				3482 000 419		MF362		
75 E 16 tector, 75 E 16 P tector	09.06-				1878 079 331		362WGTZ		
75 E 16 K tector	09.06-				3151 000 515		KZIS-4		
100 E 18 tector, 100 E 18 P tector, 100 E 18 FP tector	09.06-				3400 700 474 ■		362 10	Getr. / GBox: ZF S5-42	
100 E 22 K tector	09.06-							Nabenprofil / Hub Profile: 31,01x38,53-10Z	(46)
100 E 22 W tector, 100 E 22 WS tector	09.06-							Getr. / GBox: ZF 6S 700 T0	
120 E 18 K tector	09.06-							Nabenprofil / Hub Profile: 31,02x38,55-10Z	(46)
120 E 22 D tector, 120 E 22 P tector, 120 E 22 FP tector	09.06-								
120 E 22 K tector	09.06-								
140 E 18 tector, 140 E 18 P tector, 140 E 18 D FP tector	09.06-								
140 E 18 K tector, 140 E 18 DK tector	09.06-								
140 E 22 tector, 140 E 22 P tector, 140 E 22 D FP tector	09.06-								
140 E 22 K tector	09.06-								
150 E 22 tector, 150 E 22 P tector, 150 E 22 FP tector	09.06-								
150 E 22 K tector	09.06-								
160 E 18 tector, 160 E 18 P tector	09.06-								
160 E 18 K tector	09.06-								
160 E 22 tector, 160 E 22 P tector	09.06-								
160 E 22 K tector	09.06-								
75 E 14 K	01.97-	8040		3400 066 031	280 10	->Chass. 21801116			
					3482 092 031	MFZ280	D2EAD2AD / D2EAD3AD		
					1878 074 841	280GTZ			
					3151 600 544	KZISZ-3			
75 E 15, 75 E 15 P, 80 E 15	01.91 - 09.00	8060		3400 700 449 ■	310 10	Nabenprofil / Hub Profile: 1 1/2"-10N	(46)		
75 E 15 K	01.91 - 09.00				3482 094 031	MFZ310			
					1878 000 611	310TB			
					3151 600 544	KZISZ-3			
75 E 15 tector, 75 E 15 P tector	09.00-	F4AE0481		3400 700 431 ■	330 10	D2NAC1A1 / D2NAC2AA / D2NAC2D1 / D2NAC2DA / D2NAC3A1 / D2NAC3D1 / D2NAC4A1 / D2NAC4AA / D2NAC4D1 / D2NAC4D2 / D2NAC4DA / D2NAC4DB / D2NAC5A1 / D2NAC5AA / D2NAC5D1 / D2NAC5DA / D2NAC6A1 / D2NAC6D1 / D2NAC6D2 / D2NAC7A2 / D2NAC7AB / D2NAC7D1 / D2NAC7D2 / D2NBC2A1 / D2NBC2D1 / D2NBC3A1 / D2NBC3D1 / D2NBC4A1 / D2NBC4D1 / D2NBC4D2 / D2NBC5A1 / D2NBC5A2 / D2NBC5D1 / D2NBC5D2 / D2NBC6A1 / D2NBC6D1 / D2NBC6D2 / D2NBC7A1 / D2NBC7A2 / D2NBC7D1 / D2NBC7D2	Nabenprofil / Hub Profile: 1 1/2"-10N	(46)	
75 E 15 K tector	09.00-	F4AE0481		3400 700 431 ■	330 10	D2NAC1A1 / D2NAC2A1 / D2NAC2AA / D2NAC2D1 / D2NAC2DA / D2NAC3A1 / D2NAC3D1 / D2NAC4A1 / D2NAC4A2 / D2NAC4AA / D2NAC4D1 / D2NAC4D2 / D2NAC4DA / D2NAC4DB / D2NAC5A1 / D2NAC5A2 / D2NAC5AA / D2NAC5D1 / D2NAC5D2 / D2NAC5DA / D2NAC6A1 / D2NAC6D1 / D2NAC6D2 / D2NAC7A1 / D2NAC7A2 / D2NAC7AB / D2NAC7D1 / D2NAC7D2 / D2NBC2A1 / D2NBC2D1 / D2NBC3A1 / D2NBC3D1 / D2NBC4A1 / D2NBC4D1 / D2NBC4D2 / D2NBC5A1 / D2NBC5A2 / D2NBC5D1 / D2NBC5D2 / D2NBC6A1 / D2NBC6D1 / D2NBC6D2 / D2NBC7A1 / D2NBC7A2 / D2NBC7D1 / D2NBC7D2	Nabenprofil / Hub Profile: 1 1/2"-10N	(46)	





		CODE				
--	--	------	--	---	---	---

IVECO

EuroCargo		01.91 -		
75 E 17, 75 E 17 P, 75 E 18 tector	09.00-	F4AE0481	 3400 700 431 ■ 330 10	D2PAC1A1 / D2PAC1D1 / D2PAC2A1 / D2PAC2AA / D2PAC2D1 / D2PAC2DA / D2PAC3A1 / D2PAC3AA / D2PAC3D1 / D2PAC3DA / D2PAC4A1 / D2PAC4AA / D2PAC4AB / D2PAC4D2 / D2PAC4DA / D2PAC5A1 / D2PAC5A2 / D2PAC5D1 / D2PAC5D2 / D2PAC5DA / D2PAC5DB / D2PAC6A2 / D2PAC6AA / D2PAC6AB / D2PAC6D1 / D2PAC6D2 / D2PAC6DA / D2PAC7A1 / D2PAC7A2 / D2PAC7AA / D2PAC7AB / D2PAC7D1 / D2PAC7D2 / D2PAC7DA / D2PAC7DB / D2PBC2A1 / D2PBC2D1 / D2PBC3A1 / D2PBC3AA / D2PBC3D1 / D2PBC4A1 / D2PBC4A2 / D2PBC4AA / D2PBC4D1 / D2PBC4D2 / D2PBC4DA / D2PBC5A1 / D2PBC5AA / D2PBC5D1 / D2PBC5D2 / D2PBC5DA / D2PBC6A1 / D2PBC6AA / D2PBC6AB / D2PBC6D1 / D2PBC6D2 / D2PBC6DA / D2PBC7A1 / D2PBC7A2 / D2PBC7AA / D2PBC7AB / D2PBC7D1 / D2PBC7D2 / D2PBC7DB Nabenprofil / Hub Profile: 1 1/2"-10N (46)
		F4AE3481B, F4AE0481A	 3400 700 452 ■ 350 10	D2RAC6D1 / D2RAC6D2 / DJRAC7AB / DJRAC7D1 / D2RAC6DA / DJRAC7D2 / D2RAC6DB / D2RAC7A1 / DJRAC7DA / DJRAC7DB / D2RAC7AA / DJRBC2A1 / D2RAC7AB / DJRBC2D1 / D2RAC7D1 / DJRBC3D1 / D2RAC7D2 / DJRBC4A1 / D2RAC7DA / DJRBC4D1 / D2RAC7DB / D2RBC2A1 / DJRBC4D2 / D2RBC2D1 / DJRBC5A1 / DJRBC5D1 / D2RBC3D1 / DJRBC5D2 / D2RBC4A1 / DJRBC6A1 / D2RBC4D1 / D2RBC5A1 / DJRBC6AA / DJRBC6AB / D2RBC5A2 / D2RBC5AA / DJRBC6D1 / DJRBC6D2 / D2RBC5AB / D2RBC5D1 / DJRBC6DA / DJRBC7A1 / D2RBC5D2 / DJRBC7A2 / D2RBC6A2 / D2RAC2A1 / DJRAC1A1 / D2RAC2AA / DJRAC1D1 / DJRAC2A1 / D2RAC2D1 / D2RAC2DA / DJRAC2AA / D2RAC3AA / DJRAC2D1 / DJRAC2DA / D2RAC3D1 / D2RAC4A1 / DJRAC3AA / DJRAC3D1 / D2RAC4AA / D2RAC4D1 / DJRAC3DA / DJRAC4A1 / D2RAC4D2 / D2RAC4DA / DJRAC4AA / DJRAC4D1 / D2RAC5A1 / DJRAC5A1 / D2RAC5A2 / DJRAC5AA / D2RAC5AA / D2RAC5AB / DJRAC5D1 / DJRAC5DA / D2RAC5D1 / DJRAC6A1 / D2RAC5D2 / DJRAC6AA / D2RAC5DA / DJRAC6AB / D2RAC6A1 / DJRAC6D1 / D2RAC6A2 / D2RAC6AA / DJRAC6D2 / D2RAC6AB / DJRAC6DA / DJRAC7AA / DJRBC7AA / D2RBC6AA / D2RBC6D1 / DJRBC7AB / DJRBC7D1 / D2RBC6D2 / D2RBC6DA / DJRBC7D2 / D2RBC7AA / DJRBC7DA / DJRBC7DB / D2RBC7AB / D2RBC7D1 / D2RBC7D2 / D2RBC7DB Nabenprofil / Hub Profile: 1 1/2"-10N (46)
75 E 17 K, 75 E 18 K tector	09.00-	F4AE0481	 3400 700 431 ■ 330 10	D2PAC1A1 / D2PAC1D1 / D2PAC2A1 / D2PAC2AA / D2PAC2D1 / D2PAC2DA / D2PAC3A1 / D2PAC3AA / D2PAC3D1 / D2PAC3DA / D2PAC4A1 / D2PAC4AA / D2PAC4AB / D2PAC4D1 / D2PAC4D2 / D2PAC4DA / D2PAC5A1 / D2PAC5A2 / D2PAC5AA / D2PAC5D1 / D2PAC5DB / D2PAC6A2 / D2PAC6AA / D2PAC6AB / D2PAC6D1 / D2PAC6D2 / D2PAC6DA / D2PAC7A1 / D2PAC7A2 / D2PAC7AA / D2PAC7AB / D2PAC7D1 / D2PAC7D2 / D2PAC7DA / D2PAC7DB / D2PBC2A1 / D2PBC2D1 / D2PBC3A1 / D2PBC3AA / D2PBC3D1 / D2PBC4A1 / D2PBC4A2 / D2PBC4AA / D2PBC4D1 / D2PBC4D2 / D2PBC4DA / D2PBC5A1 / D2PBC5AA / D2PBC5D1 / D2PBC5D2 / D2PBC5DA / D2PBC6A1 / D2PBC6AA / D2PBC6AB / D2PBC6D1 / D2PBC6D2 / D2PBC6DA / D2PBC7A1 / D2PBC7A2 / D2PBC7AA / D2PBC7AB / D2PBC7D1 / D2PBC7D2 / D2PBC7DB Nabenprofil / Hub Profile: 1 1/2"-10N (46)
		F4AE3481B, F4AE0481A	 3400 700 452 ■ 350 10	D2RAC2A1 / DJRAC1A1 / D2RAC2AA / DJRAC1D1 / DJRAC2A1 / D2RAC2D1 / DJRAC2AA / D2RAC2DA / DJRAC2D1 / D2RAC3AA / D2RAC3D1 / DJRAC2DA / DJRAC3AA / D2RAC4A1 / DJRAC3D1 / D2RAC4AA / DJRAC3DA / D2RAC4D1 / DJRAC4A1 / D2RAC4D2 / D2RAC4DA / DJRAC4AA / D2RAC5A1 / DJRAC4D1 / DJRAC5A1 / D2RAC5A2 / D2RAC5AA / DJRAC5AA / DJRAC5D1 / D2RAC5AB / D2RAC5DA / DJRAC5DA

		CODE				
--	--	------	--	---	---	---

IVECO

EuroCargo		01.91 -						
75 E 18 tector, 75 E 18 P tector 75 E 18 K tector	09.00 - 09.00 -	F4AE0681D, F4AE0681E		3400 700 452 ■	350 10	DJRAC1A1 / D2RAC2A1 / DJRAC1D1 / D2RAC2AA / DJRAC2A1 / D2RAC2D1 / D2RAC2DA / DJRAC2AA / DJRAC2D1 / D2RAC3AA / D2RAC3D1 / DJRAC2DA / DJRAC3AA / D2RAC4A1 / D2RAC4AA / DJRAC3D1 / DJRAC3DA / D2RAC4D1 / DJRAC4A1 / D2RAC4D2 / D2RAC4DA / DJRAC4AA / D2RAC5A1 / DJRAC4D1 / D2RAC5A2 / DJRAC5A1 / DJRAC5AA / D2RAC5AA / DJRAC5D1 / D2RAC5AB / D2RAC5D1 / DJRAC5DA / DJRAC6A1 / D2RAC5D2 / DJRAC6AA / D2RAC5DA / DJRAC6AB / D2RAC6A1 / D2RAC6A2 / DJRAC6D1 / DJRAC6D2 / D2RAC6AA / D2RAC6AB / DJRAC6DA / DJRAC7AA / D2RAC6D1 / DJRAC7AB / D2RAC6D2 / D2RAC6DA / DJRAC7D1 / DJRAC7D2 / D2RAC6DB / D2RAC7A1 / DJRAC7DA / D2RAC7AA / DJRAC7DB / DJRBC2A1 / D2RAC7AB / DJRBC2D1 / D2RAC7D1 / DJRBC3D1 / D2RAC7D2 / D2RAC7DA / DJRBC4A1 / DJRBC4D1 / D2RAC7DB / D2RBC2A1 / DJRBC4D2 / DJRBC5A1 / D2RBC2D1 / DJRBC5D1 / D2RBC3D1 / D2RBC4A1 / DJRBC5D2 / DJRBC6A1 / D2RBC4D1 / DJRBC6AA / D2RBC5A1 / D2RBC5A2 / DJRBC6AB / D2RBC5AA / DJRBC6D1 / D2RBC5AB / DJRBC6D2 / DJRBC6DA / D2RBC5D1 / D2RBC5D2 / DJRBC7A1 / DJRBC7A2 / D2RBC6A2 / D2RBC6AA / DJRBC7AA / D2RBC6D1 / DJRBC7AB / DJRBC7D1 / D2RBC6D2 / D2RBC6DA / DJRBC7D2 / DJRBC7DA / D2RBC7AA / DJRBC7DB / D2RBC7AB / D2RBC7D1 / D2RBC7D2 / D2RBC7DB		
						Nabenprofil / Hub Profile: 1 1/2"-10N	(46)	
80 E 15, 80 E 15 P	01.91 -	8060		3400 700 449 ■ ⊗ 3482 094 031 ⊗ 1878 000 611 ⊙ 3151 600 544	310 10 MFZ310 310TB KZISZ-3	Getriebenummer / Transmission Number: 2845.6 D3HA12B1 / D3HA13B1 / D3HA13BD / D3HA13E1 / D3HA13ED / D3HA14B1 / D3HA14BD / D3HA14E1 / D3HA14ED / D3HA15B1 / D3HA15E1 / D3HA15ED / D3HA16B1 / D3HA16E1 / D3HA31B1 / D3HA32B1 / D3HA32BD / D3HA33B1 / D3HA33BD / D3HAC2B1 / D3HAC3B1 / D3HAC3BD / D3HAC3E1 / D3HAC4B1 / D3HAC4BD / D3HAC4E1 / D3HAC5B1 / D3HAC5BD / D3HAC5E1 / D3HAC5ED / D3HAC6B1 / D3HAC6BD / D3HAC6E1 / D3HAC6ED / D3HAC7B1 / D3HAC7BD / D3HB13B1 / D3HB13E1 / D3HB14B1 / D3HB14BD / D3HB14E1 / D3HB15B1 / D3HB15E1 / D3HB16B1 / D3HB16E1 D3HBC3B1 / D3HBC3BD / D3HBC3E1 / D3HBC3ED / D3HBC4B1 / D3HBC4E1 / D3HBC5B1 / D3HBC5BD / D3HBC5E1 / D3HBC6B1 / D3HBC6E1 / D3HDC3B5 / D3HDC3BE / D3HDC4EE / D3HHC1B1 / D3HHC2B1 / D3HHC3B1 / D3HHC4B1 / D3HHC4E1 / D3HHC5B1 / D3HHC5BD / D3HHC5E1 / D3HHC6B1 / D3HHC6E1 / D3HHC7B1 / D3HHC7BD / D3HHC7E1 / D3HLC4B1 / D3HLC4E1 / D3HLC5B1 / D3HLC6B1		
						Nabenprofil / Hub Profile: 1 1/2"-10N	(46)	
				3400 700 449 ■ ⊗ 3482 094 031 ⊗ 1878 000 611 ⊙ 3151 600 544	310 10 MFZ310 310TB KZISZ-3	Getriebenummer / Transmission Number: 2845.5 D3HAC2A1 / D3HAC2AD / D3HAC3A1 / D3HAC3AD / D3HAC3D1 / D3HAC4A1 / D3HAC4AD / D3HAC4D1 / D3HAC5A1 / D3HAC5AD / D3HAC5D1 / D3HAC6A1 / D3HAC6AD / D3HAC6D1 / D3HAC6DD / D3HAC7A1 / D3HBC3A1 / D3HBC3AD / D3HBC4A1 / D3HBC4DD / D3HBC5A1 / D3HBC6A1 / D3HDC2AE / D3HDC3A5 / D3HDC4A5 / D3HDC5A5 / D3HHC1A1 / D3HHC2A1 / D3HHC2AD / D3HHC3A1 / D3HHC4A1 / D3HHC4AD / D3HHC5A1 / D3HHC6A1 / D3HHC7A1 / D3HHC7AD / D3HLC4A1		
						Nabenprofil / Hub Profile: 1 1/2"-10N	(46)	
80 E 15 K 80 E 15 K	01.91 - 01.91 -	8060		3400 700 449 ■ ⊗ 3482 094 031 ⊗ 1878 000 611 ⊙ 3151 600 544	310 10 MFZ310 310TB KZISZ-3	Getriebenummer / Transmission Number: 2845.6 D3HAD1B1 / D3HAD2B1 / D3HAD2BD / D3HAD3B1 / D3HAD3BD		
						Nabenprofil / Hub Profile: 1 1/2"-10N	(46)	
				3400 700 449 ■ ⊗ 3482 094 031 ⊗ 1878 000 611 ⊙ 3151 600 544	310 10 MFZ310 310TB KZISZ-3	Getriebenummer / Transmission Number: 2845.5 D3HAD1A1 / D3HAD2A1 / D3HAD2AD / D3HAD3A1 / D3HAD3AD		
						Nabenprofil / Hub Profile: 1 1/2"-10N	(46)	
80 EL 15 tector	09.00 -	Tector4F4AE04 81C		3400 700 431 ■	330 10	06.2003-> Getriebenummer / Transmission Number: 2855.5/6 Getr. / GBox: Iveco 5/6-Gear		
						Nabenprofil / Hub Profile: 1 1/2"-10N	(46)	







		CODE				
--	--	------	--	--	--	--

IVECO

EuroCargo		01.91 -				
80 E 17, 80 E 17 D tector, 80 E 17 DP tector, 80 E 18 tector 80 E 17 K, 80 E 17 DK tector, 80 E 18 K tector	09.00-	Tector4F4AE04 81A		3400 700 431 ■	330 10	06.2003-> Getriebeummer / Transmission Number: 2855.5 Getr. / GBox: Iveco 5-Gear Nabenprofil / Hub Profile: 1 1/2"-10N (26)
	09.00-			3400 700 430 ■	350 10	06.2003-> Getriebeummer / Transmission Number: 2870.9 Getr. / GBox: Iveco 9-Gear Nabenprofil / Hub Profile: 1 1/2"-10N (46)
				3400 700 431 ■	330 10	11.2000-> Getriebeummer / Transmission Number: 2855.6 Getr. / GBox: Iveco 6-Gear Nabenprofil / Hub Profile: 1 1/2"-10N (46)
80 E 18, 80 E 18 P, 18 E 80 FP	01.91 -	8060		3400 700 449 ■ ☉ 3482 094 031 ☉ 1878 000 611 ◆ 3151 600 544	310 10 MFZ310 310TB KZISZ-3	Getriebeummer / Transmission Number: 2855.6 D3KHC1A1 / D3KHC2A1 / D3KHC2AD / D3KHC3A1 / D3KHC3AD / D3KHC4A1 / D3KHC4AD / D3KHC4D1 / D3KHC4DD / D3KHC5A1 / D3KHC5AD / D3KHC5D1 / D3KHC5DD / D3KHC6A1 / D3KHC6AD / D3KHC6D1 / D3KHC6DD / D3KHC7A1 / D3KHC7AD / D3KHC7D1 / D3KHC7DD / D3KLC4A1 / D3KLC5A1 / D3KLC6A1 / D3KLC6D1 / D3KLC7A1 / D3KLC7D1 / D3KA12A1 / D3KA12AD / D3KA13A1 / D3KA13C1 / D3KA14A1 / D3KA14C1 / D3KA15A1 / D3KA15C1 / D3KA15CD / D3KA16A1 / D3KA16C1 / D3KAC2A1 / D3KAC2AD / D3KAC3A1 / D3KAC3AD / D3KAC3C1 / D3KAC3CD / D3KAC4A1 D3KAC4AD / D3KAC4C1 / D3KAC4CD / D3KAC5A1 / D3KAC5AD / D3KAC5C1 / D3KAC5CD / D3KAC6A1 / D3KAC6AD / D3KAC6C1 / D3KAC6CD / D3KAC7A1 / D3KB13A1 / D3KB13C1 / D3KB14A1 / D3KB14AD / D3KB14C1 / D3KB15A1 / D3KB15C1 / D3KB15CD / D3KB16A1 / D3KB16AD / D3KB16C1 / D3KBC3A1 / D3KBC3AD / D3KBC4A1 / D3KBC4AD / D3KBC4CD / D3KBC5A1 / D3KBC5CD / D3KBC6A1 / D3KBC6AD / D3KBC6C1 / D3KBC6CD / D3KAC7A1 / D3KB13A1 / D3KB13C1 / D3KB14A1 / D3KB14AD / D3KB14C1 / D3KB15A1 / D3KB15C1 / D3KB15CD / D3KB16A1 / D3KB16AD / D3KB16C1 / D3KBC3A1 / D3KBC3AD / D3KBC4A1 / D3KBC4AD D3KBC4CD / D3KBC5A1 / D3KBC5CD / D3KBC6A1 / D3KCC4A1 / D3KCC4C1 / D3KCC5A1 / D3KCC5C1 / D3KCC6A1 / D3KCC6C1 / D3KDC4A5 / D3KDC5A5 / D3KHC1A1 / D3KHC2A1 / D3KHC2AD / D3KHC3A1 / D3KHC3AD / D3KHC4A1 / D3KHC4AD / D3KHC4D1 / D3KHC4DD / D3KHC5A1 / D3KHC5AD / D3KHC5D1 / D3KHC5DD / D3KHC6A1 / D3KHC6AD / D3KHC6D1 / D3KHC6DD / D3KHC7A1 / D3KHC7AD / D3KHC7D1 / D3KHC7DD / D3KLC4A1 / D3KLC5A1 / D3KLC6A1 / D3KLC6D1 / D3KLC7A1 / D3KLC7D1 Nabenprofil / Hub Profile: 1 1/2"-10N (46)
80 E 18, 80 E 18 P, 18 E 80 FP	01.91 -	8060		3400 700 449 ■ ☉ 3482 094 031 ☉ 1878 000 611 ◆ 3151 600 544	310 10 MFZ310 310TB KZISZ-3	Getriebeummer / Transmission Number: 2855.6 D3KA12A1 / D3KA12AD / D3KA13A1 / D3KA13C1 / D3KA14A1 / D3KA14C1 / D3KA15A1 / D3KA15C1 / D3KA15CD / D3KA16A1 / D3KA16C1 / D3KAC2A1 / D3KAC2AD / D3KAC3A1 / D3KAC3AD / D3KAC3C1 / D3KAC3CD / D3KAC4A1 / D3KAC4AD / D3KAC4C1 / D3KAC4CD / D3KAC5A1 / D3KAC5AD / D3KAC5C1 / D3KAC5CD / D3KAC6A1 / D3KAC6AD / D3KAC6C1 / D3KAC6CD / D3KAC7A1 / D3KB13A1 / D3KB13C1 / D3KB14A1 / D3KB14AD / D3KB14C1 / D3KB15A1 / D3KB15C1 / D3KB15CD / D3KB16A1 / D3KB16AD / D3KB16C1 / D3KBC3A1 / D3KBC3AD / D3KBC4A1 / D3KBC4AD D3KBC4CD / D3KBC5A1 / D3KBC5CD / D3KBC6A1 / D3KCC4A1 / D3KCC4C1 / D3KCC5A1 / D3KCC5C1 / D3KCC6A1 / D3KCC6C1 / D3KDC4A5 / D3KDC5A5 / D3KHC1A1 / D3KHC2A1 / D3KHC2AD / D3KHC3A1 / D3KHC3AD / D3KHC4A1 / D3KHC4AD / D3KHC4D1 / D3KHC4DD / D3KHC5A1 / D3KHC5AD / D3KHC5D1 / D3KHC5DD / D3KHC6A1 / D3KHC6AD / D3KHC6D1 / D3KHC6DD / D3KHC7A1 / D3KHC7AD / D3KHC7D1 / D3KHC7DD / D3KLC4A1 / D3KLC5A1 / D3KLC6A1 / D3KLC6D1 / D3KLC7A1 / D3KLC7D1 Nabenprofil / Hub Profile: 1 1/2"-10N (46)
80 E 18 tector, 80 E 18 D tector, 80 E 18 DP tector 80 E 18 K tector, 80 E 18 DK tector 90 E 18 tector, 90 E 18 D tector, 90 E 18 DP tector 90 E 18 K tector, 90 E 18 DK tector	09.00- 09.00- 09.00- 09.00-	Tector6F4AE06 81E		3400 700 430 ■	350 10	11.2000-> Getriebeummer / Transmission Number: 2870.9 Getr. / GBox: Iveco 9-Gear Nabenprofil / Hub Profile: 1 1/2"-10N (26) (46)
80 E 18 K 80 E 18 K	01.91 - 01.91 -	8060		3400 700 449 ■ ☉ 3482 094 031 ☉ 1878 000 611 ◆ 3151 600 544	310 10 MFZ310 310TB KZISZ-3	Getriebeummer / Transmission Number: 2855.6 D3KA33A1 / D3KA33AD / D3KAD1A1 / D3KAD2A1 / D3KAD2AD / D3KAD3A1 / D3KAD3AD / D3KAD1A1 / D3KAD2A1 / D3KAD4A1 / D3KA31A1 / D3KA32A1 / D3KA32AD Nabenprofil / Hub Profile: 1 1/2"-10N (46)



		CODE				
--	--	------	--	---	---	---

IVECO

EuroCargo		01.91 -					
80 E 21, 80 E 21 P, 80 E 21 FP 80 E 21, 80 E 21 P, 21 E 80 FP	01.91 - 01.91 -	8060	 3400 068 031 ⊗ 3482 093 031 ⊗ 1862 310 132 ⊙ 3151 600 544	330 10 MFZ330 330GSB KZISZ-3	Getriebeummer / Transmission Number: 2865.6 D3LA12A1 / D3LA13A1 / D3LA13C1 / D3LA14A1 / D3LA14C1 / D3LA15A1 / D3LA15C1 / D3LA16A1 / D3LA16C1 / D3LAC2A1 / D3LAC3A1 / D3LAC3C1 / D3LAC4A1 / D3LAC4C1 / D3LAC5A1 / D3LAC5C1 / D3LAC6A1 / D3LAC6C1 / D3LB13A1 / D3LB13C1 / D3LB14A1 / D3LB14C1 / D3LB15A1 / D3LB15C1 / D3LB16A1 / D3LB16C1 / D3LBC3A1 / D3LBC4A1 / D3LBC5A1 / D3LCC4C1 / D3LHC4A1 / D3LHC4D1 / D3LHC5A1 / D3LHC7D1 / D3LLC5A1 / D3LLC5D1 / D3LLC6D1 / D3LLC7A1 / D3LLC7D1 / D3LMC7D1	(26)	
80 E 21, 80 E 21 D tector, 80 E 21 DP tector, 80 E 22 tector 80 E 21 K, 80 E 21 DK tector, 80 E 22 K tector	09.00 - 09.00 -	Tector6F4AE06 81D	 3400 700 430 ■	350 10	06.2003-> Getriebeummer / Transmission Number: 2870.9 Getr. / GBox: Iveco 9-Gear Nabenprofil / Hub Profile: 1 1/2"-10N	(26) (46)	
90 E 21, 90 E 21 D tector, 90 E 21 DP tector, 90 E 22 tector 90 E 21 K tector, 90 E 21 DK tector	09.00 - 09.00 -		3400 700 430 ■	350 10	06.2003-> Getriebeummer / Transmission Number: 2865.6 Getr. / GBox: Iveco 6-Gear Nabenprofil / Hub Profile: 1 1/2"-10N	(26) (46)	
90 E 17, 90 E 17D tector, 90 E 17 DP tector, 90 E 18 tector 90 E 17 K tector, 90 E 17 DK tector	09.00 - 09.00 -	Tector4F4AE04 81A	 3400 700 430 ■	350 10	06.2003-> Getriebeummer / Transmission Number: 2870.9 Getr. / GBox: Iveco 9-Gear Nabenprofil / Hub Profile: 1 1/2"-10N	(26) (46)	
			3400 700 431 ■	330 10	11.2000-> Getriebeummer / Transmission Number: 2855.6 Getr. / GBox: Iveco 6-Gear Nabenprofil / Hub Profile: 1 1/2"-10N	(26) (46)	
95 E 15 W	11.93 -	8060	 3400 700 449 ■ ⊗ 3482 094 031 ⊗ 1878 000 611 ⊙ 3151 600 544	310 10 MFZ310 310TB KZISZ-3	Getriebeummer / Transmission Number: 2845.6 D4HE11B1 / D4HE12B1 / D4HE12BD / D4HPC1B1 / D4HPC1BD / D4HPC2B1 Nabenprofil / Hub Profile: 1 1/2"-10N	(26) (46)	
			3400 700 449 ■	310 10	Getriebeummer / Transmission Number: 2845.5 D4HE11A1 / D4HE12A1 / D4HE12AD / D4HPC1A1 / D4HPC2A1 Nabenprofil / Hub Profile: 1 1/2"-10N	(26) (46)	
95 E 21 W	11.93 -	8060	 3400 068 031 ⊗ 3482 093 031 ⊗ 1862 310 132 ⊙ 3151 600 544	330 10 MFZ330 330GSB KZISZ-3	->Chass. 2253628 Getr. / GBox: 2865.6 D4LE11A1 / D4LE11AD / D4LE12A1 / D4LE12AD / D4LPC1A1 / D4LPC1AD / D4LPC2A1 / D4LPC2AD		
			3400 068 031	330 10	->Chass. 2253628 Getr. / GBox: S6-36/2-5 D4LPC1C1		
			3400 068 031	330 10	->Chass. 2253628 Getr. / GBox: S6-36 D4LPC2C1		
100 E 15, 100 E 15 P	01.91 -	8060	 3400 700 449 ■ ⊗ 3482 094 031 ⊗ 1878 000 611 ⊙ 3151 600 544	310 10 MFZ310 310TB KZISZ-3	Getriebeummer / Transmission Number: 2845.6 D4HA12B1 / D4HA12BD / D4HA13B1 / D4HA13BD / D4HA14B1 / D4HA14BD / D4HA15B1 / D4HA15E1 / D4HA16B1 / D4HA16E1 / D4HAC2B1 / D4HAC2BD / D4HAC3B1 / D4HAC3BD / D4HAC4B1 / D4HAC4BD / D4HAC4E1 / D4HAC4ED / D4HAC5B1 / D4HAC5BD / D4HAC5E1 / D4HAC5ED / D4HAC6B1 / D4HAC6BD / D4HAC6E1 / D4HAC6ED / D4HHC1B1 / D4HHC2B1 / D4HHC2BD / D4HHC3B1 / D4HHC4B1 / D4HHC4BD / D4HHC5B1 / D4HHC5BD / D4HHC5E1 / D4HHC6B1 / D4HHC6BD / D4HHC6E1 / D4HHC6ED / D4HHC7B1 / D4HHC7BD / D4HHC7E1 / D4HHC7ED / D4HLC5B1 / D4HLC5BD D4HLC6B1 / D4HLC7B1 Nabenprofil / Hub Profile: 1 1/2"-10N	(26) (46)	
			3400 700 449 ■	310 10	Getriebeummer / Transmission Number: 2845.5 D4HAC2A1 / D4HAC2AD / D4HAC3A1 / D4HAC3AD / D4HAC4A1 / D4HAC4AD / D4HAC4D1 / D4HAC4DD / D4HAC5A1 / D4HAC5AD / D4HAC5D1 / D4HAC5DD / D4HAC6A1 / D4HAC6AD / D4HAC6D1 / D4HAC6DD / D4HBC4A1 / D4HBC5A1 / D4HBC6A1 / D4HHC1A1 / D4HHC2A1 / D4HHC2AD / D4HHC3A1 / D4HHC4A1 / D4HHC4AD / D4HHC5A1 / D4HHC5AD / D4HHC5D1 / D4HHC6A1 / D4HHC6AD / D4HHC6D1 / D4HHC7A1 / D4HLC5A1 / D4HLC6A1 Nabenprofil / Hub Profile: 1 1/2"-10N	(26) (46)	







		CODE				
--	--	------	--	---	---	---

IVECO

EuroCargo		01.91 -				
100 E 15 K	01.91 -	8060		3400 700 449 ■ ⚙ 3482 094 031 ⚙ 1878 000 611 ⚙ 3151 600 544	310 10 MFZ310 310TB KZISZ-3	Getriebenummer / Transmission Number: 2845.6 D4HA31B1 / D4HA32B1 / D4HA32BD / D4HA33B1 / D4HAD1B1 / D4HAD2B1 / D4HAD2BD / D4HAD3B1 / D4HAD3BD Nabenummer / Hub Profile: 1 1/2"-10N (26)
				3400 700 449 ■ ⚙ 3482 094 031 ⚙ 1878 000 611 ⚙ 3151 600 544	310 10 MFZ310 310TB KZISZ-3	Getriebenummer / Transmission Number: 2845.5 D4HAD1A1 / D4HAD2A1 / D4HAD2AD / D4HAD3A1 / D4HAD3AD Nabenummer / Hub Profile: 1 1/2"-10N (46)
100 E 17, 100 E 17 DP tector, 100 E 18 tector	09.00 -	F4AE0481		3400 700 431 ■	330 10	D4PBC6G2 / D4PBC7D1 / D4PBC7D2 / D4PBC7G1 / D4PBC7G2 / D4PBE4D3 / D4PBE5D3 / D4PBE7D3 D4PA04D3 / D4PAC2D1 / D4PAC2DA / D4PAC2G1 / D4PAC2GA / D4PAC3D1 / D4PAC3G1 / D4PAC4D1 / D4PAC4D2 / D4PAC4DA / D4PAC4G1 / D4PAC5D1 / D4PAC5D2 / D4PAC5DA / D4PAC5G1 / D4PAC6D1 / D4PAC6D2 / D4PAC6DA / D4PAC6G1 / D4PAC6G2 / D4PAC7D1 / D4PAC7D2 / D4PAC7DA / D4PAC7DB / D4PAC7G1 / D4PAC7G2 / D4PAE2D3 / D4PAE4D3 / D4PAE5D3 / D4PAE6D3 / D4PAE7D3 / D4PB04D3 / D4PBC2D1 / D4PBC2G1 / D4PBC3D1 / D4PBC3G1 / D4PBC4D1 / D4PBC4G1 / D4PBC5D1 / D4PBC5D2 / D4PBC5G1 / D4PBC5G2 / D4PBC6D1 / D4PBC6D2 / D4PBC6G1 Nabenummer / Hub Profile: 1 1/2"-10N (46)
100 E 17 K tector, 100 E 17 DK tector	09.00 -	F4AE0481		3400 700 431 ■	330 10	D4PBC6G2 / D4PBC7D1 / D4PBC7D2 / D4PBC7G1 / D4PBC7G2 / D4PBE4D3 / D4PBE5D3 / D4PBE7D3 D4PA04D3 / D4PAC1D1 / D4PAC2D1 / D4PAC2DA / D4PAC2G1 / D4PAC2GA / D4PAC3D1 / D4PAC3G1 / D4PAC4D1 / D4PAC4D2 / D4PAC4DA / D4PAC4G1 / D4PAC5D1 / D4PAC5D2 / D4PAC5DA / D4PAC5G1 / D4PAC6D1 / D4PAC6D2 / D4PAC6DA / D4PAC6G1 / D4PAC7D1 / D4PAC7D2 / D4PAC7DA / D4PAC7DB / D4PAC7G1 / D4PAC7G2 / D4PAE2D3 / D4PAE4D3 / D4PAE5D3 / D4PAE6D3 / D4PAE7D3 / D4PB04D3 / D4PBC2D1 / D4PBC2G1 / D4PBC3D1 / D4PBC3G1 / D4PBC4D1 / D4PBC4G1 / D4PBC5D1 / D4PBC5D2 / D4PBC5G1 / D4PBC5G2 / D4PBC6D1 / D4PBC6D2 / D4PBC6G1 Nabenummer / Hub Profile: 1 1/2"-10N (46)
100 E 18, 100 E 18 P	01.91 -	8060		3400 700 449 ■ ⚙ 3482 094 031 ⚙ 1878 000 611 ⚙ 3151 600 544	310 10 MFZ310 310TB KZISZ-3	Getriebenummer / Transmission Number: 2855.6 D4KA12A1 / D4KA12AD / D4KA13A1 / D4KA13AD / D4KA14A1 / D4KA14C1 / D4KA15A1 / D4KA15C1 / D4KA16A1 / D4KA16C1 / D4KAC2A1 / D4KAC2AD / D4KAC3A1 / D4KAC3AD / D4KAC4A1 / D4KAC4AD / D4KAC4C1 / D4KAC4CD / D4KAC5A1 / D4KAC5AD / D4KAC5C1 / D4KAC5CD / D4KAC6A1 / D4KAC6AD / D4KAC6C1 / D4KAC6CD / D4KB14A1 / D4KB14C1 / D4KB15A1 / D4KB16A1 / D4KB16C1 / D4KBC4A1 / D4KBC5A1 / D4KBC6A1 / D4KHC1A1 / D4KHC2A1 / D4KHC2AD / D4KHC4A1 / D4KHC4AD / D4KHC5A1 / D4KHC5AD / D4KHC5D1 / D4KHC5DD / D4KHC6A1 / D4KHC6AD D4KHC6D1 / D4KHC6DD / D4KHC7A1 / D4KHC7AD / D4KHC7D1 / D4KHC7DD / D4KLC5A1 / D4KLC6A1 / D4KLC7A1 / D4KLC7D1 Nabenummer / Hub Profile: 1 1/2"-10N (46)
100 E 18 tector 100 E 18 K tector, 100 E 18 DK tector	09.00 - 09.00 -	F4AE0681		3400 700 430 ■	350 10	D4RAC1G1 / D4RAC2G1 / D4RAC2GA / D4RAC3G1 / D4RAC4G1 / D4RAC4G2 / D4RAC5G1 / D4RAC5G2 / D4RAC6G1 / D4RAC6G2 / D4RAC7G1 / D4RAC7G2 / D4RAE5G3 / D4RAE6G3 / D4RBC2G1 / D4RBC3G1 / D4RBC4G1 / D4RBC4G2 / D4RBC5G1 / D4RBC5G2 / D4RBC6G2 / D4RBC7G2 / D4RCC5G1 / D4RCC6G1 / D4RCC7G1 / D4RCC7G2 Nabenummer / Hub Profile: 1 1/2"-10N (46)
		F4AE0681D, F4AE0681E		3400 700 452 ■	350 10	D4RAC1D1 / D4RAC2D1 / D4RAC2DA / D4RAC3D1 / D4RAC3DA / D4RAC4D1 / D4RAC5D2 / D4RAC4D2 / D4RAC5DA / D4RAC4DA / D4RAC5DB / D4RAC4DB / D4RAC6D1 / D4RAC5D1 / D4RAC6DA / D4RAC7D1 / D4RAC7D2 / D4RAC7DA / D4RAC7DB / D4RAE2D3 / D4RAE6D3 / D4RBC2DA / D4RBC5D1 / D4RBC7D1 / D4RBE6D3 / D4RCC5DA / D4RCC7DA / D4RAE4D3 / D4RAE4DC / D4RAE5D3 / D4RAE5DC / D4RAE7D3 / D4RAE6DC / D4RAE7DC /





		CODE				
--	--	------	--	---	---	---

IVECO

EuroCargo		01.91 -				
100 E 18 K	01.91 -	8060	 3400 700 449 ■ ⊗ 3482 094 031 ⊙ 1878 000 611 ⬤ 3151 600 544	310 10 MFZ310 310TB KZISZ-3	Getriebenummer / Transmission Number: 2855.6 D4KA31A1 / D4KA32A1 / D4KA33A1 / D4KAD1A1 / D4KAD2A1 / D4KAD2AD / D4KAD3A1 / D4KAD3AD / D4KHD1A1 / D4KHD2A1 Nabenprofil / Hub Profile: 1 1/2"-10N	(26)
100 E 18 K tector	09.06 -	F4AE3481B		3400 700 452 ■	350 10 DKRCC6D1 / DKRCC7D1 / DKRCC7D2 / DKRCC7DA / DMREC1E1 DKRAC1D1 / DKRAC2D1 / DKRAC2DA / DKRAC3D1 / DKRAC3DA / DKRAC4D1 / DKRAC4D2 / DKRAC4DA / DKRAC5D1 / DKRAC5D2 / DKRAC5DA / DKRAC5DB / DKRAC6D1 / DKRAC6D2 / DKRAC6DA / DKRAC6DB / DKRAC7D1 / DKRAC7D2 / DKRAC7DA / DKRAC7DB / DKRAE4D4 / DKRAE4DD / DKRAE5D4 / DKRAE5DD / DKRAE6D4 / DKRAE7D4 / DKRAE7DD / DKRBC2D1 / DKRBC2DA / DKRBC3D1 / DKRBC4D1 / DKRBC4D2 / DKRBC5D1 / DKRBC5D2 / DKRBC6D1 / DKRBC6D2 / DKRBC7D1 / DKRBC7D2 / DKRBC7DA / DKRBC7DB / DKRBE4D4 / DKRBE5D4 / DKRBE6D4 / DKRBE7D4 / DKRCC5D1 Nabenprofil / Hub Profile: 1 1/2"-10N	(46)
				3400 700 474 ■	362 10 Getr. / GBox: ZF S5-42 Nabenprofil / Hub Profile: 31,01x38,53-10Z	(46)
				3400 700 475 ■	362 10 Getr. / GBox: ZF 6S 700 T0 Nabenprofil / Hub Profile: 31,02x38,55-10Z	(46)
				3400 700 487 ⊗ 3482 000 419 ⊙ 1878 079 331 ⬤ 3151 000 515	362 10 MF362 362WGTZ KZIS-4	Getr. / GBox: ZF 6AS 700 T0
100 E 18 W tector, 100 E 18 WS tector	09.00 -	F4AE0681		3400 700 430 ■	350 10 D4RAC1G1 / D4RAC2G1 / D4RAC2GA / D4RAC3G1 / D4RAC4G1 / D4RAC4G2 / D4RAC5G1 / D4RAC5G2 / D4RAC6G1 / D4RAC6G2 / D4RAC7G1 / D4RAC7G2 / D4RAE5G3 / D4RAE6G3 / D4RBC2G1 / D4RBC3G1 / D4RBC4G1 / D4RBC4G2 / D4RBC5G1 / D4RBC5G2 / D4RBC6G2 / D4RBC7G2 / D4RCC5G1 / D4RCC6G1 / D4RCC7G2 Nabenprofil / Hub Profile: 1 1/2"-10N	(46)
		F4AE0681E, F4AE3681C		3400 700 452 ■	350 10 D4RBC6D1 / D4RBC6D2 / D4RBC7D2 / D4RBE7D3 / D4RCC6D1 / D4REC1D1 / D4RBC7DA / D4RBC7DB / D4RBE7DC / D4RCC5D1 / D4RCC6D2 / D4RCC7D1 / D4REC2D1 / D4REC2DA D4RAC1D1 / D4RAC2D1 / D4RAC2DA / D4RAC3D1 / D4RAC3DA / D4RAC4D1 / D4RAC5D2 / D4RAC4D2 / D4RAC5DA / D4RAC4DA / D4RAC5DB / D4RAC4DB / D4RAC6D1 / D4RAC5D1 / D4RAC6DA / D4RAC7D1 / D4RAC7D2 / D4RAC7DA / D4RAC7DB / D4RAE2D3 / D4RAE6D3 / D4RBC2DA / D4RBC5D1 / D4RBC7D1 / D4RBE6D3 / D4RCC5DA / D4RCC7DA / D4RAE4D3 / D4RAE4DC / D4RAE5D3 / D4RAE5DC / D4RAE7D3 / D4RAE6DC / D4RAE7DC / D4RBC2D1 / D4RBC3D1 / D4RBC4D1 / D4RBC3DA / D4RBC4D2 / D4RBC6DA / D4RBE5D3 / D4RCC5D2 / D4RCC7D2 / D4REC2H1 / D4RBC5D2 Nabenprofil / Hub Profile: 1 1/2"-10N	(46)
100 E 21, 100 E 21 P	01.91 -	8060	 3400 068 031 ⊗ 3482 093 031 ⊙ 1862 310 132 ⬤ 3151 600 544	330 10 MFZ330 330GSB KZISZ-3	Getriebenummer / Transmission Number: 2865.6 D4LA12A1 / D4LA13A1 / D4LA14A1 / D4LA14C1 / D4LA15A1 / D4LA15C1 / D4LA16A1 / D4LA16C1 / D4LAC2A1 / D4LAC3A1 / D4LAC4A1 / D4LAC4C1 / D4LAC5A1 / D4LAC5C1 / D4LAC6A1 / D4LAC6C1 / D4LB14A1 / D4LB14C1 / D4LB15A1 / D4LB15C1 / D4LB16A1 / D4LB16C1 / D4LBC4C1 / D4LBC5A1 / D4LBC5C1 / D4LHC2A1 / D4LHC3A1 / D4LHC4A1 / D4LHC5A1 / D4LHC5D1 / D4LHC6A1 / D4LHC7A1 / D4LHC7D1 / D4LLC5A1 / D4LLC6A1 / D4LLC7A1 / D4LLC7D1	(26)
100 E 21, 100 E 21 DP tector, 100 E 22 tector	09.00 -	F4AE0681		3400 700 430 ■	350 10 D4SA04D3 / D4SAC1D1 / D4SAC1G1 / D4SAC2D1 / D4SAC2G1 / D4SAC3D1 / D4SAC3G1 / D4SAC4D1 / D4SAC4D2 / D4SAC4DA / D4SAC4G1 / D4SAC4G2 / D4SAC5D1 / D4SAC5D2 / D4SAC5G1 / D4SAC5G2 / D4SAC6D1 / D4SAC6D2 / D4SAC6DA / D4SAC6G1 / D4SAC6G2 / D4SAC7D1 / D4SAC7D2 / D4SAC7DA / D4SAC7G1 / D4SAC7G2 / D4SAC7GB / D4SAE5D3 / D4SAE5G3 / D4SAE6D3 / D4SAE7D3 / D4SAE7G3 / D4SB04D3 / D4SBC2D1 / D4SBC2G1 /	







		CODE				
--	--	------	--	---	---	---

IVECO

EuroCargo		01.91 -					
100 E 21 K tector, 100 E 21 DK tector 100 E 21 W tector, 100 E 21 WS tector	09.00- 09.00-	F4AE0681		3400 700 430 ■ ⊗ 3482 094 031 ⊗ 1878 000 611 ⊙ 3151 600 544	350 10	D4SA04D3 / D4SA07D3 / D4SAC1D1 / D4SAC1G1 / D4SAC2D1 / D4SAC2G1 / D4SAC3D1 / D4SAC3G1 / D4SAC4D1 / D4SAC4D2 / D4SAC4DA / D4SAC4G1 / D4SAC4G2 / D4SAC5D1 / D4SAC5D2 / D4SAC5G1 / D4SAC5G2 / D4SAC6D1 / D4SAC6D2 / D4SAC6DA / D4SAC6G1 / D4SAC6G2 / D4SAC7D1 / D4SAC7D2 / D4SAC7DA / D4SAC7G1 / D4SAC7G2 / D4SAC7GB / D4SAE5D3 / D4SAE5G3 / D4SAE6D3 / D4SAE7D3 / D4SAE7G3 / D4SB04D3 / D4SBC2D1 / D4SBC2G1 / D4SBC3D1 / D4SBC3G1 / D4SBC4D1 / D4SBC4D2 / D4SBC4G1 / D4SBC4G2 / D4SBC5D1 / D4SBC5D2 / D4SBC5DA / D4SBC5G1 / D4SBC5G2 / D4SBC6D1 / D4SBC6D2 / D4SBC6DA / D4SBC6DB / D4SBC6G1 / D4SBC6G2 / D4SBC7D1 / D4SBC7D2 / D4SBC7DA / D4SBC7DB / D4SBC7G1 / D4SBC7G2 / D4SBC7GB / D4SBE4G3 / D4SBE5D3 / D4SBE6D3 / D4SBE7D3 / D4SBE7G3 / D4SCC5D1 / D4SCC5G1 / D4SCC5G2 / D4SCC6D1 / D4SCC6DA / D4SCC6G2 / D4SCC7D1 / D4SCC7D2 / D4SCC7G1 / D4SCC7G2 / D4SEC1D1 / D4SEC1DA / D4SEC2D1 Nabenprofil / Hub Profile: 1 1/2"-10N	(46)
120 E 15	01.91 -	8060		3400 700 449 ■ ⊗ 3482 094 031 ⊗ 1878 000 611 ⊙ 3151 600 544	310 10 MFZ310 310TB KZISZ-3	Getriebenummer / Transmission Number: 2845.6 E0BA11B1 / E0BA12B1 / E0BA13B1 / E0BA14B1 / E0BA15B1 / E0BA16B1 / E0BA17B1 / E0BAC1B1 / E0BAC1BD / E0BAC2B1 / E0BAC2BD / E0BAC2ED / E0BAC3B1 / E0BAC3BD / E0BAC3ED / E0BAC4B1 / E0BAC4BD / E0BAC4ED / E0BAC5B1 / E0BAC5BD / E0BAC5ED / E0BAC6B1 / E0BAC6BD / E0BAC6ED / E0BAC7B1 / E0BAC7BD / E0BAC7ED / E0BBC3BD / E0BBC3ED / E0BBC7BD / E0HHC4B1 / E0HHC5B1 / E0HHC5BD / E0HHC6B1 / E0HHC6BD / E0HHC7B1 / E0HHC7BD / E0HHC8BD / E0HHC9BD Nabenprofil / Hub Profile: 1 1/2"-10N	(26)
				3400 700 449 ■ ⊗ 3482 094 031 ⊗ 1878 000 611 ⊙ 3151 600 544	310 10 MFZ310 310TB KZISZ-3	Getriebenummer / Transmission Number: 2845.5 E0BAC1A1 / E0BAC2A1 / E0BAC3A1 / E0BAC3DD / E0BAC4A1 / E0BAC5A1 / E0BAC5AD / E0BAC6A1 / E0BAC7A1 / E0BAC7AD / E0BBC3A1 / E0BBC3AD / E0BBC3D1 / E0BBC3DD / E0BBC5A1 / E0BBC5AD / E0BBC6AD / E0BBC6D1 / E0BBC7A1 / E0BBC7AD / E0HHC5A1 / E0HHC6A1 / E0HHC7A1 / E0HHC8A1 Nabenprofil / Hub Profile: 1 1/2"-10N	(26)
120 E 15 K	01.92 -	8060		3400 700 449 ■ ⊗ 3482 094 031 ⊗ 1878 000 611 ⊙ 3151 600 544	310 10 MFZ310 310TB KZISZ-3	Getriebenummer / Transmission Number: 2845.6 E0BAD1B1 / E0BAD1BD / E0BAD2B1 / E0BAD2BD Nabenprofil / Hub Profile: 1 1/2"-10N	(26)
				3400 700 449 ■ ⊗ 3482 094 031 ⊗ 1878 000 611 ⊙ 3151 600 544	310 10 MFZ310 310TB KZISZ-3	Getriebenummer / Transmission Number: 2845.5 E0BAD1A1 / E0BAD1AD / E0BAD2A1 / E0BAD2AD Nabenprofil / Hub Profile: 1 1/2"-10N	(26)
120 E 18, 120 E 18 P, 120 E 18 H	01.92 -	8060		3400 700 449 ■ ⊗ 3482 094 031 ⊗ 1878 000 611 ⊙ 3151 600 544	310 10 MFZ310 310TB KZISZ-3	Getriebenummer / Transmission Number: 2870.9 E0CB15B1 / E0CB15E1 / E0CB16B1 / E0CB16E1 / E0CB17B1 / E0CB17E1 / E0CBC5BD / E0CBC6BD / E0KLC7B1 / E0KLC7E1 / E0KLC9E1 / E0KMC5E1 / E0KMC8B1 / E0KMC8E1 / E0KHC2B1 / E0KHC4B1 / E0KHC4E1 / E0KHC5B1 / E0KHC6B1 / E0KHC7B1 / E0KHC7E1 / E0KHC8B1 / E0KHC8E1 / E0KHC9B1 / E0KHC9E1 / E0KLC5B1 / E0KLC5E1 / E0CA11B1 / E0CA11BD / E0CA12B1 / E0CA12E1 / E0CA13B1 / E0CA13E1 / E0CA14B1 / E0CA14BD / E0CA14E1 / E0CA15B1 / E0CA15E1 / E0CA16B1 / E0CA16BD / E0CA16E1 / E0CA16ED / E0CA17B1 / E0CA17E1 / E0CAC1B1 / E0CAC2B1 / E0CAC2E1 / E0CAC3B1 / E0CAC3E1 / E0CAC4B1 / E0CAC4E1 / E0CAC5B1 / E0CAC5E1 / E0CAC6B1 / E0CAC6E1 / E0CAC7B1 / E0CAC7E1 / E0CB13B1 / E0CB13E1 Nabenprofil / Hub Profile: 1 1/2"-10N	(26)
				3400 700 449 ■ ⊗ 3482 094 031 ⊗ 1878 000 611 ⊙ 3151 600 544	310 10 MFZ310 310TB KZISZ-3	Getriebenummer / Transmission Number: 2855.6 E0CCC3A1 / E0CCC5A1 / E0CCC6A1 / E0CCC6D1 / E0CCC7A1 / E0CCC7D1 / E0KHC2A1 / E0KHC4A1 / E0KHC4AD / E0KHC4D1 / E0KHC5A1 / E0KHC5AD / E0KHC6A1 / E0KHC6AD / E0KHC7A1 / E0KHC7AD / E0KHC7D1 / E0KHC8A1 / E0KHC8AD / E0KHC9A1 / E0KHC9D1 / E0KHC9DD / E0KLC5A1 / E0KLC7A1 / E0KLC7AD /	(26)

		CODE				
--	--	------	--	---	---	---

IVECO

EuroCargo		01.91 -							
120 E 18 tector, 120 E 18 D tector, 120 E 18 DP tector 120 E 18 K tector, 120 E 18 DK tector	09.00-	Tector6F4AE06 81E		3400 700 430 ■	350 10	02.2001-> Getriebenummer / Transmission Number: 2870.9 Getr. / GBox: Iveco 9-Gear Nabenprofil / Hub Profile: 1 1/2"-10N	(26)		
	09.00-			3400 700 431 ■	330 10	02.2001-> Getriebenummer / Transmission Number: 2855.6 Getr. / GBox: Iveco 6-Gear Nabenprofil / Hub Profile: 1 1/2"-10N	(46)		
120 E 18 K	01.92-	8060		3400 700 449 ■ ⊗ 3482 094 031 ⊗ 1878 000 611 ⊙ 3151 600 544	310 10 MFZ310 310TB KZISZ-3	Getriebenummer / Transmission Number: 2870.9 E0CA31B1 / E0CA32B1 / E0CAD1B1 Nabenprofil / Hub Profile: 1 1/2"-10N	(26)		
				3400 700 449 ■ ⊗ 3482 094 031 ⊗ 1878 000 611 ⊙ 3151 600 544	310 10 MFZ310 310TB KZISZ-3	Getriebenummer / Transmission Number: 2855.6 E0CAD1A1 / E0CAD2A1 Nabenprofil / Hub Profile: 1 1/2"-10N	(46)		
120 EL 21, 120 EL 21 P tector, 120 E 22, 120 EL 22 tector	09.00-	F4AE0681D, F4AE3681B, F4AE0681C		3400 700 430 ■	350 10	Getriebenummer / Transmission Number: 2870.9 Getr. / GBox: Iveco 9-Gear Nabenprofil / Hub Profile: 1 1/2"-10N	(26)		
				3400 700 430 ■	350 10	Getriebenummer / Transmission Number: 2865.6 Getr. / GBox: Iveco 6-Gear Nabenprofil / Hub Profile: 1 1/2"-10N	(46)		
120 E 23, 120 E 23 P, 120 E 23 FP, 120 E 23 H	01.92-	8060		3400 068 031 ⊗ 3482 093 031 ⊗ 1862 310 132 ⊙ 3151 600 544	330 10 MFZ330 330GSB KZISZ-3	Getriebenummer / Transmission Number: 2870.9 E0DC13E1 / E0DC15B1 / E0DC15E1 / E0DC16B1 / E0DC16E1 / E0DC17B1 / E0DC17E1 / E0DCC3B1 / E0DCC3E1 / E0DCC5B1 / E0DCC5E1 / E0DCC6B1 / E0DCC6E1 / E0DCC7B1 / E0DCC7E1 / E0MHC4B1 / E0MHC5B1 / E0MHC5E1 / E0MHC6B1 / E0MHC6E1 / E0MHC7B1 / E0MHC7E1 / E0MHC8E1 / E0MHC9B1 / E0MHC9E1 / E0MLC5B1 / E0MLC5E1 / E0MLC7B1 / E0MLC7E1 / E0MLC8B1 / E0MLC8E1 / E0MLC9B1 / E0MLC9E1 / E0MMC9E1 / E0DA11B1 / E0DA12B1 / E0DA12E1 / E0DA13B1 / E0DA13E1 / E0DA14B1 / E0DA14E1 / E0DA15B1 / E0DA15E1 / E0DA16B1 / E0DA16E1 E0DA17B1 / E0DA17E1 / E0DA17ED / E0DAC1B1 / E0DAC2B1 / E0DAC2E1 / E0DAC3B1 / E0DAC3E1 / E0DAC4B1 / E0DAC4E1 / E0DAC5B1 / E0DAC5E1 / E0DAC6B1 / E0DAC6E1 / E0DAC7B1 / E0DAC7E1 / E0DB13B1 / E0DB13E1 / E0DB15B1 / E0DB15E1 / E0DB16B1 / E0DB16E1 / E0DB17B1 / E0DB17BD / E0DB17E1 / E0DBC3B1 / E0DBC3E1 / E0DBC5B1 / E0DBC5E1 / E0DBC6B1 / E0DBC6E1 / E0DBC7B1 / E0DBC7E1 / E0DC13B1	330 10 MFZ330 330GSB KZISZ-3	Getriebenummer / Transmission Number: 2865.6 E0MHC2A1 / E0MHC4A1 / E0MHC8D1 / E0MHC9A1 / E0MHC9D1 / E0MLC7A1 / E0DAC1A1 / E0DAC2A1 / E0DAC3A1 / E0DAC3D1 / E0DAC4A1 / E0DAC4D1 / E0DAC5A1 / E0DAC5D1 / E0DAC6A1 / E0DAC6D1 / E0DAC7A1 / E0DAC7D1 / E0DBC3A1 / E0DBC3D1 / E0DBC5A1 / E0DBC5D1 / E0DBC7A1 / E0DBC7D1	(26)
				3400 068 031 ⊗ 3482 093 031 ⊗ 1862 310 132 ⊙ 3151 600 544	330 10 MFZ330 330GSB KZISZ-3	Getriebenummer / Transmission Number: 2895.9 Getr. / GBox: Iveco 9-Gear	(26)		
120 E 24, 120 E 24 DP tector, 120 E 25 tector 120 E 24 K tector, 120 E 24 DK tector	09.00-	F4AE3681D, F4AE0681B		3400 074 031 ⊗ 3482 078 134 ⊗ 1862 308 031 ⊙ 3151 000 144	400 10 MFZ400 380GSZ KZISZ-5	Getriebenummer / Transmission Number: 2895.9 Getr. / GBox: Iveco 9-Gear	(26)		
	09.00-			3400 074 031 ⊗ 3482 078 134 ⊗ 1862 308 031 ⊙ 3151 000 144	400 10 MFZ400 380GSZ KZISZ-5	Getriebenummer / Transmission Number: 2870.9 E5BA12BD / E5BAC1B1 / E5BAC2B1 / E5BAC2E1 / E5BAC4B1 / E5BAC5B1 / E5BBC3ED / E5BBC7BD Nabenprofil / Hub Profile: 1 1/2"-10N	(46)		
130 E 15	01.94-	8060		3400 700 449 ■ ⊗ 3482 094 031 ⊗ 1878 000 611 ⊙ 3151 600 544	310 10 MFZ310 310TB KZISZ-3	Getriebenummer / Transmission Number: 2845.6 E1HHC2A1 / E1HHC2AD / E1HHC4A1 / E1HHC5AD / E1HHC6AD / E1HHC7A1 / E1HHC7AD / E1HHC8A1 / E1HHC8AD / E1HHC9AD / E5BAC1A1 / E5BAC1AD / E5BAC2A1 / E5BAC2AD / E5BAC2D1 / E5BAC2DD / E5BAC3A1 / E5BAC3AD / E5BAC3D1 / E5BAC3DD / E5BAC4A1 / E5BAC4AD / E5BAC4D1 / E5BAC4DD / E5BAC5A1 / E5BAC5AD / E5BAC5D1 / E5BAC5DD / E5BAC6A1 / E5BAC6AD / E5BAC6D1 / E5BAC7A1 / E5BAC7AD / E5BAC7D1 / E5BAC7DD / E5BBC3AD / E5BBC3DD / E5BBC5AD / E5BBC5DD / E5BBC6DD Nabenprofil / Hub Profile: 1 1/2"-10N	(26)		
				3400 700 449 ■ ⊗ 3482 094 031 ⊗ 1878 000 611 ⊙ 3151 600 544	310 10 MFZ310 310TB KZISZ-3	Getriebenummer / Transmission Number: 2845.6 E5BAD1A1 / E5BAD1AD / E5BAD2A1 / E5BAD2AD Nabenprofil / Hub Profile: 1 1/2"-10N	(46)		
130 E 15 K	01.94-	8060		3400 700 449 ■ ⊗ 3482 094 031 ⊗ 1878 000 611 ⊙ 3151 600 544	310 10 MFZ310 310TB KZISZ-3	Getriebenummer / Transmission Number: 2845.6 E5BAD1A1 / E5BAD1AD / E5BAD2A1 / E5BAD2AD Nabenprofil / Hub Profile: 1 1/2"-10N	(46)		













		CODE				
--	--	------	--	---	---	---

IVECO

EuroCargo		01.91 -					
130 E 18	01.92-	8060		3400 700 449   3482 094 031  1878 000 611  3151 600 544	310 10 MFZ310 310TB KZISZ-3	Getriebenummer / Transmission Number: 2870.9 E1KHC2B1 / E1KHC4B1 / E1KHC5B1 / E1KHC6B1 / E1KHC7B1 / E1KHC7E1 / E1KHC8B1 / E1KLC5B1 / E1KLC7B1 / E5CA11B1 / E5CA12B1 / E5CA12BD / E5CA13B1 / E5CA13E1 / E5CA14B1 / E5CA14E1 / E5CA15B1 / E5CA15BD / E5CA15E1 / E5CA16B1 / E5CA16E1 / E5CA17B1 / E5CAC1B1 / E5CAC2B1 / E5CAC3B1 / E5CAC3E1 / E5CAC4B1 / E5CAC4E1 / E5CAC5B1 / E5CAC5E1 / E5CAC6B1 / E5CAC6E1 / E5CAC7B1 / E5CAC7E1 / E5CB13B1 / E5CB15B1 / E5CB15E1 / E5CB16B1 / E5CB16E1 / E5CB17B1 / E5CBC3B1 / E5CBC5B1 / E5CBC5E1 / E5CBC6E1 / E5CBC7E1 Nabenprofil / Hub Profile: 1 1/2"-10N	(26)
				3400 700 449   3482 094 031  1878 000 611  3151 600 544	310 10 MFZ310 310TB KZISZ-3	Getriebenummer / Transmission Number: 2855.6 E1KHC2A1 / E1KHC2AD / E1KHC4A1 / E1KHC5A1 / E1KHC6A1 / E1KHC7A1 / E1KHC8A1 / E1KHC8AD / E1KHC9A1 / E1KHC9AD / E1KHC9DD / E1KLC8AD / E1KLC9DD / E5CAC1A1 / E5CAC1AD / E5CAC2A1 / E5CAC2AD / E5CAC2D1 / E5CAC3A1 / E5CAC3AD / E5CAC3DD / E5CAC4A1 / E5CAC4AD / E5CAC4D1 / E5CAC5A1 / E5CAC5AD / E5CAC5D1 / E5CAC5DD / E5CAC6A1 / E5CAC6AD / E5CAC6D1 / E5CAC6DD / E5CAC7A1 / E5CAC7AD / E5CAC7D1 / E5CAC7DD / E5CBC3A1 / E5CBC3AD / E5CBC5A1 / E5CBC6A1 / E5CBC6D1 / E5CBC7A1 / E5CBC7D1 Nabenprofil / Hub Profile: 1 1/2"-10N	(46)
130 E 18 tector, 130 E 18 D tector, 130 E 18 DP tector 130 E 18 K tector, 130 E 18 DK tector	09.00- 09.00-	F4AE0681		3400 700 430   3482 094 031  1878 000 611  3151 600 544	350 10 E4RA72D1 / E4RAC2G1 / E4RAC2GA / E4RAC4G1 / E4RAC4GA / E4RAC5G1 / E4RAC6G1 / E4RAC7G1 / E4RAC7G2 / E4RAC8G1 / E4RAC8G2 / E4RAC9G1 / E4RAC9G2 / E4RACBG1 / E4RACBGB / E4RAE5G3 / E4RAE6G3 / E4RAE7G3 / E4RBC2G1 / E4RBC4G1 / E4RBC5G1 / E4RBC5G2 / E4RBC6G1 / E4RBC6G2 / E4RBC7G1 / E4RBC7G2 / E4RBC8G1 / E4RBC8G2 / E4RBC9G1 / E4RBC9G2 / E4RBCBG2 / E4RBE6G3 / E4RCC5G1 / E4RCC6G1 / E4RCC7G1 / E4RCC8G2 / E4RCC9G2 Nabenprofil / Hub Profile: 1 1/2"-10N	(46)	
				3400 700 452   3482 094 031  1878 000 611  3151 600 544	350 10 E4RBC7D1 / E4RBC7D2 / E4RBC8D1 / E4RBC8D2 / E4RBC8DA / E4RBC9D1 / E4RBC9D2 / E4RBC9DA / E4RBCBD1 / E4RBCBD2 / E4RBCBDA / E4RBE5D3 / E4RBE7D3 / E4RCC5D1 / E4RCC5D2 / E4RCC6D1 / E4RCC7D1 / E4RCC7D2 / E4RCC7DA / E4RCC8D1 / E4RCC9D1 / E4RCCBD1 E4RAC2D1 / E4RAC2DA / E4RAC4D1 / E4RAC4D2 / E4RAC4DA / E4RAC4DB / E4RAC5D1 / E4RAC5D2 / E4RAC5DA / E4RAC5DB / E4RAC6D1 / E4RAC6D2 / E4RAC6DA / E4RAC7D1 / E4RAC7D2 / E4RAC7DA / E4RAC7DB / E4RAC8D1 / E4RAC8D2 / E4RAC8DA / E4RAC8DB / E4RAC9D1 / E4RAC9D2 / E4RAC9DA / E4RAC9DB / E4RACBD1 / E4RACBDA / E4RACBDB / E4RAE4D3 / E4RAE5D3 / E4RAE6D3 / E4RAE6DC / E4RAE7D3 / E4RAE8D3 / E4RAE8DC / E4RBC2D1 / E4RBC2DA / E4RBC4D1 / E4RBC4DA / E4RBC5D1 / E4RBC5D2 / E4RBC5DA / E4RBC6D1 / E4RBC6DA / E4RBC6DB Nabenprofil / Hub Profile: 1 1/2"-10N	(46)	
130 E 18 D tector, 130 E 18 DP tector	09.06-	F4AE3481A		3400 700 452   3482 094 031  1878 000 611  3151 600 544	350 10 EKRAC2D1 / EKRAC2DA / EKRAC4D1 / EKRAC4DA / EKRAC4DB / EKRAC5D1 / EKRAC5DA / EKRAC5DB / EKRAC6D1 / EKRAC6D2 / EKRAC6DA / EKRAC7D1 / EKRAC7D2 / EKRAC7DA / EKRAC7DB / EKRAC8D1 / EKRAC8D2 / EKRAC8DA / EKRAC8DB / EKRAC9D1 / EKRAC9D2 / EKRAC9DA / EKRAC9DB / EKRACBD1 / EKRACBD2 / EKRACBDA / EKRACBDB / EKRAE4D4 / EKRAE5D4 / EKRAE5DD / EKRAE6D4 / EKRAE6DD / EKRAE7D4 / EKRAE7DD / EKRAE8D4 / EKRAE8DD / EKRBC2D1 / EKRBC2DA / EKRBC4D1 / EKRBC4DA / EKRBC5D1 / EKRBC5DA / EKRBC6D1 / EKRBC6D2 / EKRBC7D1 / EKRBC7D2 / EKRBC8D1 / EKRBC8D2 / EKRBC8DA / EKRBC8DB / EKRBC9D1 / EKRBC9D2 / EKRBC9DA / EKRBC9DB / EKRBCBD1 / EKRBE7D4 / EKRBE8D4 /		







		CODE				
--	--	------	--	---	---	---

IVECO

EuroCargo		01.91 -					
130 E 18 K	01.92-	8060	 <ul style="list-style-type: none"> 3400 700 449 ■ ⊗ 3482 094 031 ⊗ 1878 000 611 ⬢ 3151 600 544 	310 10 MFZ310 310TB KZISZ-3	Getriebenummer / Transmission Number: 2855.6 E5CAD1A1 / E5CAD2A1 Nabenprofil / Hub Profile: 1 1/2"-10N	(26) (46)	
130 E 23	01.92-	8060	 <ul style="list-style-type: none"> 3400 068 031 ⊗ 3482 093 031 ⊗ 1862 310 132 ⬢ 3151 600 544 	330 10 MFZ330 330GSB KZISZ-3	Getriebenummer / Transmission Number: 2865.6 E1MHC7A1 / E5DAC1A1 / E5DAC2A1 / E5DAC2D1 / E5DAC3A1 / E5DAC3D1 / E5DAC4A1 / E5DAC5A1 / E5DAC5D1 / E5DAC6A1 / E5DAC6D1 / E5DAC7A1 / E5DAC7D1	(26)	
			 <ul style="list-style-type: none"> 3400 068 031 ⊗ 3482 093 031 ⊗ 1862 310 132 ⬢ 3151 600 544 	330 10 MFZ330 330GSB KZISZ-3	Getriebenummer / Transmission Number: 2870.9 E1MHC5B1 / E1MHC6B1 / E1MHC7B1 / E1MHC7E1 / E1MHC8E1 / E1MHC9B1 / E1MHC9E1 / E1MLC5B1 / E1MLC7B1 / E1MLC7E1 / E1MLC8B1 / E1MLC8E1 / E5DA12B1 / E5DA13B1 / E5DA14B1 / E5DA14E1 / E5DA15B1 / E5DA15E1 / E5DA16B1 / E5DA16E1 / E5DA17B1 / E5DA17E1 / E5DAC1B1 / E5DAC2B1 / E5DAC3B1 / E5DAC3E1 / E5DAC4B1 / E5DAC4E1 / E5DAC5B1 / E5DAC5E1 / E5DAC6B1 / E5DAC6E1 / E5DAC7B1 / E5DAC7E1 / E5DB13B1 / E5DB13E1 / E5DB15B1 / E5DB15E1 / E5DB16B1 / E5DB16E1 / E5DB17E1 / E5DBC3B1 / E5DBC3E1 / E5DBC5B1 / E5DBC5E1 / E5DBC6E1 / E5DBC7B1 / E5DBC7E1 / E5DC13E1 / E5DC15B1 / E5DC16BD / E5DC17B1 / E5DC17E1 / E5DCC5B1 / E5DCC5E1 / E5DCC6B1	(26)	
			 <ul style="list-style-type: none"> 3400 700 449 ■ ⊗ 3482 094 031 ⊗ 1878 000 611 ⬢ 3151 600 544 	310 10 MFZ310 310TB KZISZ-3	Getriebenummer / Transmission Number: 2870.9 E1MHC4B1 Nabenprofil / Hub Profile: 1 1/2"-10N	(26) (46)	
			 <ul style="list-style-type: none"> 3400 700 449 ■ ⊗ 3482 094 031 ⊗ 1878 000 611 ⬢ 3151 600 544 	310 10 MFZ310 310TB KZISZ-3	Getriebenummer / Transmission Number: 2865.6 E1MHC4A1 Nabenprofil / Hub Profile: 1 1/2"-10N	(26) (46)	
			 <ul style="list-style-type: none"> 3400 068 031 ⊗ 3482 093 031 ⊗ 1862 310 132 ⬢ 3151 600 544 	330 10 MFZ330 330GSB KZISZ-3	->Chass. 2253628 Getriebenummer / Transmission Number: ZF S6.36 OD+N36/10 E1MHC4A1 / E1MHC4B1	(26)	
130 E 24 tector, 130 E 24 D tector, 130 E 24 DP tector 130 E 24 K tector, 130 E 24 DK tector	09.00- 09.00-	F4AE0681	 <ul style="list-style-type: none"> 3400 074 031 ⊗ 3482 078 134 ⊗ 1862 308 031 ⬢ 3151 000 144 	400 10 MFZ400 380GSZ KZISZ-5	E4TAC2G1 / E4TAC4G1 / E4TAC5G1 / E4TAC5G2 / E4TAC6G1 / E4TAC6G2 / E4TAC7G1 / E4TAC7G2 / E4TAC7GA / E4TAC8G1 / E4TAC8G2 / E4TAC8GA / E4TAC8GB / E4TAC9G1 / E4TAC9G2 / E4TAC9G3 / E4TAC9G4 / E4TAC9G5 / E4TAC9G6 / E4TAC9G7 / E4TAC9G8 / E4TAC9G9 / E4TAC9G10 / E4TAC9G11 / E4TAC9G12 / E4TAC9G13 / E4TAC9G14 / E4TAC9G15 / E4TAC9G16 / E4TAC9G17 / E4TAC9G18 / E4TAC9G19 / E4TAC9G20 / E4TAC9G21 / E4TAC9G22 / E4TAC9G23 / E4TAC9G24 / E4TAC9G25 / E4TAC9G26 / E4TAC9G27 / E4TAC9G28 / E4TAC9G29 / E4TAC9G30 / E4TAC9G31 / E4TAC9G32 / E4TAC9G33 / E4TAC9G34 / E4TAC9G35 / E4TAC9G36 / E4TAC9G37 / E4TAC9G38 / E4TAC9G39 / E4TAC9G40 / E4TAC9G41 / E4TAC9G42 / E4TAC9G43 / E4TAC9G44 / E4TAC9G45 / E4TAC9G46 / E4TAC9G47 / E4TAC9G48 / E4TAC9G49 / E4TAC9G50 / E4TAC9G51 / E4TAC9G52 / E4TAC9G53 / E4TAC9G54 / E4TAC9G55 / E4TAC9G56 / E4TAC9G57 / E4TAC9G58 / E4TAC9G59 / E4TAC9G60 / E4TAC9G61 / E4TAC9G62 / E4TAC9G63 / E4TAC9G64 / E4TAC9G65 / E4TAC9G66 / E4TAC9G67 / E4TAC9G68 / E4TAC9G69 / E4TAC9G70 / E4TAC9G71 / E4TAC9G72 / E4TAC9G73 / E4TAC9G74 / E4TAC9G75 / E4TAC9G76 / E4TAC9G77 / E4TAC9G78 / E4TAC9G79 / E4TAC9G80 / E4TAC9G81 / E4TAC9G82 / E4TAC9G83 / E4TAC9G84 / E4TAC9G85 / E4TAC9G86 / E4TAC9G87 / E4TAC9G88 / E4TAC9G89 / E4TAC9G90 / E4TAC9G91 / E4TAC9G92 / E4TAC9G93 / E4TAC9G94 / E4TAC9G95 / E4TAC9G96 / E4TAC9G97 / E4TAC9G98 / E4TAC9G99 / E4TAC9G100		
130 E 28 tector 130 E 28 K tector	09.00- 09.00-	F4AE0681	 <ul style="list-style-type: none"> 3400 074 031 ⊗ 3482 078 134 ⊗ 1862 308 031 ⬢ 3151 000 144 	400 10 MFZ400 380GSZ KZISZ-5	E4UAC2G1 / E4UAC4G1 / E4UAC5G1 / E4UAC5G2 / E4UAC6G1 / E4UAC6G2 / E4UAC7G1 / E4UAC7G2 / E4UAC7GA / E4UAC8G1 / E4UAC8G2 / E4UAC8GA / E4UAC8GB / E4UAC9G1 / E4UAC9G2 / E4UAC9G3 / E4UAC9G4 / E4UAC9G5 / E4UAC9G6 / E4UAC9G7 / E4UAC9G8 / E4UAC9G9 / E4UAC9G10 / E4UAC9G11 / E4UAC9G12 / E4UAC9G13 / E4UAC9G14 / E4UAC9G15 / E4UAC9G16 / E4UAC9G17 / E4UAC9G18 / E4UAC9G19 / E4UAC9G20 / E4UAC9G21 / E4UAC9G22 / E4UAC9G23 / E4UAC9G24 / E4UAC9G25 / E4UAC9G26 / E4UAC9G27 / E4UAC9G28 / E4UAC9G29 / E4UAC9G30 / E4UAC9G31 / E4UAC9G32 / E4UAC9G33 / E4UAC9G34 / E4UAC9G35 / E4UAC9G36 / E4UAC9G37 / E4UAC9G38 / E4UAC9G39 / E4UAC9G40 / E4UAC9G41 / E4UAC9G42 / E4UAC9G43 / E4UAC9G44 / E4UAC9G45 / E4UAC9G46 / E4UAC9G47 / E4UAC9G48 / E4UAC9G49 / E4UAC9G50 / E4UAC9G51 / E4UAC9G52 / E4UAC9G53 / E4UAC9G54 / E4UAC9G55 / E4UAC9G56 / E4UAC9G57 / E4UAC9G58 / E4UAC9G59 / E4UAC9G60 / E4UAC9G61 / E4UAC9G62 / E4UAC9G63 / E4UAC9G64 / E4UAC9G65 / E4UAC9G66 / E4UAC9G67 / E4UAC9G68 / E4UAC9G69 / E4UAC9G70 / E4UAC9G71 / E4UAC9G72 / E4UAC9G73 / E4UAC9G74 / E4UAC9G75 / E4UAC9G76 / E4UAC9G77 / E4UAC9G78 / E4UAC9G79 / E4UAC9G80 / E4UAC9G81 / E4UAC9G82 / E4UAC9G83 / E4UAC9G84 / E4UAC9G85 / E4UAC9G86 / E4UAC9G87 / E4UAC9G88 / E4UAC9G89 / E4UAC9G90 / E4UAC9G91 / E4UAC9G92 / E4UAC9G93 / E4UAC9G94 / E4UAC9G95 / E4UAC9G96 / E4UAC9G97 / E4UAC9G98 / E4UAC9G99 / E4UAC9G100		
135 E 18 W	01.97-	8060	 <ul style="list-style-type: none"> 3400 700 449 ■ ⊗ 3482 094 031 ⊗ 1878 000 611 ⬢ 3151 600 544 	310 10 MFZ310 310TB KZISZ-3	Getriebenummer / Transmission Number: 2865.6 E3KPC1A1 / E3KPC2A1 / E3KPC2AD / E3KPC3A1 / E3KPC3AD Nabenprofil / Hub Profile: 1 1/2"-10N	(26) (46)	
135 E 18 WR	01.93- 12.96	8060	 <ul style="list-style-type: none"> 3400 700 449 ■ ⊗ 3482 094 031 ⊗ 1878 000 611 ⬢ 3151 600 544 	310 10 MFZ310 310TB KZISZ-3	Getriebenummer / Transmission Number: 2865.6 E1CE11A1 / E1CE11AD / E1CE12A1 / E1CE12AD / E1CE13A1 / E1CE13AD Nabenprofil / Hub Profile: 1 1/2"-10N	(26) (46)	
135 E 23 W	01.97-	8060	 <ul style="list-style-type: none"> 3400 068 031 ⊗ 3482 093 031 ⊗ 1862 310 132 ⬢ 3151 600 544 	330 10 MFZ330 330GSB KZISZ-3	->Chass. 2253628 Getriebenummer / Transmission Number: S6-36/2-5 E3MPC2C1	(26)	
			 <ul style="list-style-type: none"> 3400 068 031 ⊗ 3482 093 031 ⊗ 1862 310 132 ⬢ 3151 600 544 	330 10 MFZ330 330GSB KZISZ-3	->Chass. 2253628 Getriebenummer / Transmission Number: 2865.6 E3MPC1A1 / E3MPC1AD / E3MPC2A1 / E3MPC3A1 / E3MPC3AD	(26)	







		CODE				
--	--	------	--	---	---	---

IVECO

EuroCargo		01.91 -				
135 E 23 WR	01.93 - 12.96	8060	 3400 068 031 ⊗ 3482 093 031 ⊗ 1862 310 132 ⊙ 3151 600 544	330 10 MFZ330 330GSB KZISZ-3	->Chass. 2253628 Getriebenummer / Transmission Number: 2865.6 E1DE11A1 / E1DE11AD / E1DE12A1 / E1DE12AD / E1DE13A1 / E1DE13AD	(26)
140 E 18 W tector	09.00 -	Tector6F4AE06 81E	 3400 700 430 ■	350 10	06.2003-> Getriebenummer / Transmission Number: 2865.6 Getr. / GBox: Iveco 6-Gear Nabenprofil / Hub Profile: 1 1/2"-10N	(26) (46)
150 E 15	01.92 - 12.96	8060	 3400 700 449 ■ ⊗ 3482 094 031 ⊗ 1878 000 611 ⊙ 3151 600 544	310 10 MFZ310 310TB KZISZ-3	Getriebenummer / Transmission Number: 2870.9 E2BAC1BD / E2BAC2BD / E2BAC2ED / E2BAC5BD / E2BAC6BD Nabenprofil / Hub Profile: 1 1/2"-10N	(26) (46)
				310 10 MFZ310 310TB KZISZ-3	Getriebenummer / Transmission Number: 2845.6 E2BAC1AD / E2BAC2A1 / E2BAC2AD / E2BAC2DD / E2BAC3A1 / E2BAC3AD / E2BAC4A1 / E2BAC4AD / E2BAC4DD / E2BAC5A1 / E2BAC5AD / E2BAC6A1 / E2BAC6AD / E2BAC7A1 / E2BAC7AD / E2BAC7D1 / E2BAC7DD / E2BAC5AD / E2HHC7AD / E2HHC8AD / E2HHC9AD Nabenprofil / Hub Profile: 1 1/2"-10N	(26) (46)
150 E 15 K	01.92 - 12.96	8060	 3400 700 449 ■ ⊗ 3482 094 031 ⊗ 1878 000 611 ⊙ 3151 600 544	310 10 MFZ310 310TB KZISZ-3	Getriebenummer / Transmission Number: 2845.6 E2BAD1A1 / E2BAD1AD / E2BAD2A1 Nabenprofil / Hub Profile: 1 1/2"-10N	(26) (46)
150 E 18, 150 E 18 P	01.92 -	8060	 3400 700 449 ■ ⊗ 3482 094 031 ⊗ 1878 000 611 ⊙ 3151 600 544	310 10 MFZ310 310TB KZISZ-3	Getriebenummer / Transmission Number: 2865.6 E2CAC1A1 / E2CAC1AD / E2CAC2A1 / E2CAC2AD / E2CAC2D1 / E2CAC2DD / E2CAC3A1 / E2CAC3AD / E2CAC3D1 / E2CAC4A1 / E2CAC4AD / E2CAC4D1 / E2CAC4DD / E2CAC5A1 / E2CAC5AD / E2CAC5D1 / E2CAC5DD / E2CAC6A1 / E2CAC6AD / E2CAC6D1 / E2CAC6DD / E2CAC7A1 / E2CAC7AD / E2CAC7D1 / E2CAC7DD / E2CBC5A1 / E2CBC6A1 / E2CBC7A1 / E2KHC2A1 / E2KHC2AD / E2KHC4A1 / E2KHC5A1 / E2KHC6A1 / E2KHC7A1 / E2KHC7AD / E2KHC7D1 / E2KHC8A1 / E2KHC8AD / E2KHC9A1 / E2KHC9AD / E2KHC9DD Nabenprofil / Hub Profile: 1 1/2"-10N	(26) (46)
				310 10 MFZ310 310TB KZISZ-3	Getriebenummer / Transmission Number: 2870.9 E2CA11B1 / E2CA12B1 / E2CA12E1 / E2CA13B1 / E2CA13E1 / E2CA14B1 / E2CA14E1 / E2CA15B1 / E2CA15E1 / E2CA16B1 / E2CA16E1 / E2CA17B1 / E2CA17E1 / E2CAC1B1 / E2CAC1BD / E2CAC2B1 / E2CAC2BD / E2CAC2E1 / E2CAC3B1 / E2CAC3BD / E2CAC3E1 / E2CAC4B1 / E2CAC4BD / E2CAC4E1 / E2CAC5B1 / E2CAC5BD / E2CAC5E1 / E2CAC5ED / E2CAC6B1 / E2CAC6BD / E2CAC6E1 / E2CAC6ED / E2CAC7B1 / E2CAC7BD / E2CAC7E1 / E2CAC7ED / E2CB13B1 / E2CB15B1 / E2CB15E1 / E2CB16B1 / E2CB17B1 / E2CB17E1 / E2CBC3B1 / E2CBC3E1 / E2CBC5B1 E2CBC5E1 / E2CBC6B1 / E2CBC6E1 / E2CBC7B1 / E2CBC7E1 / E2KHC2B1 / E2KHC2BD / E2KHC4B1 / E2KHC4BD / E2KHC4E1 / E2KHC5B1 / E2KHC5E1 / E2KHC6B1 / E2KHC7B1 / E2KHC8B1 / E2KHC8BD / E2KHC9B1 / E2KHC9E1 / E2KLC5B1 / E2KLC5E1 / E2KLC7E1 Nabenprofil / Hub Profile: 1 1/2"-10N	(26) (46)
150 E 18 tector 150 E 18 K tector	09.00 - 09.00 -	F4AE0681	 3400 700 430 ■	350 10	E6RA72GA / E6RAC2D1 / E6RAC2DA / E6RAC2G1 / E6RAC2GA / E6RAC4D1 / E6RAC4DA / E6RAC4G1 / E6RAC4GA / E6RAC5D1 / E6RAC5DA / E6RAC5DB / E6RAC5G1 / E6RAC5G2 / E6RAC5GA / E6RAC6D1 / E6RAC6DA / E6RAC6G1 / E6RAC7D1 / E6RAC7DA / E6RAC7G1 / E6RAC7G2 / E6RAC8D1 / E6RAC8DA / E6RAC8G1 / E6RAC9D1 / E6RAC9D2 / E6RAC9DA / E6RAC9G1 / E6RAC9G2 / E6RACBD1 / E6RBC2G1 / E6RBC4G1 / E6RBC4G2 / E6RBC5D1 / E6RBC5DA / E6RBC5G1 / E6RBC6G1 / E6RBC6G2 / E6RBC7D1 / E6RBC7DA / E6RBC7G1 / E6RBC8D1 / E6RBC8G1 / E6RBC9G1 E6RBC9G2 / E6RBCBDA Nabenprofil / Hub Profile: 1 1/2"-10N	(46)
		F4AE0681E	 3400 700 452 ■	350 10	E7REC1D1 / E7REC2D1 / E7REC3D1 / E7REC3DA Nabenprofil / Hub Profile: 1 1/2"-10N	(46)









		CODE				
--	--	------	--	---	---	---

IVECO

EuroCargo		01.91 -					
150 E 18 tector, 150 E 18 P tector, 150 E 18 FP tector 150 E 18 K tector	09.06-	F4AE3481A		3400 700 452 ■	350 10	E7REC1D1 / E7REC2D1 / E7REC3D1 / E7REC3DA Nabenprofil / Hub Profile: 1 1/2"-10N	(46)
	09.06-			3400 700 474 ■	362 10	Getr. / GBox: ZF S5-42 Nabenprofil / Hub Profile: 31,01x38,53-10Z	(46)
				3400 700 475 ■	362 10	Getr. / GBox: ZF 6S 700 T0 Nabenprofil / Hub Profile: 31,02x38,55-10Z	(46)
				3400 700 487 ⊗ 3482 000 419 ⊗ 1878 079 331 ⦿ 3151 000 515	362 10	Getr. / GBox: ZF 6AS 700 T0 MF362 362WGTZ KZIS-4	
150 E 18 K	01.92-	8060		3400 700 449 ■	310 10	Getriebenummer / Transmission Number: 2870.9 E2CA31B1 / E2CA32B1 / E2CAD1B1 / E2CAD2B1 Nabenprofil / Hub Profile: 1 1/2"-10N	(26)
				⊗ 3482 094 031 ⊗ 1878 000 611 ⦿ 3151 600 544	310 10	MFZ310 310TB KZISZ-3	(46)
150 E 23, 150 E 23 P, 150 E 23 FP	01.92-	8060		3400 068 031	330 10	Getriebenummer / Transmission Number: 2865.6 E2DAC7A1 / E2DAC7D1 / E2DCC7AD / E2DAC1A1 / E2DAC2A1 / E2DAC2D1 / E2DAC3A1 / E2DAC3D1 / E2DAC4A1 / E2DAC4D1 / E2DAC5A1 / E2DAC5D1 / E2DAC6A1 / E2DAC6D1 / E2MHC4A1 / E2MHC5A1 / E2MHC7A1 / E2MHC8A1	(26)
				⊗ 3482 093 031 ⊗ 1862 310 132 ⦿ 3151 600 544	330 10	MFZ330 330GSB KZISZ-3	(26)
				3400 068 031	330 10	Getriebenummer / Transmission Number: 2870.9 E2DAC6E1 / E2DAC7B1 / E2DAC7E1 / E2DB13B1 / E2DB13E1 / E2DB15B1 / E2DB15E1 / E2DB16B1 / E2DB16E1 / E2DB17B1 / E2DB17E1 / E2DBC3B1 / E2DBC3E1 / E2DBC5B1 / E2DBC5E1 / E2DBC6B1 / E2DBC6E1 / E2DBC7B1 / E2DBC7E1 / E2DC13B1 / E2DC13E1 / E2DC15B1 / E2DC16B1 / E2DC16E1 / E2DC17B1 / E2DC17E1 / E2DCC3B1 / E2DCC3E1 / E2DCC5B1 / E2DCC5E1 / E2DCC6B1 / E2DCC6E1 / E2DCC7B1 / E2DCC7E1 / E2MHC2B1 / E2DA11B1 / E2DA12B1 / E2DA12E1 / E2DA13B1 / E2DA13E1 / E2DA14B1 / E2DA14E1 / E2DA15B1 / E2DA15E1 / E2DA16B1 E2DA16E1 / E2DA17B1 / E2DA17E1 / E2DAC1B1 / E2DAC2B1 / E2DAC2E1 / E2DAC3B1 / E2DAC3E1 / E2DAC4B1 / E2DAC4E1 / E2DAC5B1 / E2DAC5E1 / E2DAC6B1 / E2MHC5B1 / E2MHC6B1 / E2MHC7B1 / E2MHC8B1 / E2MHC8E1 / E2MHC9B1 / E2MHC9E1 / E2MLC5B1 / E2MLC7B1 / E2MLC7E1 / E2MLC8B1 / E2MLC8E1 / E2MLC9B1 / E2MLC9E1	(26)
				⊗ 3482 094 031 ⊗ 1878 000 611 ⦿ 3151 600 544	310 10	MFZ310 310TB KZISZ-3	(46)
				3400 068 031	330 10	Getriebenummer / Transmission Number: 2870S.9 E2MMC9E1	(26)
				⊗ 3482 093 031 ⊗ 1862 310 132 ⦿ 3151 600 544	330 10	MFZ330 330GSB KZISZ-3	(26)
150 E 24 tector, 150 E 25 tector 150 E 24 K tector	09.00-	F4AE0681		3400 074 031	400 10	E6TA87E1 / E6TAC2G1 / E6TAC2GA / E6TAC4G1 / E6TAC5G1 / E6TAC5G2 / E6TAC6G1 / E6TAC6G2 / E6TAC6GA / E6TAC7G1 / E6TAC7G2 / E6TAC8G1 / E6TAC8G2 / E6TAC9G1 / E6TAC9G2 / E6TAC9GA / E6TACBG1 / E6TACBG2 / E6TACBGA / E6TBC2G1 / E6TBC4G1 / E6TBC5G1 / E6TBC5G2 / E6TBC6G1 / E6TBC6G2 / E6TBC7G1 / E6TBC7G2 / E6TBC8G1 / E6TBC8G2 / E6TBC9G1 / E6TBC9G2 / E6TBCBG1 / E6TBCBG2 / E6TCC5G1 / E6TCC6G1 / E6TCC7G1 / E6TCC7G2 / E6TCC8G1 / E6TCC8G2 / E6TCC9G1 / E6TCC9G2 / E6TCCBG1 / E6TCCBG2	
	09.00-			⊗ 3482 078 134 ⊗ 1862 308 031 ⦿ 3151 000 144	400 10	MFZ400 380GSZ KZISZ-5	
150 E 27, 150 E 27 P, 150 E27FP, 150 E 27 R	01.92-	8360.46		3400 074 031	400 10	Getriebenummer / Transmission Number: 2895.9 E2FA11A1 / E2FA12A1 / E2FA12C1 / E2FA13A1 / E2FA13C1 / E2FA14A1 / E2FA14C1 / E2FA15A1 / E2FA15AD / E2FA15C1 / E2FA16A1 / E2FA16C1 / E2FA17A1 / E2FA17C1 / E2FB13A1 / E2FB13C1 / E2FB15A1 / E2FB15C1 / E2FB16A1 / E2FB16C1 / E2FB17A1 / E2FB17C1 / E2FC13A1 / E2FC13C1 / E2FC15A1 / E2FC15C1 / E2FC16A1 / E2FC16C1 / E2FC17A1 / E2FC17C1	(26)
		8360.46E2			3400 074 031	400 10	Getriebenummer / Transmission Number: 2895.9 E2FH14A1 / E2FH15A1 / E2FH16A1 / E2FH17A1 /

		CODE				
--	--	------	--	---	---	---

IVECO

EuroCargo		01.91 -					
150 E 28 tector	09.00-	F4AE0681	 3400 074 031 ⊗ 3482 078 134 ⊗ 1862 308 031 ⊙ 3151 000 144	400 10 MFZ400 380GSZ KZISZ-5	E6UA87G1 / E6UA87G5 / E6UAC2G1 / E6UAC4G1 / E6UAC5G1 / E6UAC5G2 / E6UAC6G1 / E6UAC6G2 / E6UAC7G1 / E6UAC7G2 / E6UAC8G1 / E6UAC8G2 / E6UAC9G1 / E6UAC9G2 / E6UACBG2 / E6UBC2G1 / E6UBC4G1 / E6UBC5G1 / E6UBC5G2 / E6UBC6G1 / E6UBC6G2 / E6UBC7G1 / E6UBC7G2 / E6UBC8G1 / E6UBC8G2 / E6UBC9G1 / E6UBC9G2 / E6UBCBG1 / E6UBCBG2 / E6UCC5G1 / E6UCC6G1 / E6UCC6G2 / E6UCC7G1 / E6UCC7G2 / E6UCC8G1 / E6UCC8G2 / E6UCC8GB / E6UCC9G1 / E6UCC9G2 / E6UCC9GA / E6UCCBG1 / E6UCCBG2 / E6UCCBGB		
150 E 28 K tector	09.00-	F4AE0681	 3400 074 031 ⊗ 3482 078 134 ⊗ 1862 308 031 ⊙ 3151 000 144	400 10 MFZ400 380GSZ KZISZ-5	E6UA87G1 / E6UA87G5 / E6UAC4G1 / E6UAC5G1 / E6UAC5G2 / E6UAC6G1 / E6UAC6G2 / E6UAC7G1 / E6UAC7G2 / E6UAC8G1 / E6UAC8G2 / E6UAC9G1 / E6UAC9G2 / E6UBC2G1 / E6UBC4G1 / E6UBC5G1 / E6UBC5G2 / E6UBC6G1 / E6UBC6G2 / E6UBC7G1 / E6UBC7G2 / E6UBC8G1 / E6UBC8G2 / E6UBC9G1 / E6UBC9G2 / E6UBCBG1 / E6UBCBG2 / E6UCC5G1 / E6UCC6G1 / E6UCC6G2 / E6UCC7G1 / E6UCC7G2 / E6UCC8G1 / E6UCC8G2 / E6UCC8GB / E6UCC9G1 / E6UCC9G2 / E6UCC9GA / E6UCCBG1 / E6UCCBG2		
170 E 18, 180 E 18	01.94-	8060	 3400 700 449 ■ ⊗ 3482 094 031 ⊗ 1878 000 611 ⊙ 3151 600 544	310 10 MFZ310 310TB KZISZ-3	Getriebenummer / Transmission Number: 2870.9 F0AAC4E1 / F0AAC5B1 / F0AAC5BD / F0AAC5ED / F0AAC6B1 / F0AAC6BD / F0AAC6ED / F0AAC7B1 / F0AAC7BD / F0AAC7E1 / F0AAC7ED / F0AAC8BD / F0AAC8ED / F0AAC9BD / F0AAC9ED / F0ABC4BD / F0ABC4ED / F0ABC7BD / F0ABC7ED / F0ABC8BD / F0ABC8ED / F0ABC9BD / F0KHC2B1 / F0KHC2BD / F0KHC3B1 / F0KHC3BD / F0KHC4B1 / F0KHC8BD / F0AAC2B1 / F0AAC3B1 / F0AAC3BD / F0AAC3E1 / F0AAC3ED / F0AAC4B1 / F0AAC4BD Nabenprofil / Hub Profile: 1 1/2"-10N	(26)	
			 3400 700 449 ■ ⊗ 3482 094 031 ⊗ 1878 000 611 ⊙ 3151 600 544	310 10 MFZ310 310TB KZISZ-3	Getriebenummer / Transmission Number: 2865.6 F0AAC4D1 / F0AAC4DD / F0AAC5A1 / F0AAC5AD / F0AAC5D1 / F0AAC6A1 / F0AAC6AD / F0AAC6D1 / F0AAC7A1 / F0AAC7AD / F0AAC7DD / F0AAC8AD / F0AAC8DD / F0AAC9AD / F0AAC9DD / F0ABC5DD / F0ABC7AD / F0ABC8AD / F0ABC9DD / F0KHC2A1 / F0KHC2AD / F0KHC3AD / F0KHC6AD / F0KHC7AD / F0KHC8AD / F0KHC9AD / F0KLC4A1 / F0KLC7AD / F0AAC2A1 / F0AAC2AD / F0AAC3AD / F0AAC3DD / F0AAC4AD Nabenprofil / Hub Profile: 1 1/2"-10N	(46)	
170 E 18 K, 180 E 18 K	01.94-	8060	 3400 700 449 ■ ⊗ 3482 094 031 ⊗ 1878 000 611 ⊙ 3151 600 544	310 10 MFZ310 310TB KZISZ-3	Getriebenummer / Transmission Number: 2870.9 F0AAD2B1 / F0AAD2BD / F0AAD3B1 / F0AAD3BD Nabenprofil / Hub Profile: 1 1/2"-10N	(26)	
			 3400 700 449 ■ ⊗ 3482 094 031 ⊗ 1878 000 611 ⊙ 3151 600 544	310 10 MFZ310 310TB KZISZ-3	Getriebenummer / Transmission Number: 2865.6 F0AAD2A1 / F0AAD2AD / F0AAD3A1 / F0AAD3AD Nabenprofil / Hub Profile: 1 1/2"-10N	(46)	
170 E 23, 180 E 23	01.94-	8060	 3400 068 031 ⊗ 3482 093 031 ⊗ 1862 310 132 ⊙ 3151 600 544	330 10 MFZ330 330GSB KZISZ-3	->Chass. 2253628 Getriebenummer / Transmission Number: 2870.9 F0BA12B1 / F0BA13B1 / F0BA13ED / F0BA14B1 / F0BA15B1 / F0BA15BD / F0BA15E1 / F0BA16B1 / F0BA16E1 / F0BA17B1 / F0BA17BD / F0BA17E1 / F0BA17ED / F0BAC2B1 / F0BAC2BD / F0BAC3B1 / F0BAC3BD / F0BAC3E1 / F0BAC4B1 / F0BAC4BD / F0BAC4E1 / F0BAC4ED / F0BAC5B1 / F0BAC5BD / F0BAC5E1 / F0BAC5ED / F0BAC6B1 / F0BAC6BD / F0BAC6E1 / F0BAC6ED / F0BAC7B1 / F0BAC7BD / F0BAC7E1 / F0BAC7ED / F0BAC8BD / F0BAC8ED / F0BAC9BD / F0BAC9ED / F0BB17BD / F0BB17ED / F0BBC4BD / F0BBC5BD / F0BBC6BD / F0BBC6ED / F0BBC7BD F0BBC7ED / F0BBC8BD / F0BBC8ED / F0BBC9BD / F0BBC9ED	(26)	
			 3400 068 031 ⊗ 3482 093 031 ⊗ 1862 310 132 ⊙ 3151 600 544	330 10 MFZ330 330GSB KZISZ-3	->Chass. 2253628 Getriebenummer / Transmission Number: 2865.6 F0BAC2A1 / F0BAC3A1 / F0BAC4A1 / F0BAC5A1 / F0BAC7A1 / F0BAC7D1 / F0BAC9DD	(26)	





























IVECO

EuroCargo		01.91 -					
170 E 23 K, 180 E 23 K	01.94 -	8060		3400 068 031 ● 3482 093 031 ● 1862 310 132 ● 3151 600 544	330 10 MFZ330 330GSB KZISZ-3	->Chass. 2253628 Getriebenummer / Transmission Number: 2870.9 F0BAD2B1 / F0BAD2BD / F0BAD3B1 / F0BAD3BD	(26)
				3400 068 031 ● 3482 093 031 ● 1862 310 132 ● 3151 600 544	330 10 MFZ330 330GSB KZISZ-3		
170 E 27, 180 E 27	01.94 -	8360.46E2		3400 074 031 ● 3482 078 134 ● 1862 308 031 ● 3151 000 144	400 10 MFZ400 380GSZ KZISZ-5	Getriebenummer / Transmission Number: 2895.9 F0FHC2A1 / F0FHC3A1 / F0FHC3D1 / F0FHC4A1 / F0FHC5A1 / F0FHC6A1 / F0FHC7A1 / F0FHC7D1 / F0FHC8A1 / F0FHC8D1 / F0FHC9D1 / F0FLC4A1 / F0FLC4D1 / F0FLC5A1 / F0FLC5D1 / F0FLC6A1 / F0FLC6D1 / F0FLC7A1 / F0FLC7D1 / F0FLC8AD / F0FLC8D1 / F0FLC9AD / F0FLC9D1	(26)
180 E 21 tector 180 E 21 K tector	09.00 - 09.00 -	F4AE0681		3400 700 430	350 10	F0SAC4DA / F0SAC4G1 / F0SAC5D1 / F0SAC5D2 / F0SAC5DA / F0SAC5G1 / F0SAC6DA / F0SAC6G1 / F0SAC7DA / F0SAC7G1 / F0SAC8D1 / F0SAC8DA / F0SAC8G1 / F0SAC9D1 / F0SAC9DA / F0SAC9G1 / F0SAC9G2 / F0SACAD1 / F0SACADA / F0SACAG1 / F0SACBDA / F0SACBDB / F0SACBGA / F0SBC6G1 / F0SBC7G1 / F0SBC9DA / F0SBC9DB / F0SBC9GA / F0SBCAGA / F0SBCBDB Nabenprofil / Hub Profile: 1 1/2"-10N	(46)
180 E 21 T	01.91 -	8060		3400 068 031 ● 3482 093 031 ● 1862 310 132 ● 3151 600 544	330 10 MFZ330 330GSB KZISZ-3	Getriebenummer / Transmission Number: 2865.6 D3LA22A1 / D3LA22AD / D3LA22C1 / D3LA22CD / D3LB22A1 / D3LB22C1	(26)
180 E 24, 180 E 25 tector	09.00 -	F4AE0681		3400 700 430	350 10	F0SBCBDB Nabenprofil / Hub Profile: 1 1/2"-10N	(46)
				3400 074 031 ● 3482 078 134 ● 1862 308 031 ● 3151 000 144	400 10 MFZ400 380GSZ KZISZ-5		
180 E 24 K tector	09.00 -	F4AE0681		3400 074 031 ● 3482 078 134 ● 1862 308 031 ● 3151 000 144	400 10 MFZ400 380GSZ KZISZ-5	F0TAC4G1 / F0TAC4GA / F0TAC5G1 / F0TAC5GA / F0TAC5GB / F0TAC6G1 / F0TAC6G2 / F0TAC6GA / F0TAC7G1 / F0TAC7GA / F0TAC8G1 / F0TAC8GA / F0TAC9G1 / F0TAC9G2 / F0TAC9GA / F0TAC9GB / F0TACAG1 / F0TACAG2 / F0TACAGA / F0TACAGB / F0TACBG1 / F0TACBG2 / F0TACBGA / F0TACBGB / F0TBC4G1 / F0TBC5G1 / F0TBC6G1 / F0TBC7G1 / F0TBC7GA / F0TBC8G1 / F0TBC8G2 / F0TBC8GB / F0TBC9G1 / F0TBC9G2 / F0TBC9GA / F0TBCAG1 / F0TBCAG2 / F0TBCAGA / F0TBCAGB / F0TBCBG1 / F0TBCBG2 / F0TBCBGB	
180 E 28 tector, 180 E 28 P tector	09.00 -	F4AE0681		3400 074 031 ● 3482 078 134 ● 1862 308 031 ● 3151 000 144	400 10 MFZ400 380GSZ KZISZ-5	F0UAC4G1 / F0UAC4GA / F0UAC5G1 / F0UAC5G2 / F0UAC6G1 / F0UAC6G2 / F0UAC7G1 / F0UAC7G2 / F0UAC8G1 / F0UAC8G2 / F0UAC8GA / F0UAC9G1 / F0UAC9G2 / F0UAC9GA / F0UACAG1 / F0UACAG2 / F0UACAGA / F0UACAGB / F0UACBG1 / F0UACBG2 / F0UACBGA / F0UACBGB / F0UBC4G1 / F0UBC5G1 / F0UBC6G1 / F0UBC6G2 / F0UBC7G1 / F0UBC7G2 / F0UBC8G1 / F0UBC8G2 / F0UBC9G1 / F0UBC9G2 / F0UBC9GA / F0UBC9GB / F0UBCAG1 / F0UBCAG2 / F0UBCBG1 / F0UBCBG2 / F0UBCBGA / F0UBCBGB	
180 E 28 K tector	09.00 -	F4AE0681		3400 074 031 ● 3482 078 134 ● 1862 308 031 ● 3151 000 144	400 10 MFZ400 380GSZ KZISZ-5	F0UAC4G1 / F0UAC4GA / F0UAC5G1 / F0UAC5G2 / F0UAC6G1 / F0UAC6G2 / F0UAC7G1 / F0UAC7G2 / F0UAC8G1 / F0UAC8G2 / F0UAC8GA / F0UAC9G1 / F0UAC9G2 / F0UAC9GA / F0UACAG1 / F0UACAG2 / F0UACAGA / F0UACAGB / F0UACBG1 / F0UACBG2 / F0UACBGA / F0UACBGB / F0UBC4G1 / F0UBC5G1 / F0UBC5GA / F0UBC6G1 / F0UBC6G2 / F0UBC7G1 / F0UBC7G2 / F0UBC8G1 / F0UBC8G2 / F0UBC9G1 / F0UBC9G2 / F0UBC9GA / F0UBC9GB / F0UBCAG1 / F0UBCAG2 / F0UBCBG1 / F0UBCBG2 / F0UBCBGA / F0UBCBGB	
260 E 23 T	01.92 -	8060		3400 068 031	330 10	Getriebenummer / Transmission Number: 2870.9 E0DA21B1 / E0DA21BD / E0DA21E1 / E0DA21ED /	(26)















		CODE				
--	--	------	--	---	---	---

IVECO

EuroCargo		01.91 -					
280 E 23 T	01.92 -	8060	 3400 068 031 ⊗ 3482 093 031 ⊗ 1862 310 132 ⊙ 3151 600 544	330 10 MFZ330 330GSB KZISZ-3	Getriebenummer / Transmission Number: 2870.9 E2DA21B1 / E2DA21BD / E2DA22BD / E2DA22E1 / E2DA22ED / E2DB21B1 / E2DB22E1	(26)	
320 E 27 T	01.92 -	8360.46	 3400 074 031 ⊗ 3482 078 134 ⊗ 1862 308 031 ⊙ 3151 000 144	400 10 MFZ400 380GSZ KZISZ-5	Getriebenummer / Transmission Number: 2895.9 E2FA21A1 / E2FA21AD / E2FA22A1 / E2FA22AD / E2FA22C1 / E2FA22CD / E2FB21A1 / E2FB22A1 / E2FB22C1	(26)	
		8360.46E2	 3400 074 031 ⊗ 3482 078 134 ⊗ 1862 308 031 ⊙ 3151 000 144	400 10 MFZ400 380GSZ KZISZ-5	Getriebenummer / Transmission Number: 2895.9 E2FH23A1 / E2FH23D1 / E2FL22A1 / E2FL23A1 / E2FL23D1	(26)	
320 E 28 T tector	09.00 -	F4AE0681	 3400 074 031 ⊗ 3482 078 134 ⊗ 1862 308 031 ⊙ 3151 000 144	400 10 MFZ400 380GSZ KZISZ-5	E6UA2YG1 / E6UB22G1 / E6UB22GA / E6UB2YG1 / E6UB2YG2 / E6UB2YGA		

EuroFire							
60 .9 A			 3151 199 001	KZIS-3			
65 .12 A			 3482 008 033	310 MF310			
			 1861 577 037 #	310 10 310GTD			
			 3151 199 001	KZIS-3			
75 .14 A-AW 75 .16 A-AW 90 .16 A-AW			 3482 038 031	350 GMF350			
			 1861 742 032	350 10 350GTB			
			 3151 199 001	KZIS-3			
75 E 14	05.91 -		 3400 066 031 ⊗ 3482 092 031 ⊗ 1878 074 841 ⊙ 3151 600 544	280 10 MFZ280 280GTZ KZISZ-3	->Chass. 2180116		
75 E 14			 3482 094 031 #	310 MFZ310	Chass. 2180117->		
			 1878 000 611	310 10 310TB			
			 3151 600 544	KZISZ-3	Chass. 2180117->		
95 E 18	05.91 -		 3400 700 449 ■ ⊗ 3482 094 031 ⊗ 1878 000 611 ⊙ 3151 600 544	310 10 MFZ310 310TB KZISZ-3	Nabenprofil / Hub Profile: 1 1/2"-10N	(46)	
120 .19 A-AW 140 .19 A			 3482 002 234	350 GMF350X			
			 1878 001 070	350 10 350GTZ			
			 3151 000 515	KZIS-4			
120 .23 AW 120 .25 AW,AN 140 .25 A			 1882 325 139	380 G380			
			 1878 000 957	380 10 380GTZ			
			 3151 000 515	KZIS-4			
130 E 24 135 E 22	05.91 - 05.91 -		 3400 068 031 ⊗ 3482 093 031 ⊗ 1862 310 132 ⊙ 3151 600 544	330 10 MFZ330 330GSB KZISZ-3			
150 E 27	12.91 -		 3400 074 031 ⊗ 3482 078 134 ⊗ 1862 308 031 ⊙ 3151 000 144	400 10 MFZ400 380GSZ KZISZ-5			
160 .30 AH-AHW			 3482 124 516	430 GMF430			
			 1878 002 955	420 10 420GTZ			
			 3151 000 515	KZIS-4			











IVECO

EuroStar		01.93 - 02.02					
LD 190 E 38 P	01.93-02.02	8460	 3400 077 071 ⊗ 3482 078 134 ⊗ 1862 317 032 ⊙ 3151 000 144	400 10 MFZ400 400GVZ KZISZ-5	Getr. / GBox: Fuller		
LD 240 E 38	01.93-02.02						
LD 260 E 38 P	01.93-02.02						
LD 400 E 38 TX/P, LD 440 E 38 TX/P	01.93-02.02			 3400 084 031 ⊗ 3482 078 134 ⊗ 1878 032 032 ⊙ 3151 000 144	400 10 MFZ400 400WGTZ KZISZ-5	Getr. / GBox: ZF	
LD 440 E 38 T	01.93-02.02						
LD 440 E 38 TZ	01.93-02.02						
LD 190 E 39 P, LD 190 E 39 FP	11.99-02.02	F3AE0681	 3400 117 801 ⊗ 3482 083 032 ⊗ 1878 085 741 ⊙ 3151 000 144	430 10 MFZ430 430WGTZ KZISZ-5	L1JB15H2 / L1JB15N2 / L1JB17E2 / L1JB17H2 / L1JB17N2 / L1JB18H2 / L1JB18N2 / L1JB19F2 / L1JB19N2 / L1JC17F2 / L1JC18E2 / L1JC18F2 / L1JC18H2 / L1JC18N2 / L1JCL7N2 / L1JCL8H2 / L1JCL9H2 / L1JCL9N2		
LD 190 E 40	09.00-02.02	F3AE0681B	 3400 117 801 ⊗ 3482 083 032 ⊗ 1878 085 741 ⊙ 3151 000 144	430 10 MFZ430 430WGTZ KZISZ-5	Getr. / GBox: ZF		
LD 260 E 40	09.00-02.02						
LD 440 E 40 T	09.00-02.02						
LD 440 E 40 TX/P	01.01-02.02						
LD 190 E 42, LD 190 E 42 P	01.93-02.02	8210	 3400 700 455 ■	430 10	Getr. / GBox: Fuller Nabenprofil / Hub Profile: 41,1x50,8-10N	(46)	
LD 190 E 47	01.93-02.02			 3400 117 801 ⊗ 3482 083 032 ⊗ 1878 085 741 ⊙ 3151 000 144	430 10 MFZ430 430WGTZ KZISZ-5	Getr. / GBox: ZF	
LD 240 E 42 FS, LD 240 E 42 PS	01.93-02.02						
LD 240 E 47 PS	01.93-02.02						
LD 260 E 42 P	01.93-02.02						
LD 260 E 47	01.93-02.02						
LD 400 E 42 TX/P, LD 440 E 42 TX/P	01.93-02.02						
LD 440 E 42 T/P	01.93-02.02						
LD 440 E 42 TZ	01.93-02.02						
LD 440 E 47 T/P	01.93-02.02						
LD 440 E 47 TZ	01.93-02.02						
LD 190 E 43, LD 190 E 43 P, LD 190 E 43 FP	11.99-02.02	F3AE0681	 3400 117 801 ⊗ 3482 083 032 ⊗ 1878 085 741 ⊙ 3151 000 144	430 10 MFZ430 430WGTZ KZISZ-5	L1KB15C2 / L1KB17A2 / L1KB17C2 / L1KB17D2 / L1KB18A2 / L1KB18C2 / L1KB18D2 / L1KB19C2 / L1KB19D2 / L1KC18A2 / L1KC18D2 / L1KCL7D2 / L1KCL8A2 / L1KCL8D2 / L1KCL9D2		
LD 190 E 52	01.93-02.02	8280.42S.TCA	 3400 700 455 ■	430 10	Getr. / GBox: Fuller Nabenprofil / Hub Profile: 41,1x50,8-10N	(46)	
LD 240 E 52 PS	01.93-02.02			 3400 117 801 ⊗ 3482 083 032 ⊗ 1878 085 741 ⊙ 3151 000 144	430 10 MFZ430 430WGTZ KZISZ-5	Getr. / GBox: ZF	
LD 260 E 52	01.93-02.02						
LD 440 E 52 T	01.93-02.02						
LD 440 E 52 TZ	01.93-02.02						
LD 260 E 39 P, LD 260 E 39 FP	11.99-02.02	F3AE0681	 3400 117 801 ⊗ 3482 083 032 ⊗ 1878 085 741 ⊙ 3151 000 144	430 10 MFZ430 430WGTZ KZISZ-5	L3JB15H2 / L3JB15N2 / L3JB16E2 / L3JB16H2 / L3JB16N2 / L3JB17HD / L3JB17ND / L3JB18N2 / L3JE14E2 / L3JE14F2 / L3JE14H2 / L3JE14N2 / L3JE15E2 / L3JE15F2 / L3JE15H2 / L3JE15N2 / L3JE16F2 / L3JE17F2 / L3JE17H2 / L3JE17N2 / L3JE18N2 / L3JE19E2 / L3JE19H2 / L3JE19N2 / L3JF15F2 / L7JB15N2		
LD 260 E 43 Y/PS, LD 260 E 43 FP	01.93-02.02	F3AE0681	 3400 117 801 ⊗ 3482 083 032 ⊗ 1878 085 741 ⊙ 3151 000 144	430 10 MFZ430 430WGTZ KZISZ-5	L3KB15D2 / L3KB16A2 / L3KB16C2 / L3KB16D2 / L3KB17C2 / L3KB17D2 / L3KC15C2 / L3KC15D2 / L3KC16A2 / L3KC16C2 / L3KC16D2 / L3KCL6A2 / L3KCL6C2 / L3KCL6D2 / L3KCL7C2 / L3KCL7D2 / L3KE14C2 / L3KE14D2 / L3KE15A2 / L3KE15C2 / L3KE15D2 / L3KE16C2 / L3KE16D2 / L3KE17A2 / L3KE17C2 / L3KE17D2 / L3KE18D2 / L3KE19A2 / L3KE19D2 / L3KF15A2 / L3KF15C2 / L3KF15D2 / L3KF16A2 / L3KF16C2 / L3KF16D2 / L3KF17D2 / L3KFL6C2 / L3KFL6D2 / L3KFL7C2 / L3KFL7D2 / L7KB17D2 / L7KB18D2		
LD 440 E 39 T, LD 440 E 39 T/P	11.99-02.02	F3AE0681	 3400 117 801 ⊗ 3482 083 032 ⊗ 1878 085 741 ⊙ 3151 000 144	430 10 MFZ430 430WGTZ KZISZ-5	L1JB21C2 / L1JB21F2 / L1JB23C2 / L1JB23F2 / L1JB23FD / L2JB21FD		
LD 440 E 43 T/P	01.93-02.02	F3AE0681	 3400 117 801 ⊗ 3482 083 032 ⊗ 1878 085 741 ⊙ 3151 000 144	430 10 MFZ430 430WGTZ KZISZ-5	L1KB21C2 / L1KB23C2 / L1KCT1C2		
LD 440 E 43 TX/P	11.99-02.02	F3AE0681	 3400 117 801 ⊗ 3482 083 032 ⊗ 1878 085 741 ⊙ 3151 000 144	430 10 MFZ430 430WGTZ KZISZ-5	L1KB21C2 / L1KB21DD / L1KB21J2 / L1KB21L2 / L1KB23C2 / L1KB23CD / L1KB23J2 / L1KB23L2 / L1KB23LD / L1KBH3C2 / L1KBH3L2 / L1KCT1C2 / L1KCT1CD / L1KCT1J2 / L1KCT1L2 / L1KCT1LD / L2KB21C2 / L2KB21CD / L2KB21L2 / L2KB21LD		









		CODE				
--	--	------	--	---	---	---

IVECO

EuroStar		01.93 - 02.02			
LD 440 E 48 T/P	01.01 - 02.02	F3AE0681	 3400 117 801 3482 083 032 1878 085 741 3151 000 144	430 10 MFZ430 430WGTZ KZISZ-5	L1PB2112 / L1PB2142 / L1PB21G2 / L1PB21J2 / L1PB21L2 / L1PB21W2 / L1PB23G2 / L1PB23GD / L1PB23J2 / L1PB23L2 / L1PB23W2 / L1PBH3G2



EuroTech MH		09.98 -				
190 E 24, 190 E 24 /P	09.98 -	F2BE0681	 3400 107 031 3482 078 134 1862 317 031 3151 000 144	400 10 MFZ400 400GVZ KZISZ-5	Getriebeummer / Transmission Number: 2895.9 M1NA13A1 / M1NA14A1 / M1NA15A1 / M1NA16A1 / M1NA17A1 / M1NA18A1 / M1NA19A1 / M1NB15A1 / M1NB15A2 / M1NB17A1 / M1NB18A1 / M1NB18A2 / M1NB19A1 / M1NB19A2 / M1NB19AC	(26)
			3400 074 031 3482 078 134 1862 308 031 3151 000 144	400 10 MFZ400 380GSZ KZISZ-5	Getriebeummer / Transmission Number: 2895.9 M1NB19A1	(26)
190 E 24 K 190 E 27 K 190 E 31 K 260 E 27 Y/P, 260 E 27 Y/PS, 260 E 27 RY/PS, 260 E 27 RY/PT	09.98 - 09.98 - 09.98 - 11.99 -	F2BE0681F, F2BE0681D, F2BE0681B, F2BE0681C	 3400 107 031 3482 078 134 1862 317 031 3151 000 144	400 10 MFZ400 400GVZ KZISZ-5	Getr. / GBox: AS Tronic	
190 E 27, 190 E 27 /P	09.98 -	F2BE0681F, F2BE0681C	 3400 074 031 3482 078 134 1862 308 031 3151 000 144	400 10 MFZ400 380GSZ KZISZ-5		
190 E 31, 190 E 31 /P	09.98 -	F2BE0681	 3400 107 031 3482 078 134 1862 317 031 3151 000 144	400 10 MFZ400 400GVZ KZISZ-5	Getr. / GBox: 16S 109 M1PA13B1 / M1PA14B1 / M1PA15B1 / M1PA16B1 / M1PB16B1 / M1PB17B1 / M1PB17B2 / M1PB18B1 / M1PB18B2 / M1PB19B1 / M1PB19B2	
			3400 084 031 3482 078 134 1878 032 032 3151 000 144	400 10 MFZ400 400WGTZ KZISZ-5	Getr. / GBox: AS-tronic M1PA15B1 / M1PB16B1 / M1PB17B1 / M1PB17B2 / M1PB18B1 / M1PB18B2 / M1PB19B2	
190 E 35, 190 E 35 /P, 190 E 35 /FP	09.98 -	F2BE0681	 3400 084 031 3482 078 134 1878 032 032 3151 000 144	400 10 MFZ400 400WGTZ KZISZ-5	Getr. / GBox: 16S 151 M1RA13B1 / M1RB17B2 / M1RB18B1 / M1RB18B2 / M1RB19B2	
260 E 24 Y/P, 260 E 24 Y/PS, 260 E 24 Y/PT	11.99 -	F2BE0681	 3400 107 031 3482 078 134 1862 317 031 3151 000 144	400 10 MFZ400 400GVZ KZISZ-5	Getriebeummer / Transmission Number: 2895.9 M3NE13A1 / M7NA15A1	(26)
260 E 31 Y/P, 260 E 31 Y/PS, 260 E 31 Y/PT	11.99 -	F2BE0681	 3400 107 031 3482 078 134 1862 317 031 3151 000 144	400 10 MFZ400 400GVZ KZISZ-5	Getr. / GBox: 16S 109 M3PB15B1 / M3PE13B1 / M3PE14B1 / M3PE14B2 / M3PE15B1 / M3PE15B2 / M3PE16B1 / M3PE16B2 / M3PE17B1 / M3PE17B2 / M7PA15B1 / M7PA15B2 / M7PA18B2 / M7PB15B1 / M7PB16B1	
			3400 084 031 3482 078 134 1878 032 032 3151 000 144	400 10 MFZ400 400WGTZ KZISZ-5	Getr. / GBox: AS-tronic M3PE13B1 / M3PE14B1 / M3PE15B1 / M3PE17B1	
260 E 35 Y/P, 260 E 35 Y/PT, 260 E 35 Y/TN	11.99 -	F2BE0681	 3400 084 031 3482 078 134 1878 032 032 3151 000 144	400 10 MFZ400 400WGTZ KZISZ-5	Getr. / GBox: 16S 151 M3RE14B1 / M3RE14B2 / M3RE15B1 / M3RE15B2 / M3RE16B2 / M3RE17B2 / M7RB15B2 / M7RB17B1 / M7RB17B2	
400 E 31 TP, 440 E 31 T, 440 E 31 TP	09.98 -	F2BE0681	 3400 107 031 3482 078 134 1862 317 031 3151 000 144	400 10 MFZ400 400GVZ KZISZ-5	Getr. / GBox: 16S 109 M1PB21B1 / M1PB21B2 / M1PB21BC / M1PB23B2	
			3400 084 031 3482 078 134 1878 032 032 3151 000 144	400 10 MFZ400 400WGTZ KZISZ-5	Getr. / GBox: AS-tronic M1PB21B1	
400 E 35 TP, 440 E 35 T, 440 E 35 T/P, 440 E 35 T/FP	09.98 -	F2BE0681	 3400 084 031 3482 078 134 1878 032 032 3151 000 144	400 10 MFZ400 400WGTZ KZISZ-5	Getr. / GBox: 16S 151 M1RA21B1 / M1RA21B2 / M1RB21B1 / M1RB21B2 / M1RB23B2 / M1RB23BD	
			3400 084 031 3482 078 134 1878 032 032 3151 000 144	400 10 MFZ400 400WGTZ KZISZ-5	Getr. / GBox: 12AS 1800 DD M1RB21C2	





IVECO





EuroTech MP		01.92 -					
180 E 34	01.92 - 12.93	8460		3400 084 031 ⊗ 3482 078 134 ⊗ 1878 032 032 ⊙ 3151 000 144	400 10 MFZ400 400WGTZ KZISZ-5	Getr. / GBox: ZF	
180 E 38	01.92 - 12.93						
190 E 34	01.93-						
190 E 38	01.93-			3400 077 071 ⊗ 3482 078 134 ⊗ 1862 317 032 ⊙ 3151 000 144	400 10 MFZ400 400GVZ KZISZ-5	Getr. / GBox: Fuller	
240 E 34	09.95 - 12.96						
240 E 38	01.92-						
260 E 38 P	01.94-						
400 E 34 T, 440 E 34 T	01.92-						
400 E 38 T, 440 E 38 T, 440 E 38 T /P	01.92-						
400 E 38 TXP	11.93 - 12.96						
440 E 38 TZ	01.93-						
180 E 42	01.92 - 12.93	8210		3400 700 455 ■	430 10	Getr. / GBox: Fuller	
190 E 42, 190 E 42 /P	01.93-					Nabenprofil / Hub Profile: 41,1x50,8-10N	(46)
240 E 42	01.92-			3400 117 801 ⊗ 3482 083 032 ⊗ 1878 085 741 ⊙ 3151 000 144	430 10 MFZ430 430WGTZ KZISZ-5	Getr. / GBox: ZF	
260 E 42	01.94-						
400 E 42 T, 440 E 42 T, 440 E 42 T/P	01.92-						
440 E 42 TZ	01.93-						
190 E 39, 190 E 39 /P, 190 E39 /FP	11.99-	F3AE0681		3400 117 801 ⊗ 3482 083 032 ⊗ 1878 085 741 ⊙ 3151 000 144	430 10 MFZ430 430WGTZ KZISZ-5	M1JB15C1 / M1JB15D1 / M1JB15E1 / M1JB15F2 / M1JB15H1 / M1JB15H2 / M1JB15N1 / M1JB17C2 / M1JB17D1 / M1JB17E1 / M1JB17F1 / M1JB17F2 / M1JB17H1 / M1JB17H2 / M1JB17N1 / M1JB17N2 / M1JB18A1 / M1JB18C2 / M1JB18F2 / M1JB18H2 / M1JB18N2 / M1JB19C2 / M1JB19H2 / M1JB19N2 / M1JCL8C2 / M1JCL8D2 / M1JCL8F2 / M1JCL8FD / M1JCL9D2 / M1JCLL2 / M1JCLLF2 / M1JCN8A2 / M1JCN8D2 / M1JCN8E2 / M1JCN8H2 / M1JCN8HD / M1JCN8N2 / M1JCN8ND / M1JCNLA2 / M1JCNLD2 / M1JCNLE2 / M1JCNLH2 / M1JCNLN2 / M1JCNLND	
190 E 43, 190 E 43 /P	01.01 -	F3AE0681		3400 117 801 ⊗ 3482 083 032 ⊗ 1878 085 741 ⊙ 3151 000 144	430 10 MFZ430 430WGTZ KZISZ-5	M1KA14D1 / M1KA17D2 / M1KB15A1 / M1KB15D1 / M1KB15D2 / M1KB17A1 / M1KB17A2 / M1KB17D1 / M1KB17D2 / M1KB18A1 / M1KB18A2 / M1KB18D1 / M1KB18D2 / M1KB19D2 / M1KC17D1 / M1KC18D1 / M1KC18D2 / M1KCL8D2 / M1KCN8D2 / M1KCNLA2 / M1KCNLD2	
240 E 30 PS	01.97 -	8460		3400 084 031 ⊗ 3482 078 134 ⊗ 1878 032 032 ⊙ 3151 000 144	400 10 MFZ400 400WGTZ KZISZ-5		
260 E 39 Y, 260 E 39 Y/P, 260 E 39 Y/FP, 260 E 39 Y/FS	11.99-	F3AE0681		3400 117 801 ⊗ 3482 083 032 ⊗ 1878 085 741 ⊙ 3151 000 144	430 10 MFZ430 430WGTZ KZISZ-5	M3JB14E2 / M3JB14N1 / M3JB15H1 / M3JB15H2 / M3JB16A1 / M3JB16D1 / M3JB16D2 / M3JB16E2 / M3JB16N2 / M3JB17C2 / M3JB17F2 / M3JC14H1 / M3JC15F1 / M3JC15F2 / M3JC15H1 / M3JC16F2 / M3JC16N2 / M3JC17N2 / M3JE14A1 / M3JE14C1 / M3JE14C2 / M3JE14E1 / M3JE14E2 / M3JE14F1 / M3JE14F2 / M3JE14H1 / M3JE14H2 / M3JE14N1 / M3JE14N2 / M3JE15C1 / M3JE15C2 / M3JE15D2 / M3JE15F1 / M3JE15F2 / M3JE15H1 / M3JE15H2 / M3JE15N1 / M3JE15N2 / M3JE16A1 / M3JE16C1 / M3JE16C2 / M3JE16E2 / M3JE16F1 / M3JE16F2 / M3JE16H1 / M3JE16H2 / M3JE16N1 / M3JE16N2 / M3JE17C2 / M3JE17F2 / M3JE17H2 / M3JE18D2 / M3JE18N2 / M3JE19D2 / M3JE19H2 / M3JE19N2 / M3JF14A1 / M3JF14E1 / M3JF15E1 / M3JF15H1 / M3JF15H2 / M3JF15N1 / M3JF15N2 / M3JF16D2 / M3JF16E2 / M3JF16F2 / M3JF16H2 / M3JF16N2 / M3JF17E2 / M3JF17H2 / M3JFL6N1 / M7JB15N2	
260 E 43 Y, 260 E 43 Y/P	11.99-	F3AE0681		3400 117 801 ⊗ 3482 083 032 ⊗ 1878 085 741 ⊙ 3151 000 144	430 10 MFZ430 430WGTZ KZISZ-5	M7KB15D1 / M7KB16D1 / M7KB16D2 / M7KB17D1 / M7KB17D2 / M7KB17DD / M7KB18D2 / M3KB14D1 / M3KB15D1 / M3KB15D2 / M3KB16D1 / M3KB16D2 / M3KB17D2 / M3KB18D2 / M3KC15D2 / M3KC16D2 / M3KC17D2 / M3KCL6D1 / M3KE14A1 / M3KE14C1 / M3KE14C2 / M3KE14D1 / M3KE14D2 / M3KE15A1 / M3KE15A2 / M3KE15C1 / M3KE15C2 / M3KE15D1 / M3KE15D2 / M3KE16A2 / M3KE16C1 / M3KE16C2 / M3KE16D1 / M3KE16D2 / M3KE17C2 / M3KE17D2 / M3KE18D2 / M3KE19D2 / M3KF14A1 / M3KF14D1 / M3KF15D1 / M3KF15D2 / M3KF16D2 / M3KF17D2 / M3KFL6D2 / M3KFL7D1 / M3KFL7D2 / M3KFL8D1 / M7KA15D1 / M7KA15D2 / M7KA16D1	

		CODE				
--	--	------	--	---	---	---

IVECO









EuroTech MP		01.92 -				
440 E 39 T, 440 E 39 T/P, 440 E 39 T/FP-CT 440 E 39 TX/P	11.99- 11.99-	F3AE0681		3400 117 801 ⊗ 3482 083 032 ⊗ 1878 085 741 ⬤ 3151 000 144	430 10 MFZ430 430WGTZ KZISZ-5	M1JB21C1 / M1JB21C2 / M1JB21F1 / M1JB21F2 / M1JB21G1 / M1JB21G2 / M1JB21M1 / M1JB21N2 / M1JB21P1 / M1JB21P2 / M1JB21PC / M1JB23C1 / M1JB23C2 / M1JB23CD / M1JB23F1 / M1JB23F2 / M1JB23FD / M1JB23G1 / M1JB23G2 / M1JB23GD / M1JB23HD / M1JB23M1 / M1JB23M2 / M1JB23P1 / M1JB23P2 / M1JB23PD / M1JBH1DD / M1JBH3H2 / M1JBH3HD / M1JCM3A2 / M1JCM3D2 / M1JCM3E2 / M1JCM3H2 / M1JCM3HD / M1JCM3N2 / M1JCM3ND / M1JCT3C2 / M1JCT3F2 / M1JCT3FD / M1JD23D2 / M1JE2112 / M2JB21FD / M2JB21G1 / M2JB21G2 / M2JB21GD M2JB21L2 / M2JB21P2 / M2JB21PD
440 E 43 T, 440 E 43 T/P	11.99-	F3AE0681		3400 117 801 ⊗ 3482 083 032 ⊗ 1878 085 741 ⬤ 3151 000 144	430 10 MFZ430 430WGTZ KZISZ-5	M1KA21D2 / M1KAH1DD / M1KB21C2 / M1KB21D1 / M1KB21J2 / M1KB21L1 / M1KB21L2 / M1KB21LC / M1KB23C2 / M1KB23CD / M1KB23J2 / M1KB23L1 / M1KB23L2 / M1KB23LD / M1KBH1A2 / M1KBH1C2 / M1KBH3D2 / M1KBH3DD / M1KBH3L2 / M1KCM3A2 / M1KCM3D2 / M1KCT1L2 / M1KD21D1 / M1KD21D2 / M1KE2121 / M1KE2122 / M1KE2322 / M2KB21CD / M2KB21L2 / M2KB21LD

EuroTech MT		01.92 - 08.98				
180 E 24 180 E 24 K 180 E 27 180 E 27 K 190 E 24 190 E 24 K 190 E 27 190 E 27 K	01.92-12.96 01.93-12.96 01.92-12.96 01.92-12.96 01.97-08.98 01.97-08.98 01.97-08.98 01.97-08.98	8360		3400 074 031 ⊗ 3482 078 134 ⊗ 1862 308 031 ⬤ 3151 000 144	400 10 MFZ400 380GSZ KZISZ-5	
180 E 30 R 190 E 30 190 E 30 K 400 E 30 T	01.92-12.96 01.97-08.98 01.97-08.98 01.92-08.98	8460		3400 107 031 ⊗ 3482 078 134 ⊗ 1862 317 031 ⬤ 3151 000 144	400 10 MFZ400 400GVZ KZISZ-5	Getr. / GBox: ZF
				3400 077 071 ⊗ 3482 078 134 ⊗ 1862 317 032 ⬤ 3151 000 144	400 10 MFZ400 400GVZ KZISZ-5	Getr. / GBox: Fuller
MT 180 E 34 R 400 E 34 T	01.92-12.93 01.92-08.98	8460		3400 084 031 ⊗ 3482 078 134 ⊗ 1878 032 032 ⬤ 3151 000 144	400 10 MFZ400 400WGTZ KZISZ-5	Getr. / GBox: ZF
				3400 077 071 ⊗ 3482 078 134 ⊗ 1862 317 032 ⬤ 3151 000 144	400 10 MFZ400 400GVZ KZISZ-5	Getr. / GBox: Fuller



















EuroTrakker		01.93 - 11.04				
MP 190 E 30 W MP 190 E 30 H MP 260 E 30 H	01.93-11.04 01.93-11.04 01.93-11.04	8460		3400 107 031 ⊗ 3482 078 134 ⊗ 1862 317 031 ⬤ 3151 000 144	400 10 MFZ400 400GVZ KZISZ-5	
MP 190 E 31 H Cursor MP 190 E 31 W Cursor MP 190 E 31 H Cursor	09.99-11.04 09.99-11.04 09.99-11.04	F2BE0681		3400 084 031 ⊗ 3482 078 134 ⊗ 1878 032 032 ⬤ 3151 000 144	400 10 MFZ400 400WGTZ KZISZ-5	Getr. / GBox: 12AS 1800 DD K0PB12C1 / K0PB13C1 / K0PB14C1
				3400 107 031 ⊗ 3482 078 134 ⊗ 1862 317 031 ⬤ 3151 000 144	400 10 MFZ400 400GVZ KZISZ-5	Getr. / GBox: 16S 109 K0PA14A2 / K0PA15A2 / K0PA17A2 / K0PB12A3 / K0PB12A5 / K0PB12B1 / K0PB13A3 / K0PB13A5 / K0PB13B1 / K0PB14A3 / K0PB14B1 / K0PE12A3 / K0PA12A2 / K0PA13A2 / K0PA13A3
				3400 107 031 ⊗ 3482 078 134 ⊗ 1862 317 031 ⬤ 3151 000 144	400 10 MFZ400 400GVZ KZISZ-5	Getr. / GBox: 9S 109 K0PA14A1 / K0PA14D1 / K0PA15A1 / K0PB12A1 / K0PB12G3 / K0PB14A1 / K0PA12A1 / K0PA13A1
		F2BE0681B		3400 700 313 ⊗ 3482 083 113 ⊗ 1878 054 951 ⬤ 3151 000 144	430 10 MFZ430 430GTZ KZISZ-5	K0DA12A5 / K0DA12E5 / K0DA13A5 / K0DA13C5 / K0DA13D5 / K0DA14A5 / K0DA14AE / K0DA14E5 / K0DA15A5 / K0DA15D5 / K0DA15E5 / K0DA16A5 / K0DB12AE / K0DB13A5 / K0DB13D5 / K0DB14A5

		CODE				
--	--	------	--	---	---	---

IVECO

EuroTrakker		01.93 - 11.04					
MP 190 E 31 W Cursor	09.99 - 11.04	F2BE0681		3400 084 031 Ⓢ 3482 078 134 Ⓢ 1878 032 032 Ⓢ 3151 000 144	400 10 MFZ400 400WGTZ KZISZ-5	Getr. / GBox: 12AS 1800 DD K0PB12C1 / K0PB13C1 / K0PB14C1	
				3400 107 031 Ⓢ 3482 078 134 Ⓢ 1862 317 031 Ⓢ 3151 000 144	400 10 MFZ400 400GVZ KZISZ-5	Getr. / GBox: 9S 109 K0PA12A1 / K0PA13A1 / K0PA14A1 / K0PA14D1 / K0PA15A1 / K0PB12A1 / K0PB12G3 / K0PB14A1	
				3400 107 031 Ⓢ 3482 078 134 Ⓢ 1862 317 031 Ⓢ 3151 000 144	400 10 MFZ400 400GVZ KZISZ-5	Getr. / GBox: 16S 109 K0PA12A2 / K0PA13A2 / K0PA13A3 / K0PA14A2 / K0PA15A2 / K0PA17A2 / K0PB12A3 / K0PB12A5 / K0PB12B1 / K0PB13A3 / K0PB13A5 / K0PB13B1 / K0PB14A3 / K0PB14B1 / K0PE12A3	
MP 190 E 34 H	01.93 - 11.04	8460		3400 077 071 Ⓢ 3482 078 134 Ⓢ 1862 317 032 Ⓢ 3151 000 144	400 10 MFZ400 400GVZ KZISZ-5	Getr. / GBox: Fuller	
MP 190 E 34 W	01.93 - 11.04						
MP 260 E 34 H	01.93 - 11.04						
MP 260 E 34 W	01.93 - 11.04			3400 084 031 Ⓢ 3482 078 134 Ⓢ 1878 032 032 Ⓢ 3151 000 144	400 10 MFZ400 400WGTZ KZISZ-5	Getr. / GBox: ZF	
MP 340 E 34 H	01.93 - 11.04						
MP 380 E 34 H	01.93 - 11.04						
MP 400 E 34 HT	01.93 - 11.04						
MP 440 E 34 HT	01.93 - 11.04						
MP 190 E 35 H Cursor	09.99 - 11.04	F2BE0681		3400 084 031 Ⓢ 3482 078 134 Ⓢ 1878 032 032 Ⓢ 3151 000 144	400 10 MFZ400 400WGTZ KZISZ-5	Getr. / GBox: 12AS 2301 DD K0RB13K3 / K0RE12K3	
MP 190 E 35 H Cursor	09.99 - 11.04						
MP 190 E 35 W Cursor	09.99 - 11.04						
MP 190 E 35 W Cursor	09.99 - 11.04						
				3400 084 031 Ⓢ 3482 078 134 Ⓢ 1878 032 032 Ⓢ 3151 000 144	400 10 MFZ400 400WGTZ KZISZ-5	Getr. / GBox: 16S 151+INT K0RB14B3	
				3400 084 031 Ⓢ 3482 078 134 Ⓢ 1878 032 032 Ⓢ 3151 000 144	400 10 MFZ400 400WGTZ KZISZ-5	Getr. / GBox: 16S 151 K0RA12A1 / K0RA12A2 / K0RA13A1 / K0RA13A2 / K0RA13D1 / K0RA13H1 / K0RA14A1 / K0RA14A2 / K0RA14A4 / K0RA15A1 / K0RA15A2 / K0RB12A3 / K0RB13A1 / K0RB13A3 / K0RB13D1 / K0RB14A1 / K0RB14A3 / K0RB14D1	
MP 190 E 37 H	01.93 - 11.04	8210.42K.		3400 700 455 ■	430 10	Nabenprofil / Hub Profile: 41,1x50,8-10N	(46)
MP 190 E 37 W	01.93 - 11.04						
MP 190 E 38 W Cursor	01.01 - 11.04	F3AE0681		3400 117 801 Ⓢ 3482 083 032 Ⓢ 1878 085 741 Ⓢ 3151 000 144	430 10 MFZ430 430WGTZ KZISZ-5	K0LB12H3 / K0LB12H5 / K0LB13C3 / K0LB14C3 / K0LB14H3 / K0LA12C2 / K0LA13C2 / K0LA13C4 / K0LA14C2 / K0LA15C2 / K0LB12C3	
MP 190 E 38 W Cursor	01.01 - 11.04						
MP 190 E 42 H	01.93 - 11.04	8210		3400 700 455 ■	430 10	Getr. / GBox: Fuller Nabenprofil / Hub Profile: 41,1x50,8-10N	(46)
MP 190 E 42 W	01.93 - 11.04						
MP 260 E 37 H	01.93 - 11.04			3400 117 801 Ⓢ 3482 083 032 Ⓢ 1878 085 741 Ⓢ 3151 000 144	430 10 MFZ430 430WGTZ KZISZ-5	Getr. / GBox: ZF	
MP 260 E 37 W	01.93 - 11.04						
MP 260 E 42 H	01.93 - 11.04						
MP 260 E 42 W	01.93 - 11.04						
MP 380 E 37 W	01.93 - 11.04						
MP 380 E 37 H	01.93 - 11.04						
MP 410 E 37 H	01.93 - 11.04						
MP 440 E 37 HT	01.93 - 11.04						
MP 440 E 42 HT	01.93 - 11.04						
MP 720 E 37 HT	01.93 - 11.04						
MP 720 E 37 WT	01.93 - 11.04						
MP 720 E 42 HT	01.93 - 11.04						
MP 720 E 42 WT	01.93 - 11.04						
MP 190 E 44 W Cursor	09.00 - 11.04	F3AE0681		3400 117 801 Ⓢ 3482 083 032 Ⓢ 1878 085 741 Ⓢ 3151 000 144	430 10 MFZ430 430WGTZ KZISZ-5	K0MA12C2 / K0MA13C2 / K0MA14C2 / K0MB12C3 / K0MB12C5 / K0MB12D3 / K0MB12D5 / K0MB12H3 / K0MB12H5 / K0MB13C3 / K0MB13H3 / K0MB13H5 / K0MB14C3 / K0MB14C5	
MP 190 E 44 W Cursor	09.00 - 11.04						

IVECO

EuroTrakker		01.93 - 11.04			
MP 260 E 31 H Cursor	09.99 - 11.04	F2BE0681	 3400 084 031 3482 078 134 1878 032 032 3151 000 144	400 10 MFZ400 400WGTZ KZISZ-5	Getr. / GBox: 12AS 1800 DD K1PA14C1 / K1PA14JD / K1PA14PD / K1PC73JD
MP 260 E 31 H Cursor	09.99 - 11.04		 3400 107 031 3482 078 134 1862 317 031 3151 000 144	400 10 MFZ400 400GVZ KZISZ-5	Getr. / GBox: 9S 109 K1PA14A1 / K1PA14AD / K1PA14G2 / K1PA14GA / K1PA15AD / K1PA16G1 / K1PA16G2 / K1PA17AD / K1PA17G2 / K1PA17GA / K1PA72A1 / K1PA72G2 / K1PA73A1 / K1PA74G2 / K1PC74GD
MP 260 E 31 HB Cursor	11.99 - 11.04		 3400 107 031 3482 078 134 1862 317 031 3151 000 144	400 10 MFZ400 400GVZ KZISZ-5	Getr. / GBox: 16S 109 K1PA12B1 / K1PA13A2 / K1PA14A2 / K1PA14B1 / K1PA15A2 / K1PA15B1 / K1PA15G2 / K1PA16A2 / K1PA16B1 / K1PA17A2 / K1PA17B1 / K1PA12A2
			 3400 084 031 3482 078 134 1878 032 032 3151 000 144	400 10 MFZ400 400WGTZ KZISZ-5	Getr. / GBox: 12AS 2301 DD K1PA13K2 / K1PA14KA / K1PA15KA
MP 260 E 35 H Cursor	01.00 - 11.04	F2BE0681	 3400 084 031 3482 078 134 1878 032 032 3151 000 144	400 10 MFZ400 400WGTZ KZISZ-5	Getr. / GBox: 12AS 1800 DD K1RA16C1 / K1RA17C1
MP 260 E 35 H Cursor	01.00 - 11.04		 3400 084 031 3482 078 134 1878 032 032 3151 000 144	400 10 MFZ400 400WGTZ KZISZ-5	Getr. / GBox: 16S 151+INT K1RA14N1
MP 260 E 35 W Cursor	09.99 - 11.04		 3400 084 031 3482 078 134 1878 032 032 3151 000 144	400 10 MFZ400 400WGTZ KZISZ-5	Getr. / GBox: 16S 151 K1RA12A2 / K1RA13A1 / K1RA13A2 / K1RA13A4 / K1RA14A1 / K1RA14A2 / K1RA15A1 / K1RA15A2 / K1RA16A2 / K1RA16A4 / K1RA17A1 / K1RA17A2 / K1RA17AA / K1RA72A2 / K1RA73A2 / K1RA74A2 / K1RB13A1 / K1RB13A3 / K1RB14A1 / K1RB14A3
			 3400 084 031 3482 078 134 1878 032 032 3151 000 144	400 10 MFZ400 400WGTZ KZISZ-5	Getr. / GBox: 12AS 2301 DD K1RA12K2 / K1RA14K2 / K1RA15K2 / K1RA17K2
MP 260 E 35 W Cursor	09.99 - 11.04	F2BE0681	 3400 084 031 3482 078 134 1878 032 032 3151 000 144	400 10 MFZ400 400WGTZ KZISZ-5	Getr. / GBox: 12AS 1800 DD K1RA16C1 / K1RA17C1
			 3400 084 031 3482 078 134 1878 032 032 3151 000 144	400 10 MFZ400 400WGTZ KZISZ-5	Getr. / GBox: 16S 151+INT K1RA14N1
			 3400 084 031 3482 078 134 1878 032 032 3151 000 144	400 10 MFZ400 400WGTZ KZISZ-5	Getr. / GBox: 16S 151 K1RA12A2 / K1RA13A1 / K1RA13A4 / K1RA14A1 / K1RA14A2 / K1RA15A1 / K1RA15A2 / K1RA16A2 / K1RA16A4 / K1RA17A1 / K1RA17A2 / K1RA17AA / K1RA72A2 / K1RA73A2 / K1RA74A2 / K1RB13A1 / K1RB13A3 / K1RB14A1 / K1RB14A3
			 3400 084 031 3482 078 134 1878 032 032 3151 000 144	400 10 MFZ400 400WGTZ KZISZ-5	Getr. / GBox: 12AS 2301 DD K1RA12K2 / K1RA14K2 / K1RA15K2 / K1RA17K2
MP 260 E 38 H Cursor	01.01 - 11.04	F3AE0681	 3400 117 801 3482 083 032 1878 085 741 3151 000 144	430 10 MFZ430 430WGTZ KZISZ-5	K1LA12C2 / K1LA12D2 / K1LA12H2 / K1LA13C2 / K1LA13C4 / K1LA13H2 / K1LA14C2 / K1LA14C4 / K1LA14D2 / K1LA14H2 / K1LA15C2 / K1LA15C4 / K1LA15H2 / K1LA15H4 / K1LA16C2 / K1LA16C4 / K1LA16H2 / K1LA17C2 / K1LA17C4 / K1LA17D2 / K1LB13C3 / K1LB13C5 / K1LB13H3 / K1LB13H5 / K1LB14C3 / K1LB14C5 / K1LB14H3 / K1LB14H5
MP 260 E 38 H Cursor	01.01 - 11.04		 3400 117 801 3482 083 032 1878 085 741 3151 000 144	430 10 MFZ430 430WGTZ KZISZ-5	K1MA12C2 / K1MA12C4 / K1MA12D2 / K1MA12D4 / K1MA12H2 / K1MA12H4 / K1MA13C2 / K1MA13C4 / K1MA13D4 / K1MA14C2 / K1MA14C4 / K1MA14D2 / K1MA14H2 / K1MA14H4 / K1MA15C2 / K1MA15C4 / K1MA15D2 / K1MA15D4 / K1MA15H2 / K1MA16C2 / K1MA17C2 / K1MA17C4 / K1MA17J2 / K1MB13C3 / K1MB13C5 / K1MB13H3 / K1MB13H5 / K1MB14C3 / K1MB14H3
MP 260 E 38 W Cursor	01.01 - 11.04		 3400 117 801 3482 083 032 1878 085 741 3151 000 144	430 10 MFZ430 430WGTZ KZISZ-5	K1MA12C2 / K1MA12C4 / K1MA12D2 / K1MA12D4 / K1MA12H2 / K1MA12H4 / K1MA13C2 / K1MA13C4 / K1MA13D4 / K1MA14C2 / K1MA14C4 / K1MA14D2 / K1MA14H2 / K1MA14H4 / K1MA15C2 / K1MA15C4 / K1MA15D2 / K1MA15D4 / K1MA15H2 / K1MA16C2 / K1MA17C2 / K1MA17C4 / K1MA17J2 / K1MB13C3 / K1MB13C5 / K1MB13H3 / K1MB13H5 / K1MB14C3 / K1MB14H3
MP 260 E 38 W Cursor	01.01 - 11.04		 3400 117 801 3482 083 032 1878 085 741 3151 000 144	430 10 MFZ430 430WGTZ KZISZ-5	K1MA12C2 / K1MA12C4 / K1MA12D2 / K1MA12D4 / K1MA12H2 / K1MA12H4 / K1MA13C2 / K1MA13C4 / K1MA13D4 / K1MA14C2 / K1MA14C4 / K1MA14D2 / K1MA14H2 / K1MA14H4 / K1MA15C2 / K1MA15C4 / K1MA15D2 / K1MA15D4 / K1MA15H2 / K1MA16C2 / K1MA17C2 / K1MA17C4 / K1MA17J2 / K1MB13C3 / K1MB13C5 / K1MB13H3 / K1MB13H5 / K1MB14C3 / K1MB14H3
MP 340 E 35 H Cursor	09.99 - 11.04	F2BE0681	 3400 084 031 3482 078 134 1878 032 032 3151 000 144	400 10 MFZ400 400WGTZ KZISZ-5	Getr. / GBox: 12AS 1800 DD K4RA13CD
MP 340 E 35 H Cursor	09.99 - 11.04		 3400 084 031 3482 078 134 1878 032 032 3151 000 144	400 10 MFZ400 400WGTZ KZISZ-5	Getr. / GBox: 16S 151 K4RA11A2 / K4RA13A2 / K4RA13AA / K4RA13DD / K4RA14A1 / K4RA14AA / K4RA71A1 / K4RA71A2 / K4RA73A1 / K4RA73A2
MP 340 E 35 HB Cursor	01.01 - 11.04		 3400 084 031 3482 078 134 1878 032 032 3151 000 144	400 10 MFZ400 400WGTZ KZISZ-5	Getr. / GBox: 12AS 2301 DD K4RA13KA / K4RF13KA / K4RF14KC



























IVECO







EuroTrakker		01.93 - 11.04					
MP 340 E 37 H	01.93 - 11.04	8210.42K(TCA), 8210.42K., 8210.42L.		3400 700 455 ■	430 10	Getr. / GBox: Fuller Nabenprofil / Hub Profile: 41,1x50,8-10N	(46)
MP 340 E 42 H	01.93 - 11.04			3400 117 801	430 10	Getr. / GBox: ZF	
MP 400 E 37 HT	01.93 - 11.04			⊕ 3482 083 032 ⊕ 1878 085 741 ⊕ 3151 000 144	MFZ430 430WGTZ KZISZ-5		
MP 400 E 37 WT	01.93 - 11.04						
MP 340 E 38 H Cursor	01.01 - 11.04	F3AE0681		3400 117 801	430 10	K4LA11C2 / K4LA11D2 / K4LA11H2 / K4LA12C2 / K4LA12H2 / K4LA13C2 / K4LA13CA / K4LA13DA / K4LA13HA / K4LA13JA / K4LA17C2 / K4LA72C2 / K4LA73C2 / K4LF13CA	
MP 340 E 38 H Cursor	01.01 - 11.04			⊕ 3482 083 032 ⊕ 1878 085 741 ⊕ 3151 000 144	MFZ430 430WGTZ KZISZ-5		
MP 340 E 38 HB Cursor	01.01 - 11.04						
MP 340 E 44 H Cursor	01.01 - 11.04	F3AE0681		3400 117 801	430 10	K4MA11C2 / K4MA11D2 / K4MA11H2 / K4MA11J2 / K4MA12C2 / K4MA12D2 / K4MA12H2 / K4MA12J2 / K4MA13C2 / K4MA13C4 / K4MA13CA / K4MA13D2 / K4MA13H2 / K4MA13H4 / K4MA13HA / K4MA13J4 / K4MA14CC / K4MA71C2 / K4MA72C2 / K4MA73C2	
MP 340 E 44 H Cursor	01.01 - 11.04			⊕ 3482 083 032 ⊕ 1878 085 741 ⊕ 3151 000 144	MFZ430 430WGTZ KZISZ-5		
MP 340 E 44 HB Cursor	01.01 - 11.04						
MP 380 E 31				3400 700 313	430 10	K3DA13A5 / K3DA13B5 / K3DA13E5 / K3DA14A5 / K3DA14E5 / K3DA15A5	
				⊕ 3482 083 113 ⊕ 1878 054 951 ⊕ 3151 000 144	MFZ430 430GTZ KZISZ-5		
MP 380 E 38 W Cursor	01.01 - 11.04	F3AE0681		3400 117 801	430 10	K3LA12D2 / K3LA12H2 / K3LA13C2 / K3LA13C4 / K3LA13D2 / K3LA13E2 / K3LA13H2 / K3LA14C2 / K3LA14D2 / K3LA14H2 / K3LA15C2 / K3LA15C4 / K3LA15E2 / K3LA15H2 / K3LA74C2 / K3LB13C3 / K3LB13H3 / K3LB14C3	
				⊕ 3482 083 032 ⊕ 1878 085 741 ⊕ 3151 000 144	MFZ430 430WGTZ KZISZ-5		
MP 380 E 38 H Cursor	01.01 - 11.04	F3AE0681		3400 117 801	430 10	K3LA12C2 / K3LA12D2 / K3LA12H2 / K3LA13C2 / K3LA13C4 / K3LA13D2 / K3LA13E2 / K3LA13H2 / K3LA14C2 / K3LA14D2 / K3LA14H2 / K3LA15C2 / K3LA15C4 / K3LA15E2 / K3LA15H2 / K3LA74C2 / K3LB13C3 / K3LB13H3 / K3LB14C3 / K3LB14H3	
MP 380 E 38 H Cursor	01.01 - 11.04			⊕ 3482 083 032 ⊕ 1878 085 741 ⊕ 3151 000 144	MFZ430 430WGTZ KZISZ-5		
MP 380 E 38 W Cursor	01.01 - 11.04						
MP 380 E 42 H	01.93 - 11.04	8210		3400 700 455 ■	430 10	Getr. / GBox: Fuller Nabenprofil / Hub Profile: 41,1x50,8-10N	(46)
MP 380 E 42 W	01.93 - 11.04			3400 117 801	430 10	Getr. / GBox: ZF	
				⊕ 3482 083 032 ⊕ 1878 085 741 ⊕ 3151 000 144	MFZ430 430WGTZ KZISZ-5		
		8210.42L.		3483 023 003 ⊕	445	K3FD14J1 für Fahrzeuge mit Wandlerschaltkupplung / for vehicles with converter and clutch unit	(76)
				1878 051 801	445 24	K3FD14J1 für Fahrzeuge mit Wandlerschaltkupplung / for vehicles with converter and clutch unit	(76)
				445GTZC			
MP 380 E 44 H Cursor	01.01 - 11.04	F3AE0681		3400 117 801	430 10	K3SA12C2 / K3SA12C4 / K3SA12D2 / K3SA12D4 / K3SA12H2 / K3SA13C2 / K3SA13H4 / K3SA15C2 / K3SA15C4	
MP 380 E 44 H Cursor	01.01 - 11.04			⊕ 3482 083 032 ⊕ 1878 085 741 ⊕ 3151 000 144	MFZ430 430WGTZ KZISZ-5		
MP 380 E 44 W Cursor	01.01 - 11.04						
MP 380 E 44 W Cursor	01.01 - 11.04						
MP 400 E 31				3400 700 313	430 10	K0DA21A5 / K0DA21AE / K0DA21D5 / K0DB23D5	
				⊕ 3482 083 113 ⊕ 1878 054 951 ⊕ 3151 000 144	MFZ430 430GTZ KZISZ-5		
MP 400 E 42 HT	01.93 - 11.04	8460		3400 700 455 ■	430 10	Getr. / GBox: Fuller Nabenprofil / Hub Profile: 41,1x50,8-10N	(46)
MP 400 E 42 WT	01.93 - 11.04			3400 117 801	430 10	Getr. / GBox: ZF	
				⊕ 3482 083 032 ⊕ 1878 085 741 ⊕ 3151 000 144	MFZ430 430WGTZ KZISZ-5		
MP 410 E 38 H Cursor	01.01 - 11.04	F3AE0681		3400 117 801	430 10	K5LA11C2 / K5LA11D2 / K5LA11E2 / K5LA11H2 / K5LA12C2 / K5LA12D2 / K5LA12H2 / K5LA13C2 / K5LA13E2 / K5LA13E3 / K5LA13H2 / K5LA14C2 / K5LA71C2 / K5LA73C2	
MP 410 E 38 H Cursor	01.01 - 11.04			⊕ 3482 083 032 ⊕ 1878 085 741 ⊕ 3151 000 144	MFZ430 430WGTZ KZISZ-5		
MP 410 E 42 H	01.93 - 11.04	8210		3400 700 455 ■	430 10	Getr. / GBox: Fuller Nabenprofil / Hub Profile: 41,1x50,8-10N	(46)
MP 410 E 42 W	01.93 - 11.04			3400 117 801	430 10	Getr. / GBox: ZF	
					⊕ 3482 083 032 ⊕ 1878 085 741 ⊕ 3151 000 144	MFZ430 430WGTZ KZISZ-5	
			8210.42L(TCA), 8210.42L.		3483 023 003 ⊕	445	K5FD12B1 für Fahrzeuge mit Wandlerschaltkupplung / for vehicles with converter and clutch unit
				1878 051 801	445 24	K5FD12B1 für Fahrzeuge mit Wandlerschaltkupplung / for vehicles with converter and clutch unit	(76)
				445GTZC			
MP 410 E 44 H Cursor	01.01 - 11.04	F3AE0681		3400 117 801	430 10	K5MA12C3 / K5MA12C4 / K5MA12D2 / K5MA12H2 / K5MA12H4 / K5MA12J4 / K5MA13C2 / K5MA13C4 / K5MA13D2 / K5MA13H2 / K5MA13J2 / K5MA14C2 / K5MA14C3 / K5MA14C4 / K5MA14H2 / K5MA14H4 / K5MA14J4 / K5MA71C2 / K5MA73C2 / K5MB12C3 / K5MB12H3 / K5MA11C2 / K5MA11C3 / K5MA11C4 /	
				⊕ 3482 083 032 ⊕ 1878 085 741 ⊕ 3151 000 144	MFZ430 430WGTZ KZISZ-5		

		CODE				
--	--	------	--	---	---	---

IVECO

EuroTrakker		01.93 - 11.04		
MP 720 E 31		 3400 700 313  3482 083 113  1878 054 951  3151 000 144	430 10 MFZ430 430GTZ KZISZ-5	K3DA22A5 / K3DA23A5 / K3DA23D5 / K3DA23E5 / K3DA23EE









M		06.82 - 12.92			
115-17	09.83 - 12.85	8060	 3482 905 001	330 MF330	->11.1985 Getr. / GBox: Fiat
135-17	09.83 - 12.85		 1862 973 002	330 10 330CPB	->11.1985 Getr. / GBox: Fiat
135-17 T	09.83 - 12.85		 3151 000 395	KZIS-4	->11.1985 Getr. / GBox: Fiat
115-17	01.86 - 12.91	8060	 3482 905 001	330 MF330	Getr. / GBox: Fiat,ZF
115-17 H	01.86 - 12.91		 1862 973 002	330 10 330CPB	Getr. / GBox: Fiat,ZF
135-17	01.86 - 12.91	8060	 3482 905 001	330 MF330	Getr. / GBox: Fiat, ZF
135-17 H	01.86 - 12.92		 1862 973 002	330 10 330CPB	Getr. / GBox: Fiat, ZF
135-17 T	01.86 - 12.91		 3151 196 031	KZIS-4	Getr. / GBox: Fiat, ZF
145-17	02.86 - 12.91				
159-17	07.82 - 09.86	8360	 3482 038 031	350 GMF350	Getr. / GBox: ZF
			 1861 742 032	350 10 350GTB	Getr. / GBox: ZF
			 3151 196 031	KZIS-4	Getr. / GBox: ZF
165-24 R	06.82 - 09.86	8220.22.002,	 1882 325 139	380 G380	
165-24 R	01.85 - 12.85	8220.22.102	 1878 000 957	380 10 380GTZ	
165-24 T	06.82 - 09.86		 3151 114 031	KZI-4,5	Getr. / GBox: ZF
			 3151 127 031	KZI-4,5	Getr. / GBox: Fuller
175-17	09.86 - 12.92	8060	 3482 905 001	330 MF330	Getr. / GBox: ZF
			 1862 973 002	330 10 330CPB	Getr. / GBox: ZF
			 3151 196 031	KZIS-4	Getr. / GBox: ZF
175-24	09.86 - 11.92	8460	 1882 325 139	380 G380	
175-24 T	09.86 - 11.92		 1878 000 957	380 10 380GTZ	
			 3151 127 031	KZI-4,5	Getr. / GBox: Fuller
			 3151 114 031	KZI-4,5	Getr. / GBox: ZF

MK		01.83 - 12.91			
75-9 A	01.83 - 05.89	F4L913,	 3151 199 001	KZIS-3	
75-9 H	01.83 - 08.85	BF4L913T			
80-13 A	01.83 - 12.91	BF6L913T	 3482 008 036 #	310 MF310	
80-13 A	01.83 - 12.91		 1861 577 136 #	310 10 310GTD	
80-13 AH	01.83 - 12.91		 3151 199 001	KZIS-3	
80-13 AT	01.83 - 12.91				
90-13 A	01.83 - 12.91				
90-13 AH	01.83 - 12.91				
110-13 A	01.83 - 12.91				
110-13 AH	01.83 - 12.85				
80-13 AW	01.83 - 12.91	BF6L913T	 3482 008 033	310 MF310	
80-13 AW	01.83 - 12.89		 1861 577 136 #	310 10 310GTD	
			 3151 199 001	KZIS-3	



		CODE				
--	--	------	--	---	---	---

IVECO













MK 01.83 - 12.91

80-16 A	01.83-12.91	BF6L913		3482 038 031	350 GMF350		
80-16 A	01.83-12.91						
80-16 AW	01.86-12.89			1861 742 032	350 10 350GTB		
80-16 AW	01.86-12.89						
110-16 A	01.83-12.91			3151 199 001	KZIS-3		
110-16 AH	01.83-12.91						
110-16 AT	01.83-12.85						
130-13 A	01.83-12.91	BF6L913T		3482 008 036 #	310 MF310	für / for: Version 42231628 für / for: Version 42231929	(68) (68)
130-13 AH	01.83-12.91						
				1861 577 136 #	310 10 310GTD	für / for: Version 42231628 für / for: Version 42231929	(68) (68)
				3151 199 001	KZIS-3	für / for: Version 42231628 für / for: Version 42231929	(68) (68)
130-16 A	01.83-12.91	BF6L913		3482 038 031	350 GMF350	für / for: Version 42231628 für / for: Version 42231929	(68) (68)
130-16 AH	01.83-12.91						
				1861 742 032	350 10 350GTB	für / for: Version 42231628 für / for: Version 42231929	(68) (68)
				3151 199 001	KZIS-3	für / for: Version 42231628 für / for: Version 42231929	(68) (68)

OM 35 - 616































OM 35	01.85-			1878 600 834	250 10 250CB		
OM 40 /35	05.76-12.85						
OM 40	05.76-						
OM 45	01.85-						
OM 50	01.85-						
OM 616	05.76-						
OM 55				1878 600 841	280 10 280CTB		
OM 65							
OM 70							
OM 75							

P/PA 12.79 - 12.93

159-17 H	07.82-09.86	8360		3482 038 031	350 GMF350	Getr. / GBox: ZF						
									1861 742 032	350 10 350GTB	Getr. / GBox: ZF	
									3151 196 031	KZIS-4	Getr. / GBox: ZF	
160-23 AH	04.84-05.89	F8L413F		3482 124 531	430 GMF430							
									1882 316 035 ●#	420 GF420		
									1878 001 138	420 10 420GTZ		
									3151 000 515	KZIS-4		
									1882 306 136 #	420 G420N	für Nebenantrieb / for PTO	(82)
									1861 643 134 #	420 10 420GSZ	für Nebenantrieb / for PTO	(82)
160-23 AHW	01.85-12.85	F8L413F		1882 325 139	380 G380							
									1878 000 957	380 10 380GTZ		
									3151 000 515	KZIS-4		































		CODE				
--	--	------	--	---	---	---

IVECO

P/PA		12.79 - 12.93					
160-23 AHW	04.84 - 05.89	F8L413F	 1882 325 139	380 G380	->01.1986		
			 1878 000 957	380 10 380GTZ	->01.1986		
			 3482 124 531	430 GMF430	02.1986->		
			 1882 316 035 ●#	420 GF420	02.1986->		
			 1878 001 138	420 10 420GTZ	02.1986->		
			 3151 000 515	KZIS-4			
			 1882 306 136 #	420 G420N	02.1986-> für Nebenantrieb / for PTO		(82)
			 1861 643 134 #	420 10 420GSZ	02.1986-> für Nebenantrieb / for PTO		(82)
160-30 AH	06.86 - 05.89	BF8L513	 3482 124 516	430 GMF430	Getr. / GBox: ZF		
			 1878 002 955	420 10 420GTZ	Getr. / GBox: ZF		
			 3151 000 515	KZIS-4	Getr. / GBox: ZF		
160-30 AH 160-30 AHW	06.86 - 05.89 06.86 - 05.89	BF8L513	 3482 124 516	430 GMF430	Getr. / GBox: ZF		
			 1878 002 955	420 10 420GTZ	Getr. / GBox: ZF		
			 3151 000 515	KZIS-4	Getr. / GBox: ZF		
170-23 AH	04.88 - 12.90	F8L513	 3482 124 531	430 GMF430			
			 1878 001 138	420 10 420GTZ			
			 3151 000 515	KZIS-4			
170-23 AHW 170-23 AHW,180-23 AHW	04.88 - 12.90 01.91 - 12.93	F8L513F	 1882 325 139	380 G380	Getr. / GBox: ZF		
			 1878 000 957	380 10 380GTZ	Getr. / GBox: ZF		
			 3482 124 531	430 GMF430	Getr. / GBox: ZF		
			 1882 316 035 ●#	420 GF420	Getr. / GBox: ZF		
			 1878 001 138	420 10 420GTZ	Getr. / GBox: ZF		
			 3151 000 515	KZIS-4	Getr. / GBox: ZF		
170-23 AH,180-23 AH 170-34 AH 170-34 AH 170-34 AH 170-34 AHW 170-34 AH,180-34 AH 170-34 AHW,180-34 AHW	01.91 - 12.93 04.89 - 12.90 04.89 - 12.90 01.91 - 12.93 04.89 - 12.90 01.91 - 12.93 01.91 - 12.93	BF8L513, F8L513	 3482 124 516	430 GMF430			
			 1878 002 955	420 10 420GTZ			
			 3151 000 515	KZIS-4			
170-25 AH 170-25 AHW 170-25 AHW,180-25 AHW	03.89 - 12.90 03.89 - 12.90 01.91 - 12.93	F8L513F	 3482 124 531	430 GMF430	Getr. / GBox: ZF		
			 1882 316 035 ●#	420 GF420	Getr. / GBox: ZF		
			 1878 001 138	420 10 420GTZ	Getr. / GBox: ZF		
			 3151 000 515	KZIS-4	Getr. / GBox: ZF		















		CODE				
--	--	------	--	---	---	---

IVECO

P/PA		12.79 - 12.93				
170-25 AH,180-25 AH	01.91 - 12.93	F8L413F	 1882 306 136 #	420 G420N	für Nebenantrieb / for PTO	(82)
			 1861 643 134 #	420 10 420GSZ	für Nebenantrieb / for PTO	(82)
		F8L513F	 3482 124 531	430 GMF430	Getr. / GBox: ZF	
			 1882 316 035 ●#	420 GF420	Getr. / GBox: ZF	
			 1878 001 138	420 10 420GTZ	Getr. / GBox: ZF	
			 3151 000 515	KZIS-4	Getr. / GBox: ZF	
190-25 AH	07.83 - 06.86	F8L413F	 3482 124 531	430 GMF430	Getr. / GBox: ZF	
190-25 AH	07.83 - 06.86		 1882 316 035 ●#	420 GF420	Getr. / GBox: ZF	
190-25 AHW	07.83 - 06.86		 1878 001 138	420 10 420GTZ	Getr. / GBox: ZF	
190-25 AHW	07.83 - 06.86		 3151 000 515	KZIS-4	Getr. / GBox: ZF	
190-30 H	04.87 - 12.90		8210	 3482 125 131	420 MF420	Getr. / GBox: Fuller enthält Druckplattenbefestigungsschrauben / includes bolt for pressure plate mounting
190-30 H	01.91 - 12.92	 1878 002 955		420 10 420GTZ	Getr. / GBox: Fuller	
190-30 H	04.87 - 12.90	 3151 000 515		KZIS-4	Getr. / GBox: Fuller	
190-30 H	01.91 - 12.92					
190-30 HT	01.89 - 12.90	8210.22.236, 8210.22.535, 8210.22.537, 8210.22.511, 8210.22.521, 8210.22.523, 8210.22.525, 8210.22.210	 3400 042 031 ☹	420 10 MF420 420GTZ	enthält Druckplattenbefestigungsschrauben / includes bolt for pressure plate mounting	(64)
190-30 HT	01.90 - 12.92		 3482 125 131  1878 002 955  1874 015 200			
190-30 HW	04.87 - 12.90	8210.22.236, 8210.22.535, 8210.22.537, 8210.22.511, 8210.22.521, 8210.22.523, 8210.22.525, 8210.22.210	 3400 042 031 ☹	420 10 MF420 420GTZ	enthält Druckplattenbefestigungsschrauben / includes bolt for pressure plate mounting	(64)
190-30 HW	01.91 - 12.92		 3482 125 131  1878 002 955  1874 015 200			
190-32 AH	01.83 - 12.85	F10L413F	 3482 124 532	430 GMF430		
	01.83 - 12.85		 1878 002 955	420 10 420GTZ		
	01.83 - 12.85		 3151 000 515	KZIS-4		
	01.83 - 12.85					
260-25 AH	03.84 - 06.86	F8L413F	 3482 124 531	430 GMF430	Getr. / GBox: ZF	
260-25 AH	03.84 - 06.86		 1882 316 035 ●#	420 GF420	Getr. / GBox: ZF	
260-25 AH	03.84 - 06.86		 1878 001 138	420 10 420GTZ	Getr. / GBox: ZF	
260-25 AH	04.89 - 12.92		 3151 000 515	KZIS-4	Getr. / GBox: ZF	
260-25 AHW	03.84 - 06.86					
260-25 AHW	03.84 - 06.86					
260-25 AHB	12.79 - 10.85	F8L413F	 1882 325 139	380 G380	Getr. / GBox: ZF	
260-25 AHB	12.79 - 10.85		 1878 000 957	380 10 380GTZ	Getr. / GBox: ZF	
260-25 AHB	03.84 - 06.86		 3151 000 515	KZIS-4	Getr. / GBox: ZF	
260-25 AHB	03.84 - 06.86					

		CODE				
--	--	------	--	---	---	---

IVECO

P/PA		12.79 - 12.93					
260-30 AH	06.86 - 05.90	BF8L513		3482 124 516	430 GMF430	Getr. / GBox: ZF	
260-30 AH	06.86 - 05.90			1878 002 955	420 10 420GTZ	Getr. / GBox: ZF	
260-30 AH	06.86 - 05.90			3151 000 515	KZIS-4	Getr. / GBox: ZF	
260-30 AHT	06.86 - 05.90						
260-30 AHT	06.86 - 05.90						
260-30 AHW	06.86 - 05.90						
260-30 AHW	06.86 - 05.90						
260-34 AH	04.89 - 12.90						
260-34 AH	01.91 - 12.92						
260-34 AH	04.89 - 12.90						
260-34 AH	01.91 - 12.92						
260-34 AH	04.89 - 12.90						
260-34 AHT	04.89 - 12.90						
260-34 AHT	01.91 - 12.92						
260-34 AHT	04.89 - 12.90						
260-34 AHW	01.91 - 12.92						
260-32 AH	01.83 - 12.85	F10L413F		3482 124 532	430 GMF430	Getr. / GBox: ZF	
260-32 AH	01.83 - 12.85			1878 002 955	420 10 420GTZ	Getr. / GBox: ZF	
260-32 AH	01.83 - 12.85			3151 000 515	KZIS-4	Getr. / GBox: ZF	
260-32 AHT	01.83 - 12.85						
260-32 AHT	01.83 - 12.85						
260-32 AHW	01.83 - 12.85						
260-32 AHW	01.83 - 12.85						
300-30 AH	04.87 - 05.89	BF8L513		3482 124 516	430 GMF430		
300-30 AHB	04.87 - 05.89			1878 002 955	420 10 420GTZ		
				3151 000 515	KZIS-4		
330-30 H	01.88 - 12.90	8210		3400 118 901 ☾ ☉ 3482 125 131 ☉ 1878 003 661 ☾ 1874 015 200	420 10 MF420 420WGTZ	enthält Druckplattenbefestigungsschrauben / includes bolt for pressure plate mounting	(64)
330-30 H	01.91 - 12.92			1878 002 955 ●	420 10 420GTZ		
330-30 H	06.84 - 12.90			3151 000 515	KZIS-4		
330-30 H	06.84 - 12.92						
330-30 HT	01.88 - 12.90						
330-30 HT	01.91 - 12.92						
330-30 HT	01.88 - 12.90						
330-30 HT	01.88 - 12.92						
330-30 HW	01.88 - 12.90	8210.22X.523, 8210.22X.235		3400 042 031 ☾ ☉ 3482 125 131 ☉ 1878 002 955 ☾ 1874 015 200	420 10 MF420 420GTZ	enthält Druckplattenbefestigungsschrauben / includes bolt for pressure plate mounting	(64)
330-30 HW	01.91 - 12.92			3151 196 031	KZIS-4		
330-30 HW	01.88 - 12.90						
330-30 HW	01.88 - 12.92						



IVECO

P/PA 12.79 - 12.93





































330-36 H	01.89 - 12.90	8210.42.269,	3400 700 418 ⊗ 3483 020 035 ⊗ 1878 085 741	430 10 MFZ430 430WGTZ	Getr. / GBox: ZF	
330-36 H	01.91 - 12.92	8210.42.235,	3400 700 454 ■	430 10	Getr. / GBox: Fuller	
330-36 H	01.89 - 12.90	8210.42.270,			Nabenprofil / Hub Profile: 41,1x50,8-10N	(46)
330-36 H	01.89 - 12.92	8210.42.237,	3482 083 040	430 MFZ430	Getr. / GBox: ZF	
		8210.42.210	⊗ 3100 002 038 ⊗ 3151 123 031 ⊗ 3180 001 008	KZIZ5 KZI/Z-5	Getr. / GBox: Fuller	
					In 3483/3488 enthalten / Contained in 3483, 3488	(30)
			1888 063 137	380 GF2/380N	für Nebenantrieb / for PTO	(82)
			1862 304 033 ▽	380 10 380GV	enthält eine Kupplungsscheibe / This part number includes one clutch disc	(66)
					für Nebenantrieb / for PTO	(82)
			1882 019 133	380 GF2/380N	Lose Kupplungsscheibe / Loose clutch disc	(39)
			1859 250 101	380 GF2/380	In 1888 enthalten / Contained in 1888	(29)
			1862 305 033 △	380 10 380GVZ	In 1888 enthalten / Contained in 1888	(29)
330-36 HT	01.89 - 12.90	8210.42.269,	3400 700 418 ⊗ 3483 020 035 ⊗ 1878 085 741	430 10 MFZ430 430WGTZ	Getr. / GBox: Fuller	
		8210.42.235,	3482 083 040	430 MFZ430	Getr. / GBox: ZF	
		8210.42.271,			Getr. / GBox: Fuller	(30)
		8210.42.270,	⊗ 3100 002 038 ⊗ 3151 123 031 ⊗ 3180 001 008	KZIZ5 KZI/Z-5	In 3483/3488 enthalten / Contained in 3483, 3488	
		8210.42.237,			Getr. / GBox: ZF	(14)
		8210.42.210			Getr. / GBox: Fuller	
					Beinhaltet Ausrücker und Montagesatz / Contains releaser and fitting kit	
					In 3483/3488 enthalten / Contained in 3483, 3488	(30)
330-36 HT	01.91 - 12.92	8210.42.269,	3400 700 418 ⊗ 3483 020 035 ⊗ 1878 085 741	430 10 MFZ430 430WGTZ	Getr. / GBox: ZF	
330-36 HT	01.89 - 12.90	8210.42.235,	3400 700 454 ■	430 10	Getr. / GBox: Fuller	
330-36 HT	01.89 - 12.92	8210.42.271,			Nabenprofil / Hub Profile: 41,1x50,8-10N	(46)
330-36 HW	01.89 - 10.90	8210.42.270,	3482 083 040	430 MFZ430	Getr. / GBox: ZF	
330-36 HW	01.89 - 10.90	8210.42.237,			Getr. / GBox: Fuller	(30)
330-36 HW	01.89 - 12.92	8210.42.210	⊗ 3100 002 038 ⊗ 3151 123 031 ⊗ 3180 001 008	KZIZ5 KZI/Z-5	In 3483/3488 enthalten / Contained in 3483, 3488	
330-36 HW	01.91 - 12.92				Getr. / GBox: ZF	(14)
					Getr. / GBox: Fuller	
					Beinhaltet Ausrücker und Montagesatz / Contains releaser and fitting kit	
					In 3483/3488 enthalten / Contained in 3483, 3488	(30)
340-34 AH	03.89 - 12.92	BF8L513	3400 042 031 ☹ ⊗ 3482 125 131 ⊗ 1878 002 955 ⊗ 1874 015 200	420 10 MF420 420GTZ	enthält Druckplattenbefestigungsschrauben / includes bolt for pressure plate mounting	(64)
			3151 000 515	KZIS-4		

P/PA-Haubenfahrzeuge 12.79 - 12.93

120-13 ANW	01.83 - 09.90	F6L913, BF6L913T	1861 479 032 #	295 10 295GSZ		
			3151 199 001	KZIS-3		
120-16 ANW, 120-17 ANW	01.83 - 11.89	BF6L913	1861 479 032 #	295 10 295GSZ		
			3151 199 001	KZIS-3		
			1882 307 131	350 GF350	für / for: Version 42231628	(68)
			1878 001 070	350 10 350GTZ	für / for: Version 42231929	(68)
					für / for: Version 42231628	(68)
			3151 000 515	KZIS-4	für / for: Version 42231929	(68)
					für / for: Version 42231628	(68)

		CODE				
--	--	------	--	---	---	---





















IVECO

P/PA-Haubenfahrzeuge 12.79 - 12.93						
150-16 AN 150-16 ANW	01.83 - 12.91 01.83 - 12.91	BF6L913	 3482 038 031	350 GMF350	Getr. / GBox: ZF	
			 1861 742 032	350 10 350GTB	Getr. / GBox: ZF	
			 3151 000 395	KZIS-4	Getr. / GBox: ZF	
160-17 AN 160-17 ANW	07.89 - 12.93 07.89 - 12.93	BF6L913/U, BF6L913	 1882 307 131	350 GF350		
			 1878 001 070	350 10 350GTZ		
			 3151 000 515	KZIS-4		
160-23 ANW 160-23 ANW 160-23 ANW 160-23 ANW 160-23 ANW 170-23 ANW 190-25 ANT	04.84 - 12.85 01.86 - 05.89 04.84 - 12.85 04.85 - 12.85 01.88 - 05.89 04.88 - 12.90 07.86 - 12.87	F8L413F, F8L513	 1882 325 139	380 G380	79011212 / 79011232	
			 1878 000 957	380 10 380GTZ	79011212 / 79011232	
			 3151 000 515	KZIS-4	79011212 / 79011232	
			 1882 325 139	380 G380		
			 1878 000 957	380 10 380GTZ		
			 3151 000 515	KZIS-4		
170-23 ANW 170-23 ANW 170-23 ANW	01.91 - 12.93 01.90 - 12.90 01.91 - 12.93	F8L513	 1882 325 139	380 G380		
			 1878 000 957	380 10 380GTZ		
			 3151 000 515	KZIS-4		
			 1882 306 136 #	420 G420N	für Nebenantrieb / for PTO	(82)
			 3482 124 531	430 GMF430	->11.1984	
190-25 AN 190-25 AN	07.83 - 12.86 07.83 - 12.87	F8L413F	 1882 316 035 ●#	420 GF420	->11.1984	
			 1878 001 138	420 10 420GTZ	->11.1984	
			 3151 000 515	KZIS-4	->11.1984	
			 1882 306 136 #	420 G420N	für Nebenantrieb / for PTO	(82)
			 3482 124 531	430 GMF430	->11.1984	
190-25 AN 190-25 AN	07.83 - 06.86	F8L413F	 1882 316 035 ●#	420 GF420	->11.1984	
			 1878 001 138	420 10 420GTZ	->11.1984	
			 3151 000 515	KZIS-4	->11.1984	
			 3482 124 531	430 GMF430		
190-25 ANW 190-25 ANW	07.83 - 12.86 07.83 - 12.87	F8L413F	 1882 316 035 ●#	420 GF420		
			 1878 001 138	420 10 420GTZ	->11.1984	
			 1878 002 955	420 10 420GTZ	12.1984->	
			 3151 000 515	KZIS-4		
			 3482 124 531	430 GMF430		
190-25 ANW	01.86 - 09.90	F8L413F	 1882 316 035 ●#	420 GF420		
			 1878 002 955	420 10 420GTZ		
			 3151 000 515	KZIS-4		
			 3482 125 131	420 MF420	Getr. / GBox: Fuller enthält Druckplattenbefestigungsschrauben / includes bolt for pressure plate mounting	(64)
190-30 N 190-30 N 190-30 NT 190-30 NT	04.87 - 12.90 01.91 - 12.93 04.87 - 12.90 01.91 - 12.93	8210	 1878 002 955	420 10 420GTZ	Getr. / GBox: Fuller	
			 3151 000 515	KZIS-4	Getr. / GBox: Fuller	



		CODE				
--	--	------	--	---	---	---

IVECO

P/PA-Haubenfahrzeuge 12.79 - 12.93

260-25 AN 260-25 AN	07.83 - 06.86 07.83 - 06.86	F8L413F	 1882 325 139 <small>RHD</small> 380 G380	Getr. / GBox: ZF	
			 1878 000 957 <small>RHD</small> 380 10 380GTZ	Getr. / GBox: ZF	
			 3151 000 515 <small>RHD</small> KZIS-4	Getr. / GBox: ZF	
			 3482 124 531 430 GMF430	Getr. / GBox: ZF	
			 1882 316 035 # 420 GF420	Getr. / GBox: ZF	
			 1878 001 138 420 10 420GTZ	für / for: ANW Getr. / GBox: ZF Produktionsnummer / Production Number: 42231	(68) (52)
			 1878 002 955 420 10 420GTZ	für / for: AN Getr. / GBox: ZF Produktionsnummer / Production Number: 77311	(68) (52)
			 3151 000 515 KZIS-4	Getr. / GBox: ZF	
260-25 ANW 260-25 ANW	07.83 - 06.86 07.83 - 06.86	F8L413F	 3482 124 531 430 GMF430	Getr. / GBox: ZF	
			1882 316 035 ●# 420 GF420	Getr. / GBox: ZF	
			 1878 001 138 420 10 420GTZ	Getr. / GBox: ZF	
			 3151 000 515 KZIS-4	Getr. / GBox: ZF	
330-30 AN 330-30 AN 330-30 AN 330-30 ANW 330-30 ANW 330-30 ANW	05.86 - 09.90 05.86 - 09.90 05.86 - 09.90 05.86 - 09.90 05.86 - 09.90 05.86 - 09.90	BF8L513	 3482 124 533 # 420 GMF430	Getr. / GBox: ZF, Fuller	
			 1878 002 955 420 10 420GTZ	Getr. / GBox: ZF, Fuller	
			 3151 000 515 KZIS-4	Getr. / GBox: ZF, Fuller	
			 3400 700 312 430 10 MFZ430 430WGTZ 3482 083 113 1878 085 741 3151 000 144 KZISZ-5		
			 3400 042 031 420 10 MF420 420GTZ 3482 125 131 1878 002 955 1874 015 200	70351112 / 70351115 / 70351212 / 70351215 / 70351315 enthält Druckplattenbefestigungsschrauben / includes bolt for pressure plate mounting	(64)
330-30 N 330-30 N 330-30 N 330-30 N	10.87 - 12.90 01.91 - 12.92 10.87 - 12.90 10.87 - 12.92	8210.22X.575, 8210.22X.069	 3151 000 515 KZIS-4	70351112 / 70351115 / 70351212 / 70351215 / 70351315	
			 3482 085 033 420 MF420	70431112 / 70431115 enthält Druckplattenbefestigungsschrauben / includes bolt for pressure plate mounting	(64)
			 1878 002 955 420 10 420GTZ	70431112 / 70431115	
			 3151 196 031 KZIS-4	70431112 / 70431115	
330-30 NW 330-30 NW 330-30 NW 330-30 NW	10.87 - 12.90 01.91 - 12.92 10.87 - 12.90 10.87 - 12.92	8210.22X.575, 8210.22X.069	 3400 042 031 420 10 MF420 420GTZ 3482 125 131 1878 002 955 1874 015 200	enthält Druckplattenbefestigungsschrauben / includes bolt for pressure plate mounting	(64)

Sirius



Sirius K		F4L514	 1880 083 132 # 280 G280		
Sirius S		F4L514	 1880 083 132 # 280 G280		
			 1863 100 030 280 GR-3	mit Anlauftring / with thrust ring	(88)

IVECO

Stralis		02.02 -							
Stralis Euro 6		Cursor11		3400 700 366 3482 000 572 1878 004 132 3151 000 493	430 10 MFZ430 430WGTZ KZISZ-5	für / for: 480 PS Getr. / GBox: 16 S 2320 TD Getr. / GBox: 16 S 2520 TO Getr. / GBox: 12 AS 2330 TD Getr. / GBox: 12 AS 2330 TO Abgasnorm: Euro 6 / Exhaust Emission Norm: Euro 6 für Ausrückgabel mit Rollen / for release fork with rollers	(68) (4) (70)		
		Cursor13		3400 700 366 3482 000 572 1878 004 132 3151 000 493	430 10 MFZ430 430WGTZ KZISZ-5	für / for: 500 PS Getr. / GBox: 16 S 2320 TD Getr. / GBox: 16 S 2520 TO Getr. / GBox: 12 AS 2330 TO Getr. / GBox: 16 AS 2630 TO Abgasnorm: Euro 6 / Exhaust Emission Norm: Euro 6 für Ausrückgabel mit Rollen / for release fork with rollers	(68) (4) (70)		
				3400 700 366 3482 000 572 1878 004 132 3151 000 493	430 10 MFZ430 430WGTZ KZISZ-5	für / for: 560 PS Getr. / GBox: 16 S 2520 TO Getr. / GBox: 12 AS 2530 TO Abgasnorm: Euro 6 / Exhaust Emission Norm: Euro 6 für Ausrückgabel mit Rollen / for release fork with rollers	(68) (4) (70)		
AD 190S30, AD 190S31, AT 190S31	06.03-	F2BE0681		3400 084 031 3482 078 134 1878 032 032 3151 000 144	400 10 MFZ400 400WGTZ KZISZ-5	Getr. / GBox: 12AS-2301 DD MDPB1ME1 / MDPG14F1 / MDPG16E1 / MDPG16F1 / MDPG17E1 / MDPG17F1 / MDPG18E1 / MDPG18F1 / MDPG19E1 / MDPG19F1 / NDPB1ME1 / NDPB1MF1 / NDPB1MFA / NDPG16E1 / NDPG18E1 / NDPG18F1 / NDPG19E1 / NDPG19F1 / NDPG1ME1 / NDPG1MF1 / NDPB15E1 / NDPB15F1 / NDPB16F1 / NDPB17E1 / NDPB17F1 / NDPB18E1 / NDPB18F1 / NDPB19E1 / NDPB19F1 / MDPB13E1 / MDPB13F1 / MDPB14E1 / MDPB14F1 / MDPB15E1 / MDPB16E1 / MDPB16F1 / MDPB17E1 / MDPB17EA / MDPB17F1 / MDPB18E1 / MDPB18EA / MDPB18F1 / MDPB19E1 / MDPB19F1			
					3400 107 031 3482 078 134 1862 317 031 3151 000 144	400 10 MFZ400 400GVZ KZISZ-5	Getr. / GBox: 9S-109 MDPB1MB1 / MDPG14B1 / MDPG15B1 / MDPG16A1 / MDPG17A1 / MDPG17B1 / MDPG18A1 / MDPG18B1 / MDPG1MB1 / NDPA14B1 / NDPA15B1 / NDPB1MA1 / NDPB1MB1 / NDPG15A1 / NDPG17A1 / NDPG17B1 / NDPG18A1 / NDPG18B1 / NDPG19B1 / NDPG1MB1 / NDPA17A1 / NDPA17B1 / NDPA18A1 / NDPA18B1 / NDPA19A1 / NDPB15A1 / NDPB15B1 / NDPB16B1 / NDPB17A1 / NDPB17B1 / NDPB18A1 / NDPB18B1 / NDPB19A1 / NDPB19B1 / MDPA13A1 / MDPA13B1 / MDPA14A1 / MDPA14B1 / MDPA15A1 / MDPA15B1 / MDPA16A1 / MDPA16B1 / MDPA17A1 / MDPA17B1 / MDPA18A1 MDPA18B1 / MDPA19A1 / MDPA19B1 / MDPB13A1 / MDPB13B1 / MDPB14A1 / MDPB14B1 / MDPB15A1 / MDPB15B1 / MDPB16A1 / MDPB16B1 / MDPB17A1 / MDPB17B1 / MDPB18A1 / MDPB18B1 / MDPB19A1 / MDPB19B1 / MDPB1MA1		
					3400 107 031 3482 078 134 1862 317 031 3151 000 144	400 10 MFZ400 400GVZ KZISZ-5	Getr. / GBox: 16S-109 MDPB1MG1 / MDPB1MH1 / MDPG14G1 / MDPG14H1 / MDPG16G1 / MDPG17G1 / MDPG18G1 / MDPG19G1 / MDPG1MG1 / MDPG1MH1 / NDPA14G1 / NDPA15G1 / NDPB19H1 / NDPB1MG1 / NDPB1MH1 / NDPG15G1 / NDPG17G1 / NDPG18G1 / NDPG18H1 / NDPG19G1 / NDPG1MG1 / NDPG1MH1 / NDPA16G1 / NDPA17G1 / NDPA18H1 / NDPB14G1 / NDPB15G1 / NDPB16G1 / NDPB17G1 / NDPB17H1 / NDPB18G1 / NDPB18H1 / NDPB19G1 / MDPA13G1 / MDPA13H1 / MDPA14G1 / MDPA14H1 / MDPA15G1 / MDPA15H1 / MDPA16G1 / MDPA16H1 / MDPA17G1 / MDPA17H1 / MDPA18G1 / MDPB13G1 MDPB13H1 / MDPB14G1 / MDPB14H1 / MDPB15G1 / MDPB15H1 / MDPB16G1 / MDPB17G1 / MDPB17H1 / MDPB18G1 / MDPB18H1 / MDPB19G1 / MDPB19H1		
AD 190S31, AT 190S31	04.04-	F2BE3681C		3400 700 377 3482 000 628 1878 004 581 3151 000 651	430 10 MF430 430WGTZ KZIS-4	QAAB13C1 / QAAB13C3 / QAAA13C1 / TAAA19C1 / TAAB19C1 / TAAB16C3 / TAAB17C3 / TAAB18C3 / TAAB19C3 / TAAA17C3			







		CODE				
--	--	------	--	---	---	---

IVECO

Stralis		02.02 -				
AD 190S31, AT 190S31 AD 190S33, AT 190S33 AD 260S31, AT 260S31 AD 260S31, AT 260S31 AD 260S33, AT 260S33 AD 260S33, AT 260S33	01.13- 01.13- 01.13- 01.13- 01.13- 01.13-	Cursor9	 3400 700 365 ⊗ 3482 000 573 ⊗ 1878 004 133 ⬢ 3151 000 493	430 10 MFZ430 430WGTZ KZISZ-5	Getr. / GBox: 12 AS 1420 TD Getr. / GBox: 12 AS 1930 TD Getr. / GBox: 12 AS 2330 TO Getr. / GBox: 16 S 1620 TD Abgasnorm: Euro 6 / Exhaust Emission Norm: Euro 6 für Ausrückgabel mit Rollen / for release fork with rollers	(4) (70)
			3400 700 377 ⊗ 3482 000 628 ⊗ 1878 004 581 ⬢ 3151 000 651	430 10 MF430 430WGTZ KZIS-4	Getr. / GBox: 9 S 1310TO Abgasnorm: Euro 6 / Exhaust Emission Norm: Euro 6	(4)
AD 190S33, AT 190S33	12.06-	F2BE3681	 3400 700 365 ⊗ 3482 000 573 ⊗ 1878 004 133 ⬢ 3151 000 493	430 10 MFZ430 430WGTZ KZISZ-5	Getr. / GBox: 12AS-1420 TD TABB1MBA für Ausrückgabel mit Rollen / for release fork with rollers	(70)
			3400 700 365 ⊗ 3482 000 573 ⊗ 1878 004 133 ⬢ 3151 000 493	430 10 MFZ430 430WGTZ KZISZ-5	Getr. / GBox: 12AS-1930 TD QABB17E1 / TABB14E1 / TABB18E1 / TABCU8E1 für Ausrückgabel mit Rollen / for release fork with rollers	(70)
			3482 000 573	430 MFZ430	Getr. / GBox: 16S-1620 TD QABA13A1 / QABA14A1 / QABB13A1 / QABB14A1 / QABB18A1 / QABCD3A1 / QABCU8A1 / TABB19A1 / TABCD8A1	
			3482 000 573	430 MFZ430	Getr. / GBox: 12AS-1420 TD TABB1MBA	
			3482 000 573	430 MFZ430	Getr. / GBox: 12AS-1930 TD QABA14E1 / QABB17E1 / QABB18E1 / QABCD8E1 / TABB14E1 / TABB18E1 / TABCU8E1	
			1878 004 133	430 10 430WGTZ	Getr. / GBox: 12AS-1930 TD QABA14E1 / QABB17E1 / QABB18E1 / QABCD8E1 / TABB14E1 / TABB18E1 / TABCU8E1	
			1878 004 133	430 10 430WGTZ	Getr. / GBox: 12AS-1420 TD TABB1MBA	
			1878 004 133	430 10 430WGTZ	Getr. / GBox: 16S-1620 TD QABA13A1 / QABA14A1 / QABB13A1 / QABB14A1 / QABB18A1 / QABCD3A1 / QABCU8A1 / TABB19A1 / TABCD8A1	
			3151 000 144	KZISZ-5	Getr. / GBox: 16S-1620 TD QABA13A1 / QABA14A1 / QABB13A1 / QABB14A1 / QABB18A1 / QABCD3A1 / QABCU8A1 / TABB19A1 / TABCD8A1	
			3151 000 144	KZISZ-5	Getr. / GBox: 12AS-1420 TD TABB1MBA	
			3151 000 144	KZISZ-5	Getr. / GBox: 12AS-1930 TD QABA14E1 / QABB17E1 / QABB18E1 / QABCD8E1 / TABB14E1 / TABB18E1 / TABCU8E1	
AD 190S33, AT 190S33	05.07-	F2BE3681B	 3400 700 365 ⊗ 3482 000 573 ⊗ 1878 004 133 ⬢ 3151 000 493	430 10 MFZ430 430WGTZ KZISZ-5	QABB13E3 / QABB19E3 / QABCD7E3 für Ausrückgabel mit Rollen / for release fork with rollers	(70)
			3400 700 378 ⊗ 3482 000 573 ⊗ 1878 004 133 ⬢ 3151 000 144	430 10 MFZ430 430WGTZ KZISZ-5	QABA13A3 / QABA14A3 / QABA17A3 / QABA19A3 / QABB14A3 / QABB17A3 / QABB18A3 / QABB19A3	















		CODE				
--	--	------	--	---	---	---

IVECO

Stralis		02.02 -				
AD 190S35, AT 190S35, AD 190S36, AT 190S36	06.03-	F2BE0681	 3400 084 031 3482 078 134 1878 032 032 3151 000 144	400 10 MFZ400 400WGTZ KZISZ-5	Getr. / GBox: 12AS-2301 DD NDRB14E1 / NDRB14F1 / NDRB16E1 / NDRB17E1 / / NDRB17F1 / NDRB18E1 / NDRB18F1 / NDRB19E1 / NDRB19EA / NDRB19F1 / NDRB19FA / NDRB1ME1 / NDRB1MF1 / MDRB14E1 / MDRB14F1 / MDRB15E1 / MDRB16E1 / MDRB16F1 / MDRB17E1 / MDRB17F1 / MDRB18E1 / MDRB19E1 / MDRB19F1 / MDRB1ME1 / MDRG15EA / MDRG15F1 / MDRG16E1 / MDRG17E1 / MDRG17F1 / MDRG18E1 / MDRG18F1 / MDRG19F1 / MDRG1ME1 / MDRG1MEA / MDRG1MF1 / NDRG16E1 / NDRG16F1 / NDRG17E1 / NDRG18E1 / NDRG18F1 / NDRG19E1 / NDRG19F1 / NDRG1ME1 / NDRG1MF1	
			3400 084 031 3482 078 134 1878 032 032 3151 000 144	400 10 MFZ400 400WGTZ KZISZ-5	Getr. / GBox: 16S-151 NDRA17B1 / NDRA18B1 / NDRA19A1 / NDRA19B1 / NDRB14A1 / NDRB14B1 / NDRB15B1 / NDRB16A1 / NDRB16B1 / NDRB17A1 / NDRB17B1 / NDRB18A1 / NDRB19B1 / NDRB1MA1 / NDRB1MB1 / NDRG14A1 / NDRG16A1 / NDRG16B1 / MDRA13A1 / MDRA13B1 / MDRA14A1 / MDRA14B1 / MDRA15A1 / MDRA15B1 / MDRA16A1 / MDRA16B1 / MDRA17A1 / MDRA17B1 / MDRA18A1 / MDRA18B1 / MDRA19A1 / MDRA19B1 / MDRB14A1 / MDRB14B1 / MDRB15A1 / MDRB15BA / MDRB16A1 / MDRB16B1 / MDRB17A1 / MDRB17B1 / MDRB18A1 / MDRB18B1 / MDRB19A1 / MDRB19B1 / MDRB1MA1 MDRG14A1 / MDRG14B1 / MDRG15A1 / MDRG16A1 / MDRG16B1 / MDRG17B1 / MDRG18A1 / MDRG18B1 / MDRG19A1 / MDRG1MA1 / NDRG17A1 / NDRG17B1 / NDRG18A1 / NDRG18B1 / NDRG19A1 / NDRG19B1 / NDRG1MA1 / NDRG1MB1	
	F2BE3681		 3400 700 365 3482 000 573 1878 004 133 3151 000 493	430 10 MFZ430 430WGTZ KZISZ-5	Getr. / GBox: 12AS-1930TD QACA13B1 / QACB13B1 / QACB17B1 / QACB18B1 / QACCD8B1 / TACB18B1 / TACB19B1 / TACCD8B1 / TACCD9B1 für Ausrückgabel mit Rollen / for release fork with rollers (70)	
			3400 700 378 3482 000 573 1878 004 133 3151 000 144	430 10 MFZ430 430WGTZ KZISZ-5	Getr. / GBox: 16S-1620TD QACA13A1 / QACA16A1 / QACA18A1 / QACA19A1 / QACB13A1 / QACB16A1 / QACB17A1 / QACCD8A1 / QACCDMA1 / TACA19A1 / TACB16A1 / TACB18A1 / TACB19A1 / TACCD7A1 / TACCD8A1	
	F2BE3681A, F2BE0681A		 3400 700 365 3482 000 573 1878 004 133 3151 000 493	430 10 MFZ430 430WGTZ KZISZ-5	TACB1MB1 / TACCU8B1 für Ausrückgabel mit Rollen / for release fork with rollers (70)	
			3400 700 378 3482 000 573 1878 004 133 3151 000 144	430 10 MFZ430 430WGTZ KZISZ-5	TACB1MB1 / TACCU8B1	
AD 190S36, AT 190S36	05.07-	F2BE3681A	 3400 700 378 3482 000 573 1878 004 133 3151 000 144	430 10 MFZ430 430WGTZ KZISZ-5	TACA17A3 / TACB16A3 / TACB17A3 / TACB18A3 / TACB19A3 / TACB1MA3 / TACCD9A3 / TACCDMA3 / TACCU8A3	
			3400 700 365 3482 000 573 1878 004 133 3151 000 493	430 10 MFZ430 430WGTZ KZISZ-5	TACB15B3 / TACB18B3 / TACB19B3 / TACB1MB3 / TACCD7B3 / TACCD8B3 / TACCD9B3 / TACCU8B3 für Ausrückgabel mit Rollen / for release fork with rollers (70)	
AD 190S36, AT 190S36 AD 190S40, AT 190S40 AD 260S36, AT 260S36 AD 260S36, AT 260S36 AD 260S40, AT 260S40	01.13- 01.13- 01.13- 01.13- 01.13-	Cursor9	 3400 700 365 3482 000 573 1878 004 133 3151 000 493	430 10 MFZ430 430WGTZ KZISZ-5	Getr. / GBox: 16 S 1620 TD Getr. / GBox: 12 AS 1420 TD Getr. / GBox: 12 AS 1930 TD Getr. / GBox: 12 AS 2330 TO Abgasnorm: Euro 6 / Exhaust Emission Norm: Euro 6 für Ausrückgabel mit Rollen / for release fork with rollers (4) (70)	
AD 190S40, AT 190S40	03.03-	F3AE0681	 3400 117 801 3482 083 032 1878 085 741 3151 000 144	430 10 MFZ430 430WGTZ KZISZ-5	Getr. / GBox: 16S-181 MLLG1MA1 / MLLA14A1 / MLLA15A1 / MLLA15B1 / MLLA16B1 / MLLA17A1 / MLLB15A1 / MLLB16A1 / MLLB17A1 / MLLB18A1 / MLLB1MA1 / MLLG15A1 / NLLA19A1 / NLLB15A1 / NLLB17A1 / NLLB18A1 / NLLB18B1 / NLLB19A1 / NLLB1MA1 / NLLCN8B1 / NLLCNLA1 / NLLCNLB1 / NLLG15A1 / NLLG17A1 / NLLG18A1 / NLLG19A1 / NLLG1MA1 / NLLG1MB1	
			3400 117 801	430 10	Getr. / GBox: 12AS-2301DD MLLG1ME1 / MLLB15E1 / MLLB17E1 / MLLB18E1 / MLLB18F1 / MLLB1ME1 / MLLG15E1 / MLLG16E1 /	





















		CODE				
--	--	------	--	---	---	---

IVECO





Stralis		02.02 -								
AD 190S42, AT 190S42, AS 190S42	07.06-	F3AE3681		3400 700 365 ⊗ 3482 000 573 ⊗ 1878 004 133 ⊙ 3151 000 493	430 10 MFZ430 430WGTZ KZISZ-5	Getr. / GBox: 12AS-1930TD TFDB16B1 / TFDCD7B1 / TFDCNLB1 für Ausrückgabel mit Rollen / for release fork with rollers	(70)			
				3482 000 573	430 MFZ430	Getr. / GBox: 12AS-1930TD TFDB13B1 / TFDB16B1 / TFDCD7B1 / TFDCNLB1 / TFDCU8B1				
				1878 004 133	430 10 430WGTZ	Getr. / GBox: 12AS-1930TD TFDB13B1 / TFDB16B1 / TFDCD7B1 / TFDCNLB1 / TFDCU8B1				
				3151 000 144	KZISZ-5	Getr. / GBox: 12AS-1930TD TFDB13B1 / TFDB16B1 / TFDCD7B1 / TFDCNLB1 / TFDCU8B1				
		F3AE3681		3400 700 395 ⊗ 3482 000 573 ⊗ 1878 004 581 ⊙ 3151 000 493	430 10 MFZ430 430WGTZ KZISZ-5	Getr. / GBox: 16S-1920TD TFDB1MA3 / TFDB18A3 / TFDCDMA3 / TFDCD9A3 / TFDCN8A3 / TFDCU8A3 / ZADCL8A3 / ZADCU8A3				
AD 190S42, AT 190S42, AS 190S42	01.13-	Cursor11		3400 700 366 ⊗ 3482 000 572 ⊗ 1878 004 132 ⊙ 3151 000 493	430 10 MFZ430 430WGTZ KZISZ-5	Getr. / GBox: 16 S 1920 TD				
AD 260S42, AT 260S42	01.13-					Getr. / GBox: 16 S 2220 TO				
AD 260S42, AT 260S42, AS 260S42	01.13-					Getr. / GBox: 12 AS 1930 TD				
AD 440S42, AT 440S42, AS 440S42	01.13-					Getr. / GBox: 12 AS 2330 TD				
						Abgasnorm: Euro 6 / Exhaust Emission Norm: Euro 6 für Ausrückgabel mit Rollen / for release fork with rollers	(4) (70)			
AD 190S43, AT 190S43	06.03-	F3AE0681		3400 117 801 ⊗ 3482 083 032 ⊗ 1878 085 741 ⊙ 3151 000 144	430 10 MFZ430 430WGTZ KZISZ-5	Getr. / GBox: 16S-181 MLKA14A1 / MLKA14B1 / MLKB15A1 / MLKB16A1 / MLKB17A1 / MLKB18A1 / MLKG17A1 / MLKG18A1 / MLKG19A1 / NLKA17A1 / NLKA17B1 / NLKB15A1 / NLKB15B1 / NLKB16A1 / NLKB17A1 / NLKB18A1 / NLKB18B1 / NLKB19A1 / NLKB1MA1 / NLKCN8A1 / NLKCN8B1 / NLKCNLA1 / NLKCNLB1 / NLKG15A1 / NLKG16A1 / NLKG17A1 / NLKG18A1 / NLKG19A1				
						3400 117 801 ⊗ 3482 083 032 ⊗ 1878 085 741 ⊙ 3151 000 144	430 10 MFZ430 430WGTZ KZISZ-5	Getr. / GBox: 12AS-2301DD MLKB15E1 / MLKB15EA / MLKB17E1 / MLKB18E1 / MLKB1ME1 / MLKG15E1 / MLKG16E1 / MLKG17E1 / MLKG18E1 / NLKB15E1 / NLKB15F1 / NLKB16E1 / NLKB17E1 / NLKB18E1 / NLKB18EA / NLKB18F1 / NLKB19E1 / NLKB19EA / NLKCN8E1 / NLKCNLE1 / NLKCNLEA / NLKCNLF1 / NLKG15E1 / NLKG17E1 / NLKG18E1 / NLKG1ME1		
AD 190S45, AT 190S45	12.06-	F3AE3681		3400 700 365 ⊗ 3482 000 573 ⊗ 1878 004 133 ⊙ 3151 000 493	430 10 MFZ430 430WGTZ KZISZ-5	Getr. / GBox: 12AS-2330TD QFECU8B1 / TFECDD7B1 / TFECNLB1 für Ausrückgabel mit Rollen / for release fork with rollers	(70)			
							3482 000 573	430 MFZ430	Getr. / GBox: 12AS-2330TD QFECU8B1 / TFEB18BA / TFECDD5B1 / TFECDD7B1 / TFECNLB1 / TFECU8B1	
							1878 004 133	430 10 430WGTZ	Getr. / GBox: 12AS-2330TD QFECU8B1 / TFEB18BA / TFECDD5B1 / TFECDD7B1 / TFECNLB1 / TFECU8B1	
							3151 000 144	KZISZ-5	Getr. / GBox: 12AS-2330TD QFECU8B1 / TFEB18BA / TFECDD5B1 / TFECDD7B1 / TFECNLB1 / TFECU8B1	
		F3AE3681A		3400 700 462 ■	430 10	Getr. / GBox: ZF16S-1920TD QFEA13A3 / QFEB138A3 / QFEB16A3 / QFEB18A3 / QFECU8A3 / QFEA14A1 / QFEB15A1 / QFECDD8A1 / ZAEB17A3 / ZAEB18A3 / ZAEB1LA3 / ZAEB18A3 / ZAEB17A3 / ZAEB15A1 / ZAEB17A1 / ZAEB1LA1 / ZAEBLLA1 / ZAECU8A1 / TFECU8A3 / TFEB19A3 / TFECDD8A3 / TFECN8A3 / TFECNLA3 / TFEB17A1 / TFEB18A1 / TFECDD8A1 / TFECDDN8A1 / TFECNLA1 / TFECN8A1 Nabenprofil / Hub Profile: 41,25x52,1x10Z	(46)			
		F3AE3681		3400 700 395 ⊗ 3482 000 573 ⊗ 1878 004 581 ⊙ 3151 000 493	430 10 MFZ430 430WGTZ KZISZ-5	Getr. / GBox: 16S-2220TD TFEA17A3 / TFEB14A3 / TFEB16A3 / TFECDD5A3 / TFECDD7A3 / TFECDD8A3 / TFECNLA3 / TFECU8A3				
AD 190S46, AT 190S46, AS 190S46	01.13-	Cursor13		3400 700 366 ⊗ 3482 000 572 ⊗ 1878 004 132 ⊙ 3151 000 493	430 10 MFZ430 430WGTZ KZISZ-5	Getr. / GBox: 12 AS 2330 TD Getr. / GBox: 12 AS 2330 TO Getr. / GBox: 16 AS 2630 TO Abgasnorm: Euro 6 / Exhaust Emission Norm: Euro 6 für Ausrückgabel mit Rollen / for release fork with rollers	(4) (70)			

		CODE				
--	--	------	--	---	---	---











IVECO

Stralis		02.02 -					
AD 190S46, AT 190S46, AS 190S46	01.13-	Cursor11		3400 700 366  3482 000 572  1878 004 132  3151 000 493	430 10 MFZ430 430WGTZ KZISZ-5	Getr. / GBox: 16 S 2220 TD Getr. / GBox: 16 S 2220 TO Getr. / GBox: 12 AS 2330 TD Getr. / GBox: 12 AS 2330 TO Abgasnorm: Euro 6 / Exhaust Emission Norm: Euro 6 für Ausrückgabel mit Rollen / for release fork with rollers	(4) (70)
AD 260S46, AT 260S46, AS 260S46	01.13-						
AD 260S46, AT 260S46, AS 260S46	01.13-						
AD 440S46, AT 440S46, AS 440S46	01.13-						
AD 440S46, AT 440S46, AS 440S46	01.13-						
AT 440S46	01.13-						
260S35 AD	02.02-	F2BE0681		3400 084 031  3482 078 134  1878 032 032  3151 000 144	400 10 MFZ400 400WGTZ KZISZ-5	Getr. / GBox: 6S-151 Getr. / GBox: 12AS 2301DD	
260S35 AD				3496 006 000		Getr. / GBox: 6S-151 Getr. / GBox: 12AS 2301DD langer Bügel / long handle	(86)
260S35 AT							
AD 260S42, AT 260S42	12.06-	F3AE3681B		3400 700 462 ■	430 10	Getr. / GBox: ZF16S-1920TD ZDDCL6A1 / ZDDCU5A1 / ZDDCU6A1 / ZDDE16A1 / ZDDFL7A1 / ZDDE18A1 / ZDDE19A1 / ZDDFU5A1 / ZCDB19A1 / ZDDFU6A1 / ZDDFU9A1 / ZDDB15A1 / ZDDB16A1 / QKDFD4A1 / QKDFD5A1 / QKDFD6A1 / QKDFD7A1 / QKDFD8A1 / QKDFU4A1 / QKDFU5A1 / QKDFU6A1 / QKDE15A1 / QKDE17A1 / QKDE17AA / QKDE19A1 / QKDE14A1 / QHDA14A1 / QHDB14A1 / QHDB16A1 / QHDB17A1 / QKDB14A1 / QKDB15A1 / QKDB16A1 / QKDCU6A1 / QKDE16A1 / THDB15A1 / THDB18A1 / THDB19A1 / TKDB14A1 / TKDB15A1 / TKDB16A1 / TKDB17A1 / TKDB18A1 / TKDB19A1 / TKDCD4A1 TKDCU6A1 / TKDE18A1 / TKDE14A1 / TKDE15A1 / TKDE16A1 / TKDE17A1 / TKDE13A1 / TKFD4A1 / TKFD5A1 / TKFD6A1 / TKFD7A1 / TKFD8A1 / TKFD9A1 / TKDFU5A1 / TKDFU6A1 / TKDFU8A1 / TKDFU9A1 / THDB14A1 Nabenprofil / Hub Profile: 41,25x52,1x10Z	(46)
		F3AE3681		3400 700 395  3482 000 573  1878 004 581  3151 000 493	430 10 MFZ430 430WGTZ KZISZ-5	Getr. / GBox: 16S-1920TD QKDB16A3 / QKDB17A3 / QKDB18A3 / QKDCD8A3 / QKDCU6A3 / QKDE13A3 / QKDE16A3 / QKDE18A3 / QKDE19A3 / QKDFD3A3 / QKDFD4A3 / QKDFD5A3 / QKDFD7A3 / QKDFD9A3 / QKDFU4A3 / QKDFU5A3 / QKDFU7A3 / ZCDB17A3 / ZDDCU6A3 / ZDDE16A3 / ZDDE18A3 / ZDDE19A3 / ZDDFU4A3 / ZDDFU6A3 / ZDDFU9A3	
AD 260S42, AT 260S42, AS 260S42	05.07-	F3AE3681B		3400 700 462 ■	430 10	Getr. / GBox: ZF16S-1920TD THDB14A3 / THDB15A3 / THDB17A3 / THDB18A3 / TKDB16A3 / TKDB17A3 / TKDB19A3 / TKDCU6A3 / TKDE18A3 / TKDFU9A3 / TKDE19A3 / TKDFD9A3 / TKDE17A3 / TKDE16A3 / TKDFD4A3 / TKDFD5A3 / TKDFD6A3 / TKDFD8A3 / TKDE14A3 / TKDE15A3 / TKDFU5A3 / TKDFU8A3 / ZDDCU6A3 / ZDDFL6A3 / ZDDE18A3 / ZDDE14A3 / ZDDE15A3 / ZDDE16A3 / ZDDE19A3 / ZDDFU6A3 / ZDDFU8A3 / ZDDFU9A3 / ZDDE17A3 / ZDDB15A3 / ZDDB16A3 / ZDDB17A3 / TUPB15A3 / QKDFD5A3 / QKDFD6A3 / QKDFU5A3 / QKDFU9A3 / QKDE14A3 / QKDE17A3 / QKDE18A3 / QKDE13A3 QHDA15A3 / QHDA16A3 / QHDB14A3 / QHDB15A3 / QHDB17A3 / QHDB18A3 / QKDB14A3 / QKDB15A3 / QKDB17A3 / QKDCU6A3 / QKDE15A3 / QKDE16A3 Nabenprofil / Hub Profile: 41,25x52,1x10Z	(46)
		F3AE3681		3400 700 395  3482 000 573  1878 004 581  3151 000 493	430 10 MFZ430 430WGTZ KZISZ-5	Getr. / GBox: 16S-1920TD QKDB16A3 / QKDB17A3 / QKDB18A3 / QKDCD8A3 / QKDCU6A3 / QKDE13A3 / QKDE16A3 / QKDE18A3 / QKDE19A3 / QKDFD3A3 / QKDFD4A3 / QKDFD5A3 / QKDFD7A3 / QKDFD9A3 / QKDFU4A3 / QKDFU5A3 / QKDFU7A3 / ZCDB17A3 / ZDDCU6A3 / ZDDE16A3 / ZDDE18A3 / ZDDE19A3 / ZDDFU4A3 / ZDDFU6A3 / ZDDFU9A3	
AD 260S43, AT 260S43	06.03-	F3AE0681D		3400 700 462 ■	430 10	Getr. / GBox: ZF16S-1920TD QUQB14A3 / ZUQCL6A3 / TUQB15A3	



















































IVECO

Stralis		02.02 -			
AD 260S45, AT 260S45	12.06-	F3AE3681A	 3400 700 462 ■ 430 10	Getr. / GBox: ZF16S-1920TD THEB17A1 / THEB18A1 / TKEB16A1 / TKEB17A1 / TKEB19A1 / TKECD7A1 / TKECU6A1 / TKEE13A1 / TKEE14A1 / TKEFD8A1 / TKEFD9A1 / TKEFU4A1 / TKEFU5A1 / TKEFU6A1 / TKEFU7A1 / TKEFU8A1 / TKEFU9A1 / TKEE18A1 / TKEE19A1 / TKEFD4A1 / TKEFD5A1 / TKEFD6A1 ZDEFU7A1 / ZDEFU8A1 / ZDEFU9A1 / ZDEE15A1 / ZDEB16A1 / ZDEB17A1 / ZDECL6A1 / ZDECL7A1 / ZDECU5A1 / ZDECU6A1 / ZDEE14A1 / ZCEB17A1 / ZDEE16A1 / ZDEE17A1 / ZDEE18A1 / ZDEE19A1 / ZDEFL7A1 / ZDEFU4A1 / ZDEFU5A1 / ZDEFU6A1 / QKEE16A1 / QKEE17A1 / QKEE18A1 / QKEE19A1 / QKEFD3A1 / QKEFD4A1 / QKEFD5A1 / QKEFD8A1 / QKEFU4A1 / QKEFU5A1 / QKEE14A1 / QKEB15A1 / QKEB16A1 / QKEE13A1 / QKEE15A1 / QHEB16A1 / QHEB17A1 / QKEFU6A1 / QKEFU8A1 / TKEE15A1 / TKEE16A1 / TKEE17A1 / THEA18A1 / THEB14A1 / THEB16A1 Nabenprofil / Hub Profile: 41,25x52,1x10Z (46)	
		F3AE3681	 3400 700 395 ⊕ 3482 000 573 ⊕ 1878 004 581 ⊕ 3151 000 493	430 10 MFZ430 430WGTZ KZISZ-5	Getr. / GBox: 16S-2220TD QKEB16A3 / QKEE13AC / QKEE13A3 / QKEE14AC / QKEE14A3 / QKEE16A3 / QKEE17A3 / QKEE18A3 / QKEFD3A3 / QKEFD4A3 / QKEFD5A3 / QKEFD6A3 / QKEFD8A3 / QKEFU4A3 / QKEFU5A3 / QKEFU6A3 / TKEE15A3 / TKEE16A3 / TKEE17A3 / TKEE19A3 / TKEFD4A3 / TKEFD5A3 / TKEFD8A3 / TKEFU4A3 / TKEFU5A3 / TKEFU6A3 / TKEFU9A3 / ZDECL5A3 / ZDECL6A3 / ZDECU5A3 / ZDECU6A3 / ZDEE14A3 / ZDEE15A3 / ZDEE16A3 / ZDEE18A3 / ZDEE19A3 / ZDEFU4A3 / ZDEFU6A3 / ZDEFU8A3 / ZDEFU9A3
			3400 700 395 ⊕ 3482 000 573 ⊕ 1878 004 581 ⊕ 3151 000 493	430 10 MFZ430 430WGTZ KZISZ-5	Getr. / GBox: 16S-1920TD ZDEFU5A3
AD 260S45, AT 260S45, AS 260S45	05.07-	F3AE3681A	 3400 700 462 ■ 430 10	Getr. / GBox: ZF16S-1920TD TKEE14A3 / TKEE15A3 / TKEE16A3 / THEB16A3 / TKEB13A3 / TKEB14A3 / TKEB16A3 / TKEB17A3 / TKEB18A3 / TKECU6A3 / TKEE13A3 / TKEFD9A3 / TKEFU4A3 / TKEFU5A3 / TKEFU6A3 / TKEFU7A3 / TKEE17A3 / TKEE18A3 / TKEE19A3 / TKEFD4A3 / TKEFD6A3 / TKEFD7A3 / ZDEFU7A3 / ZDEFU8A3 / ZDEFU9A3 / ZDEE14A3 / ZDEB14A3 / ZDEB16A3 / ZDEB17A3 / ZDECL5A3 / ZDECL6A3 / ZDECL7A3 / ZDECU4A3 / ZDECU5A3 / ZDECU6A3 / ZCEB19A3 / ZDEE15A3 / ZDEE16A3 / ZDEE17A3 / ZDEE18A3 / ZDEE19A3 / ZDEFU4A3 / ZDEFU5A3 / ZDEFU6A3 / QKEE16A3 QKEE16AC / QKEE176A3 / QKEE18A3 / QKEE19A3 / QKEFD3A3 / QKEFD4A3 / QKEFD6A3 / QKEFU5A3 / QKEE13A3 / QKEB14A3 / QKEB15A3 / QKEB16A3 / QKEE14A3 / QKEE15A3 Nabenprofil / Hub Profile: 41,25x52,1x10Z (46)	
		F3AE3681	 3400 700 395 ⊕ 3482 000 573 ⊕ 1878 004 581 ⊕ 3151 000 493	430 10 MFZ430 430WGTZ KZISZ-5	Getr. / GBox: 16S-2220TD QKEB16A3 / QKEE13AC / QKEE13A3 / QKEE14AC / QKEE14A3 / QKEE16A3 / QKEE17A3 / QKEE18A3 / QKEFD3A3 / QKEFD4A3 / QKEFD6A3 / QKEFD8A3 / QKEFU4A3 / QKEFU5A3 / QKEFU6A3 / TKEE15A3 / TKEE16A3 / TKEE17A3 / TKEE19A3 / TKEFD4A3 / TKEFD5A3 / TKEFD8A3 / TKEFU4A3 / TKEFU5A3 / TKEFU6A3 / TKEFU9A3 / ZDECL5A3 / ZDECL6A3 / ZDECU5A3 / ZDECU6A3 / ZDEE14A3 / ZDEE15A3 / ZDEE16A3 / ZDEE18A3 / ZDEE19A3 / ZDEFU4A3 / ZDEFU6A3 / ZDEFU8A3 / ZDEFU9A3
			3400 700 395 ⊕ 3482 000 573 ⊕ 1878 004 581 ⊕ 3151 000 493	430 10 MFZ430 430WGTZ KZISZ-5	Getr. / GBox: 16S-1920TD ZDEFU5A3

IVECO





























Stralis		02.02 -					
AD 440S42, AT 440S42 AS 440S42, AT 440S42	04.06 -	F3AE3681D, F3AE3681B		3400 700 462 ■	430 10	Getr. / GBox: ZF16S-1920TD QGDB21A1 / QGDB23A1 / QGDE21A2 / ZEDB21A1 / ZBDB21A1 / ZBDCT1A1 / TGDB21A1 / TMDDB21A1 / TGDB23A1 / TGDBH1AA / TGDBH3A1 / TGDCM3A1 / TGDCM3A3 / TGDE21A2 / TGDE23A2 / TMDDB21A3 / TGDB21A3 / TGDB23A3 / TGDBH3A3 / TGDCM3A3 / TGDCM3A3 / TGDCM3A3 / TGDE21A4 / ZEDB21A3 / ZBDB23A3 / ZBDB21A3 / ZBDBH3A3 / ZBDCT1A3 / QGDB21A3 / QGDB23A3 / QGDE21A4 / QGDE23A4 Nabenprofil / Hub Profile: 41,25x52,1x10Z	(46)
	12.06 -	F3AE3681		3400 700 395 ⊙ 3482 000 573 ⊙ 1878 004 581 ⊙ 3151 000 493	430 10 MFZ430 430WGTZ KZISZ-5	Getr. / GBox: 16S-1920TD TGDBH3A3 / TGDB21AC / TGDB21A3 / TGDB23A3 / TGDCM3A3	
AD 440S43, AT 440S43 AD 440S43, AT 440S43 AT 440S43 AT 440S43	06.03 - 06.03 - 06.03 - 06.03 -	F3AE0681D		3400 700 462 ■	430 10	Getr. / GBox: ZF16S-1920TD ZTQB23A3 / TSQB21A3 / TSQB23A3 / TSQBH3A3 / TSQCT1A3 / TSQE21A4 / TSQE23A4 Nabenprofil / Hub Profile: 41,25x52,1x10Z	(46)
AD 440S45, AT 440S45 AS 440S45	12.06 - 12.06 -	F3AE3681A		3400 700 462 ■	430 10	Getr. / GBox: ZF16S-1920TD TMEB21A3 / TMEB21AC / TGECT1A3 / TGEB21A3 / TGECM3A3A / TJEBH2A3 / TJEBH2AC / TGEB23A3 / TGEB23AC / TGEBH3A3 / TGEE21A4 / ZBEB23A3 / ZBEB24AC / ZEEB21A3 / ZEEB21AC / ZBECT1A3 / ZBEB21A3 / ZBEBH1A3 / ZBEBH3A3 / QGEB21A3 / QGEB23A3 / QGEBH1A3 / QGEE21A4 / TMEB21A1 / TMEB21AA / TGECT1A1 / TGEB21A1 / TJEBH1A1 / TJEBH2AA / TGEB23AA / TGEB23A1 / TGEBH3A1 / TGECM3A1 / TGEE21A2 / TGEE23A2 / ZBEB21A1 / ZBEB23AA / ZEEB21A1 / ZEEB21AA / ZBEE23A2 / ZBEB23A1 / ZBEBH3A1 / ZBECT1A1 / QGEB23A1 / QGEB21A1 / QGEE21A2 / QGEE23A2 Nabenprofil / Hub Profile: 41,25x52,1x10Z	(46)
		F3AE3681		3400 700 395 ⊙ 3482 000 573 ⊙ 1878 004 581 ⊙ 3151 000 493	430 10 MFZ430 430WGTZ KZISZ-5	Getr. / GBox: 16S-2220TO TGEE21A4 / TGEE23A4	
				3400 700 395 ⊙ 3482 000 573 ⊙ 1878 004 581 ⊙ 3151 000 493	430 10 MFZ430 430WGTZ KZISZ-5	Getr. / GBox: 16S-2220TD TGEBH3A3 / TGEB21A3 / TGEB23A3 / TGECM3A3 / TGECT1A3 / TMEB21A3	
AD 440S48, AT 440S48, AS 440S48 AD 440S48, AT 440S48, AS 440S48 AT 440S48	01.13 - 01.13 - 01.13 -	Cursor13		3400 700 366 ⊙ 3482 000 572 ⊙ 1878 004 132 ⊙ 3151 000 493	430 10 MFZ430 430WGTZ KZISZ-5	Getr. / GBox: 16 S 2220 TO Abgasnorm: Euro 6 / Exhaust Emission Norm: Euro 6 für Ausrückgabel mit Rollen / for release fork with rollers	(4) (70)
AS 190S40	02.02 -	F3AE0681		3400 117 801 ⊙ 3482 083 032 ⊙ 1878 085 741 ⊙ 3151 000 144	430 10 MFZ430 430WGTZ KZISZ-5	Getr. / GBox: 16S-181 LDLB15A1 / LDLB17A1 / LDLB18A1 / LDLB19A1 / LDLC18A1 / LDLC17A1 / LDLC18A1	
				3400 117 801 ⊙ 3482 083 032 ⊙ 1878 085 741 ⊙ 3151 000 144	430 10 MFZ430 430WGTZ KZISZ-5	Getr. / GBox: 12AS-2301DD LDLB15E1 / LDLB17E1 / LDLB18E1 / LDLB19E1 / LDLC18E1 / LDLC17E1 / LDLC18E1	
AS 190S45	12.06 -	F3AE3681		3400 700 395 ⊙ 3482 000 573 ⊙ 1878 004 581 ⊙ 3151 000 493	430 10 MFZ430 430WGTZ KZISZ-5	Getr. / GBox: 16S-2220TD ZAEB17A3 / ZAECU8A3	
AS 190S48	02.02 -	F3BE0681		3400 117 801 ⊙ 3482 083 032 ⊙ 1878 085 741 ⊙ 3151 000 144	430 10 MFZ430 430WGTZ KZISZ-5	Getr. / GBox: 12AS-2330TD LKPb15M1 / LKPC18M1 / LKPCL7M1	
				3400 117 801 ⊙ 3482 083 032 ⊙ 1878 085 741 ⊙ 3151 000 144	430 10 MFZ430 430WGTZ KZISZ-5	Getr. / GBox: 16AS-2601DD LKPb17E1 / LKPb18E1 / LKPb19E1 / LKPb19F1 / LKPC18E1 / LKPCL7E1 / LKPCL8E1	
				3400 117 801 ⊙ 3482 083 032 ⊙ 1878 085 741 ⊙ 3151 000 144	430 10 MFZ430 430WGTZ KZISZ-5	Getr. / GBox: 16S-221 LKPb15A1 / LKPb17A1 / LKPb18A1 / LKPb19A1 / LKPC18A1 / LKPCL7A1 / LKPCL8A1	
				3400 117 801 ⊙ 3482 083 032 ⊙ 1878 085 741 ⊙ 3151 000 144	430 10 MFZ430 430WGTZ KZISZ-5	Getr. / GBox: 16S-181OD LKPCL7C1 / LKPCL8C1	
				3400 117 801	430 10	Getr. / GBox: 16AS-2601OD	

IVECO

Stralis		02.02 -					
AS 190S50	12.06 -	F3BE3681		3400 700 366  3482 000 572  1878 004 132  3151 000 493	430 10 MFZ430 430WGTZ KZISZ-5	Getr. / GBox: 12AS-2330TD ZFFCLLB1 für Ausrückgabel mit Rollen / for release fork with rollers	(70)
				3400 700 461  3482 000 572  1878 004 132  3151 000 144	430 10 MFZ430 430WGTZ KZISZ-5	Getr. / GBox: 12AS-2330TD ZFFCLLB1 / ZFFCU8B1	
				 3400 700 461  3482 000 572  1878 004 132  3151 000 144	430 10 MFZ430 430WGTZ KZISZ-5	Getr. / GBox: 16S-2320TD ZFFB17A1 / ZFFCU8A1	
AS 260S40	02.02 -	F3AE0681		3400 117 801  3482 083 032  1878 085 741  3151 000 144	430 10 MFZ430 430WGTZ KZISZ-5	L3LC16D1 / L3LE14C3 / LCLC16A1 / LCLC16E1 / LCLCL7EA / LCLE14A1 / LCLE14E1 / LCLE15A1 / LCLE17A1 / LCLE17E1 / LCLE19E1 / LCLF15E1 / LCLF16E1 / LCLF17E1 / LCLFL6A1 / LCLFL7E1	
AS 260S43	02.02 -	F3AE0681		3400 117 801  3482 083 032  1878 085 741  3151 000 144	430 10 MFZ430 430WGTZ KZISZ-5	L3KC16D1 / L3KC16F1 / L3KC16G1 / L3KCL6G1 / L3KF16D1 / L3KFL6G1 / LCKC15A1 / LCKC15E1 / LCKC16A1 / LCKC16E1 / LCKC17A1 / LCKCL6A1 / LCKCL6E1 / LCKE14A1 / LCKE15A1 / LCKE15B1 / LCKE15E1 / LCKE16A1 / LCKE16E1 / LCKE17A1 / LCKE18E1 / LCKE19A1 / LCKE19E1 / LCKF15A1 / LCKF16A1 / LCKF16E1 / LCKF17A1	
		F3AE0681D		3400 700 462	430 10	Getr. / GBox: ZF16S-1920TD QUQB14A3 / ZUQCL6A3 / TUQB15A3 Nabensprofil / Hub Profile: 41,25x52,1x10Z	(46)
AS 260S43	05.05 -	F3AE3681		3400 700 395  3482 000 573  1878 004 581  3151 000 493	430 10 MFZ430 430WGTZ KZISZ-5	Getr. / GBox: 16S-1920TD QUQE14A3	
AS 260S44	02.02 -	F3BE0681		3400 117 801  3482 083 032  1878 085 741  3151 000 144	430 10 MFZ430 430WGTZ KZISZ-5	Getr. / GBox: 16AS 2601 DD Getr. / GBox: 16AS 2601 OD	
				3496 006 000		Getr. / GBox: 16AS 2601 DD Getr. / GBox: 16AS 2601 OD langer Bügel / long handle	(86)
AS 260S48	02.02 -	F3AE0681		3400 117 801  3482 083 032  1878 085 741  3151 000 144	430 10 MFZ430 430WGTZ KZISZ-5	L3PB18D1 / L3PC16D1 / L3PC16G3 / L3PE14G1 / L3PE16F1 / L3PF16C1 / L3PF16F1 / L3PF17F1 / LJPC15A1 / LJPC16A1 / LJPC16E1 / LJPE14A1 / LJPE14E1 / LJPE15A1 / LJPE15E1 / LJPE16A1 / LJPE16E1 / LJPE17A1 / LJPE17E1 / LJPE18F1 / LJPF15E1 / LJPF16A1 / LJPF16E1 / LJPF17E1	
AS 260S54	02.02 -	F3AE0681		3400 117 801  3482 083 032  1878 085 741  3151 000 144	430 10 MFZ430 430WGTZ KZISZ-5	L3RE15A1 / L3RE16A1 / LJRE14G1 / LJRE15G1 / LJRE16G1	
AS 440S35 AD		F2BE0681		3400 084 031  3482 078 134  1878 032 032  3151 000 144	400 10 MFZ400 400WGTZ KZISZ-5	Getr. / GBox: 16S-151	
				3496 006 000		Getr. / GBox: 16S-151 langer Bügel / long handle	(86)
AS 440S40	02.02 -	F3AE0681		3400 117 801  3482 083 032  1878 085 741  3151 000 144	430 10 MFZ430 430WGTZ KZISZ-5	L1LB21C1 / L1LB21D1 / L1LB21F1 / L1LB21G1 / L1LB23C1 / L1LB23D1 / L1LB23DA / L1LB23G1 / L1LCT1G1 / L1LCT1GA / L2LB21DA / L2LB21G1 / LALB21A1 / LALB21E1 / LALB23A1 / LALB23E1 / LALCT1A1 / LALCT1E1	
AS 440S40	02.02 -						
AS 440S42 AS 440S42 AT 440S42	05.06 - 07.06 - 07.06 -	F3AE3681D, F3AE3681B		3400 700 462	430 10	Getr. / GBox: ZF16S-1920TD QGDB21A1 / QGDB23A1 / QGDE21A2 / ZEDB21A1 / ZBDB21A1 / ZBDCT1A1 / TGDB21A1 / TMDB21A1 / TGDB23A1 / TGDBH1A1 / TGDBH3A1 / TGDCM3A1 / TGDCM3A3 / TGDCM3A3 / / TMDB21A3 / TGDB21A3 / TGDB23A3 / TGDBH3A3 / TGDCM3A3 / TGDCM3A3 / TGDCM3A3 / / ZEDB21A3 / ZBDB23A3 / ZBDB21A3 / ZBDBH3A3 / ZBDCT1A3 / QGDB21A3 / QGDB23A3 / QGDE21A4 / QGDE23A4 Nabensprofil / Hub Profile: 41,25x52,1x10Z	(46)
		F3AE3681		3400 700 395  3482 000 573  1878 004 581  3151 000 493	430 10 MFZ430 430WGTZ KZISZ-5	Getr. / GBox: 16S-1920TD ZBDB21A3 / ZBDB23A3 / ZBDCT1A3	













		CODE				
--	--	------	--	---	---	---

IVECO

Stralis		02.02 -					
AS 440S43	02.02 -	F3AE0681	 3400 117 801  3482 083 032  1878 085 741  3151 000 144	430 10 MFZ430 430WGTZ KZISZ-5	L1KB21C1 / L1KB21D1 / L1KB21F1 / L1KB21G1 / L1KB23D1 / L1KB23DA / L1KB23G1 / L1KCT1D1 / L2KB21DA / L2KB21G1 / L2KB21GA / LAKB21A1 / LAKB21E1 / LAKB23A1 / LAKB23E1 / LAKB23EA / LAKBH3A1 / LAKCT1A1 / LAKCT1E1 / LBKB21A1 / LBKB21E1 / LBKB21EA		
		F3AE0681D	 3400 700 462 ■	430 10	Getr. / GBox: ZF16S-1920TD ZTQB23A3 / TSQB21A3 / TSQB23A3 / TSQBH3A3 / TSQCT1A3 / TSQE21A4 / TSQE23A4 Nabenprofil / Hub Profile: 41,25x52,1x10Z	(46)	
AS 440S43	02.02 -	F3AE0681	 3400 117 801  3482 083 032  1878 085 741  3151 000 144	430 10 MFZ430 430WGTZ KZISZ-5	L1KB21C1 / L1KB21D1 / L1KB21F1 / L1KB21G1 / L1KB23D1 / L1KB23DA / L1KCT1D1 / L2KB21DA / L2KB21G1 / L2KB21GA / LAKB21A1 / LAKB21E1 / LAKB23A1 / LAKB23E1 / LAKB23EA / LAKBH3A1 / LAKCT1A1 / LAKCT1E1 / LBKB21A1 / LBKB21E1 / LBKB21EA		
		F3AE0681D	 3400 700 462 ■	430 10	Getr. / GBox: ZF16S-1920TD ZTQB23A3 / TSQB21A3 / TSQB23A3 / TSQBH3A3 / TSQCT1A3 / TSQE21A4 / TSQE23A4 Nabenprofil / Hub Profile: 41,25x52,1x10Z	(46)	
AS 440S44		F3BE0681	 3400 117 801  3482 083 032  1878 085 741  3151 000 144	430 10 MFZ430 430WGTZ KZISZ-5	Getr. / GBox: 16S-221 Getr. / GBox: 16AS 2601DD		
		 3496 006 000		Getr. / GBox: 16S-221 Getr. / GBox: 16AS 2601DD langer Bügel / long handle	(86)		
AS 440S45, AT 440S45 AS 440S45, AT 440S45	12.06 - 12.06 -	F3AE3681A	 3400 700 462 ■	430 10	Getr. / GBox: ZF16S-1920TD TMEB21A3 / TMEB21AC / TGECT1A3 / TGEB21A3 / TGECM3A3A / TJEBH2A3 / TJEBH2AC / TGEB23A3 / TGEB23AC / TGEBH3A3 / TGEE21A4 / ZBEB23A3 / ZBEB24AC / ZEEB21A3 / ZEEB21AC / ZBECT1A3 / ZBEB21A3 / ZBEBH1A3 / ZBEBH3A3 / QGEB21A3 / QGEB23A3 / QGEBH1A3 / QGEE21A4 / TMEB21A1 / TMEB21AA / TGECT1A1 / TGEB21A1 / TJEBH1A1 / TJEBH2AA / TGEB23AA / TGEB23A1 / TGEBH3A1 / TGECM3A1 / TGEE21A2 / TGEE23A2 / ZBEB21A1 / ZBEB23AA / ZEEB21A1 / ZEEB21AA / ZBEE23A2 / ZBEB23A1 / ZBEBH3A1 / ZBECT1A1 / QGEB23A1 / QGEB21A1 / QGEE21A2 / QGEE23A2 Nabenprofil / Hub Profile: 41,25x52,1x10Z		(46)
		F3AE3681	 3400 700 395  3482 000 573  1878 004 581  3151 000 493	430 10 MFZ430 430WGTZ KZISZ-5	Getr. / GBox: 16S-2220TD ZBEB21A3 / ZBEB23A3 / ZBECT1A3		
AS 440S48 AS 440S48	02.02 - 02.02 -	F3AE0681	 3400 117 801  3482 083 032  1878 085 741  3151 000 144	430 10 MFZ430 430WGTZ KZISZ-5	L1PB21C1 / L1PB21D1 / L1PB21F1 / L1PB21G1 / L1PB23C1 / L1PB23D1 / L1PB23DA / L1PB23G1 / L1PCT1B1 / L1PCT1J1 / L1PCT1K1 / LGPB21A1 / LGPB21E1 / LGPB23A1 / LGPB23E1 / LGPCT1C1 / LGPCT1G1 / LGPCT1GA / LHPB21A1 / LHPB21E1 / LHPB21EA		
AS 440S54	02.02 -	F3AE0681	 3400 117 801  3482 083 032  1878 085 741  3151 000 144	430 10 MFZ430 430WGTZ KZISZ-5	L1RB21A1 / L1RB21B1 / L1RB23B1 / L1RB23BA / L2RB21BA / LGRB21G1 / LGRB23G1		
AT 440S45	07.06 -	F3AE3681A	 3400 700 462 ■	430 10	Getr. / GBox: ZF16S-1920TD TMEB21A3 / TMEB21AC / TGECT1A3 / TGEB21A3 / TGECM3A3A / TJEBH2A3 / TJEBH2AC / TGEB23A3 / TGEB23AC / TGEBH3A3 / TGEE21A4 / ZBEB23A3 / ZBEB24AC / ZEEB21A3 / ZEEB21AC / ZBECT1A3 / ZBEB21A3 / ZBEBH1A3 / ZBEBH3A3 / QGEB21A3 / QGEB23A3 / QGEBH1A3 / QGEE21A4 / TMEB21A1 / TMEB21AA / TGECT1A1 / TGEB21A1 / TJEBH1A1 / TJEBH2AA / TGEB23AA / TGEB23A1 / TGEBH3A1 / TGECM3A1 / TGEE21A2 / TGEE23A2 / ZBEB21A1 / ZBEB23AA / ZEEB21A1 / ZEEB21AA / ZBEE23A2 / ZBEB23A1 / ZBEBH3A1 / ZBECT1A1 / QGEB23A1 / QGEB21A1 / QGEE21A2 / QGEE23A2 Nabenprofil / Hub Profile: 41,25x52,1x10Z		(46)























		CODE				
--	--	------	--	---	---	---

IVECO

Trakker		10.04 -						
Trakker Euro 6		Cursor9	 3400 700 365 3482 000 573 1878 004 133 3151 000 493	430 10 MFZ430 430WGTZ KZISZ-5	für / for: 400 PS Getr. / GBox: 16 S 1620 TD Getr. / GBox: 12 AS 1420 TD Getr. / GBox: 12 AS 1930 TD Getr. / GBox: 12 AS 2330 TO Abgasnorm: Euro 6 / Exhaust Emission Norm: Euro 6 für Ausrückgabel mit Rollen / for release fork with rollers	(68) (4) (70)		
		Cursor11	 3400 700 366 3482 000 572 1878 004 132 3151 000 493	430 10 MFZ430 430WGTZ KZISZ-5	für / for: 420 PS Getr. / GBox: 16 S 1920 TD Getr. / GBox: 16 S 2220 TO Getr. / GBox: 12 AS 1930 TD Getr. / GBox: 12 AS 2330 TD Getr. / GBox: 12 AS 2330 TO Abgasnorm: Euro 6 / Exhaust Emission Norm: Euro 6 für Ausrückgabel mit Rollen / for release fork with rollers	(68) (4) (70)		
		Cursor11	 3400 700 366 3482 000 572 1878 004 132 3151 000 493	430 10 MFZ430 430WGTZ KZISZ-5	für / for: 460 PS Getr. / GBox: 16 S 2220 TD Getr. / GBox: 16 S 2220 TO Getr. / GBox: 12 AS 2330 TD Getr. / GBox: 12 AS 2330 TO Abgasnorm: Euro 6 / Exhaust Emission Norm: Euro 6 für Ausrückgabel mit Rollen / for release fork with rollers	(68) (4) (70)		
		Cursor11	 3400 700 366 3482 000 572 1878 004 132 3151 000 493	430 10 MFZ430 430WGTZ KZISZ-5	für / for: 480 PS Getr. / GBox: 16 S 2320 TD Getr. / GBox: 16 S 2520 TO Getr. / GBox: 12 AS 2330 TD Getr. / GBox: 12 AS 2330 TO Abgasnorm: Euro 6 / Exhaust Emission Norm: Euro 6 für Ausrückgabel mit Rollen / for release fork with rollers	(68) (4) (70)		
		Cursor13	 3400 700 366 3482 000 572 1878 004 132 3151 000 493	430 10 MFZ430 430WGTZ KZISZ-5	für / for: 450 PS Getr. / GBox: 12 AS 2330 TD Getr. / GBox: 12 AS 2330 TO Getr. / GBox: 16 AS 2630 TO Abgasnorm: Euro 6 / Exhaust Emission Norm: Euro 6 für Ausrückgabel mit Rollen / for release fork with rollers	(68) (4) (70)		
		Cursor13	 3400 700 366 3482 000 572 1878 004 132 3151 000 493	430 10 MFZ430 430WGTZ KZISZ-5	für / for: 480 PS Getr. / GBox: 16 S 2220 TO Abgasnorm: Euro 6 / Exhaust Emission Norm: Euro 6 für Ausrückgabel mit Rollen / for release fork with rollers	(68) (4) (70)		
		Cursor13	 3400 700 366 3482 000 572 1878 004 132 3151 000 493	430 10 MFZ430 430WGTZ KZISZ-5	für / for: 500 PS Getr. / GBox: 16 S 2320 TD Getr. / GBox: 16 S 2520 TO Getr. / GBox: 12 AS 2330 TO Getr. / GBox: 16 AS 2630 TO Abgasnorm: Euro 6 / Exhaust Emission Norm: Euro 6 für Ausrückgabel mit Rollen / for release fork with rollers	(68) (4) (70)		
		Cursor13	 3400 700 366 3482 000 572 1878 004 132 3151 000 493	430 10 MFZ430 430WGTZ KZISZ-5	für / for: 560 PS Getr. / GBox: 16 S 2520 TO Getr. / GBox: 12 AS 2530 TO Abgasnorm: Euro 6 / Exhaust Emission Norm: Euro 6 für Ausrückgabel mit Rollen / for release fork with rollers	(68) (4) (70)		
		AD 180T27 W, AT 180T27 W	06.05 -	F2BE0681	 3400 107 031 3482 078 134 1862 317 031 3151 000 144	400 10 MFZ400 400GVZ KZISZ-5	Getr. / GBox: 9S109 KFKA12D2 / KFKA12DB / KFKA13D2 / KFKA13DB / KFKA14D2 / HFKA14D2	
		AD 190T27, AT 190T27	06.05 -	F2BE0681	 3400 107 031 3482 078 134 1862 317 031 3151 000 144	400 10 MFZ400 400GVZ KZISZ-5	Getr. / GBox: 9S109 KAKA12D1 / KAKA12D2 / KAKA13D1 / KAKA14D1 / KAKA15D1 / KAKA17D1 / HAKA14D1 / HAKA15D1	
		AD 190T31 W, AT 190T31 W	10.04 -	F2BE0681	 3400 084 031 3482 078 134 1878 032 032 3151 000 144	400 10 MFZ400 400WGTZ KZISZ-5	Getr. / GBox: 12AS2301DD KFPA12F2 / KFPA13F2 / KFPA14F2 / KFPB12F2 / HFPA14F2	
		AD 190T31 W, AT 190T31 W	06.05 -		 3400 107 031 3482 078 134 1862 317 031 3151 000 144	400 10 MFZ400 400GVZ KZISZ-5	Getr. / GBox: 9S109 KFPA12D2 / KFPA13D2 / KFPA14D2	
AD 190T31, AT 190T31	10.04 -	 3400 107 031 3482 078 134 1862 317 031 3151 000 144	400 10 MFZ400 400GVZ KZISZ-5		Getr. / GBox: 16S109 KAPA12A1 / KAPA13A1 / KAPA13A2 / KAPA14A1 / KAPA15A1 / KAPA17A1 / KFPA12A2 / KFPA13A2 / KFPA14A2 / KFPB13A2 / KFPB14A2 / HFPA12A2 /			

















		CODE				
--	--	------	--	---	---	---

IVECO

Trakker		10.04 -					
AD 190T31 W, AT 190T31 W AD 190T33 W, AT 190T33 W AD 190T33, AT 190T33 AD 260T33, AT 260T33	01.13- 01.13- 01.13- 01.13-	Cursor9	   	3400 700 365 ⊗ 3482 000 573 ⊗ 1878 004 133 ⊙ 3151 000 493 3400 700 377 ⊗ 3482 000 628 ⊗ 1878 004 581 ⊙ 3151 000 651	430 10 MFZ430 430WGTZ KZISZ-5 430 10 MF430 430WGTZ KZIS-4	Getr. / GBox: 16 S 1620 TD Getr. / GBox: 12 AS 1420 TD Getr. / GBox: 12 AS 1930 TD Getr. / GBox: 12 AS 2330 TO Abgasnorm: Euro 6 / Exhaust Emission Norm: Euro 6 für Ausrückgabel mit Rollen / for release fork with rollers	(4) (70)
AD 190T33 W, AT 190T33 W AD 190T33, AT 190T33	03.06- 03.06-	F2BE3681	   	3400 700 365 ⊗ 3482 000 573 ⊗ 1878 004 133 ⊙ 3151 000 493 3400 700 365 ⊗ 3482 000 573 ⊗ 1878 004 133 ⊙ 3151 000 493 3400 700 378 ⊗ 3482 000 573 ⊗ 1878 004 133 ⊙ 3151 000 144 3400 700 378 ⊗ 3482 000 573 ⊗ 1878 004 133 ⊙ 3151 000 144	430 10 MFZ430 430WGTZ KZISZ-5 430 10 MFZ430 430WGTZ KZISZ-5 430 10 MFZ430 430WGTZ KZISZ-5 430 10 MFZ430 430WGTZ KZISZ-5	Getr. / GBox: 12AS1420TD KUBA13C3 / KUBA15C3 / KUBA15C6 für Ausrückgabel mit Rollen / for release fork with rollers Getr. / GBox: 12AS1930TD KUCA13C3 / KUCB15C3 für Ausrückgabel mit Rollen / for release fork with rollers Getr. / GBox: 12AS1930TD KUCA13C3 / KUCB13C3 / KUCB15C3 Getr. / GBox: 16S1620TD KUBA13A3 / KUCA13A3 / KUCA14A3 / KUCB14A3	(70) (70)
AD 190T35 W, AD 190T36 W, AT 190T35 W, AT 190T36 W AD 190T35 W, AT 190T35 W, AD 190T36 W, AT 190T36 W AD 190T35, AD 190T36, AT 190T35, AT 190T36 AD 190T35, AT 190T35, AD 190T36, AT 190T36	10.04- 01.05- 10.04- 06.05-	F2BE0681 F2BE3681	   	3400 084 031 ⊗ 3482 078 134 ⊗ 1878 032 032 ⊙ 3151 000 144 3400 084 031 ⊗ 3482 078 134 ⊗ 1878 032 032 ⊙ 3151 000 144 3400 700 365 ⊗ 3482 000 573 ⊗ 1878 004 133 ⊙ 3151 000 493 3400 700 378 ⊗ 3482 000 573 ⊗ 1878 004 133 ⊙ 3151 000 144	400 10 MFZ400 400WGTZ KZISZ-5 400 10 MFZ400 400WGTZ KZISZ-5 430 10 MFZ430 430WGTZ KZISZ-5 430 10 MFZ430 430WGTZ KZISZ-5	Getr. / GBox: 12AS2301DD HFRA14F2 / HFRB14F2 / KFRA12F2 / KFRA13F2 / KFRB12F2 / KFRB13F2 / KFRB14F2 Getr. / GBox: 16S151 HARA13A1 / HFRB12A2 / KARA12A1 / KARA13A1 / KARA13A2 / KARA14A1 / KARA15A1 / KARA17A1 / KFRA12A2 / KFRA13A2 / KFRA14A2 / KFRB12A2 / KFRB13A2 / KFRB14A2 Getr. / GBox: 12AS1930TD KUCB13C6 / HUCB15C3 für Ausrückgabel mit Rollen / for release fork with rollers Getr. / GBox: 12AS1930TD HUCB15C3	(70)
AD 190T36 W, AT 190T36 W AD 190T36, AT 190T36 AD 260T36, AT 260T36 AD 340T36, AT 340T36 AD 400T36 T, AT 400T36 T	01.13- 01.13- 01.13- 01.13- 01.13-	Cursor9	    	3400 700 365 ⊗ 3482 000 573 ⊗ 1878 004 133 ⊙ 3151 000 493	430 10 MFZ430 430WGTZ KZISZ-5	Getr. / GBox: 16 S 1620 TD Getr. / GBox: 12 AS 1420 TD Getr. / GBox: 12 AS 1930 TD Getr. / GBox: 12 AS 2330 TO Abgasnorm: Euro 6 / Exhaust Emission Norm: Euro 6 für Ausrückgabel mit Rollen / for release fork with rollers	(4) (70)
AD 190T38 W, AT 190T38 W AD 190T38 W, AT 190T38 W AD 190T38, AT 190T38 AD 190T38, AT 190T38	10.04- 06.05- 10.04- 10.04-	F3BE0681 F3BE3681	    	3400 117 801 ⊗ 3482 083 032 ⊗ 1878 085 741 ⊙ 3151 000 144 3400 117 801 ⊗ 3482 083 032 ⊗ 1878 085 741 ⊙ 3151 000 144 3400 700 366 ⊗ 3482 000 572 ⊗ 1878 004 132 ⊙ 3151 000 493 3400 700 461 ⊗ 3482 000 572 ⊗ 1878 004 132 ⊙ 3151 000 144 3400 700 461 ⊗ 3482 000 572 ⊗ 1878 004 132 ⊙ 3151 000 144	430 10 MFZ430 430WGTZ KZISZ-5 430 10 MFZ430 430WGTZ KZISZ-5 430 10 MFZ430 430WGTZ KZISZ-5 430 10 MFZ430 430WGTZ KZISZ-5	Getr. / GBox: 12AS2301OD KFLA12E2 / KFLA13E2 / KFLA14E2 / KFLA14EB / HFLA14E2 Getr. / GBox: 16S151OD KFLA12B2 / KFLA13B2 / KFLA14B2 / H0UBK4B1 / HALA13B1 / HFLA13B2 / K0UAK2B1 / K0UAK3B1 / K0UAK4B1 / K0UAK5B1 / K0UAK5BA / K0UBK2B1 / K0UBK3B1 / K0UBK4B1 / KALA12B1 / KALA12B2 / KALA13B1 / KALA13B2 / KALA14B1 / KALA14B2 / KALA15B1 Getr. / GBox: 12AS2330TO KYEC13C3 für Ausrückgabel mit Rollen / for release fork with rollers Getr. / GBox: 12AS2330TO KYEC13C3 Getr. / GBox: 16S2220TO KYEC13A3	(70)















		CODE				
--	--	------	--	---	---	---

IVECO

Trakker		10.04 -					
AD 190T41 W, AT 190T41 W AD 190T41, AT 190T41	03.06-	F3BE3681	 3400 700 366 ⊗ 3482 000 572 ⊗ 1878 004 132 ⊙ 3151 000 493	430 10 MFZ430 430WGTZ KZISZ-5	Getr. / GBox: 12AS2330TO KUDA15C3 / KUDA15C6 für Ausrückgabel mit Rollen / for release fork with rollers	(70)	
	03.06-		 3400 700 461 ⊗ 3482 000 572 ⊗ 1878 004 132 ⊙ 3151 000 144	430 10 MFZ430 430WGTZ KZISZ-5	Getr. / GBox: 12AS2330TO KUDA15C3 / KUDA14C3		
			 3400 700 461 ⊗ 3482 000 572 ⊗ 1878 004 132 ⊙ 3151 000 144	430 10 MFZ430 430WGTZ KZISZ-5	Getr. / GBox: 16S2220TO KLDA13A1 / KLDA14A1 / KLDA16A1 / KUDA13A3 / KUDA14A3		
AD 190T44 W, AD 190T45 W, AT 190T44 W, AD 190T45W AD 190T44 W, AT 190T44 W, AD 190T45W, AT 190T45W AD 190T44, AD 190T45, AT 190T44, AT 190T45 AD 190T44, AT 190T44, AD 19T45, AT 190T45	10.04-	F3BE0681	 3400 117 801 ⊗ 3482 083 032 ⊗ 1878 085 741 ⊙ 3151 000 144	430 10 MFZ430 430WGTZ KZISZ-5	Getr. / GBox: 12AS2301OD KFMA12E2 / HFMA14E2 / KFMA13E2 / KFMA14E2 / HFMA12E2		
	06.05-		 3400 117 801 ⊗ 3482 083 032 ⊗ 1878 085 741 ⊙ 3151 000 144	430 10 MFZ430 430WGTZ KZISZ-5	Getr. / GBox: 16S1810D KAMA12B1 / KAMA13B1 / KAMA13B2 / KAMA14B1 / KAMA15B1 / KFMA12B2 / HFMA13B2 / HFMA14B2 / KFMA13B2 / KFMA14B2 / HAMA13B1 / HAMA14B1 / HAMA15B1 / HFMA12B2		
	10.04-	F3BE3681	 3400 700 366 ⊗ 3482 000 572 ⊗ 1878 004 132 ⊙ 3151 000 493	430 10 MFZ430 430WGTZ KZISZ-5	Getr. / GBox: 12AS2330TO KUEA13C3 für Ausrückgabel mit Rollen / for release fork with rollers	(70)	
			 3400 700 461 ⊗ 3482 000 572 ⊗ 1878 004 132 ⊙ 3151 000 144	430 10 MFZ430 430WGTZ KZISZ-5	Getr. / GBox: 12AS2330TO KUEA13C3		
	06.05-		 3400 700 461 ⊗ 3482 000 572 ⊗ 1878 004 132 ⊙ 3151 000 144	430 10 MFZ430 430WGTZ KZISZ-5	Getr. / GBox: 16S2220TO KLEA13A1 / KLEA14A1 / KLEA17A1 / KUEA13A3 / KUEA14A3		
	AD 260T31 B AD 260T31, AT 260T31 AD 260T31, AT 260T31	06.05-	F2BE0681	 3400 084 031 ⊗ 3482 078 134 ⊗ 1878 032 032 ⊙ 3151 000 144	400 10 MFZ400 400WGTZ KZISZ-5	Getr. / GBox: 12AS2301DD KCPA12F1 / KCPA13FA / KCPA14FA / KCPA15F1 / KCPA15FA / KCPA16F1 / KCPA17F1 / KCPA17FA	
10.04-		 3400 107 031 ⊗ 3482 078 134 ⊗ 1862 317 031 ⊙ 3151 000 144		400 10 MFZ400 400GVZ KZISZ-5	Getr. / GBox: 9S109 KCPA12D1 / KCPA13D1 / KCPA14D1 / KCPA14DA / KCPA15D1 / KCPA15DA / KCPA16D1 / KCPA17D1 / KCPA18D1 / KCPA72D1 / KCPA73D1 / KCPA74D1 / KCPA73D1 / KCPG72D1 / KCPG73D1 / KCPG74DA		
10.04-		 3400 107 031 ⊗ 3482 078 134 ⊗ 1862 317 031 ⊙ 3151 000 144		400 10 MFZ400 400GVZ KZISZ-5	Getr. / GBox: 16S109 KCPA12A1 / KCPA13A1 / KCPA14A1 / KCPA15A1 / KCPA16A1 / KCPA17A1 / HCPA17AA		
AD 260T33 B AD 260T33, AD 380T33, AT 260T33, AT 380T33	07.07-	F2BE3681	 3400 700 365 ⊗ 3482 000 573 ⊗ 1878 004 133 ⊙ 3151 000 493	430 10 MFZ430 430WGTZ KZISZ-5	Getr. / GBox: 12AS1420TD KNBA12CA / KNBD13CA / KNBD16CA für Ausrückgabel mit Rollen / for release fork with rollers	(70)	
	03.06-		 3400 700 378 ⊗ 3482 000 573 ⊗ 1878 004 133 ⊙ 3151 000 144	430 10 MFZ430 430WGTZ KZISZ-5	Getr. / GBox: 12AS1420TD KNBA12CA / KNBD13CA		
		F4AE3681	 3400 700 365 ⊗ 3482 000 573 ⊗ 1878 004 133 ⊙ 3151 000 493	430 10 MFZ430 430WGTZ KZISZ-5	Getr. / GBox: FS-8309A(B) KNBA72C1 für Ausrückgabel mit Rollen / for release fork with rollers	(70)	
AD 260T35 B AD 260T35 W, AT 260T35 W AD 260T35, AT 260T35	06.05-	F2BE0681	 3400 084 031 ⊗ 3482 078 134 ⊗ 1878 032 032 ⊙ 3151 000 144	400 10 MFZ400 400WGTZ KZISZ-5	Getr. / GBox: 12AS2301DD KHRA14F2 / HCRA13F1 / HCRA15FA / HCRG17FA / KCRA12F1 / KCRA13F1 / KCRA14F1 / KCRA15F1 / KCRA16F1 / KCRA17F1 / KCRA18F1		
	06.05- 10.04-		 3400 084 031 ⊗ 3482 078 134 ⊗ 1878 032 032 ⊙ 3151 000 144	400 10 MFZ400 400WGTZ KZISZ-5	Getr. / GBox: 16S151 KCRG74AA / KHRA13A2 / KHRA14A2 / HCRA14A1 / HCRA15A1 / HCRA16A1 / HCRA17A1 / HCRA17AA / KCRA12A1 / KCRA13A1 / KCRA14A1 / KCRA15A1 / KCRA16A1 / KCRA17A1 / KCRA18A1 / KCRA72A1 / KCRA73A1 / KCRA74A1		















		CODE				
--	--	------	--	---	---	---

IVECO

Trakker		10.04 -					
AD 260T36 B AD 260T36 W, AD 380T36 W, AT 260T36 W, AT 380T36 W AD 260T36, AT 260T36	07.07 -	F2BE3681	 3400 700 365 ⊗ 3482 000 573 ⊗ 1878 004 133 ⊙ 3151 000 493	430 10 MFZ430 430WGTZ KZISZ-5	Getr. / GBox: 12AS1930TD KNCA11C1 / KNCA12C1 / KNCA13C1 / KNCA15C1 / / KNCA16C1 / KNCA17C1 / KNCD13CA / KNCD16CA / KNCF73CA / KXCB13C3 für Ausrückgabel mit Rollen / for release fork with rollers	(70)	
	10.04 -		 3400 700 378 ⊗ 3482 000 573 ⊗ 1878 004 133 ⊙ 3151 000 144	430 10 MFZ430 430WGTZ KZISZ-5	Getr. / GBox: 12AS1930TD KXCB13C3		
	03.06 -		 3400 700 378 ⊗ 3482 000 573 ⊗ 1878 004 133 ⊙ 3151 000 144	430 10 MFZ430 430WGTZ KZISZ-5	Getr. / GBox: 16S1620TD KXCB12A3 / KXCB13A3		
AD 260T38 , AT 260T38 AD 260T38 B AD 260T38 W, AT 260T38 W AD 260T38, AD 260T38 /P, AT 260T38	10.04 -	F3BE0681	 3400 117 801 ⊗ 3482 083 032 ⊗ 1878 085 741 ⊙ 3151 000 144	430 10 MFZ430 430WGTZ KZISZ-5	Getr. / GBox: 12AS2301OD KCLA12E1 / KCLA13E1 / KCLA14E1 / KCLA15E1 / KCLA16E1 / KCLA17E1 / KCLA18E1 / KCLE12E1 / KCLE13E1 / KCLE14E1 / KCLE16E1 / KHLA13E2 / KHLA14E2 / HCLA16E1 / HCLA17E1 / HCLE13E1		
	06.05 - 06.05 -		 3400 117 801 ⊗ 3482 083 032 ⊗ 1878 085 741 ⊙ 3151 000 144	430 10 MFZ430 430WGTZ KZISZ-5	Getr. / GBox: 16S1510D KCLA12B1 / KCLA13B1 / KCLA14B1 / KCLA15B1 / KCLA16B1 / KCLA17B1 / KCLA18B1 / KCLE13B1 / KCLE14B1 / KCLE15B1 / KCLE16B1 / KCLE17B1 / KHLA13B2 / KHLA14B2 / HCLA13B1 / HCLA15B1 / HCLA16B1 / HCLA17B1 / HCLE16B1 / HCLE17B1 / HHLA13B2		
AD 260T41 W, AD 380T41 W, AT 260T41 W, AT 380T41 W AD 260T41, AD 380T41, AT 260T41, AT 380T41	03.06 -	F3BE3681	 3400 700 366 ⊗ 3482 000 572 ⊗ 1878 004 132 ⊙ 3151 000 493	430 10 MFZ430 430WGTZ KZISZ-5	Getr. / GBox: 12AS2330TO KXDB12C3 / HNDE14C1 / HNDE15C1 für Ausrückgabel mit Rollen / for release fork with rollers	(70)	
	03.06 -		 3400 700 461 ⊗ 3482 000 572 ⊗ 1878 004 132 ⊙ 3151 000 144	430 10 MFZ430 430WGTZ KZISZ-5	Getr. / GBox: 12AS2330TO KXDB12C3 / HNDE15C1		
AD 260T44 W, AT 260T44 W AD 260T44, AD 260T44 /P, AT 260T44	06.05 -	F3BE0681	 3400 117 801 ⊗ 3482 083 032 ⊗ 1878 085 741 ⊙ 3151 000 144	430 10 MFZ430 430WGTZ KZISZ-5	Getr. / GBox: 12AS2301OD KHMA13E2 / KHMA14E2 / HCMA13E1 / HCMA14E1 / / HCMA15E1 / HCMA16E1 / HCME14E1 / HCME15E1 / HCME16E1 / HCME17E1 / HHMA13E2 / HHMA14E2 / KCMA12E1 / KCMA13E1 / KCMA14E1 / KCMA15E1 / KCMA16E1 / KCME12E1 / KCME14E1 / KCME15E1 / KCME16E1		
	06.05 -		 3400 117 801 ⊗ 3482 083 032 ⊗ 1878 085 741 ⊙ 3151 000 144	430 10 MFZ430 430WGTZ KZISZ-5	Getr. / GBox: 16S1810D KHMA14B2 / HCMA12B1 / HCMA13B1 / HCMA14B1 / HCMA16B1 / HCMA17B1 / HHMA14B2 / KCMA12B1 / KCMA13B1 / KCMA14B1 / KCMA15B1 / KCMA16B1 / KCMA17B1 / KCME13B1 / KCME14B1 / KCME15B1 / KCME16B1 / KCME17B1 / KHMA13B2		
AD 260T45 W, AD 380T45 W, AT 260T45 W, AT 380T45 W AD 260T45, AD 380T45, AT 260T45, AT 380T45	03.06 -	F3BE3681	 3400 700 366 ⊗ 3482 000 572 ⊗ 1878 004 132 ⊙ 3151 000 493	430 10 MFZ430 430WGTZ KZISZ-5	Getr. / GBox: 12AS2330TO HNEE16C1 / HXEB13C3 / KNEB11C1 / KNEB13C1 / KNEB14C1 / KNEB15C1 / KNEE11C1 / KXEB12C3 / KXEB12C6 / KXEB13C3 / HNEB12C1 / HNEB14C1 / HNEE15C1 / KPEC12C4 / KSEB11C1 / KSEB13C1 / KSEB71C1 / KSED13CA / KSEE11C1 / KSEE12C1 / KSEE13C1 / KSEE14C1 / HPEC11C1 / HPEC14C1 / HYEC13C3 für Ausrückgabel mit Rollen / for release fork with rollers	(70)	
	03.06 -		 3400 700 366 ⊗ 3482 000 572 ⊗ 1878 004 132 ⊙ 3151 000 493	430 10 MFZ430 430WGTZ KZISZ-5	Getr. / GBox: 16S2220TO KPEC11C4 für Ausrückgabel mit Rollen / for release fork with rollers	(70)	
			 3400 700 461 ⊗ 3482 000 572 ⊗ 1878 004 132 ⊙ 3151 000 144	430 10 MFZ430 430WGTZ KZISZ-5	Getr. / GBox: 12AS2330TO KNEB11C1 / KNEB13C1 / KNEB14C1 / KNEB15C1 / KNEE12C1 / KXEB13C3 / HNEB12C1 / KSEB11C1 / KSEB12C1 / KSEB71C1 / KSED13CA / KSEE11C1 / KSEE12C1 / KSEE13C1 / KSEE14C1		
			 3400 700 461 ⊗ 3482 000 572 ⊗ 1878 004 132 ⊙ 3151 000 144	430 10 MFZ430 430WGTZ KZISZ-5	Getr. / GBox: 16S2220TO KNEB11A1 / KNEB12A1 / KXEB12A3 / KSEB11A1 / KSEB12A1 / KSEB13A1 / KSEB71A1 / KSEB72A1 / KSEE13A1		
AD 260T48, AT 260T48	06.05 -	F3BE0681	 3400 117 801 ⊗ 3482 083 032 ⊗ 1878 085 741 ⊙ 3151 000 144	430 10 MFZ430 430WGTZ KZISZ-5	Getr. / GBox: 12AS2301OD KCSA12E1 / KCSA13E1 / KCSA14E1 / KCSE12E1 / KCSE14E1 / HCSA12E1 / HCSA13E1 / HCSA14E1 / HCSA16E1 / HCSE14E1		
			 3400 117 801 ⊗ 3482 083 032 ⊗ 1878 085 741 ⊙ 3151 000 144	430 10 MFZ430 430WGTZ KZISZ-5	Getr. / GBox: 16S2210D KCSA12B1 / KCSA13B1 / KCSA14B1 / KCSE12B1 / KCSE14B1 / HCSA12B1 / HCSA13B1 / HCSA14B1 / HCSA15B1 / HCSA16B1 / HCSE13B1 / HCSE14B1 /		

















		CODE				
--	--	------	--	---	---	---

IVECO

Trakker		10.04 -					
AD 260T50, AD 380T50, AT 260T50, AT 380T50	03.06-	F3BE3681	 3400 700 366 ⊗ 3482 000 572 ⊗ 1878 004 132 ⊙ 3151 000 493	430 10 MFZ430 430WGTZ KZISZ-5	Getr. / GBox: 12AS2330TO KNFB11C1 / KNFB13C1 / KNFE15C1 / HNFB11C1 / HNFB12C1 / HNFB15C1 / HNFE15C1 / KPFC11C1 / KPFC11C4 / KPFC12C4 / HPFC14C1 für Ausrückgabel mit Rollen / for release fork with rollers	(70)	
			 3400 700 461 ⊗ 3482 000 572 ⊗ 1878 004 132 ⊙ 3151 000 144	430 10 MFZ430 430WGTZ KZISZ-5	Getr. / GBox: 12AS2330TO KNFB11C1 / HNFB11C1 / KPFC11C1		
			 3400 700 461 ⊗ 3482 000 572 ⊗ 1878 004 132 ⊙ 3151 000 144	430 10 MFZ430 430WGTZ KZISZ-5	Getr. / GBox: 16S2520TO KPFC11A1 / KPFC12A1		
AD 340T35 B, AT 340T35 B	06.05-	F2BE0681	 3400 084 031 ⊗ 3482 078 134 ⊗ 1878 032 032 ⊙ 3151 000 144	400 10 MFZ400 400WGTZ KZISZ-5	Getr. / GBox: 12AS2301DD KERA11F1 / KERA13A1 / KERA13FA / KERG13FA / KERH13FA		
			 3400 084 031 ⊗ 3482 078 134 ⊗ 1878 032 032 ⊙ 3151 000 144	400 10 MFZ400 400WGTZ KZISZ-5	Getr. / GBox: 16S151 KERA11A1 / KERA13A1 / KERA13AA / KERA71A1 / KERA73A1 / KERG13AA / KERG14AA		
AD 340T36, AT 340T36 AD 340T36, AT 340T36	03.06- 07.07-	F2BE3681	 3400 700 365 ⊗ 3482 000 573 ⊗ 1878 004 133 ⊙ 3151 000 493	430 10 MFZ430 430WGTZ KZISZ-5	Getr. / GBox: 12AS1930TD KSCD13CE / KSCF71C5 / HSCF14CA für Ausrückgabel mit Rollen / for release fork with rollers	(70)	
AD 340T38 B, AT 34T38 B	06.05-	F3BE0681	 3400 117 801 ⊗ 3482 083 032 ⊗ 1878 085 741 ⊙ 3151 000 144	430 10 MFZ430 430WGTZ KZISZ-5	Getr. / GBox: 12AS2301OD KELA11E1 / KELA13E1 / KELA13EA / KELE13E1 / KELG13EA		
			 3400 117 801 ⊗ 3482 083 032 ⊗ 1878 085 741 ⊙ 3151 000 144	430 10 MFZ430 430WGTZ KZISZ-5	Getr. / GBox: 16S151OD KELA11B1 / KELA12B1 / KELA13B1 / KELA13BA / KELA71B1 / KELA72B1 / KELA73B1 / KELC71B1 / KELE12B1 / KELE13B1 / KELG13BA / KELH14BA / KELH71B1		
AD 340T41 B AD 340T41, AT 340T41 AD 340T41, AT 340T41	06.06- 03.06- 06.06-	F3BE3681	 3400 700 366 ⊗ 3482 000 572 ⊗ 1878 004 132 ⊙ 3151 000 493	430 10 MFZ430 430WGTZ KZISZ-5	Getr. / GBox: 12AS2330TO KSDB11C1 / KSDB12C1 / KSDB13C1 / KSDB13CA / KSDB14C1 / KSDB71C1 / KSDB73C1 / KSDB73CA / KSDD13CA / KSDD13CE / KSDE11C1 / KSDF71C1 / HSDB12C1 / HSDB13C1 / HSDB14CA / HSDD14CA für Ausrückgabel mit Rollen / for release fork with rollers	(70)	
			 3400 700 461 ⊗ 3482 000 572 ⊗ 1878 004 132 ⊙ 3151 000 144	430 10 MFZ430 430WGTZ KZISZ-5	Getr. / GBox: 12AS2330TO KSDB13C1 / KSDB71C1 / KSDD13CA / HSDB14CA / HSDD14CA		
			 3400 700 461 ⊗ 3482 000 572 ⊗ 1878 004 132 ⊙ 3151 000 144	430 10 MFZ430 430WGTZ KZISZ-5	Getr. / GBox: 16S2220TO KSDB11A1 / KSDB71A1 / KSDE12A1 / KSDE13A1 / KSDF71A1		
AD 340T44 B, AT 340T44 B	06.05-	F3BE0681	 3400 117 801 ⊗ 3482 083 032 ⊗ 1878 085 741 ⊙ 3151 000 144	430 10 MFZ430 430WGTZ KZISZ-5	Getr. / GBox: 12AS2301OD KEMA11E1 / KEMA12E1 / KEMA13E1 / KEMA13EA / KEME11E1 / KEME12E1 / KEME13E1 / KEMG13EA / HEMA11E1 / HEMA12E1 / HEME12E1 / HEME13E1		
			 3400 117 801 ⊗ 3482 083 032 ⊗ 1878 085 741 ⊙ 3151 000 144	430 10 MFZ430 430WGTZ KZISZ-5	Getr. / GBox: 16S181OD KEMA11B1 / KEMA12B1 / KEMA13B1 / KEMA13BA / KEMA71B1 / KEMA73B1 / KEME11B1 / KEME12B1 / KEME13B1 / HEMA11B1 / HEMA12B1 / HEMA13B1 / HEMA14BA / HEMA72B1 / HEME12B1 / HEMG14BA		
AD 340T45 B AD 340T45, AD 340T45 /P, AT 340T45, AT 34T45 /P AD 340T45, AT 340T45	06.06- 06.06- 03.06-	F3BE3681	 3400 700 366 ⊗ 3482 000 572 ⊗ 1878 004 132 ⊙ 3151 000 493	430 10 MFZ430 430WGTZ KZISZ-5	Getr. / GBox: 12AS2330TO KSEB11C4 / HSEB11C1 / HSEB12C1 / HSED14CA / HSEE13C1 für Ausrückgabel mit Rollen / for release fork with rollers	(70)	
			 3400 700 461 ⊗ 3482 000 572 ⊗ 1878 004 132 ⊙ 3151 000 144	430 10 MFZ430 430WGTZ KZISZ-5	Getr. / GBox: 12AS2330TO HSEB11C1 / HSED14CA / HSEE12C1 / HSEE13C1		













		CODE				
--	--	------	--	---	---	---

IVECO

Trakker		10.04 -					
AD 380T38 B AD 380T38, AT 380T38	06.05- 01.05-	F3BE0681	 3400 117 801 ⊗ 3482 083 032 ⊗ 1878 085 741 ⊙ 3151 000 144	430 10 MFZ430 430WGTZ KZISZ-5	Getr. / GBox: 12AS2301OD KCLD12E1 / KCLD12E2 / KCLD13E1 / KCLD14E1 / KCLD14E2 / KCLD15E1 / KCLD15E2 / KHL13E2 / KHL14E2 / KHL14EB / HELG14EA		
			 3400 117 801 ⊗ 3482 083 032 ⊗ 1878 085 741 ⊙ 3151 000 144	430 10 MFZ430 430WGTZ KZISZ-5	Getr. / GBox: 16S151OD K3UBK3B1 / K3UBK4B1 / KCLD12B1 / KCLD12B2 / KCLD13B1 / KCLD13B2 / KCLD14B1 / KCLD15B1 / KCLD16B1 / KCLD72B1 / KCLD73B1 / KCLD74B1 / KHL13B2 / KHL14B2 / H3UAK3B1 / H3UAK4B1 / H3UAK5B1 / H3UBK4B1 / HCLD13B1 / HCLD14B1 / HCLD14B2 / HCLD15B1 / HCLD16B1 / HELA11B1 / HELA12B1 / HELA13B1 / HELA71B1 / HELG14BA / HHL13B2 / HHL14B2 / K3UAK2B1 / K3UAK3B1 / K3UAK3BA / K3UAK4B1 / K3UAK4BA / K3UAK5B1 / K3UAK6B1		
			 3400 117 801 ⊗ 3482 083 032 ⊗ 1878 085 741 ⊙ 3151 000 144	430 10 MFZ430 430WGTZ KZISZ-5	Getr. / GBox: 16S221OD KCLD13C1 / KCLD13C2		
AD 380T44 B AD 380T44 W, AT 380T44 W AD 380T44, AT 380T44	06.05- 06.05- 06.05-	F3BE0681	 3400 117 801 ⊗ 3482 083 032 ⊗ 1878 085 741 ⊙ 3151 000 144	430 10 MFZ430 430WGTZ KZISZ-5	Getr. / GBox: 12AS2301OD KCMD12E1 / KCMD13E1 / KCMD14E1 / KCMD14E2 / KCMD15E1 / KHMD13E2 / KHMD14E2 / KHMD14EB / HCMD13E1 / HCMD14E1 / HCMD15E1 / HHMD13E2 / HHMD14E2		
			 3400 117 801 ⊗ 3482 083 032 ⊗ 1878 085 741 ⊙ 3151 000 144	430 10 MFZ430 430WGTZ KZISZ-5	Getr. / GBox: 16S181OD KCMD12B1 / KCMD13B1 / KCMD14B1 / KCMD15B1 / KCMD72B1 / KHMD13B2 / KHMD14B2 / HCMD12B1 / HCMD13B1 / HCMD14B1 / HCMD16B1 / HHMD14B2		
AD 380T48, AD 380T48	06.05-	F3BE0681	 3400 117 801 ⊗ 3482 083 032 ⊗ 1878 085 741 ⊙ 3151 000 144	430 10 MFZ430 430WGTZ KZISZ-5	Getr. / GBox: 12AS2301OD KCSD12E1 / KCSD14EA / KCSD15E1 / HCSD13E1 / HCSD15E1		
			 3400 117 801 ⊗ 3482 083 032 ⊗ 1878 085 741 ⊙ 3151 000 144	430 10 MFZ430 430WGTZ KZISZ-5	Getr. / GBox: 16S221OD KCSD12B1 / KCSD13B1 / KCSD14B1 / KCSD15B1 / HCSD12B1 / HCSD13B1 / HCSD14B1 / HCSD15B1		
AD 400T35 T, AT 400T35 T	06.05-	F2BE0681	 3400 084 031 ⊗ 3482 078 134 ⊗ 1878 032 032 ⊙ 3151 000 144	400 10 MFZ400 400WGTZ KZISZ-5	Getr. / GBox: 16S151 KBRA22A1 / KBRA21A1		
AD 400T36 T, AT 400T36 T	10.04-	F2BE3681	 3400 700 378 ⊗ 3482 000 573 ⊗ 1878 004 133 ⊙ 3151 000 144	430 10 MFZ430 430WGTZ KZISZ-5	Getr. / GBox: 16S1620TD KMCA21A1		
AD 400T38 T, AT 400T38 T AD 400T38 WT, AT 400T38 WT	06.05- 06.05-	F3BE0681	 3400 117 801 ⊗ 3482 083 032 ⊗ 1878 085 741 ⊙ 3151 000 144	430 10 MFZ430 430WGTZ KZISZ-5	Getr. / GBox: 12AS2301OD KGLA23E2 / HBLA22E1		
			 3400 117 801 ⊗ 3482 083 032 ⊗ 1878 085 741 ⊙ 3151 000 144	430 10 MFZ430 430WGTZ KZISZ-5	Getr. / GBox: 16S151OD K0UAH1B1 / K0UAH2B1 / K5UAK1B1 / K5UAK3B1 / K5UAK4B1 / KBLA21B1 / KBLA22B1 / KGLA23B2 / H0UAH1B1 / H0UAH2B1 / HBLA22B1 / HGLA23B2		
AD 400T41 T, AT 400T41 T AD 400T41 WT, AT 400T41 WT	03.06- 03.06-	F3BE3681	 3400 700 366 ⊗ 3482 000 572 ⊗ 1878 004 132 ⊙ 3151 000 493	430 10 MFZ430 430WGTZ KZISZ-5	Getr. / GBox: 12AS2330TO KMDB22C1 / KVDA22C3 / HMDA22C1 / HVDA22C3 für Ausrückgabel mit Rollen / for release fork with rollers (70)		
			 3400 700 461 ⊗ 3482 000 572 ⊗ 1878 004 132 ⊙ 3151 000 144	430 10 MFZ430 430WGTZ KZISZ-5	Getr. / GBox: 12AS2330TO HVDA22C3		
			 3400 700 461 ⊗ 3482 000 572 ⊗ 1878 004 132 ⊙ 3151 000 144	430 10 MFZ430 430WGTZ KZISZ-5	Getr. / GBox: 16S2220TO KVDA22A3		
AD 400T44 T, AT 400T44 T AD 400T44 WT, AT 400T44 WT	06.05- 06.05-	F3BE0681	 3400 117 801 ⊗ 3482 083 032 ⊗ 1878 085 741 ⊙ 3151 000 144	430 10 MFZ430 430WGTZ KZISZ-5	Getr. / GBox: 12AS2301OD KBMA21E1 / KBMA22E1 / KGMA23E2 / HBMA22E1 / HDMA22E1 / HDME22E1 / HGMA23E2		
			 3400 117 801 ⊗ 3482 083 032 ⊗ 1878 085 741 ⊙ 3151 000 144	430 10 MFZ430 430WGTZ KZISZ-5	Getr. / GBox: 16S181OD KBMA21B1 / KBMA22B1 / KBMA22B2 / KGMA23B2 / HBMA22B1 / HBMA22B2 / HDMA22B1 / HDME22B1 / HGMA23B2		



















		CODE				
--	--	------	--	---	---	---

IVECO

Trakker		10.04 -					
AD 400T45 T, AT 400T45 T AD 400T45 WT, AT 400T45 WT	03.06-	F3BE3681	 3400 700 366 ⊗ 3482 000 572 ⊗ 1878 004 132 ⊙ 3151 000 493	430 10 MFZ430 430WGTZ KZISZ-5	Getr. / GBox: 12AS2330TO KMEA22C1 / KVEA22C3 / HMEA22C1 / HVEA22C6 für Ausrückgabel mit Rollen / for release fork with rollers	(70)	
	03.06-		 3400 700 461 ⊗ 3482 000 572 ⊗ 1878 004 132 ⊙ 3151 000 144	430 10 MFZ430 430WGTZ KZISZ-5	Getr. / GBox: 12AS2330TO KMEA22C1 / HMEA22C1 / HVEA22C3		
			 3400 700 461 ⊗ 3482 000 572 ⊗ 1878 004 132 ⊙ 3151 000 144	430 10 MFZ430 430WGTZ KZISZ-5	Getr. / GBox: 16S2220TO KMEA22A1 / KVEA22A3 / HMEB22A1		
AD 400T50 T, AT 400T50 T	03.06-	F3BE3681	 3400 700 461 ⊗ 3482 000 572 ⊗ 1878 004 132 ⊙ 3151 000 144	430 10 MFZ430 430WGTZ KZISZ-5	Getr. / GBox: 12AS2330TO HMF22C1		
AD 410T36, AT 410T36	03.06-	F2BE3681	 3400 700 365 ⊗ 3482 000 573 ⊗ 1878 004 133 ⊙ 3151 000 493	430 10 MFZ430 430WGTZ KZISZ-5	Getr. / GBox: 12AS1930TD KTCC14CA für Ausrückgabel mit Rollen / for release fork with rollers	(70)	
AD 410T38 B, AT 410T38 B	06.05-	F3BE0681	 3400 117 801 ⊗ 3482 083 032 ⊗ 1878 085 741 ⊙ 3151 000 144	430 10 MFZ430 430WGTZ KZISZ-5	Getr. / GBox: 12AS2301OD KELD11E1 / KELD12E1 / KELD13E1 / KELD14E1 / HELD13E1 / HELD14E1		
			 3400 117 801 ⊗ 3482 083 032 ⊗ 1878 085 741 ⊙ 3151 000 144	430 10 MFZ430 430WGTZ KZISZ-5	Getr. / GBox: 16S1510D KELD11B1 / KELD11B2 / KELD12B1 / KELD13B1 / KELD13B2 / KELD14B1 / KELD71B1 / KELD72B1 / KELD73B1 / HELD13B1		
AD 410T44 B, AT 410T44 B	06.05-	F3BE0681	 3400 117 801 ⊗ 3482 083 032 ⊗ 1878 085 741 ⊙ 3151 000 144	430 10 MFZ430 430WGTZ KZISZ-5	Getr. / GBox: 12AS2301OD KEMD11E1 / KEMD12E1 / KEMD12E2 / KEMD13E1 / KEMD13EB / KEMD14E1 / KKMD12E2 / HEMD11E1 / HEMD12E1		
			 3400 117 801 ⊗ 3482 083 032 ⊗ 1878 085 741 ⊙ 3151 000 144	430 10 MFZ430 430WGTZ KZISZ-5	Getr. / GBox: 16S1810D KEMD11B1 / KEMD11B2 / KEMD12B1 / KEMD12B2 / KEMD13B1 / KEMD13B2 / KEMD13BA / KEMD14B1 / KEMD71B1 / KEMD71BA / KEMD72B1 / KEMD73B1 / KKMD12B2 / HEMD11B1 / HEMD12B1 / HEMD13B1		
AD 410T45 W AD 410T45 W AD 410T45, AT 410T45 AD 410T45, AT 410T45	03.06-	F3BE3681	 3400 700 366 ⊗ 3482 000 572 ⊗ 1878 004 132 ⊙ 3151 000 493	430 10 MFZ430 430WGTZ KZISZ-5	Getr. / GBox: 12AS2330TO KWEC13C3 / HTEC11C1 / KTEC11C1 / KTEC12C1 / KTEC12C4 / KTEC13C1 / KTEE14C4 / KWEC12C3 / KWEC12C6 für Ausrückgabel mit Rollen / for release fork with rollers	(70)	
	07.07-		 3400 700 461 ⊗ 3482 000 572 ⊗ 1878 004 132 ⊙ 3151 000 144	430 10 MFZ430 430WGTZ KZISZ-5	Getr. / GBox: 12AS2330TO KWEC13C3 / HTEC11C1 / KTEC11C1 / KTEC12C1 / KTEC13C1 / KWEC12C3		
	03.06-		 3400 700 461 ⊗ 3482 000 572 ⊗ 1878 004 132 ⊙ 3151 000 144	430 10 MFZ430 430WGTZ KZISZ-5	Getr. / GBox: 16S2220TO HTEC11A1 / HTEC13A1 / KTEC11A1 / KTEC12A1 / KTEC14A1 / KWEC12A3		
AD 410T48 B, AT 410T48 B	06.05-	F3BE0681	 3400 117 801 ⊗ 3482 083 032 ⊗ 1878 085 741 ⊙ 3151 000 144	430 10 MFZ430 430WGTZ KZISZ-5	Getr. / GBox: 12AS2301OD KESD11E1 / KESD12E1 / KESD13E1 / KESD14E1 / HESD11E1 / HESD12E1 / HESD13E1 / HESD14E1		
			 3400 117 801 ⊗ 3482 083 032 ⊗ 1878 085 741 ⊙ 3151 000 144	430 10 MFZ430 430WGTZ KZISZ-5	Getr. / GBox: 16S2210D KESD11B1 / KESD11B2 / KESD12B1 / KESD13B1 / KESD13B2 / KESD14B1 / HESD11B1 / HESD11B2 / HESD12B1 / HESD13B1 / HESD14B1 / HESD14B2		
AD 410T50, AT 410T50 AD 410T50, AT 410T50	03.06-	F3BE3681	 3400 700 366 ⊗ 3482 000 572 ⊗ 1878 004 132 ⊙ 3151 000 493	430 10 MFZ430 430WGTZ KZISZ-5	Getr. / GBox: 12AS2330TO KTFC11C1 / KTFC11C4 / KTFC14C4 / KTFE11C4 / HTFC11C1 / HTFC12C1 / HTFC14C1 / HTFE13C4 für Ausrückgabel mit Rollen / for release fork with rollers	(70)	
	06.06-		 3400 700 461 ⊗ 3482 000 572 ⊗ 1878 004 132 ⊙ 3151 000 144	430 10 MFZ430 430WGTZ KZISZ-5	Getr. / GBox: 12AS2330TO KTFC11C1 / HTFC11C1 / HTFC14C1		
			 3400 700 461 ⊗ 3482 000 572 ⊗ 1878 004 132 ⊙ 3151 000 144	430 10 MFZ430 430WGTZ KZISZ-5	Getr. / GBox: 16S2520TO KTFC11A1 / KTFC12A1 / KTFC13A1 / KTFC14A1 / HTFC11A1		
AD 440T38 T, AT 440T38 T	04.05-	F3BE0681	 3400 117 801 ⊗ 3482 083 032 ⊗ 1878 085 741 ⊙ 3151 000 144	430 10 MFZ430 430WGTZ KZISZ-5	Getr. / GBox: 16S1510D KDLE22B1		

		CODE				
--	--	------	--	---	---	---













IVECO

Trakker		10.04 -					
AD 440T41 T, AT 440T41 T	03.06-	F3BE3681	 3400 700 366 ⊗ 3482 000 572 ⊗ 1878 004 132 ⊙ 3151 000 493	430 10 MFZ430 430WGTZ KZISZ-5	Getr. / GBox: 12AS2330TO HQDB21CA / HQDE21C1 für Ausrückgabel mit Rollen / for release fork with rollers	(70)	
			 3400 700 461 ⊗ 3482 000 572 ⊗ 1878 004 132 ⊙ 3151 000 144	430 10 MFZ430 430WGTZ KZISZ-5	Getr. / GBox: 12AS2330TO HQDB21CA / HQDE21C1		
AD 440T44 B AD 440T44 T, AT 440T44T	06.05 - 06.05-	F3BE0681	 3400 117 801 ⊗ 3482 083 032 ⊗ 1878 085 741 ⊙ 3151 000 144	430 10 MFZ430 430WGTZ KZISZ-5	Getr. / GBox: 12AS2301OD KDMA22E1 / KDMA22EA / KDME22E1		
			 3400 117 801 ⊗ 3482 083 032 ⊗ 1878 085 741 ⊙ 3151 000 144	430 10 MFZ430 430WGTZ KZISZ-5	Getr. / GBox: 16S181OD KDMA22B1 / KDME22B1		
AD 440T45 T, AT 440T45 T	03.06-	F3BE3681	 3400 700 366 ⊗ 3482 000 572 ⊗ 1878 004 132 ⊙ 3151 000 493	430 10 MFZ430 430WGTZ KZISZ-5	Getr. / GBox: 12AS2330TO KQEB21C1 / HQEB21CA / HQEE21C1 für Ausrückgabel mit Rollen / for release fork with rollers	(70)	
			 3400 700 366 ⊗ 3482 000 572 ⊗ 1878 004 132 ⊙ 3151 000 493	430 10 MFZ430 430WGTZ KZISZ-5	Getr. / GBox: 16S2220TO KQEE21C1 für Ausrückgabel mit Rollen / for release fork with rollers	(70)	
			 3400 700 461 ⊗ 3482 000 572 ⊗ 1878 004 132 ⊙ 3151 000 144	430 10 MFZ430 430WGTZ KZISZ-5	Getr. / GBox: 12AS2330TO HQEB21CA / HQEE21C1		
AD 440T50 T, AT 440T50 T	03.06-	F3BE3681	 3400 700 366 ⊗ 3482 000 572 ⊗ 1878 004 132 ⊙ 3151 000 493	430 10 MFZ430 430WGTZ KZISZ-5	Getr. / GBox: 12AS2330TO HQFE21C1 für Ausrückgabel mit Rollen / for release fork with rollers	(70)	
			 3400 700 461 ⊗ 3482 000 572 ⊗ 1878 004 132 ⊙ 3151 000 144	430 10 MFZ430 430WGTZ KZISZ-5	Getr. / GBox: 12AS2330TO HQFE21C1		
			 3400 700 461 ⊗ 3482 000 572 ⊗ 1878 004 132 ⊙ 3151 000 144	430 10 MFZ430 430WGTZ KZISZ-5	Getr. / GBox: 16S2520TO KQFB21A1		
AD 720T38 T, AT 720T38 T AD 720T38 WT, AT 720T38 WT	06.05 - 06.05-	F3BE0681	 3400 117 801 ⊗ 3482 083 032 ⊗ 1878 085 741 ⊙ 3151 000 144	430 10 MFZ430 430WGTZ KZISZ-5	Getr. / GBox: 16S151OD K3UAH2B1 / K3UAH3B1 / K3UBH4B1 / KDLD22B1 / KJLD23B2 / H3UAH3B1 / H3UBH3B1 / H3UBH4B1 / HDLD22B1 / HDLD22B2		
			 3400 117 801 ⊗ 3482 083 032 ⊗ 1878 085 741 ⊙ 3151 000 144	430 10 MFZ430 430WGTZ KZISZ-5	Getr. / GBox: 12AS2301OD KDMD22E1 / KDMD22EA / KJMD23E2 / HDMD22E1 / HDMD22EA / HJMD23E2		
AD 720T44 T, AT 720T44 T AD 720T44 WT, AT 720T44 WT	06.05 - 06.05-	F3BE0681	 3400 117 801 ⊗ 3482 083 032 ⊗ 1878 085 741 ⊙ 3151 000 144	430 10 MFZ430 430WGTZ KZISZ-5	Getr. / GBox: 16S181OD KDMD22B1 / KDMD22B2 / KJMD23B2 / HDMD22B1 / HDMD22B2 / HJMD23B2		
			 3400 117 801 ⊗ 3482 083 032 ⊗ 1878 085 741 ⊙ 3151 000 144	430 10 MFZ430 430WGTZ KZISZ-5	Getr. / GBox: 12AS2330TO KREC21C1 / KZEC21C3 / HREC21C1 für Ausrückgabel mit Rollen / for release fork with rollers	(70)	
AD 720T45 T, AT 720T45 T AD 720T45 WT, AT 720T45 WT	03.06 - 03.06-	F3BE3681	 3400 700 366 ⊗ 3482 000 572 ⊗ 1878 004 132 ⊙ 3151 000 493	430 10 MFZ430 430WGTZ KZISZ-5	Getr. / GBox: 12AS2330TO HREC21C1 / HZEC21C3		
			 3400 700 461 ⊗ 3482 000 572 ⊗ 1878 004 132 ⊙ 3151 000 144	430 10 MFZ430 430WGTZ KZISZ-5	Getr. / GBox: 16S2220TO KREC21A1 / KZEC21A3		
			 3400 117 801 ⊗ 3482 083 032 ⊗ 1878 085 741 ⊙ 3151 000 144	430 10 MFZ430 430WGTZ KZISZ-5	Getr. / GBox: 12AS2301OD KDSD22E1 / HDSD22E1		
AD 720T48 T, AT 720T48 T	06.05 -	F3BE0681	 3400 117 801 ⊗ 3482 083 032 ⊗ 1878 085 741 ⊙ 3151 000 144	430 10 MFZ430 430WGTZ KZISZ-5	Getr. / GBox: 16S221OD KDSD22B1 / KDSD22B2 / HDSD22B1 / HDSD22B2		
			 3400 117 801 ⊗ 3482 083 032 ⊗ 1878 085 741 ⊙ 3151 000 144	430 10 MFZ430 430WGTZ KZISZ-5			















		CODE				
--	--	------	--	---	---	---

IVECO

Trakker 10.04 -















AD 720T50 T, AT 720T50 T, AT 720T50 TP	03.06-	F3BE3681	 3400 700 366  3482 000 572  1878 004 132  3151 000 493	430 10 MFZ430 430WGTZ KZISZ-5	Getr. / GBox: 12AS2330TO KRFC21C1 / HRFC21C1 / HRFE21C4 für Ausrückgabel mit Rollen / for release fork with rollers	(70)
			 3400 700 461  3482 000 572  1878 004 132  3151 000 144	430 10 MFZ430 430WGTZ KZISZ-5	Getr. / GBox: 12AS2330TO KRFC21C1 / HRFC21C1	
			 3400 700 461  3482 000 572  1878 004 132  3151 000 144	430 10 MFZ430 430WGTZ KZISZ-5	Getr. / GBox: 16S2520TO KRFC21A1 / HRFC21A1	

TurboStar 07.84 - 12.93

















190-33 190-33 T	07.84 - 09.86 07.84 - 09.86	8210.22.105	 3400 700 454 ■	430 10	->Chass. 140027 Getr. / GBox: Fuller Nabenprofil / Hub Profile: 41,1x50,8-10N Ausrückgabel hängend [mm] / Release Fork, suspended [mm]: 125	(46) (9)
			 3482 083 040	430 MFZ430	->Chass. 140027 Getr. / GBox: Fuller In 3483/3488 enthalten / Contained in 3483, 3488	(30)
			 3100 002 038  3151 123 031  3180 001 008	KZIZ5 KZIZ-5	09.1984 - Chass. 140027 Getr. / GBox: Fuller Beinhaltet Ausrücker und Montagesatz / Contains releaser and fitting kit In 3483/3488 enthalten / Contained in 3483, 3488	(14) (30)
			 3483 010 138 ⊕	430 GMFZ430	09.1984 - Chass. 140027 Getr. / GBox: Fuller Beinhaltet Ausrücker und Montagesatz / Contains releaser and fitting kit	(14)
			 1861 992 432	430 10 430GVZ	09.1984 - Chass. 140027 Getr. / GBox: Fuller	
			 3482 043 134	430 GMFZ430	09.1984 - Chass. 140027 Getr. / GBox: Fuller In 3483/3488 enthalten / Contained in 3483, 3488	(30)
			 3400 700 456 ■	430 10	Chass. 140028-> Getr. / GBox: Fuller Nabenprofil / Hub Profile: 41,1x50,8-10N Ausrückgabel stehend [mm] / Release Fork, upright [mm]: 86	(46) (10)
			 3400 700 457 ■	430 10	Chass. 140028-> Getr. / GBox: ZF Nabenprofil / Hub Profile: 41,1x50,8-10N	(46)
			 3482 083 040	430 MFZ430	Chass. 140028-> Getr. / GBox: ZF Getr. / GBox: Fuller In 3483/3488 enthalten / Contained in 3483, 3488	(30)
			 3100 002 040  3151 000 148  3180 001 008	KZIZ5	Chass. 140028-> Getr. / GBox: ZF Getr. / GBox: Fuller Beinhaltet Ausrücker und Montagesatz / Contains releaser and fitting kit In 3483/3488 enthalten / Contained in 3483, 3488	(14) (30)

		CODE				
--	--	------	--	---	---	---

IVECO

















TurboStar		07.84 - 12.93				
190-33 190-33 P 190-33 T	10.86 - 05.87	8210.22.105	 3400 700 454 ■	430 10	-> Chass. 140027 Getr. / GBox: Fuller Nabenprofil / Hub Profile: 41,1x50,8-10N Ausrückgabel hängend [mm] / Release Fork, suspended [mm]: 125	(46) (9)
	01.86 - 12.87		 3482 083 040	430 MFZ430	-> Chass. 140027 Getr. / GBox: Fuller In 3483/3488 enthalten / Contained in 3483, 3488	(30)
	10.86 - 05.87		 3100 002 038 ◊ 3151 123 031 ◎ 3180 001 008	KZIZ5 KZI/Z-5	-> Chass. 140027 Getr. / GBox: Fuller Beinhaltet Ausrücker und Montagesatz / Contains releaser and fitting kit In 3483/3488 enthalten / Contained in 3483, 3488	(14) (30)
			 3483 010 138 ⊕	430 GMFZ430	-> Chass. 140027 Getr. / GBox: Fuller Beinhaltet Ausrücker und Montagesatz / Contains releaser and fitting kit	(14)
			 1861 992 432	430 10 430GVZ	-> Chass. 140027 Getr. / GBox: Fuller	
			 3482 043 134	430 GMFZ430	-> Chass. 140027 Getr. / GBox: Fuller In 3483/3488 enthalten / Contained in 3483, 3488	(30)
			 3400 700 456 ■	430 10	Chass. 140028-> Getr. / GBox: Fuller Nabenprofil / Hub Profile: 41,1x50,8-10N Ausrückgabel stehend [mm] / Release Fork, upright [mm]: 86	(46) (10)
			 3400 700 457 ■	430 10	Chass. 140028-> Getr. / GBox: ZF Nabenprofil / Hub Profile: 41,1x50,8-10N	(46)
			 3482 083 040	430 MFZ430	Chass. 140028-> Getr. / GBox: Fuller Getr. / GBox: ZF In 3483/3488 enthalten / Contained in 3483, 3488	(30)
			 3100 002 040 ◊ 3151 000 148 ◎ 3180 001 008	KZIZ5	Chass. 140028-> Getr. / GBox: ZF Getr. / GBox: Fuller Beinhaltet Ausrücker und Montagesatz / Contains releaser and fitting kit In 3483/3488 enthalten / Contained in 3483, 3488	(14) (30)
190-36 190-36 190-36 P 190-36 P 190-36 T 190-36 T	07.87 - 06.90	8210	 3400 700 456 ■	430 10	Getr. / GBox: Fuller Nabenprofil / Hub Profile: 41,1x50,8-10N Ausrückgabel stehend [mm] / Release Fork, upright [mm]: 86	(46) (10)
	07.90 - 12.93		 3400 700 457 ■	430 10	Getr. / GBox: ZF Nabenprofil / Hub Profile: 41,1x50,8-10N	(46)
	07.87 - 06.90		 3482 083 040	430 MFZ430	Getr. / GBox: ZF Getr. / GBox: Fuller In 3483/3488 enthalten / Contained in 3483, 3488	(30)
	07.90 - 12.93		 3100 002 040 ◊ 3151 000 148 ◎ 3180 001 008	KZIZ5	Getr. / GBox: ZF Getr. / GBox: Fuller Beinhaltet Ausrücker und Montagesatz / Contains releaser and fitting kit In 3483/3488 enthalten / Contained in 3483, 3488	(14) (30)
	07.87 - 06.90					
07.90 - 12.93						





















IVECO

TurboStar		07.84 - 12.93				
190-42 190-42 T	07.84 - 09.86	8280	 3400 700 454 ■	430 10	->Chass. 140027 Getr. / GBox: Fuller Nabenprofil / Hub Profile: 41,1x50,8-10N Ausrückgabel hängend [mm] / Release Fork, suspended [mm]: 125	(46) (9)
	07.84 - 09.86		 3482 083 040	430 MFZ430	Getr. / GBox: Fuller In 3483/3488 enthalten / Contained in 3483, 3488	(30)
			 3100 002 038 ◊ 3151 123 031 ◎ 3180 001 008	KZIZ5 KZI/Z-5	->Chass. 140027 Getr. / GBox: Fuller Beinhaltet Ausrücker und Montagesatz / Contains releaser and fitting kit In 3483/3488 enthalten / Contained in 3483, 3488	(14) (30)
			 3400 700 456 ■	430 10	Chass. 140028-> Getr. / GBox: Fuller Nabenprofil / Hub Profile: 41,1x50,8-10N Ausrückgabel stehend [mm] / Release Fork, upright [mm]: 86	(46) (10)
			 3100 002 040 ◊ 3151 000 148 ◎ 3180 001 008	KZIZ5	Chass. 140028-> Getr. / GBox: Fuller Beinhaltet Ausrücker und Montagesatz / Contains releaser and fitting kit In 3483/3488 enthalten / Contained in 3483, 3488	(14) (30)
			 3400 700 457 ■	430 10	09.1984-> Getr. / GBox: ZF Nabenprofil / Hub Profile: 41,1x50,8-10N	(46)
			 3482 083 040	430 MFZ430	09.1984-> Getr. / GBox: ZF In 3483/3488 enthalten / Contained in 3483, 3488	(30)
			 3100 002 040 ◊ 3151 000 148 ◎ 3180 001 008	KZIZ5	09.1984-> Getr. / GBox: ZF Beinhaltet Ausrücker und Montagesatz / Contains releaser and fitting kit In 3483/3488 enthalten / Contained in 3483, 3488	(14) (30)
190-42 190-42 T	10.86 - 12.90	8280	 3400 700 454 ■	430 10	->Chass. 140027 Getr. / GBox: Fuller Nabenprofil / Hub Profile: 41,1x50,8-10N Ausrückgabel hängend [mm] / Release Fork, suspended [mm]: 125	(46) (9)
	10.86 - 12.90		 3100 002 038 ◊ 3151 123 031 ◎ 3180 001 008	KZIZ5 KZI/Z-5	->Chass. 140027 Getr. / GBox: Fuller Beinhaltet Ausrücker und Montagesatz / Contains releaser and fitting kit In 3483/3488 enthalten / Contained in 3483, 3488	(14) (30)
			 3400 700 456 ■	430 10	Chass. 140028-> Getr. / GBox: Fuller Nabenprofil / Hub Profile: 41,1x50,8-10N	(46)
			 3100 002 040 ◊ 3151 000 148 ◎ 3180 001 008	KZIZ5	Chass. 140028-> Getr. / GBox: Fuller Beinhaltet Ausrücker und Montagesatz / Contains releaser and fitting kit	(14)
			 3400 700 457 ■	430 10	Getr. / GBox: ZF Nabenprofil / Hub Profile: 41,1x50,8-10N	(46)
			 3482 083 040	430 MFZ430	Getr. / GBox: Fuller Getr. / GBox: ZF In 3483/3488 enthalten / Contained in 3483, 3488	(30)
			 3100 002 040 ◊ 3151 000 148 ◎ 3180 001 008	KZIZ5	Getr. / GBox: ZF Beinhaltet Ausrücker und Montagesatz / Contains releaser and fitting kit	(14)
190-48 190-48 190-48 T 190-48 T	03.89 - 03.91	8280.42.001, 8280.42.050	 3400 700 455 ■	430 10	Getr. / GBox: Fuller Nabenprofil / Hub Profile: 41,1x50,8-10N	(46)
	04.91 - 12.93		 3400 117 801 ◎ 3482 083 032 ◎ 1878 085 741 ◊ 3151 000 144	430 10 MFZ430 430WGTZ KZISZ-5	Getr. / GBox: ZF	
	03.89 - 03.91					
	04.91 - 12.93					

		CODE				
--	--	------	--	---	---	---

IVECO

























TurboTech		01.90 - 01.93						
190-26	01.90 - 12.92	8460		3482 085 033	420	-> Chass. 93115 Getr. / GBox: Fuller, ZF enthält Druckplattenbefestigungsschrauben / includes bolt for pressure plate mounting	(64)	
190-26 T	01.90 - 12.92				MF420			
190-32	01.90 - 12.92				1878 002 955	420 10	-> Chass. 93115 Getr. / GBox: Fuller, ZF	
190-32 T	01.90 - 12.92				3151 114 031	420GTZ		
					3482 125 131	420	Chass. 93116-> Getr. / GBox: Fuller, ZF enthält Druckplattenbefestigungsschrauben / includes bolt for pressure plate mounting	(64)
					1861 973 032 #	MF420		
			3151 207 031	420WGvZ	Chass. 93116-> Getr. / GBox: Fuller, ZF			
			3482 083 040	420WGvZ	Chass. 93116-> Getr. / GBox: Fuller, ZF			
190-36	01.90 - 12.92	8210		3400 700 456 ■	430 10	Getr. / GBox: Fuller Nabenprofil / Hub Profile: 41,1x50,8-10N Ausrückgabel stehend [mm] / Release Fork, upright [mm]: 86	(46) (10)	
190-36 T	01.90 - 12.92			3400 700 457 ■	430 10			Getr. / GBox: ZF Nabenprofil / Hub Profile: 41,1x50,8-10N
					3482 083 040	430	Getr. / GBox: Fuller Getr. / GBox: ZF In 3483/3488 enthalten / Contained in 3483, 3488	(30)
					3100 002 040	MFZ430		
			3151 000 148	KZIZ5	Getr. / GBox: Fuller Getr. / GBox: ZF Beinhaltet Ausrücker und Montagesatz / Contains releaser and fitting kit	(14)		
			3180 001 008		In 3483/3488 enthalten / Contained in 3483, 3488	(30)		
220-36 PT	01.90 - 12.92	8210		3400 700 456 ■	430 10	Getr. / GBox: Fuller Nabenprofil / Hub Profile: 41,1x50,8-10N	(46)	
240-36 P	01.90 - 12.92			3482 083 040	430			Getr. / GBox: Fuller In 3483/3488 enthalten / Contained in 3483, 3488
					3100 002 040	MFZ430	Getr. / GBox: Fuller Beinhaltet Ausrücker und Montagesatz / Contains releaser and fitting kit	(14)
			3151 000 148		In 3483/3488 enthalten / Contained in 3483, 3488	(30)		
			3180 001 008					

Zeta		01.79 - 12.92								
50-8	01.83 - 12.86	8040.25.230R, 8040.05.230, 8340.04.200, 8340.04.250, 8060.04.660, 8340.04.300, 8040.04.200, 8340.04.362, 8060.04.060		3400 700 347	310 10					
50-8 H	01.83 - 12.86				3482 125 245			MF310		
50-8 V	01.83 - 12.86				1878 000 611			310TB		
50-9	01.87 - 03.91				3151 600 540			KZA-4		
50-9 H	01.87 - 03.91				3482 911 001			270	Je nach Kundenwunsch mit unterschiedlicher Kupplung / Equipped with different clutch according to customer requirement	(33)
50-9 V	01.87 - 03.91				1862 811 001			MF270		
50-10	01.79 - 12.86				1878 600 834			270 10	Je nach Kundenwunsch mit unterschiedlicher Kupplung / Equipped with different clutch according to customer requirement	(33)
50-10 H	01.79 - 12.86				1878 600 834			270CTB		
50-10 V	01.79 - 12.86				1878 600 834			250 10	-> 08.1983	
60-11	01.87 - 03.91				1878 600 834			250CB		
60-11 V	01.87 - 03.91		1878 600 834	250 10	09.1983->					
79-13	11.79 - 12.83		1878 600 834	250CB						
79-13	11.79 - 12.83		1878 600 834	250 10	09.1983->					
79-13	11.79 - 12.83		1878 600 834	250CB						
60-8	11.79 - 12.83	8040.04.200		1878 600 834	250 10	09.1983->				
		Deutz		1878 600 834	280CTB					
60-8	11.79 - 12.82	8040.04.200		1878 600 834	250 10	09.1983->				
60-8	11.79 - 12.81			1878 600 841	H280					
60-10	11.79 - 12.86	8340		1882 806 001 ▲	280	09.1983->				
60-10 V	11.79 - 12.86				1878 600 841			280 10		
					1850 282 652			280CTB		
				1850 282 652	KZA-2	->02.1982				

		CODE		 Parameter		
--	--	------	--	---	---	---

IVECO

Zeta 01.79 - 12.92



60-10 H	11.79 - 12.86	8340		1882 806 001 ▲	280 H280	09.1983->
				1850 282 652	KZA-2	->02.1982
		8340.04.200, 8340.04.250		1878 600 841	280 10 280CTB	
65-9	01.87 - 03.91	8040		3482 911 001	270 MF270	
				1862 811 001	270 10 270CTB	
65-10 65-10 H 65-10 V	11.79 - 01.87 11.79 - 01.87 11.79 - 01.87	8340.04.350, 8340.04.200, 8340.04.250, 8340.04.300		1878 600 841	280 10 280CTB	
65-12 65-12 H 65-12 V 79-12 79-12 H 79-12 H 79-12 V 79-12 V	01.87 - 03.91 01.87 - 03.91 01.87 - 03.91 01.87 - 03.91 01.87 - 03.91 01.87 - 03.91 01.87 - 03.91 01.87 - 03.91	8040		3400 700 347  3482 125 245  1878 000 611  3151 600 540	310 10 MF310 310TB KZA-4	
79-10 79-10 79-10 H 79-10 H 79-10 V 79-10 V	01.83 - 01.87 01.83 - 01.87 01.83 - 01.87 01.83 - 01.87 01.83 - 01.87 01.83 - 01.87	8340		1882 806 001 ▲	280 H280	09.1983->
				1878 600 841	280 10 280CTB	
79-14 79-14 79-14 H 79-14 H 79-14 V 79-14 V	01.83 - 11.85 01.83 - 11.85 01.83 - 11.85 01.83 - 11.85 01.83 - 11.85 01.83 - 11.85	8060		3400 700 347  3482 125 245  1878 000 611  3151 600 540	310 10 MF310 310TB KZA-4	11.1984->
79-14 79-14 79-14 H 79-14 H 79-14 V 79-14 V 95-14 95-14 H 109-14 109-14 H	12.85 - 03.91 12.85 - 03.91 12.85 - 03.91 12.85 - 03.91 12.85 - 03.91 12.85 - 03.91 11.85 - 03.91 11.85 - 03.91 11.85 - 03.91 11.85 - 03.91	8060		3400 700 347  3482 125 245  1878 000 611  3151 600 540	310 10 MF310 310TB KZA-4	
95-14 95-14 H 109-14 109-14 H	07.83 - 10.85 07.83 - 10.85 06.83 - 12.85 06.83 - 12.85	8060		3400 700 347  3482 125 245  1878 000 611  3151 600 540	310 10 MF310 310TB KZA-4	09.1983->













60...







60 U-10 65 F	-02.82 -12.78	8340		1878 600 841	280 10 280CTB	
				1850 282 652	KZA-2	
65 NC 65 NC /70 NC 65 U-10 65/60 U-10	01.73 - 12.78 -10.78 -10.78	8340		1878 600 841	280 10 280CTB	













		CODE				
--	--	------	--	---	---	---

IVECO

60...						
65-12 A Fire Fighting	01.89-	F6L913		3482 008 033	310 MF310	
				1861 577 037 #	310 10 310GTD	
				3151 199 001	KZIS-3	











70...						
70 NC 70 NC /75 NC 70 U-10 75 NC 79 U-10	01.75-12.78 -10.78	8340		1878 600 841	280 10 280CTB	
				1878 600 841	280 10 280CTB	
				1878 600 841	280 10 280CTB	
70-10 (Mot. Deutz) 70-10 70-10 (Mot. Deutz)	01.73-12.78 01.73-12.75 -12.75			1878 600 841	280 10 280CTB	
				1878 600 841	280 10 280CTB	
				1850 282 652	KZA-2	
70-10 75 F 10/79 F 10 75 U-10 75-10	01.78- -02.82 -02.82	8340		1878 600 841	280 10 280CTB	
				1850 282 652	KZA-2	
				1850 282 652	KZA-2	
75-13 AW 75-13 AWM	01.87-	BF6L913T		3482 008 033	310 MF310	
				1861 577 037 #	310 10 310GTD	
				3151 199 001	KZIS-3	













90...						
90 NC	01.75-	Deutz		1878 600 841	280 10 280CTB	
90-13 AT		BF6L913T		3482 008 036 #	310 MF310	
				1861 577 136 #	310 10 310GTD	
				3151 199 001	KZIS-3	
90-16 AW		BF6L913		3482 038 031	350 GMF350	
				1861 742 032	350 10 350GTB	
				3151 199 001	KZIS-3	

110...						
110-14 P 4x4		8060		3482 125 245	310 MF310	Getr. / GBox: ZF
				1878 000 611	310 10 310TB	Getr. / GBox: ZF
				3151 824 001	KZA-4	Getr. / GBox: ZF
110-16 AW 110-16 AWM 110-17 AWM	01.84- 01.84-	BF6L913		3482 038 031	350 GMF350	
				1861 742 032	350 10 350GTB	
				3151 199 001	KZIS-3	
115-14		8060		3400 700 347	310 10	Getr. / GBox: Fiat
				3482 125 245	MF310	
				1878 000 611	310TB	
				3151 600 540	KZA-4	
				3482 125 245	310 MF310	Getr. / GBox: ZF
	1878 000 611	310 10 310TB	Getr. / GBox: ZF			
	3151 824 001	KZA-4	Getr. / GBox: ZF			

		CODE					
--	--	------	--	--	---	---	---



IVECO

120...							
120 PC 17 120-17 H 120-17 HW				3482 038 031	350 GMF350	für / for: Version 42231628 für / for: Version 42231929	(68) (68)
				1861 742 032	350 10 350GTB	für / for: Version 42231628 für / for: Version 42231929	(68) (68)
				3151 196 031	KZIS-4	für / for: Version 42231628 für / for: Version 42231929	(68) (68)
120-13 AN				1881 096 444 ▲	280 HV280		
				1861 479 032 #	295 10 295GSZ		
				3151 199 001	KZIS-3		
120-14	02.78 -	8360		3482 905 001	330 MF330		
120-25 AW	01.88 -	F8L413F		1882 325 139	380 G380		
				1878 000 957	380 10 380GTZ		
				3151 000 515	KZIS-4		

130...							
130-13 AN				1861 479 032 #	295 10 295GSZ		
				3151 199 001	KZIS-3		
130-16 AT		BF6L913		3482 038 031	350 GMF350		
				1861 742 032	350 10 350GTB		
				3151 199 001	KZIS-3		
135-14 ,H		8060		3400 700 347	310 10 MF310	Getr. / GBox: Fiat	
				3482 125 245	310TB		
				1878 000 611	KZA-4		
				3151 600 540			
				3482 125 245	310 MF310	Getr. / GBox: ZF	
				1878 000 611	310 10 310TB	Getr. / GBox: ZF	
				3151 824 001	KZA-4	Getr. / GBox: ZF	































140...							
140-14		8360		3482 905 001	330 MF330		
140-19				3482 002 234	350 GMF350X		
				1878 001 070	350 10 350GTZ		
				3151 000 515	KZIS-4		

150...							
150-14	02.78 -	8360		3482 905 001	330 MF330		
150-17 2. Serie	02.78 -	8360		3482 038 031	350 GMF350	Getr. / GBox: ZF	
				1861 742 032	350 10 350GTB	Getr. / GBox: ZF	
				3151 196 031	KZIS-4	Getr. / GBox: ZF	

160...							
160-16 A	02.78 -	BF6L913		3482 038 031	350 GMF350	Getr. / GBox: ZF	
				1861 742 032	350 10 350GTB	Getr. / GBox: ZF	
				3151 000 395	KZIS-4	Getr. / GBox: ZF	







		CODE				
--	--	------	--	---	---	---























IVECO

160...						
160-19 ANW				3482 002 234	350 GMF350X	
				1878 001 070	350 10 350GTZ	
				3151 000 515	KZIS-4	
160-26 ,T		8210		3482 125 131	420 MF420	Getr. / GBox: Fiat enthält Druckplattenbefestigungsschrauben / includes bolt for pressure plate mounting (64)
				1878 001 138	420 10 420GTZ	Getr. / GBox: Fiat
				3151 071 032	KZI-4,5	Getr. / GBox: Fiat
165-24 , T		8460		1882 325 139	380 G380	
				1878 000 957	380 10 380GTZ	
				3151 114 031	KZI-4,5	Getr. / GBox: ZF
				3151 127 031	KZI-4,5	Getr. / GBox: Fuller
170...						
170 NC 26				3400 119 001 ☹ 3482 085 033 1878 001 138 1874 015 200	420 10 MF420 420GTZ	enthält Druckplattenbefestigungsschrauben / includes bolt for pressure plate mounting (64)
				3151 054 031	KZI-4,5	
170 NC 33, 35 170 NT 33 170-32 170-33 170-35				3482 125 131	420 MF420	enthält Druckplattenbefestigungsschrauben / includes bolt for pressure plate mounting (64)
				1878 002 955	420 10 420GTZ	
170-26	01.79 -			3482 125 131	420 MF420	enthält Druckplattenbefestigungsschrauben / includes bolt for pressure plate mounting (64)
				1878 001 138	420 10 420GTZ	
				3151 071 032	KZI-4,5	Getr. / GBox: Fiat
				3151 127 031	KZI-4,5	Getr. / GBox: ZF
170-26	- 12.78			3400 119 001 ☹ 3482 085 033 1878 001 138 1874 015 200	420 10 MF420 420GTZ	enthält Druckplattenbefestigungsschrauben / includes bolt for pressure plate mounting (64)
				3151 071 032	KZI-4,5	Getr. / GBox: Fiat
				3151 127 031	KZI-4,5	Getr. / GBox: ZF
				3400 042 031 ☹ 3482 125 131 1878 002 955 1874 015 200	420 10 MF420 420GTZ	Getr. / GBox: Fuller enthält Druckplattenbefestigungsschrauben / includes bolt for pressure plate mounting (64)
170-30	01.79 -			3151 127 031	KZI-4,5	Getr. / GBox: Fuller
				3400 042 031 ☹ 3482 125 131 1878 002 955 1874 015 200	420 10 MF420 420GTZ	Getr. / GBox: Fuller enthält Druckplattenbefestigungsschrauben / includes bolt for pressure plate mounting (64)
170-35 ,T				3400 042 031 ☹ 3482 125 131 1878 002 955 1874 015 200	420 10 MF420 420GTZ	enthält Druckplattenbefestigungsschrauben / includes bolt for pressure plate mounting (64)
				3151 127 031	KZI-4,5	
				1882 325 139	380 G380	
180-24 , T		8220		1878 000 957	380 10 380GTZ	
				3151 114 031	KZI-4,5	Getr. / GBox: ZF
				3151 127 031	KZI-4,5	Getr. / GBox: Fuller
				1882 325 139	380 G380	

		CODE				
--	--	------	--	---	---	---



































IVECO

180...							
180-26		8210		3400 119 001 ☹ ⊗ 3482 085 033 ⊗ 1878 001 138 ⊣ 1874 015 200	420 10 MF420 420GTZ	enthält Druckplattenbefestigungsschrauben / includes bolt for pressure plate mounting	(64)
				3151 054 031	KZI-4,5	Getr. / GBox: Fiat	
				3482 125 131	420 MF420	Getr. / GBox: Fuller enthält Druckplattenbefestigungsschrauben / includes bolt for pressure plate mounting	(64)
				1878 001 138	420 10 420GTZ	Getr. / GBox: Fuller	
190 NC /H 26		8210		3400 119 001 ☹ ⊗ 3482 085 033 ⊗ 1878 001 138 ⊣ 1874 015 200	420 10 MF420 420GTZ	enthält Druckplattenbefestigungsschrauben / includes bolt for pressure plate mounting	(64)
				3151 054 031	KZI-4,5	Getr. / GBox: Fiat	
				3151 127 031	KZI-4,5	Getr. / GBox: Fuller	

190...							
190 NC 26 190 NC 30 190 U 26 190-33 190-35				3482 125 131	420 MF420	enthält Druckplattenbefestigungsschrauben / includes bolt for pressure plate mounting	(64)
				1878 002 955	420 10 420GTZ		
190 NT /H 26 190 PAC 190 PAC 26 190 PAT 190 U 26/T/TH 190-26	10.78-	8210		3400 119 001 ☹ ⊗ 3482 085 033 ⊗ 1878 001 138 ⊣ 1874 015 200	420 10 MF420 420GTZ	enthält Druckplattenbefestigungsschrauben / includes bolt for pressure plate mounting	(64)
				3151 054 031	KZI-4,5	Getr. / GBox: Fiat	
				3151 127 031	KZI-4,5	Getr. / GBox: Fuller	
190 PAC /F 20 190 PAC /H 20 190 PAC /20	01.76- 01.76- 01.76-			1882 325 134	380 G380		
				1878 000 957	380 10 380GTZ		
190 PAC 20 190-20 N		8220		1882 325 134	380 G380	Getr. / GBox: ZF	
				1878 000 957	380 10 380GTZ	Getr. / GBox: ZF	
				3151 000 515	KZIS-4	Getr. / GBox: ZF	
190 PAT 26 190 PC 26 4x2, 4x4 190 PT 26 4x2 190-26 H, HT, HW 190-26 N, NT, NW		8210		3400 119 001 ☹ ⊗ 3482 085 033 ⊗ 1878 001 138 ⊣ 1874 015 200	420 10 MF420 420GTZ	Getr. / GBox: Fiat, ZF enthält Druckplattenbefestigungsschrauben / includes bolt for pressure plate mounting	(64)
				3151 000 515	KZIS-4	Getr. / GBox: Fiat, ZF	
190 PC 190-35 H/HT		8280		3400 042 031 ☹ ⊗ 3482 125 131 ⊗ 1878 002 955 ⊣ 1874 015 200	420 10 MF420 420GTZ	Getr. / GBox: Fiat enthält Druckplattenbefestigungsschrauben / includes bolt for pressure plate mounting	(64)
				3151 000 515	KZIS-4	Getr. / GBox: Fiat	
190 PC 30		8210		3482 125 131	420 MF420	Getr. / GBox: Fuller enthält Druckplattenbefestigungsschrauben / includes bolt for pressure plate mounting	(64)
				3151 000 515	KZIS-4	Getr. / GBox: Fuller	
190 U T 190-30 P, T, PT	-09.80 -12.84	8210		3400 042 031 ☹ ⊗ 3482 125 131 ⊗ 1878 002 955 ⊣ 1874 015 200	420 10 MF420 420GTZ	enthält Druckplattenbefestigungsschrauben / includes bolt for pressure plate mounting	(64)
				3151 114 031	KZI-4,5	Getr. / GBox: ZF	
				3151 127 031	KZI-4,5	Getr. / GBox: Fuller	
190-24		8220		1882 325 139	380 G380	Getr. / GBox: Fuller	
				1878 000 957	380 10 380GTZ	Getr. / GBox: Fuller	
				3151 127 031	KZI-4,5	Getr. / GBox: Fuller	



























		CODE				
--	--	------	--	---	---	---

IVECO

190...						
190-25 A, AT	-12.84	F8L413F	 1882 325 139	380 G380	Getr. / GBox: Fuller	
			 1878 000 957	380 10 380GTZ	Getr. / GBox: Fuller	
			 3151 127 031	KZI-4,5	Getr. / GBox: Fuller	
190-26 , T	-12.84	8210	 3482 125 131	420 MF420	Getr. / GBox: Fuller enthält Druckplattenbefestigungsschrauben / includes bolt for pressure plate mounting	(64)
			 1878 001 138	420 10 420GTZ	Getr. / GBox: Fuller	
			 3151 127 031	KZI-4,5	Getr. / GBox: Fuller	
190-29 A,AP 190-29 AT, APT		BF8L413F	 3482 124 533 #	420 GMF430		
			 1878 002 955	420 10 420GTZ		
			 3151 127 031	KZI-4,5		
190-30 AHT		BF8L513	 3482 124 533 #	420 GMF430		
			 1878 002 955	420 10 420GTZ		
			 3151 000 515	KZIS-4		
190-30 P, T, PT	01.85 -		 3482 125 131	420 MF420	Getr. / GBox: Ecosplit 16 S 130 enthält Druckplattenbefestigungsschrauben / includes bolt for pressure plate mounting	(64)
			 1861 973 032 #	420 10 420WGVZ	Getr. / GBox: Ecosplit 16 S 130	
			 3151 114 031	KZI-4,5	Getr. / GBox: Ecosplit 16 S 130	
	8210	 3400 042 031	420 10 MF420 420GTZ	Getr. / GBox: Fuller enthält Druckplattenbefestigungsschrauben / includes bolt for pressure plate mounting	(64)	
		 1878 001 138	420 10 420GTZ	Getr. / GBox: Fuller		
		 3151 114 031	KZI-4,5	Getr. / GBox: Fuller		
190-32	01.87 -	8210	 3483 020 034	430 MFZ430		
			 1878 085 742	430 10 430WGTZ	Lose Kupplungsscheibe / Loose clutch disc	(39)
			 3482 083 040	430 MFZ430	In 3483/3488 enthalten / Contained in 3483, 3488	(30)
			 3100 002 040	KZIZ5	Beinhaltet Ausrücker und Montagesatz / Contains releaser and fitting kit	(14)
190-32 A, AT		BF8L413F	 3482 124 532	430 GMF430		
			 1878 002 955	420 10 420GTZ		
			 3151 000 515	KZIS-4		
190-32 AH, AHT, AHW		BF8L413F	 3482 124 533 #	420 GMF430		
			 1878 002 955	420 10 420GTZ		
			 3151 000 515	KZIS-4		
190-33	09.84 -		 3483 010 137	430 GMFZ430	->Chass. 140027 Getr. / GBox: ZF Beinhaltet Ausrücker und Montagesatz / Contains releaser and fitting kit	(14)
			 1878 022 841	430 10 430GTZ	->Chass. 140027 Getr. / GBox: ZF	
			 3482 043 134	430 GMFZ430	->Chass. 140027 Getr. / GBox: ZF In 3483/3488 enthalten / Contained in 3483, 3488	(30)
			 3100 002 040	KZIZ5	->Chass. 140027 Getr. / GBox: ZF Beinhaltet Ausrücker und Montagesatz / Contains	(14)
			 3151 000 148			
			 3180 001 008			



























		CODE					
--	--	------	--	--	---	---	---

IVECO







190...							
190-35 , T	-12.84	8280		3400 042 031 ☉ ⊗ 3482 125 131 ⊗ 1878 002 955 ⊗ 1874 015 200	420 10 MF420 420GTZ	Getr. / GBox: Fuller enthält Druckplattenbefestigungsschrauben / includes bolt for pressure plate mounting	(64)
				1878 001 138 ●	420 10 420GTZ	Getr. / GBox: Fuller	
				3151 127 031	KZI-4,5	Getr. / GBox: Fuller	
190-35 , T				3400 042 031 ☉ ⊗ 3482 125 131 ⊗ 1878 002 955 ⊗ 1874 015 200	420 10 MF420 420GTZ	Getr. / GBox: Fuller enthält Druckplattenbefestigungsschrauben / includes bolt for pressure plate mounting	(64)
				3151 127 031	KZI-4,5	Getr. / GBox: Fuller	
				3482 124 533 #	420 GMF430	Getr. / GBox: Fuller	
190-36 APT	-12.84	BF10L413F		1878 002 955	420 10 420GTZ	Getr. / GBox: Fuller	
				3151 127 031	KZI-4,5	Getr. / GBox: Fuller	
				3400 700 456 ■	430 10	Getr. / GBox: Fuller Nabenprofil / Hub Profile: 41,1x50,8-10N Ausrückgabel stehend [mm] / Release Fork, upright [mm]: 86	(46) (10)
190-38 , T, P, PT	01.87 -	8280		3482 083 040	430 MFZ430	Getr. / GBox: Fuller In 3483/3488 enthalten / Contained in 3483, 3488	(30)
				3100 002 040 ⊗ 3151 000 148 ⊗ 3180 001 008	KZIZ5	Getr. / GBox: Fuller Beinhaltet Ausrücker und Montagesatz / Contains releaser and fitting kit In 3483/3488 enthalten / Contained in 3483, 3488	(14) (30)
				3400 700 457 ■	430 10	Getr. / GBox: ZF Nabenprofil / Hub Profile: 41,1x50,8-10N	(46)
190-38 Turbo Star	01.87 -	8280		3482 083 040	430 MFZ430	Getr. / GBox: ZF In 3483/3488 enthalten / Contained in 3483, 3488	(30)
				3100 002 040 ⊗ 3151 000 148 ⊗ 3180 001 008	KZIZ5	Getr. / GBox: ZF Beinhaltet Ausrücker und Montagesatz / Contains releaser and fitting kit In 3483/3488 enthalten / Contained in 3483, 3488	(14) (30)
				3400 117 801 ⊗ 3482 083 032 ⊗ 1878 085 741 ⊗ 3151 000 144	430 10 MFZ430 430WGTZ KZISZ-5		
200...							
200-32				3482 125 131	420 MF420	enthält Druckplattenbefestigungsschrauben / includes bolt for pressure plate mounting	(64)
				1878 002 955	420 10 420GTZ		
200-32 AHW, AHWM		F10L413F		3482 124 534	430 GMF430	Getr. / GBox: ZF	
				1882 301 239 ●	420 GF420	Getr. / GBox: ZF	
				1878 634 017	420 10 420GSZ	Getr. / GBox: ZF	
				3151 000 515	KZIS-4	Getr. / GBox: ZF	
220...							
220-29 AP		BF8L413F		3482 124 533 #	420 GMF430	Getr. / GBox: Fuller	
				1878 002 955	420 10 420GTZ	Getr. / GBox: Fuller	
				3151 127 031	KZI-4,5	Getr. / GBox: Fuller	
220-30 PT	01.85 -	8210		3400 042 031 ☉ ⊗ 3482 125 131 ⊗ 1878 002 955 ⊗ 1874 015 200	420 10 MF420 420GTZ	Getr. / GBox: Fuller enthält Druckplattenbefestigungsschrauben / includes bolt for pressure plate mounting	(64)
				1878 001 138 ●	420 10 420GTZ	Getr. / GBox: Fuller	
				3151 114 031	KZI-4,5	Getr. / GBox: Fuller	

		CODE				
--	--	------	--	---	---	---

IVECO









































220...						
220-32 AHW, AHTM		F10L413F	 3482 124 534	430 GMF430	Getr. / GBox: ZF	
			 1882 301 239 ●	420 GF420	Getr. / GBox: ZF	
			 1878 634 017	420 10 420GSZ	Getr. / GBox: ZF	
			 3151 000 515	KZIS-4	Getr. / GBox: ZF	
220-35 T			 3400 042 031 ☹  3482 125 131  1878 002 955  1874 015 200	420 10 MF420 420GTZ	Getr. / GBox: Fuller enthält Druckplattenbefestigungsschrauben / includes bolt for pressure plate mounting	(64)
			 1878 001 138 ●	420 10 420GTZ	Getr. / GBox: Fuller	
			 3151 114 031	KZI-4,5	Getr. / GBox: Fuller	
220-36 AP, APT 220-38 PT	- 12.84 - 12.84		 3483 020 034 ⊕	430 MFZ430	Getr. / GBox: Fuller	
			 1861 992 432	430 10 430GVZ	Getr. / GBox: Fuller	
			 3482 083 040	430 MFZ430	Getr. / GBox: Fuller In 3483/3488 enthalten / Contained in 3483, 3488	(30)
			 3100 002 040  3151 000 148  3180 001 008	KZIZ5	Getr. / GBox: Fuller Beinhaltet Ausrücker und Montagesatz / Contains releaser and fitting kit In 3483/3488 enthalten / Contained in 3483, 3488	(14) (30)
220-38 PT		8280	 3400 700 456 ■	430 10	Getr. / GBox: Fuller Nabenprofil / Hub Profile: 41,1x50,8-10N Ausrückgabel stehend [mm] / Release Fork, upright [mm]: 86	(46) (10)
			 3482 083 040	430 MFZ430	Getr. / GBox: Fuller In 3483/3488 enthalten / Contained in 3483, 3488	(30)
			 3400 700 454 ■	430 10	Getr. / GBox: Fuller Nabenprofil / Hub Profile: 41,1x50,8-10N Ausrückgabel stehend [mm] / Release Fork, upright [mm]: 86 Ausrückgabel hängend [mm] / Release Fork, suspended [mm]: 125	(46) (10) (9)
			 3100 002 038  3151 123 031  3180 001 008	KZIZ5 KZI/Z-5	Getr. / GBox: Fuller Beinhaltet Ausrücker und Montagesatz / Contains releaser and fitting kit In 3483/3488 enthalten / Contained in 3483, 3488	(14) (30)
			 3400 700 457 ■	430 10	Getr. / GBox: ZF Nabenprofil / Hub Profile: 41,1x50,8-10N	(46)
			 3482 083 040	430 MFZ430	Getr. / GBox: ZF Getr. / GBox: Fuller In 3483/3488 enthalten / Contained in 3483, 3488	(30)
			 3100 002 040  3151 000 148  3180 001 008	KZIZ5	Getr. / GBox: ZF Getr. / GBox: Fuller Beinhaltet Ausrücker und Montagesatz / Contains releaser and fitting kit In 3483/3488 enthalten / Contained in 3483, 3488	(14) (30)

229...						
229			 1878 600 834	250 10 250CB		

230...						
230-26		8210	 3400 119 001 ☹  3482 085 033  1878 001 138  1874 015 200	420 10 MF420 420GTZ	enthält Druckplattenbefestigungsschrauben / includes bolt for pressure plate mounting	(64)
			 3151 054 031	KZI-4,5	Getr. / GBox: Fiat	
230-32			 3482 125 131	420 MF420	enthält Druckplattenbefestigungsschrauben / includes bolt for pressure plate mounting	(64)
			 1878 002 955	420 10 420GTZ		































		CODE				
--	--	------	--	---	---	---

IVECO

240...						
240-26		8210	 3482 125 131	420 MF420	enthält Druckplattenbefestigungsschrauben / includes bolt for pressure plate mounting	(64)
			 1878 001 138	420 10 420GTZ		
			 3151 127 031	KZI-4,5	Getr. / GBox: Fiat	
240-30	01.85 -	8210	 3400 042 031  3482 125 131  1878 002 955  1874 015 200	420 10 MF420 420GTZ	Getr. / GBox: Fuller enthält Druckplattenbefestigungsschrauben / includes bolt for pressure plate mounting	(64)
			 1878 001 138 ●	420 10 420GTZ	Getr. / GBox: Fuller	
			 1861 973 032 #	420 10 420WGVZ	Getr. / GBox: ZF16 S130	
			 3151 114 031	KZI-4,5	Getr. / GBox: Fuller Getr. / GBox: ZF16 S130	
240-30 P	- 12.84	8210	 3400 042 031  3482 125 131  1878 002 955  1874 015 200	420 10 MF420 420GTZ	Getr. / GBox: Fuller enthält Druckplattenbefestigungsschrauben / includes bolt for pressure plate mounting	(64)
			 3151 127 031	KZI-4,5	Getr. / GBox: Fuller	
240-36 Turbo Star 240-48 Turbo Star	01.89 - 01.89 -	8280	 3400 117 801  3482 083 032  1878 085 741  3151 000 144	430 10 MFZ430 430WGTZ KZISZ-5	Getr. / GBox: ZF	
			 3400 700 455 ■	430 10	Getr. / GBox: Fuller Nabenprofil / Hub Profile: 41,1x50,8-10N	(46)
			 1878 085 741 ●	430 10 430WGTZ	Getr. / GBox: ZF	
240-38	01.85 -	8280	 3400 700 456 ■	430 10	Getr. / GBox: Fuller Nabenprofil / Hub Profile: 41,1x50,8-10N Ausrückgabel stehend [mm] / Release Fork, upright [mm]: 86	(46) (10)
			 3100 002 040  3151 000 148  3180 001 008	KZIZ5	Getr. / GBox: Fuller Beinhaltet Ausrücker und Montagesatz / Contains releaser and fitting kit In 3483/3488 enthalten / Contained in 3483, 3488	(14) (30)
			 3400 700 454 ■	430 10	Getr. / GBox: Fuller Nabenprofil / Hub Profile: 41,1x50,8-10N Ausrückgabel hängend [mm] / Release Fork, suspended [mm]: 125	(46) (9)
			 3100 002 038  3151 123 031  3180 001 008	KZIZ5 KZI/Z-5	Getr. / GBox: Fuller Beinhaltet Ausrücker und Montagesatz / Contains releaser and fitting kit In 3483/3488 enthalten / Contained in 3483, 3488	(14) (30)
			 3400 700 457 ■	430 10	Getr. / GBox: ZF Nabenprofil / Hub Profile: 41,1x50,8-10N	(46)
			 3482 083 040	430 MFZ430	Getr. / GBox: ZF Getr. / GBox: Fuller In 3483/3488 enthalten / Contained in 3483, 3488	(30)
			 3100 002 040  3151 000 148  3180 001 008	KZIZ5	Getr. / GBox: ZF Beinhaltet Ausrücker und Montagesatz / Contains releaser and fitting kit In 3483/3488 enthalten / Contained in 3483, 3488	(14) (30)
			 3483 020 034 ⊕	430 MFZ430	Getr. / GBox: Fuller	
240-38 P	- 12.84		 1861 992 432	430 10 430GVZ	Getr. / GBox: Fuller Lose Kupplungsscheibe / Loose clutch disc	(39)
			 3482 083 040	430 MFZ430	Getr. / GBox: Fuller In 3483/3488 enthalten / Contained in 3483, 3488	(30)
			 3100 002 040  3151 000 148  3180 001 008	KZIZ5	Getr. / GBox: Fuller Beinhaltet Ausrücker und Montagesatz / Contains releaser and fitting kit In 3483/3488 enthalten / Contained in 3483, 3488	(14) (30)









		CODE				
--	--	------	--	---	---	---

















IVECO







260...						
260-23				1882 325 134	380 G380	
				1878 000 104	380 10 380GTZ	
				3151 000 395	KZIS-4	
260-23 AH 260-23 AHB 260-25 AHB	01.86 - 01.89 -	F8L413F		3482 124 531	430 GMF430	Getr. / GBox: ZF
				1882 316 035 ●#	420 GF420	Getr. / GBox: ZF
				1878 001 138	420 10 420GTZ	Getr. / GBox: ZF
				3151 000 515	KZIS-4	Getr. / GBox: ZF
260-23 AH	- 12.85	F8L413F		1882 325 139	380 G380	Getr. / GBox: ZF
				1878 000 957	380 10 380GTZ	Getr. / GBox: ZF
				3151 000 515	KZIS-4	Getr. / GBox: ZF
260-26 H, HT, HW 260-26 N, NW 260 PAC 26 6x4, 6x6 260 PC 6x4, 6x6 260 PT 26 6x4		8210		3400 119 001 ☉ ⊗ 3482 085 033 ⊗ 1878 001 138 ⊗ 1874 015 200	420 10 MF420 420GTZ	enthält Druckplattenbefestigungsschrauben / includes bolt for pressure plate mounting (64)
				3151 000 515	KZIS-4	
260-30				1882 345 101	420 G420XN	für Nebenantrieb / for PTO (82)
				1878 003 274	420 10 420GTZ	für Nebenantrieb / for PTO (82)
260-30 H		8210		3400 118 901 ☉ ⊗ 3482 125 131 ⊗ 1878 003 661 ⊗ 1874 015 200	420 10 MF420 420WGTZ	enthält Druckplattenbefestigungsschrauben / includes bolt for pressure plate mounting (64)
				3151 000 515	KZIS-4	
260-32		F10L413F		1882 306 242	420 G420N	Nebenantriebs-ID / PTO ID: 110E (48)
				1878 003 274	420 10 420GTZ	Nebenantriebs-ID / PTO ID: 110E (48)
260-32 AH		F8L413F		3482 124 533 #	420 GMF430	Getr. / GBox: Fuller
				1878 002 955	420 10 420GTZ	Getr. / GBox: Fuller
				3151 000 515	KZIS-4	Getr. / GBox: Fuller
260-32 AHM 260-32 AHWM		F10L413F		3482 124 534	430 GMF430	Getr. / GBox: ZF
				1882 301 239 ●	420 GF420	Getr. / GBox: ZF
				1878 634 017	420 10 420GSZ	Getr. / GBox: ZF
				3151 000 515	KZIS-4	Getr. / GBox: ZF
260-35 H, HT 6x4 260-35 HW 6x6 260 PC HW 6x6 260 PT 35 6x4, 6x6		8280		3400 042 031 ☉ ⊗ 3482 125 131 ⊗ 1878 002 955 ⊗ 1874 015 200	420 10 MF420 420GTZ	enthält Druckplattenbefestigungsschrauben / includes bolt for pressure plate mounting (64)
				3151 000 515	KZIS-4	
260-36				3400 700 456 ■	430 10	Getr. / GBox: Fuller Nabenprofil / Hub Profile: 41,1x50,8-10N (46)
				3400 700 457 ■	430 10	Getr. / GBox: ZF Nabenprofil / Hub Profile: 41,1x50,8-10N (46)
				3482 083 040	430 MFZ430	Getr. / GBox: Fuller Getr. / GBox: ZF In 3483/3488 enthalten / Contained in 3483, 3488 (30)
				3100 002 040 ⊗ 3151 000 148 ⊗ 3180 001 008	KZIZ5	Getr. / GBox: Fuller Getr. / GBox: ZF Beinhaltet Ausrücker und Montagesatz / Contains releaser and fitting kit (14) In 3483/3488 enthalten / Contained in 3483, 3488 (30)

		CODE				
--	--	------	--	---	---	---

IVECO

















































260...						
260-48 Turbo Star	01.89-	8280	 3400 117 801  3482 083 032  1878 085 741  3151 000 144	430 10 MFZ430 430WGTZ KZISZ-5	Getr. / GBox: ZF	
			 3400 700 455 ■	430 10	Getr. / GBox: Fuller Nabenprofil / Hub Profile: 41,1x50,8-10N	(46)
260 N, C, T			 3482 042 041	430 GM430		
260 PAC 260 PAT		8210	 3482 085 033	420 MF420	enthält Druckplattenbefestigungsschrauben / includes bolt for pressure plate mounting	(64)
			 1878 001 138	420 10 420GTZ		
			 3151 000 515	KZIS-4		

300...						
300-23			 1882 325 134	380 G380		
			 1878 000 104	380 10 380GTZ		
			 3151 000 395	KZIS-4		
300-25 AHB		F8L513	 3482 124 534	430 GMF430	Getr. / GBox: ZF	
			 1882 301 239 ●	420 GF420	Getr. / GBox: ZF	
			 1878 001 138	420 10 420GTZ	Getr. / GBox: ZF	
			 3151 000 515	KZIS-4	Getr. / GBox: ZF	
300-32 300-34		BF8L513	 3482 124 516	430 GMF430		
			 1878 002 955	420 10 420GTZ		
			 3151 000 515	KZIS-4		
300 PC			 3482 085 033	420 MF420	->Chass. 014757 enthält Druckplattenbefestigungsschrauben / includes bolt for pressure plate mounting	(64)
			 1878 634 020	420 10 420GSZ	->Chass. 014757	
			 3151 117 031	KZI-5	->Chass. 014757	
300 PC Hydro			 1861 572 431	420 10 420/210GS		
300 PT			 3482 085 033	420 MF420	->Chass. 04386 enthält Druckplattenbefestigungsschrauben / includes bolt for pressure plate mounting	(64)
			 1878 634 020	420 10 420GSZ	->Chass. 04386	
			 3151 117 031	KZI-5	->Chass. 04386	

320...						
320-30 N	01.88-	8210	 3482 125 131	420 MF420	Getr. / GBox: Fuller enthält Druckplattenbefestigungsschrauben / includes bolt for pressure plate mounting	(64)
			 1878 002 955	420 10 420GTZ	Getr. / GBox: Fuller	
			 3151 000 515	KZIS-4	Getr. / GBox: Fuller	
320-32 AHB			 3482 124 516	430 GMF430		
			 1878 002 955	420 10 420GTZ		
			 3151 000 515	KZIS-4		











		CODE				
--	--	------	--	---	---	---

IVECO





330...						
330-25 AH, AN 330-26 AH, AN		F8L413F	 3482 124 531	430 GMF430		
			 1882 316 035 ●#	420 GF420		
			 1878 002 955	420 10 420GTZ		
			 3151 000 515	KZIS-4		
330-26 H			 1882 306 242	420 G420N	Nebenantriebs-ID / PTO ID: 110E	(48)
			 1878 003 274	420 10 420GTZ	Nebenantriebs-ID / PTO ID: 110E	(48)
330-26 H, HT 330-26 N 330 PAC 26 330 PC 26 6x4 330 PT 26 6x4		8210	 3400 119 001 ☹	420 10 MF420 420GTZ	enthält Druckplattenbefestigungsschrauben / includes bolt for pressure plate mounting	(64)
			 3482 085 033			
			 1878 001 138			
			 1874 015 200			
 3151 000 515	KZIS-4					
330-30 N	- 12.87		 3400 119 001 ☹	420 10 MF420 420GTZ	enthält Druckplattenbefestigungsschrauben / includes bolt for pressure plate mounting	(64)
			 3482 085 033			
 1878 001 138						
 1874 015 200						
 3151 000 515	KZIS-4					
330-32 AN, ANW		F10L413F	 3482 124 532	430 GMF430		
			 1878 002 955	420 10 420GTZ		
			 3151 000 515	KZIS-4		
330-32 ANW			 1882 306 242	420 G420N	Nebenantriebs-ID / PTO ID: 100E	(48)
			 1878 003 274	420 10 420GTZ	Nebenantriebs-ID / PTO ID: 100E	(48)
330-35 H, HT, HW		8280	 1882 306 242	420 G420N	Getr. / GBox: ZF, Fuller, Fiat Nebenantriebs-ID / PTO ID: 110E	(48)
			 1878 003 274	420 10 420GTZ	Getr. / GBox: ZF, Fuller, Fiat Nebenantriebs-ID / PTO ID: 110E	(48)
330-35 H,HT,HN,HW Prod.-Nr. 42240		8280	 3400 042 031 ☹	420 10 MF420 420GTZ	enthält Druckplattenbefestigungsschrauben / includes bolt for pressure plate mounting	(64)
			 3482 125 131			
			 1878 002 955			
 1874 015 200						
 3151 000 515	KZIS-4					
330-36 AH, AHT	- 05.84		 3483 020 034 ⊕	430 MFZ430		
			 1861 992 432	430 10 430GVZ		
			 3482 083 040	430 MFZ430	In 3483/3488 enthalten / Contained in 3483, 3488	(30)
			 3100 002 040	KZIZ5	Beinhaltet Ausrücker und Montagesatz / Contains releaser and fitting kit	(14)
 3151 000 148						
 3180 001 008						
 3151 000 148						
 3180 001 008						
 3151 000 148						
 3180 001 008						
330-36 AH, AHT	06.84 -		 3483 020 035 ⊕	430 MFZ430		
			 1878 022 841	430 10 430GTZ		
			 3482 083 040	430 MFZ430	In 3483/3488 enthalten / Contained in 3483, 3488	(30)
			 3100 002 038	KZIZ5 KZI/Z-5	Beinhaltet Ausrücker und Montagesatz / Contains releaser and fitting kit	(14)
 3151 123 031						
 3180 001 008						
 3151 123 031						
 3180 001 008						
 3151 123 031						
 3180 001 008						

		CODE				
--	--	------	--	---	---	---













IVECO

330...							
330 PC 26				3400 042 031   3482 125 131  1878 002 955  1874 015 200	420 10 MF420 420GTZ	für / for: Version 42240590 enthält Druckplattenbefestigungsschrauben / includes bolt for pressure plate mounting	(68) (64)
				3482 124 541	430 GMF430	für / for: Version 42240569 für / for: Version 42240611	(68) (68)
				1882 301 239 	420 GF420	für / for: Version 42240569 für / for: Version 42240611	(68) (68)
				1878 001 138	420 10 420GTZ	für / for: Version 42240569 für / for: Version 42240611	(68) (68)
				3151 000 515	KZIS-4		
330 PC 35 330 PT 35		8280		1882 306 242	420 G420N	Getr. / GBox: Fiat, Fuller, ZF Nebenantriebs-ID / PTO ID: 110E	(48)
				1878 003 274	420 10 420GTZ	Getr. / GBox: Fiat, Fuller, ZF Nebenantriebs-ID / PTO ID: 110E	(48)

340...							
340-34		BF8L513		3482 124 516	430 GMF430		
				1878 002 955	420 10 420GTZ		
				3151 000 515	KZIS-4		





















613 - 619							
613 N 3				1878 600 834	250 10 250CB	Chass. 106895->	
616 N 3/4	05.76-			1878 600 834	250 10 250CB		
619 NIP 016045-				3482 085 033	420 MF420	enthält Druckplattenbefestigungsschrauben / includes bolt for pressure plate mounting	(64)
				1878 634 020	420 10 420GSZ		
				3151 117 031	KZI-5		

KAMAZ



Kamaz							
4307		B3.90-140CIV-1 , Cummins		3482 000 419	362 MF362	Getr. / GBox: ZF-S5-42	
				1878 002 599	362 10 362GTZ	Getr. / GBox: ZF-S5-42	
				3151 000 958	KZIS-4	Getr. / GBox: ZF-S5-42	
4308				3483 000 001 	350 MFZ350		
				1878 002 642	350 10 350CZ		
		B5.90-180CIV-0 , Cummins		3482 000 419	362 MF362	Getr. / GBox: ZF-6S-850	
				1878 002 071	362 10 362GTZ	Getr. / GBox: ZF-6S-850	
				3151 000 419	KZIS-4	Getr. / GBox: ZF-6S-850	
5350		740.30-260, KAMAZ/YAMZ		3400 700 345  3482 083 118  1878 000 206  3151 000 034	430 10 MFZ430 430GTZ KZISZ-5	Getr. / GBox: KAMAZ 154	

		CODE				
--	--	------	--	---	---	---

KAMAZ

Kamaz						
5490	12.13-	OM457	 3400 700 420 # ⊗ 3482 000 209 ⊗ 1878 080 037	430 10 MFZ430 430WGTZ	Getr. / GBox: ZF AS Tronic Abgasnorm: Euro 5 / Exhaust Emission Norm: Euro 5	(3)
			 3151 000 493	KZISZ-5	Getr. / GBox: ZF AS Tronic Abgasnorm: Euro 5 / Exhaust Emission Norm: Euro 5 für Ausrückgabel mit Rollen / for release fork with rollers	(3) (70)
			 3482 083 032	430 MFZ430	Getr. / GBox: ZF 16 S 2221 Abgasnorm: Euro 5 / Exhaust Emission Norm: Euro 5	(3)
			 1878 085 641	430 10 430GTZ	Getr. / GBox: ZF 16 S 2221 Abgasnorm: Euro 5 / Exhaust Emission Norm: Euro 5	(3)
			 3151 000 034	KZISZ-5	Getr. / GBox: ZF 16 S 2221 Abgasnorm: Euro 5 / Exhaust Emission Norm: Euro 5	(3)
6460		740.50-360, 740.51-320, KAMAZ/YAMZ	 3400 700 344 ⊗ 3482 083 118 ⊗ 1878 000 205 ⊙ 3151 000 034	430 10 MFZ430 430GTZ KZISZ-5	Getr. / GBox: ZF-Ecosplit 16S-151	
			 3482 083 032	430 MFZ430	Getr. / GBox: ZF 16S-151	
		740.37-400, KAMAZ	 1878 085 641	430 10 430GTZ	Getr. / GBox: ZF 16S-151	
			 3151 000 034	KZISZ-5	Getr. / GBox: ZF 16S-151	
6520		740.50-360, 740.51-320, KAMAZ/YAMZ	 3400 700 344 ⊗ 3482 083 118 ⊗ 1878 000 205 ⊙ 3151 000 034	430 10 MFZ430 430GTZ KZISZ-5	Getr. / GBox: ZF-Ecosplit 16S-151	
		740.51-320, KAMAZ	 3400 700 327 ⊗ 3482 114 031 ⊗ 1878 004 832 ⊙ 3151 263 031	430 10 GMFZ430N 430WGTZ KZIZ-6	für Fahrzeuge mit Nebenantrieb / for vehicles with PTO Nebenantriebs-ID / PTO ID: NMV221	(73) (48)
53215	11.05-	740.11-240, 740.13-260, 740.31-240, KAMAZ/YAMZ	 3482 000 463	395 MF395	Getr. / GBox: KAMAZ Getr. / GBox: 141 142 152	
			 1878 039 631	395 10 395GTZ	Getr. / GBox: KAMAZ Getr. / GBox: 141 142 152	
			 3151 000 958	KZIS-4	Getr. / GBox: KAMAZ Getr. / GBox: 141 142 152	
		740.31-240, KAMAZ/YAMZ	 3400 700 344 ⊗ 3482 083 118 ⊗ 1878 000 205 ⊙ 3151 000 034	430 10 MFZ430 430GTZ KZISZ-5	Getr. / GBox: ZF-Ecosplit 16S-151	
			 3482 083 118	430 MFZ430	Getr. / GBox: ZF-Ecomit 9S-109	
			 1878 000 206	430 10 430GTZ	Getr. / GBox: ZF-Ecomit 9S-109	
			 3151 000 157	KZISZ-5	Getr. / GBox: ZF-Ecomit 9S-109	
65206	12.13-	OM457	 3482 083 032	430 MFZ430	Getr. / GBox: ZF 16 S 2221 Abgasnorm: Euro 5 / Exhaust Emission Norm: Euro 5	(3)
			 1878 085 641	430 10 430GTZ	Getr. / GBox: ZF 16 S 2221 Abgasnorm: Euro 5 / Exhaust Emission Norm: Euro 5	(3)
			 3151 000 034	KZISZ-5	Getr. / GBox: ZF 16 S 2221 Abgasnorm: Euro 5 / Exhaust Emission Norm: Euro 5	(3)

KÄSSBOHRER

Pistenbully						
Pistenbully		OM352A	 1882 252 331	310 GFX310		
			 1861 303 248	310 10 310GSB		
		OM616	 1882 252 331	310 GFX310		























LIEBHERR

Kran / crane						
AK 35 AK 40			 1881 010 139 #	250 G250		
			 1864 202 035 #	250 10		









		CODE				
--	--	------	--	---	---	---

LIEBHERR

Kran / crane

AK 40 b				1880 071 008	225 K225		
				1860 039 025 #	225 10 225Z		
LG 1130 LT 1050 LT 1055 LT 1110				1888 015 523 #	380 GF2/380	enthält eine Kupplungsscheibe / This part number includes one clutch disc	(66)
				1878 000 967 ▽	380 10 380GTZ	Lose Kupplungsscheibe / Loose clutch disc	(39)
				3151 208 001	KZI-5		
				1882 280 213	380 GF2/380	In 1888 enthalten / Contained in 1888	(29)
				1859 212 001	380 GF2/380	In 1888 enthalten / Contained in 1888	(29)
				1878 000 964 △	380 10 380GTZ	In 1888 enthalten / Contained in 1888	(29)
LI 1010				1881 010 139 #	250 G250		
				3151 045 001	KZI-2		
LT 1020 LT 1030 LT 1060		DBOM355		1882 166 737	380 GF380		
LT 1025		KHDBF6L913LL K		1878 001 070	350 10 350GTZ		
				3151 000 395	KZIS-4		
LT 1035		DBOM402		1882 302 131	380 GF380		
				1878 000 105	380 10 380GTZ		
				3151 000 375	KZIS-4		
LT 1045 LT 1080	05.75 -	DBOM403		1888 015 523 #	380 GF2/380	enthält eine Kupplungsscheibe / This part number includes one clutch disc	(66)
				1878 000 967 ▽	380 10 380GTZ	Lose Kupplungsscheibe / Loose clutch disc	(39)
				3151 208 001	KZI-5		
				1882 280 213	380 GF2/380	In 1888 enthalten / Contained in 1888	(29)
				1859 212 001	380 GF2/380	In 1888 enthalten / Contained in 1888	(29)
				1878 000 964 △	380 10 380GTZ	In 1888 enthalten / Contained in 1888	(29)
LTM 1085 OW		D934S		1866 000 062	466 18 466/ 232NGT	max. übertragbares Motormoment [Nm] / max. transmittable engine torque [Nm]: 2719	(87)





Mobilbagger / mobile excavator

A 312 A 314 A 316				1866 156 001	314 18 314/ 159NGS	max. übertragbares Motormoment [Nm] / max. transmittable engine torque [Nm]: 670	(87)
A 350 A 400 A 500 N				1881 010 139 #	250 G250		
				1864 202 035 #	250 10 250Z		
A 353				1880 083 132 #	280 G280		
				1863 100 030	GR-3	mit Anlauftring / with thrust ring	(88)
A 900 C-ZW				1866 157 103	345 24 345/ 232NGT	max. übertragbares Motormoment [Nm] / max. transmittable engine torque [Nm]: 1810	(87)
A 900 LI A 900 ZW				1866 138 101	314 16 314/ 159NGS	max. übertragbares Motormoment [Nm] / max. transmittable engine torque [Nm]: 670	(87)
A 902 Indurstie A 902 LI				1866 136 001	345 16 345/ 159NGS	max. übertragbares Motormoment [Nm] / max. transmittable engine torque [Nm]: 823	(87)



		CODE				
--	--	------	--	---	---	---

LIEBHERR











Mobilbagger / mobile excavator

A 904 A 904 C, HD A 912 A 914, B A 922, HD A 924 B A 924 HD				1866 133 001	345 18 345/ 210NGS	max. übertragbares Motormoment [Nm] / max. transmittable engine torque [Nm]: 1420	(87)
A 932 LI A 934 B LI A 934 LI A 944 LI				1866 135 001	345 24 345/ 210NGS	max. übertragbares Motormoment [Nm] / max. transmittable engine torque [Nm]: 1584	(87)
A 934 C LI				1866 000 151	345 24 345/ 232NGT	max. übertragbares Motormoment [Nm] / max. transmittable engine torque [Nm]: 3415	(87)
A 942		KHD		1866 065 001	345 22 345/210GS	max. übertragbares Motormoment [Nm] / max. transmittable engine torque [Nm]: 1400	(87)

Radlader / wheel loader

L 538 L 542				1866 000 079	466 18 466/ 232NGT	max. übertragbares Motormoment [Nm] / max. transmittable engine torque [Nm]: 2719	(87)
L 544 L 550 L 554 L 556 L 564 L 566 L 574 L 576 L 580				1866 000 007	345 18 345/ 254NGT	max. übertragbares Motormoment [Nm] / max. transmittable engine torque [Nm]: 2490	(87)







Raupenbagger / crawler excavator

MR 500 N R 350 R 400 R 500 N				1881 010 139 #	250 G250		
				1864 202 035 #	250 10 250Z		
R 317				1866 156 001	314 18 314/ 159NGS	max. übertragbares Motormoment [Nm] / max. transmittable engine torque [Nm]: 670	(87)
		BF4M1013C		1866 000 021	314 21 314/ 188NGT	max. übertragbares Motormoment [Nm] / max. transmittable engine torque [Nm]: 1240	(87)
R 321 R 902 LI				1866 136 001	345 16 345/ 159NGS	max. übertragbares Motormoment [Nm] / max. transmittable engine torque [Nm]: 823	(87)
R 324				1866 157 101	345 24 345/ 232NGT	max. übertragbares Motormoment [Nm] / max. transmittable engine torque [Nm]: 2719	(87)
R 353				1880 083 132 #	280 G280		
				1863 100 030	GR-3	mit Anlauftring / with thrust ring	(88)
R 900 LI				1866 138 101	314 16 314/ 159NGS	max. übertragbares Motormoment [Nm] / max. transmittable engine torque [Nm]: 670	(87)
R 912				1866 133 001	345 18 345/ 210NGS	max. übertragbares Motormoment [Nm] / max. transmittable engine torque [Nm]: 1420	(87)
R 932 LI, T R 932 LI TR BAUER R 932 LI TR DELMAG R 934 B, T R 942 LI R 942 LI TR BAUER R 944				1866 135 001	345 24 345/ 210NGS	max. übertragbares Motormoment [Nm] / max. transmittable engine torque [Nm]: 1584	(87)

		CODE				
--	--	------	--	---	---	---







LIEBHERR

Raupenbagger / crawler excavator



R 934 C				1866 135 001	345 24 345/ 210NGS	max. übertragbares Motormoment [Nm] / max. transmittable engine torque [Nm]: 1584	(87)
				1866 000 151	345 24 345/ 232NGT	max. übertragbares Motormoment [Nm] / max. transmittable engine torque [Nm]: 3415	(87)
R 942				1866 065 001	345 22 345/210GS	max. übertragbares Motormoment [Nm] / max. transmittable engine torque [Nm]: 1400	(87)
R 944 C TU				1866 000 151	345 24 345/ 232NGT	max. übertragbares Motormoment [Nm] / max. transmittable engine torque [Nm]: 3415	(87)
R 952, LI R 962-133 LC R 962-225 HD R 962-226 LC SL R 962-385 HD-EW				1866 090 001	390 18 390/ 210NGS	max. übertragbares Motormoment [Nm] / max. transmittable engine torque [Nm]: 1950	(87)
R 964 B R 964 LI R 974				1866 148 001	466 22 466/ 288NGT	max. übertragbares Motormoment [Nm] / max. transmittable engine torque [Nm]: 2789	(87)
R 974 C R 984 C				1866 000 152	466 22 466/ 288NGT	max. übertragbares Motormoment [Nm] / max. transmittable engine torque [Nm]: 4500	(87)

MAGIRUS-DEUTZ



A 3500 - S 5500

A 3500 A 4500 (Mercur) S 3500 S 4500		F4L514		1880 083 132 #	280 G280		
				1863 100 030	GR-3	mit Anlauftring / with thrust ring	(88)
S 4500 , F3, M6, TW6 (Chassis K 3500) S 4500 F				1880 083 132 #	280 G280		
				1863 100 030	GR-3	mit Anlauftring / with thrust ring	(88)
S 4500 S S 5500				1881 039 532 #	350 G350KR		
				1878 001 074	350 10 350GTZ		
				1863 100 030	GR-3	mit Anlauftring / with thrust ring	(88)

Jupiter

Jupiter 6x6 Z				1882 325 134	380 G380		
				1861 470 234	380 10 380GSZ		
				1863 010 100	GR-4	mit Anlauftring / with thrust ring	(88)

Mercur



Mercur A Mercur S		F4L514		1880 083 132 #	280 G280		
				1863 100 030	GR-3	mit Anlauftring / with thrust ring	(88)

Saturn

Saturn		S6L714		1881 039 532 #	350 G350KR		
				1878 001 074	350 10 350GTZ		
Saturn -Europawagen		S6L714		1882 325 139	380 G380		
				1878 000 104	380 10 380GTZ		
				3151 000 395	KZIS-4		



		CODE				
--	--	------	--	---	---	---



MAGIRUS-DEUTZ



Saturn						
Saturn 145 a		F6L714		1881 039 532 #	350 G350KR	
				1878 001 074	350 10 350GTZ	
				1863 100 030	GR-3	mit Anlaufring / with thrust ring

70...						
70 D 6 FL		F4L812D		1881 010 139 #	250 G250	
				3151 045 001	KZI-2	
70 M 6 FL				3151 199 001	KZIS-3	
75 D 6 FL		F4L912		1881 010 139 #	250 G250	
				3151 045 001	KZI-2	

80...						
80 D 6/7/8 FK				1881 010 139 #	250 G250	Getr. / GBox: 5-524
				3151 045 001	KZI-2	Getr. / GBox: 5-524







90...						
90 D 5,2 FL,FV,FK		F4L913		3151 199 001	KZIS-3	
90 D 5,6 FL,FV,FK						
90 D 6,0 FL,FV,FK						
90 D 6,5 FL,FV,FK						
90 D 7,5 FL,FV,FK						
90 M 6 FL,FK						
90 M 7 FL,FG,FG,FK						
90 M 8 FL,FK						
90 M 9 FL						
90 M 5,3 FL,FV,FK	-02.82	F4L913		1878 600 841	280 10 280CTB	
90 M 5,7 FL,FV,FK	-02.82					
90 M 5,9 FL,FV,FK	-02.82			1850 282 652	KZA-2	
90 M 6,0 FL,FK,FV	-02.82					
90 M 6,6 FL,FV,FK	-02.82					
90 M 7,5 FL,FV,FK	-02.82					
90 M 7,9 FL, FV, FK	-02.82					
90 M 9,0	-02.82					

















100...							
100 R		F6L413		1881 039 532 #	350 G350KR	Getr. / GBox: ZF S-6/80	
				1878 005 367	350 10 350WGTZ	Getr. / GBox: ZF S-6/80	
				1863 100 030	GR-3	Getr. / GBox: ZF S-6/80 mit Anlaufring / with thrust ring	(88)



110...						
110 D 7,8,9,11				1881 096 444 ▲	280 HV280	
				1862 039 015 #	280 10 280BZ	
112 D 9 AS				1881 039 532 #	350 G350KR	
				1878 001 074	350 10 350GTZ	
				1863 100 030	GR-3	mit Anlaufring / with thrust ring

		CODE			 Parameter		
--	--	------	--	--	---	---	---

MAGIRUS-DEUTZ



120...							
120				1861 600 033 #	310 10 310GTD		
120 F				1863 100 030	GR-3	mit Anlauftring / with thrust ring	(88)
125 D 10 A							
126							
126 AK							
126 D 11							
126 F							
120 D 7/9/11		F6L912		1881 096 444 ▲	280 HV280		
120 D 12				1863 100 030	GR-3	mit Anlauftring / with thrust ring	(88)
120 D 13							
126 D 12, 14 F		F6L312		1861 600 033 #	310 10 310GTD		
				1863 100 030	GR-3	mit Anlauftring / with thrust ring	(88)















130...							
130 D 7 FA				1861 479 032 #	295 10 295GSZ		
130 D 9 AL	-06.77			3151 199 001	KZIS-3		
130 D 9 AS,L							
130 D 13 AK	-03.77						
130 D 13 K,L							
130 D 14 FL							
130 D 15 AK, K							
130 D 17 FA							
130 D 9 AL	07.77 -			3482 002 234	350 GMF350X		
				1878 001 070	350 10 350GTZ		
				3151 000 515	KZIS-4		
130 D 9 FA				1861 479 032 #	295 10 295GSZ	für / for: Version 2550361	(68)
				3151 199 001	KZIS-3	für / for: Version 2550361	(68)
130 D 9 FA, FL		F6L913/Turbo		3482 008 033	310 MF310		
130 D 11 FL				1861 577 037 #	310 10 310GTD		
130 D 12 AK, K				3151 199 001	KZIS-3		
130 D 13 FL							
130 D 15 K							
130 D 16 FL, FLL							
130 M 7 FL, FAL							
130 M 8 FL, FS, FK, FAL							
130 M 9 FL, FS, FK, FG							
130 M 11 FL, FK							
130 M 13 FL							
130 M 13 FL,FGB,FK							
130 D 11 F,H,K		F6L913		1861 479 032 #	295 10 295GSZ		
130 D 12 F,H,K				3151 199 001	KZIS-3		
130 D 15 F,H,K							
130 D 13 AK	04.77 -			3482 002 234	350 GMF350X		
				1878 001 070	350 10 350GTZ		
				3151 000 395	KZIS-4		
135 D 10, D 12, D 14 FS, FL		F6L312		1861 600 033 #	310 10 310GTD		
				1863 100 030	GR-3	mit Anlauftring / with thrust ring	(88)

















140...							
140 D 11 F, K, AK				1881 039 532 #	350 G350KR		
				1878 001 074	350 10 350GTZ		

		CODE				
--	--	------	--	---	---	---

MAGIRUS-DEUTZ









140...						
145 AK 6x6		D8FL		1881 039 532 #	350 G350KR	
				1878 001 074	350 10 350GTZ	
				1863 100 030	GR-3	mit Anlauftring / with thrust ring

















150...						
150 ,150/1F 150 AK 6x6 150 D 13 FL, FS 150 D 14 156 D 15 K	-02.62			1881 039 532 #	350 G350KR	
				1878 001 074	350 10 350GTZ	
				1863 100 030	GR-3	mit Anlauftring / with thrust ring
150 AK 6x6 150 L 6x4 156 D 22	03.62 -			1881 039 532 #	350 G350KR	
				1878 001 074	350 10 350GTZ	
150 D 10 A		F6L714		1878 001 074	350 10 350GTZ	
				1863 100 030	GR-3	mit Anlauftring / with thrust ring
150 D 14 AK				1861 600 033 #	310 10 310GTD	
				1863 100 030	GR-3	mit Anlauftring / with thrust ring
150 D 22 FL 6x4		F6L714		1881 039 532 #	350 G350KR	
				1878 001 074	350 10 350GTZ	
				1863 100 030	GR-3	mit Anlauftring / with thrust ring
156 D 14 K 156 D 15 AK 156 D 16 AK		FL814		1881 039 532 #	350 G350KR	
				1878 001 074	350 10 350GTZ	
				1863 100 030	GR-3	mit Anlauftring / with thrust ring





160...						
160 D 11 FL, FS 160 D 12 K 160 D 15 K 160 D 16 FL, FLL 160 M 11 FL, FS		BF6L913		3482 060 233	350 MF350	
				1861 777 037	350 10 350GTD	
				3151 199 001	KZIS-3	
160 D 11-D 17				1882 307 131	350 GF350	
				1878 001 074	350 10 350GTZ	
				3151 000 515	KZIS-4	
160 D 12 AK 168 M 13 FL 168 M 16 FL	01.82 -			1882 307 131	350 GF350	
				1878 001 070	350 10 350GTZ	
				3151 000 515	KZIS-4	
160 D 12 AK	-12.81			1861 479 032 #	295 10 295GSZ	
				3151 199 001	KZIS-3	
160 D 16 FL				1882 307 131	350 GF350	
				1878 001 074	350 10 350GTZ	
160 M 11 FA, FS, FK 160 M 13 FL, FS, FK 160 M 7 FA 160 M 8 FL, FAL 168 M 11 FL, FAL				3482 038 031	350 GMF350	
				1861 742 032	350 10 350GTB	
				3151 199 001	KZIS-3	

		CODE				
--	--	------	--	---	---	---

MAGIRUS-DEUTZ



160...						
160 M 11 FK (Version 2550435)				3482 008 036 #	310 MF310	
				1861 577 136 #	310 10 310GTD	
				3151 199 001	KZIS-3	
168 M 14 FK 168 M 14 FL (Version 42230423)				3482 002 234	350 GMF350X	
				1878 001 077	350 10 350GTZ	
				3151 000 515	KZIS-4	
168 M 14 FL				1882 307 131	350 GF350	für / for: Version 61602271 (68)
				1878 001 070	350 10 350GTZ	für / for: Version 61602271 (68)
				3151 000 515	KZIS-4	für / for: Version 61602271 (68)























170...						
170 D 10 AK 170 D 11 F 170 D 11 FA 170 D 21 AK 6x6		- 11.83		1881 039 532 #	350 G350KR	
				1878 001 074	350 10 350GTZ	
				1863 100 030	GR-3	mit Anlauftring / with thrust ring (88)
170 D 11 FA		12.83-		3482 002 234	350 GMF350X	
				1878 001 070	350 10 350GTZ	
				3151 000 515	KZIS-4	
170 D 11 FL 170 D 12 AK, AL 170 D 12, FL 170 D 13 FS, FL 170 D 15 AK, FAK, FK, K 170 D 15 FL 170 D 16 FL 170 D 16 K 170 D 17 F, K, AK 170 D 19 L, FL, AL 170 D 24 K, L		F6L413		1881 039 532 #	350 G350KR	
				1878 005 367	350 10 350WGTZ	
				1863 100 030	GR-3	mit Anlauftring / with thrust ring (88)
170 D 11 FL				1882 261 013 #	380 G380N	Nebenantriebs-ID / PTO ID: 70/1 (48)
				3151 111 032	KZI-6	ohne Schmierrohranschluß / without lubricating pipe connection (103) Nebenantriebs-ID / PTO ID: 70/1 (48)
170 D 14 SL, FL, FS		F6L413		1881 039 532 #	350 G350KR	
				1878 005 367	350 10 350WGTZ	
				1863 100 030	GR-3	mit Anlauftring / with thrust ring (88)
170 D 19 F				1882 325 134	380 G380	
				1861 351 342 #	380 10 380WGSZ	
				1863 100 030	GR-3	mit Anlauftring / with thrust ring (88)









180...						
180 D 12 FL				1878 001 074	350 10 350GTZ	
				1863 100 030	GR-3	mit Anlauftring / with thrust ring (88)
180 LS 12		F8L312		1881 039 532 #	350 G350KR	
				1878 001 074	350 10 350GTZ	

		CODE		 Parameter		
--	--	------	--	---	---	---

MAGIRUS-DEUTZ





180...						
186 D 13 FL		FL312		1878 001 074	350 10 350GTZ	
186 D 15 FL				1863 100 030	GR-3	mit Anlaufring / with thrust ring (88)
186 D 17 FL						



190...						
190 D 9 AL				1861 479 032 #	295 10 295GSZ	
				3151 199 001	KZIS-3	
192 D 11 F, FA				3482 002 234	350 GMF350X	
192 D 13 F				1878 001 070	350 10 350GTZ	
192 M 12 FA				3151 000 515	KZIS-4	
192 D 12 AL				3482 002 234	350 GMF350X	
				1878 001 070	350 10 350GTZ	
				3151 000 395	KZIS-4	
192 M 14 FL 2				1882 325 134	380 G380	
				1878 000 957	380 10 380GTZ	
				3151 000 515	KZIS-4	
192 M 14 FL, FS				1882 325 134	380 G380	
192 M 16 F, FL, FS				1878 000 957	380 10 380GTZ	
195				1882 325 134	380 G380	Radstand [mm] / Wheelbase [mm]: 5400 Für Export / for export (53) (25)
195 L				1861 470 234	380 10 380GSZ	Radstand [mm] / Wheelbase [mm]: 5400 Für Export / for export (53) (25)
				1863 010 100	GR-4	Radstand [mm] / Wheelbase [mm]: 5400 Für Export / for export (53) (25) mit Anlaufring / with thrust ring (88)
195				1882 325 134	380 G380	
				1861 470 234	380 10 380GSZ	
				1863 010 100	GR-4	mit Anlaufring / with thrust ring (88)
195 D		F8L714		1882 325 134	380 G380	
				1861 351 342 #	380 10 380WGSZ	
				1863 010 100	GR-4	mit Anlaufring / with thrust ring (88)



















200...						
200 D 15 FAK				1882 325 134	380 G380	
200 D 18				1878 000 104	380 10 380GTZ	
200 D 16				1882 325 134	380 G380	
200 D 26				1861 470 234	380 10 380GSZ	
200 D F, K, AK, S, L				1863 010 100	GR-4	mit Anlaufring / with thrust ring (88)
200 D FS, FL 6x4						
200 D 16 F				1882 325 134	380 G380	
200 D 22 B				1878 000 104	380 10 380GTZ	
				3151 000 395	KZIS-4	

		CODE				
--	--	------	--	---	---	---

MAGIRUS-DEUTZ





210...						
210 D 16				1882 325 134	380	
210 D 16 F					G380	
210 D 18				1878 000 104	380 10	
					380GTZ	
210 D 16 AK				1882 325 134	380	
210 D 22					G380	
210 D 26 K				1878 000 104	380 10	
					380GTZ	
				3151 000 395	KZIS-4	





























220...						
228 M 16 AK				1882 325 139	380	
					G380	
				1878 000 957	380 10	
					380GTZ	
				3151 000 515	KZIS-4	

230...						
230 D 16 F				1882 325 134	380	
232 D 20 AL (Version 2551578)					G380	
232 D 26 B				1878 000 104	380 10	
232 D 30 AK, FAK					380GTZ	
232 D 30 FK				3151 000 395	KZIS-4	
232 D 32 A						
232 D 32 K						
230 D 16 FAK				1882 325 134	380	
					G380	
				1878 000 104	380 10	
					380GTZ	
230 D 18 AK		FL914		1882 325 134	380	
230 D 19 FL					G380	
230 D 22 K				1878 000 104	380 10	
230 D 26 AK					380GTZ	
230 D 22 FT 6x6		F8L914		1882 325 134	380	
					G380	
				1878 000 104	380 10	
					380GTZ	
				3151 000 395	KZIS-4	
232 D 15 FK, FAK, FS, FL		F8L413		1882 325 134	380	
232 D 16 F, AK, FS, FL					G380	
232 D 17 F, FA				1878 000 104	380 10	
232 D 19 AK, K, FAK, FK, FL, FS, L, S					380GTZ	
232 D 19 K, L				3151 000 395	KZIS-4	
232 D 22 AK, FAK, FK 6x6, FB 6x4						
232 D 24 L, K, FK						
232 D 26 AK, F, FAK, FB, FK, K, L, S						
232 D 26 K 6x4						
232 D 16 AL				1882 325 139	380	
232 D 20 AL					G380	
				1878 000 957	380 10	
					380GTZ	
				3151 000 515	KZIS-4	
232 D 17				3482 124 541	430	
					GMF430	
				1882 330 032 ●#	420	
					GF420	
				1878 634 017	420 10	
					420GSZ	
				3151 000 515	KZIS-4	

		CODE				
--	--	------	--	---	---	---























MAGIRUS-DEUTZ

230...						
232 D 17 FA (Version 42230187)				3482 002 234	350 GMF350X	
				1878 001 070	350 10 350GTZ	
				3151 000 515	KZIS-4	
235 D 22 FL, FS 6x4				1882 325 139	380 G380	
				1878 000 104	380 10 380GTZ	
				3151 000 395	KZIS-4	

250...						
250 D 22 250 D 22 FK 6x4 (10 Zyl.)				1882 325 139	380 G380	
				1878 000 104	380 10 380GTZ	
				3151 000 395	KZIS-4	
250 D 22 FK 6x4				1882 325 134	380 G380	
				1878 000 104	380 10 380GTZ	
				3151 000 395	KZIS-4	
256 D 14 F 256 D 16 AK (Version 2551676) 256 D 16 FS, FL, FLL, K 256 D 19 AK, FL,FS, K, S 256 D 22 FLL 256 D 26 AK, K, 6x4 256 D 26 FB 6x4		F8L413		1882 325 139	380 G380	
				1878 000 957	380 10 380GTZ	
				3151 000 515	KZIS-4	
256 D 16 FB 6x4 (Version 42231436)				1882 325 134	380 G380	
				1878 000 957	380 10 380GTZ	
				3151 000 395	KZIS-4	
256 D 16 SS				1882 306 136 #	420 G420N	Getr. / GBox: S 6-90-GV 90 für Nebenantrieb / for PTO (82)
256 M 19 256 M 22		F8L413F		3482 124 532	430 GMF430	Getr. / GBox: ZF S 6-90 Getr. / GBox: Fiat E 100
				1878 001 138	420 10 420GTZ	Getr. / GBox: ZF S 6-90 Getr. / GBox: Fiat E 100
				3151 071 032	KZI-4,5	Getr. / GBox: Fiat E 100
				3151 098 031	KZI-4,5	Getr. / GBox: ZF S 6-90
256 M 19 A, AT		F8L413F		3482 124 532	430 GMF430	Getr. / GBox: Fuller
				1878 001 138	420 10 420GTZ	Getr. / GBox: Fuller
				3151 127 031	KZI-4,5	Getr. / GBox: Fuller
256 M 19 AK	12.84-	F8L413F		3482 124 531	430 GMF430	
				1882 316 035 ●#	420 GF420	
				1878 002 955	420 10 420GTZ	
				3151 000 515	KZIS-4	
256 M 19 AK, AS, K, L, S 256 M 19 FAK, FK, FKL, FKS	- 11.84 - 11.84	F8L413F		3482 124 531	430 GMF430	Getr. / GBox: ZF
				1882 316 035 ●#	420 GF420	Getr. / GBox: ZF
				1878 001 138	420 10 420GTZ	Getr. / GBox: ZF
				3151 000 515	KZIS-4	Getr. / GBox: ZF

		CODE				
--	--	------	--	---	---	---

MAGIRUS-DEUTZ

















250...						
256 M 19 F, FL, FS, FSL 256 M 22 F, FL, FS, FSL	F8L413		3482 124 531	430 GMF430	Getr. / GBox: ZF	
			1882 316 035 ●#	420 GF420	Getr. / GBox: ZF	
			1878 001 138	420 10 420GTZ	Getr. / GBox: ZF	
			3151 098 031	KZI-4,5	Getr. / GBox: ZF	
256 M 19 FL, FS, FSL 256 M 22 FL, FS, FSL	F8L413F		3482 124 531	430 GMF430	Getr. / GBox: Fuller	
			1882 316 035 ●#	420 GF420	Getr. / GBox: Fuller	
			1878 001 138	420 10 420GTZ	Getr. / GBox: Fuller Getr. / GBox: Fiat E 90	
			3151 071 032	KZI-4,5	Getr. / GBox: Fiat E 90	
256 M 19 FLL			3482 124 532	430 GMF430		
			1878 001 138	420 10 420GTZ		
			3151 127 031	KZI-4,5		
256 M 19 K			1882 306 136 #	420 G420N	Nebenantriebs-ID / PTO ID: 110E	(48)
256 M 26 AK 6x6, K, S 6x4 256 M 26 AK Prod.-Nr. 77311 256 M 26 FAK, FK, FKL, FKS 256 M 26 K, L, S Prod.-Nr. 77211	F8L413F		3482 124 531	430 GMF430	Getr. / GBox: ZF	
			1882 316 035 ●#	420 GF420	Getr. / GBox: ZF	
			1878 002 955	420 10 420GTZ	Getr. / GBox: ZF	
			3151 000 515	KZIS-4	Getr. / GBox: ZF	
256 M 26 FB, L 6x4	F8L413F		1882 325 139	380 G380	Getr. / GBox: ZF	
			1878 000 957	380 10 380GTZ	Getr. / GBox: ZF	
			3151 000 515	KZIS-4	Getr. / GBox: ZF	
256 M 26 K (Version 42230027)			3482 002 234	350 GMF350X		
			1878 001 070	350 10 350GTZ		
			3151 000 515	KZIS-4		
256 M 33 K, FK			3482 124 531	430 GMF430		
			1882 316 035 ●#	420 GF420		
			1878 002 955	420 10 420GTZ		
			3151 000 515	KZIS-4		







260...						
260 D FAL 6x6	F10L413		3482 124 541	430 GMF430		
			1882 330 032 ●#	420 GF420		
			1878 634 017	420 10 420GSZ		
			3151 000 515	KZIS-4		

270...						
270 D 16 FAK, FK 270 D 19 270 D 22 FL, FLL, FS 270 D 26 AK, FAK			3482 124 534	430 GMF430		
			1882 301 239 ●	420 GF420		
			1878 634 017	420 10 420GSZ		
			3151 000 515	KZIS-4		

MAGIRUS-DEUTZ























280...						
280 M 26 FS			 3482 124 534	430 GMF430		
			 1882 301 239 ●	420 GF420		
			 1878 002 706	420 10 420GTZ		
			 3151 000 515	KZIS-4		







290...						
290 D 19 K 290 D 19 L 290 D 22 290 D 26 K 290 D 26 L			 3482 124 541	430 GMF430		
			 1882 330 032 ●#	420 GF420		
			 1878 634 017	420 10 420GSZ		
			 3151 000 515	KZIS-4		
290 D 19 Turbo		F8L413	 3482 124 533 #	420 GMF430	Getr. / GBox: Fuller	
			 1878 002 955	420 10 420GTZ	Getr. / GBox: Fuller	
			 3151 127 031	KZI-4,5	Getr. / GBox: Fuller	
290 D 22 FK 6x4 (10 Zyl./cyl.)			 1882 325 139	380 G380		
			 1878 000 104	380 10 380GTZ		
			 3151 000 395	KZIS-4		
290 D 26 FAL 6x6		F10L413	 3482 124 541	430 GMF430		
			 1882 330 032 ●#	420 GF420		
			 1878 634 017	420 10 420GSZ		
			 3151 000 515	KZIS-4		
290 M 19 FL, FS 290 M 22 AP, FL, FLL		BF8L413F	 3482 124 533 #	420 GMF430		
			 1878 002 955	420 10 420GTZ		
			 3151 127 031	KZI-4,5		

310...						
310 D 15 AK, FAK, FK, FL, FS, K 310 D 16 AK, FAK, FK, FLL, FS, K, S 310 D 16 FL 310 D 16 FSL (Version 42230102) 310 D 19 AK, FAK, FK, FL, FS, S 310 D 21 F 310 D 22 AK, FAK, FAL, FK, FL, FS 310 D 22 FA (Version 42230120) 310 D 26 AK, FAK, FK, FS, S 310 D 28 FK, FL 310 D 32 K	- 10.76		 3482 124 534	430 GMF430		
			 1882 301 239 ●	420 GF420		
			 1878 634 017	420 10 420GSZ		
			 3151 000 515	KZIS-4		
310 D 16 FL	11.76-		 3482 124 522	430 GMF430		
			 1878 634 017	420 10 420GSZ		
			 3151 000 515	KZIS-4		

		CODE		 Parameter		
--	--	------	--	---	---	---



































MAGIRUS-DEUTZ

310...							
310 D 16 FSL (Version 2550517)				1881 039 532 #	350 G350KR		
				1878 005 367	350 10 350WGTZ		
				1863 100 030	GR-3	mit Anlauftring / with thrust ring	(88)
310 D 22 FA (Version 42230008) 310 D 26 FAK (Version 42241400) 310 D 26 FK 6x4				1882 306 242	420 G420N	für Nebenantrieb / for PTO	(82)
				1878 003 274	420 10 420GTZ	für Nebenantrieb / for PTO	(82)
310 D 26 AK (Version 2551686) 310 D 26 K (Version 42231407)				3482 124 534	430 GMF430		
				1882 330 032 ●#	420 GF420		
				1878 634 017	420 10 420GSZ		
				3151 000 515	KZIS-4		
310 D 26 K (Version 2551652)				3482 124 541	430 GMF430		
				1882 301 239 ●	420 GF420		
				1878 634 017	420 10 420GSZ		
				3151 000 515	KZIS-4		
310 D 232				1882 325 134	380 G380		
				1878 000 104	380 10 380GTZ		
				3151 000 395	KZIS-4		
310 D 32 AK 310 D 32 K 310 D 32 L	- 01.78 07.76 - 01.78			1882 320 131	420 GF420	Nur bei Altteil-Rückgabe lieferbar (Reparatur; Werk Bielefeld) / Please return old unit for repair (plant Bielefeld)	(49)
				1878 001 138	420 10 420GTZ		
				3151 000 515	KZIS-4		
310 D 32 AK 6x6 HD	02.78 -	F10L413L		3482 124 532	430 GMF430		
				1878 002 955	420 10 420GTZ		
				3151 000 515	KZIS-4		
310 D 32 K 310 D 32 L	02.78 - 02.78 -			3482 124 532	430 GMF430		
				1878 001 138	420 10 420GTZ		
				3151 000 515	KZIS-4		

320...							
320 D 19 FAK 320 M 33 AK, K, L				3482 124 532	430 GMF430		
				1878 002 955	420 10 420GTZ		
				3151 000 515	KZIS-4		
320 D 20 AL, AS, FAT, FS				3482 124 534	430 GMF430		
				1882 301 239 ●	420 GF420		
				1878 634 017	420 10 420GSZ		
				3151 000 515	KZIS-4		

		CODE		 Parameter		
--	--	------	--	---	---	---

MAGIRUS-DEUTZ



320...						
320 D 21 HL 320 D 26 AK			 3482 124 541	430 GMF430		
			 1882 330 032 ●#	420 GF420		
			 1878 634 017	420 10 420GSZ		
			 3151 000 515	KZIS-4		
320 D 26 AL	11.83-		 3482 124 533 #	420 GMF430		
			 1878 003 657	420 10 420WGTZ		
			 3151 000 515	KZIS-4		
320 D 26 AL	- 10.83		 3482 124 532	430 GMF430		
			 1878 003 657	420 10 420WGTZ		
			 3151 000 515	KZIS-4		
320 D 26 F, FA, FT		F10L413F	 3482 124 541	430 GMF430		
			 1882 301 239 ●	420 GF420		
			 1878 634 017	420 10 420GSZ		
			 3151 000 515	KZIS-4		
320 D 34 AS			 3482 124 532	430 GMF430		
			 1878 001 138	420 10 420GTZ		
			 3151 000 515	KZIS-4		
320 M 19 320 M 22		F10L413F	 3482 124 533 #	420 GMF430	Getr. / GBox: ZF Getr. / GBox: Fuller	
			 1878 002 955	420 10 420GTZ	Getr. / GBox: ZF Getr. / GBox: Fuller	
			 3151 127 031	KZI-4,5	Getr. / GBox: Fuller	
			 3151 000 515	KZIS-4	Getr. / GBox: ZF	
320 M 19 A, AT		BF8L413F	 3482 124 532	430 GMF430	Getr. / GBox: Fuller	
			 1878 002 955	420 10 420GTZ	Getr. / GBox: Fuller	
			 3151 000 515	KZIS-4	Getr. / GBox: Fuller	
320 M 19 FAK, FK, FKL, FKS		BF8L413F	 3482 124 533 #	420 GMF430		
			 1878 002 955	420 10 420GTZ		
			 3151 000 515	KZIS-4		
	F10L413F	 3482 124 532	430 GMF430	Getr. / GBox: ZF		
		 1878 002 955	420 10 420GTZ	Getr. / GBox: ZF		
		 3151 000 515	KZIS-4	Getr. / GBox: ZF		
320 M 19 FL, FS, FSL 320 M 22 FL, FS, FSL		F10L413F	 3482 124 532	430 GMF430	Getr. / GBox: Fuller	
			 1878 002 955	420 10 420GTZ	Getr. / GBox: Fuller	
			 3151 127 031	KZI-4,5	Getr. / GBox: Fuller	
320 M 26 FAK		F10L413F	 1882 306 242	420 G420N	Nebenantriebs-ID / PTO ID: 110E	(48)
			 1878 003 274	420 10 420GTZ	Nebenantriebs-ID / PTO ID: 110E	(48)















		CODE					
--	--	------	--	--	---	---	---

MAGIRUS-DEUTZ

320...							
320 M 26 FAK 6x6 320 M 26 FK, FKL, FKS (6x4),		F10L413F		3482 124 532	430 GMF430	Getr. / GBox: ZF	
				1878 002 955	420 10 420GTZ	Getr. / GBox: ZF	
				3151 000 515	KZIS-4	Getr. / GBox: ZF	
320 M 26 FK, FKL		BF8L413F		3482 124 533 #	420 GMF430	Getr. / GBox: Fuller	
				1878 002 955	420 10 420GTZ	Getr. / GBox: Fuller	
				3151 000 515	KZIS-4	Getr. / GBox: Fuller	

340...							
340 D 16 FS, FL 6x4 340 D 22 FS, FL 6x4	05.72 -			3482 124 522	430 GMF430		
				1878 634 017	420 10 420GSZ		
				3151 000 515	KZIS-4		

350...							
350 F 33, PC, PT		8280		3400 042 031 ☹ ⊗ 3482 125 131 ⊗ 1878 002 955 ⊗ 1874 015 200	420 10 MF420 420GTZ	Getr. / GBox: Fiat enthält Druckplattenbefestigungsschrauben / includes bolt for pressure plate mounting	(64)
				3151 000 515	KZIS-4	Getr. / GBox: Fiat	











360...							
360 D 18 FL, FS				3482 124 533 #	420 GMF430		
				1878 001 138	420 10 420GTZ		
				3151 000 515	KZIS-4		
360 M 19 A, AT 360 M 22 AP, APT		BF10L413F		3483 020 034 ⊕	430 MFZ430		
				1861 992 432	430 10 430GVZ		
				3482 083 040	430 MFZ430	In 3483/3488 enthalten / Contained in 3483, 3488	(30)
				3100 002 040 ⊗ 3151 000 148 ⊗ 3180 001 008	KZIZ5	Beinhaltet Ausrücker und Montagesatz / Contains releaser and fitting kit In 3483/3488 enthalten / Contained in 3483, 3488	(14) (30)
360 M 19 APT		BF10L413F		3482 124 533 #	420 GMF430		
				1878 002 955	420 10 420GTZ		
				3151 127 031	KZI-4,5		
360 M 33 F, FKS				3483 020 035 ⊕	430 MFZ430		
				1878 022 841	430 10 430GTZ		
				3482 083 040	430 MFZ430	In 3483/3488 enthalten / Contained in 3483, 3488	(30)
				3100 002 038 ⊗ 3151 123 031 ⊗ 3180 001 008	KZIZ5 KZI/Z-5	Beinhaltet Ausrücker und Montagesatz / Contains releaser and fitting kit In 3483/3488 enthalten / Contained in 3483, 3488	(14) (30)

MAN

F 90							
06.86 - 12.97							
16.242 F01,02,03 32.242 F09,10	01.85 -	D2866F		3400 700 310 ⊗ 3482 078 133 ⊗ 1862 364 133 ⊗ 3151 000 034	400 10 MFZ400 400WGVZ KZISZ-5	Nabenprofil / Hub Profile: 1 3/4"-10N	(46)
	01.87 - 12.92						















		CODE				
--	--	------	--	---	---	---

MAN

F 90		06.86 - 12.97					
16.262 F01,02,03 30.262 F13,14 31.262 F13,14 36.262 F14 36.272 F14	01.85 - 12.92 01.89 - 01.89 - 01.88 - 12.93 01.88 - 12.93	D2865LF	 3400 700 310 ⊗ 3482 078 133 ⊗ 1862 364 133 ⊙ 3151 000 034	400 10 MFZ400 400WGVZ KZISZ-5	Nabenprofil / Hub Profile: 1 3/4"-10N	(46)	
16.272 F01,02,03	01.90 -	D2865LF01/02/04/05	 3400 700 310 ⊗ 3482 078 133 ⊗ 1862 364 133 ⊙ 3151 000 034	400 10 MFZ400 400WGVZ KZISZ-5	Nabenprofil / Hub Profile: 1 3/4"-10N	(46)	
16.292 F01,02,03 28.292 F09,13,14 30.292 F13,14 31.292 F13,14 32.292 F09,10,13,14 36.292 F14 36.332 F14 38.292 F17	01.85 - 12.92 01.86 - 01.87 - 01.87 - 01.85 - 01.88 - 12.93 01.88 - 12.93 01.85 -	D2866LF07	 3400 127 601 ⊗ 3482 078 133 ⊗ 1862 364 031 ⊙ 3151 000 034	400 10 MFZ400 400WGVZ KZISZ-5	Nabenprofil / Hub Profile: 2"-10N Je nach Kundenwunsch mit unterschiedlicher Kupplung / Equipped with different clutch according to customer requirement	(46) (33)	
			 3400 122 201 ⊗ 3482 083 032 ⊗ 1878 004 832 ⊙ 3151 000 034	430 10 MFZ430 430WGTZ KZISZ-5	Je nach Kundenwunsch mit unterschiedlicher Kupplung / Equipped with different clutch according to customer requirement	(33)	
16.302 F01,02,03 28.302 F09,13,14 30.302 F13,14 31.302 F13,14	01.90 - 12.92 01.90 - 01.90 - 01.90 -	D2866LF04	 3400 127 601 ⊗ 3482 078 133 ⊗ 1862 364 031 ⊙ 3151 000 034	400 10 MFZ400 400WGVZ KZISZ-5	Nabenprofil / Hub Profile: 2"-10N	(46)	
16.322 F01,02,03,U11	01.90 -	D2865LF03/06	 3400 127 601 ⊗ 3482 078 133 ⊗ 1862 364 031 ⊙ 3151 000 034	400 10 MFZ400 400WGVZ KZISZ-5	Nabenprofil / Hub Profile: 2"-10N	(46)	
16.332 F01,02,03 28.332 F09,13,14 30.332 F13,14 31.332 F13,14 38.332 F17	01.85 - 12.92 01.86 - 01.87 - 01.87 - 01.85 -	D2866LF08	 3400 127 601 ⊗ 3482 078 133 ⊗ 1862 364 031 ⊙ 3151 000 034	400 10 MFZ400 400WGVZ KZISZ-5	Nabenprofil / Hub Profile: 2"-10N Je nach Kundenwunsch mit unterschiedlicher Kupplung / Equipped with different clutch according to customer requirement	(46) (33)	
			 3400 122 201 ⊗ 3482 083 032 ⊗ 1878 004 832 ⊙ 3151 000 034	430 10 MFZ430 430WGTZ KZISZ-5	Je nach Kundenwunsch mit unterschiedlicher Kupplung / Equipped with different clutch according to customer requirement	(33)	
16.342 F01,02,03 28.342 F14	01.94 - 01.88 -	D2865LF	 3400 122 301 ⊗ 3482 083 032 ⊗ 1878 080 034 ⊙ 3151 000 034	430 10 MFZ430 430WGTZ KZISZ-5			
16.362 F01,02,03,U11,13 38.362 F17 48.362 VF F15 48.362 VFA 48.362 VFAK F15	01.85 - 12.92 01.89 - 07.89 - 02.90 07.89 - 02.90 07.89 - 02.90	D2866KF, KU, LXF	 3400 122 201 ⊗ 3482 083 032 ⊗ 1878 004 832 ⊙ 3151 000 034	430 10 MFZ430 430WGTZ KZISZ-5			



















		CODE					
--	--	------	--	--	---	---	---

MAN

F 90		06.86 - 12.97					
16.372 F01,02,03	01.90 -	D2866LF01/03/05	 3400 127 601 ⊗ 3482 078 133 ⊗ 1862 364 031 ⊙ 3151 000 034	400 10 MFZ400 400WGVZ KZISZ-5	Nabenprofil / Hub Profile: 2"-10N Je nach Kundenwunsch mit unterschiedlicher Kupplung / Equipped with different clutch according to customer requirement	(46)	
			 3400 122 201 ⊗ 3482 083 032 ⊗ 1878 004 832 ⊙ 3151 000 034	430 10 MFZ430 430WGTZ KZISZ-5	Je nach Kundenwunsch mit unterschiedlicher Kupplung / Equipped with different clutch according to customer requirement	(33)	
16.402 F01,02,03	01.94 -	D2866LF, D2866LF06, D2866LF/330, D2866LF09	 3400 122 201 ⊗ 3482 083 032 ⊗ 1878 004 832 ⊙ 3151 000 034	430 10 MFZ430 430WGTZ KZISZ-5			
16.422 F01,02,03,U11	01.90 -						
48.332 VF F15	07.89 - 02.90						
48.332 VFA F15	07.89 - 02.90						
48.332 VFAK F15	07.89 - 02.90						
17.462 F21,22	01.89 - 12.92	D2840LF	 3400 121 901 ⊗ 3488 017 333 ⊗ 1862 303 031 ⊙ 3151 000 034	400 10 MFZ2/400X 400WGVZ KZISZ-5	für Fahrzeuge mit Zweischeibenkupplung / for vehicles with double disc clutch Je nach Kundenwunsch mit unterschiedlicher Kupplung / Equipped with different clutch according to customer requirement	(77)	
			 3400 122 201 ⊗ 3482 083 032 ⊗ 1878 004 832 ⊙ 3151 000 034	430 10 MFZ430 430WGTZ KZISZ-5	Je nach Kundenwunsch mit unterschiedlicher Kupplung / Equipped with different clutch according to customer requirement	(33)	
22.462 F25,28	01.89 - 12.92						
25.462 F25,28	01.89 - 12.92						
32.462 F29,30	01.88 -						
17.502 F21,22	01.89 -	D2840LF01/04	 3400 121 901 ⊗ 3488 017 333 ⊗ 1862 303 031 ⊙ 3151 000 034	400 10 MFZ2/400X 400WGVZ KZISZ-5	für Fahrzeuge mit Zweischeibenkupplung / for vehicles with double disc clutch Je nach Kundenwunsch mit unterschiedlicher Kupplung / Equipped with different clutch according to customer requirement	(77)	
			 3400 122 201 ⊗ 3482 083 032 ⊗ 1878 004 832 ⊙ 3151 000 034	430 10 MFZ430 430WGTZ KZISZ-5	Je nach Kundenwunsch mit unterschiedlicher Kupplung / Equipped with different clutch according to customer requirement	(33)	
19.242 F,19.242 FL,19.242 FLL F02 F01 F03	01.88 - 01.89	D2866F	 3400 127 601 ⊗ 3482 078 133 ⊗ 1862 364 031 ⊙ 3151 000 034	400 10 MFZ400 400WGVZ KZISZ-5	F01,02,03,04 Nabenprofil / Hub Profile: 2"-10N	(46)	
	01.88 - 02.89						
	01.88 - 01.89		 3400 700 310 ⊗ 3482 078 133 ⊗ 1862 364 133 ⊙ 3151 000 034	400 10 MFZ400 400WGVZ KZISZ-5	F01,02,03,04 Nabenprofil / Hub Profile: 1 3/4"-10N	(46)	
		D2866	 1882 017 131	420 GF420XN	für Nebenantrieb / for PTO	(82)	
			 1878 086 941	420 10 420WGTZ	für Nebenantrieb / for PTO	(82)	
19.262 F,19.262 FL,19.262 FLL F01 F02 F03	01.88 - 02.90	D2865LF	 3400 127 601 ⊗ 3482 078 133 ⊗ 1862 364 031 ⊙ 3151 000 034	400 10 MFZ400 400WGVZ KZISZ-5	F01,02,03,04 Nabenprofil / Hub Profile: 2"-10N	(46)	
	02.89 - 02.90						
	02.89 - 02.90		 3400 700 310 ⊗ 3482 078 133 ⊗ 1862 364 133 ⊙ 3151 000 034	400 10 MFZ400 400WGVZ KZISZ-5	F01,02,03,04 Nabenprofil / Hub Profile: 1 3/4"-10N	(46)	
	02.89 - 02.90	D2865	 1882 017 131	420 GF420XN	für Nebenantrieb / for PTO	(82)	
	01.88 - 02.90		 1878 086 941	420 10 420WGTZ	für Nebenantrieb / for PTO	(82)	
19.262 FA F04	02.89 - 02.90						
19.262 FAK F04	02.89 - 02.90						
19.262 FAS F04	02.89 - 02.90						
19.262 FK F01	01.88 - 02.90						
19.262 FS,19.262 FLS,19.262 FLLS F03 F01 F02	01.88 - 02.90						















MAN

F 90							06.86 - 12.97	
19.272 F,19.272 FL,19.272 FLL F01 F02 F03 19.272 FA F04 19.272 FAK F04 19.272 FAS F04 19.272 FK F01 19.272 FS,19.272 FLS,19.272 FLLS F02 F01 F03	02.90 - 05.95	D2865LF01, 02, 04, 05		3400 127 601 ⊙ 3482 078 133 ⊙ 1862 364 031 ⊙ 3151 000 034	400 10 MFZ400 400WGVZ KZISZ-5	F01,02,03,04 Nabenprofil / Hub Profile: 2"-10N	(46)	
	02.90 - 05.95				3400 700 310 ⊙ 3482 078 133 ⊙ 1862 364 133 ⊙ 3151 000 034	400 10 MFZ400 400WGVZ KZISZ-5	F01,02,03,04 Nabenprofil / Hub Profile: 1 3/4"-10N	(46)
19.272 FAK F04 19.272 FAS F04 19.272 FK F01 19.272 FS,19.272 FLS,19.272 FLLS F02 F01 F03	02.90 - 05.95	D2865		1882 017 131	420 GF420XN	für Nebenantrieb / for PTO	(82)	
	02.90 - 05.95				1878 086 941	420 10 420WGTZ	für Nebenantrieb / for PTO	(82)
19.292 F,19.292 FL,19.292 FLL F02 F03 F01 19.292 FA F04 19.292 FAK F04 19.292 FAS F04 19.292 FK F01 19.292 FS,19.292 FLS,19.292 FLLS F03 F02 F01	07.86 - 02.90	D2865LF, D2866LF07		3400 127 601 ⊙ 3482 078 133 ⊙ 1862 364 031 ⊙ 3151 000 034	400 10 MFZ400 400WGVZ KZISZ-5	F01,02,03,04 Nabenprofil / Hub Profile: 2"-10N Je nach Kundenwunsch mit unterschiedlicher Kupplung / Equipped with different clutch according to customer requirement	(46) (33)	
	05.88 - 02.90				3400 700 310 ⊙ 3482 078 133 ⊙ 1862 364 133 ⊙ 3151 000 034	400 10 MFZ400 400WGVZ KZISZ-5	F01,02,03,04 Nabenprofil / Hub Profile: 1 3/4"-10N	(46)
	05.88 - 02.90				3400 122 201 ⊙ 3482 083 032 ⊙ 1878 004 832 ⊙ 3151 000 034	430 10 MFZ430 430WGTZ KZISZ-5	F01,02,03,04 Je nach Kundenwunsch mit unterschiedlicher Kupplung / Equipped with different clutch according to customer requirement	(33)
	07.86 - 02.90				1882 017 131	420 GF420XN	für Nebenantrieb / for PTO	(82)
19.302 F01,02,03,04	01.90 - 12.92	D2866LF04		3400 127 601 ⊙ 3482 078 133 ⊙ 1862 364 031 ⊙ 3151 000 034	400 10 MFZ400 400WGVZ KZISZ-5	Nabenprofil / Hub Profile: 2"-10N	(46)	
					1882 017 131	420 GF420XN	Nebenantriebs-ID / PTO ID: 130E	(48)
19.322 F,19.322 FL,19.322 FLL F02 F03 F01 19.322 FA F04 19.322 FAK F04 19.322 FAS F04 19.322 FK F01 19.322 FS,19.322 FLS,19.322 FLLS F03 F02 F01	02.90 - 05.95	D2865LF03, 06		3400 127 601 ⊙ 3482 078 133 ⊙ 1862 364 031 ⊙ 3151 000 034	400 10 MFZ400 400WGVZ KZISZ-5	->07.1993 F01,02,03,04,U11 Nabenprofil / Hub Profile: 2"-10N	(46)	
	02.90 - 06.96				3400 122 301 ⊙ 3482 083 032 ⊙ 1878 080 034 ⊙ 3151 000 034	430 10 MFZ430 430WGTZ KZISZ-5	08.1993-> F01,02,03,04,U11	
	02.90 - 06.96				1882 017 131	420 GF420XN	für Nebenantrieb / for PTO	(82)
	02.90 - 05.95				1878 086 941	420 10 420WGTZ	für Nebenantrieb / for PTO	(82)
19.332 F,19.332 FL,19.332 FLL F01 F02 F03 19.332 FA F04 19.332 FAK F04 19.332 FAS F04 19.332 FK F01 19.332 FS,19.332 FLS,19.332 FLLS F02 F03 F01	07.86 - 02.90	D2866LF08		3400 127 601 ⊙ 3482 078 133 ⊙ 1862 364 031 ⊙ 3151 000 034	400 10 MFZ400 400WGVZ KZISZ-5	F01,02,03,04 Nabenprofil / Hub Profile: 2"-10N Je nach Kundenwunsch mit unterschiedlicher Kupplung / Equipped with different clutch according to customer requirement	(46) (33)	
	05.88 - 02.90				3400 122 201 ⊙ 3482 083 032 ⊙ 1878 004 832 ⊙ 3151 000 034	430 10 MFZ430 430WGTZ KZISZ-5	F01,02,03,04 Je nach Kundenwunsch mit unterschiedlicher Kupplung / Equipped with different clutch according to customer requirement	(33)
	05.88 - 02.90				1882 017 131	420 GF420XN	für Nebenantrieb / for PTO	(82)
	07.86 - 02.90				1878 086 941	420 10 420WGTZ	für Nebenantrieb / for PTO	(82)

F 90		06.86 - 12.97					
19.342 F,19.342 FL,19.342 FLL F03 F01 F02	05.94 - 05.95	D2865LF		3400 122 301 ⊗ 3482 083 032 ⊗ 1878 080 034 ⊙ 3151 000 034	430 10 MFZ430 430WGTZ KZISZ-5	F01,02,03,04	
19.342 FA F04	05.94 - 06.96						
19.342 FAK F04	05.94 - 06.96						
19.342 FAS F04	05.94 - 06.96						
19.342 FK F01	05.94 - 05.95						
19.342 FS,19.342 FLS,19.342 FLLS F01 F03 F02	05.94 - 05.95						
19.362 F,19.362 FL,19.362 FLL F01 F03 F02	07.86 - 02.90	D2865LF		3400 127 601 ⊗ 3482 078 133 ⊗ 1862 364 031 ⊙ 3151 000 034	400 10 MFZ400 400WGVZ KZISZ-5	F01,02,03,04 Nabenprofil / Hub Profile: 2"-10N	(46)
19.362 FA F04	05.88 - 02.90						
19.362 FAK F04	05.88 - 02.90			3400 700 310 ⊗ 3482 078 133 ⊗ 1862 364 133 ⊙ 3151 000 034	400 10 MFZ400 400WGVZ KZISZ-5	F01,02,03,04 Nabenprofil / Hub Profile: 1 3/4"-10N	(46)
19.362 FAS F04	05.88 - 02.90						
		D2866KF		3400 122 201 ⊗ 3482 083 032 ⊗ 1878 004 832 ⊙ 3151 000 034	430 10 MFZ430 430WGTZ KZISZ-5	F01,02,03,04	
		D2865, D2866		1882 017 131	420 GF420XN	für Nebenantrieb / for PTO	(82)
				1878 086 941	420 10 420WGTZ	für Nebenantrieb / for PTO	(82)
19.362 FK F01	07.86 - 02.90	D2866KF		3400 122 201 ⊗ 3482 083 032 ⊗ 1878 004 832 ⊙ 3151 000 034	430 10 MFZ430 430WGTZ KZISZ-5	F01,02,03,04	
19.362 FS,19.362 FLS,19.362 FLLS F02 F03 F01	07.86 - 02.90	D2866		1882 017 131	420 GF420XN	für Nebenantrieb / for PTO	(82)
				1878 086 941	420 10 420WGTZ	für Nebenantrieb / for PTO	(82)
19.372 F,19.372 FL,19.372 FLL F01 F02 F03	05.90 - 04.95	D2866LXF		3400 127 601 ⊗ 3482 078 133 ⊗ 1862 364 031 ⊙ 3151 000 034	400 10 MFZ400 400WGVZ KZISZ-5	Nabenprofil / Hub Profile: 2"-10N Je nach Kundenwunsch mit unterschiedlicher Kupplung / Equipped with different clutch according to customer requirement	(46) (33)
19.372 FK F01	05.90 - 04.95						
19.372 FS,19.372 FLS,19.372 FLLS F01 F03 F02	05.90 - 04.95			3400 122 201 ⊗ 3482 083 032 ⊗ 1878 004 832 ⊙ 3151 000 034	430 10 MFZ430 430WGTZ KZISZ-5	Je nach Kundenwunsch mit unterschiedlicher Kupplung / Equipped with different clutch according to customer requirement	(33)
25.372 DF F08	09.90 - 12.92			3400 121 901 ⊗ 3488 017 333 ⊗ 1862 303 031 ⊙ 3151 000 034	400 10 MFZ2/400X 400WGVZ KZISZ-5	für Fahrzeuge mit Zweischeibenkupplung / for vehicles with double disc clutch Je nach Kundenwunsch mit unterschiedlicher Kupplung / Equipped with different clutch according to customer requirement	(77) (33)
25.372 DFK F08	09.90 - 12.92						
25.372 DFS F08	09.90 - 12.92			1882 017 131	420 GF420XN	für Nebenantrieb / for PTO	(82)
25.372 FVLS F07	09.90 - 10.93			1878 086 941	420 10 420WGTZ	für Nebenantrieb / for PTO	(82)
				3151 204 001	KZI-6	für Nebenantrieb / for PTO mit Schmierrohranschluß / with lubricating pipe coupling	(82) (91)
19.372 F,19.372 FL,19.372 FLL F02 F01 F03	02.90 - 05.95	D2866LF01, 03, 05		3400 127 601 ⊗ 3482 078 133 ⊗ 1862 364 031 ⊙ 3151 000 034	400 10 MFZ400 400WGVZ KZISZ-5	F01,02,03,04 Nabenprofil / Hub Profile: 2"-10N Je nach Kundenwunsch mit unterschiedlicher Kupplung / Equipped with different clutch according to customer requirement	(46) (33)
19.372 FA F04	02.90 - 06.96						
19.372 FAK F04	02.90 - 06.96			3400 122 201 ⊗ 3482 083 032 ⊗ 1878 004 832 ⊙ 3151 000 034	430 10 MFZ430 430WGTZ KZISZ-5	F01,02,03,04 Je nach Kundenwunsch mit unterschiedlicher Kupplung / Equipped with different clutch according to customer requirement	(33)
19.372 FAS F04	02.90 - 06.96						
19.372 FK F01	02.90 - 05.95	D2866		1882 017 131	420 GF420XN	für Nebenantrieb / for PTO	(82)
19.372 FS,19.372 FLS,19.372 FLLS F03 F02 F01	02.90 - 05.95			1878 086 941	420 10 420WGTZ	für Nebenantrieb / for PTO	(82)

















		CODE				
--	--	------	--	---	---	---

MAN

F 90		06.86 - 12.97					
19.402 F,19.402 FL,19.402 FLL F01 F03 F02	05.94 - 05.95	D2866LF		3400 122 201 ⊗ 3482 083 032 ⊗ 1878 004 832 ⊙ 3151 000 034	430 10 MFZ430 430WGTZ KZISZ-5	F01,02,03,04	
19.402 FA F04	05.94 - 06.96						
19.402 FAK F04	05.94 - 06.96						
19.402 FAS F04	05.94 - 06.96						
19.402 FK F01	05.94 - 05.95						
19.402 FS,19.402 FLS,19.402 FLLS F01 F03 F02	05.94 - 05.95						
19.422 F,19.422 FL,19.422 FLL F01 F03 F02	02.90 - 05.95	D2866LF06, 09		3400 122 201 ⊗ 3482 083 032 ⊗ 1878 004 832 ⊙ 3151 000 034	430 10 MFZ430 430WGTZ KZISZ-5	F01,02,03,04,U11	
19.422 FA F04	02.90 - 06.96						
19.422 FAK F04	02.90 - 06.96	D2866		1882 017 131	420 GF420XN	für Nebenantrieb / for PTO	(82)
19.422 FAS F04	02.90 - 06.96			1878 086 941	420 10 420WGTZ	für Nebenantrieb / for PTO	(82)
19.422 FK F01	02.90 - 05.95			3151 204 001	KZI-6	für Nebenantrieb / for PTO mit Schmierrohranschluß / with lubricating pipe coupling	(82) (91)
19.422 FS,19.422 FLS,19.422 FLLS F01 F03 F02	02.90 - 05.95						
19.432 23.372 F20 24.372 F20	01.94 - 01.88 - 07.93 -	D2866LF03		3400 122 201 ⊗ 3482 083 032 ⊗ 1878 004 832 ⊙ 3151 000 034	430 10 MFZ430 430WGTZ KZISZ-5		
19.462 F,19.462 FL F01 F02	05.87 - 02.90	D2840LF		3400 122 201 ⊗ 3482 083 032 ⊗ 1878 004 832 ⊙ 3151 000 034	430 10 MFZ430 430WGTZ KZISZ-5	->07.1989 F01,02	
19.462 FK F01	05.87 - 02.90						
19.462 FS,19.462 FLS F01 F02	05.87 - 02.90			3400 121 901 ⊗ 3488 017 333 ⊗ 1862 303 031 ⊙ 3151 000 034	400 10 MFZ2/400X 400WGVZ KZISZ-5	08.1989-> F01,02 für Fahrzeuge mit Zweis Scheibenkupplung / for vehicles with double disc clutch	(77)
		D2840		1882 017 131	420 GF420XN	für Nebenantrieb / for PTO	(82)
				1878 086 941	420 10 420WGTZ	für Nebenantrieb / for PTO	(82)
19.502 F,19.502 FL,19.502 FLL F22 F21 F23	02.90 - 06.96	D2840LF01, 04		3400 122 201 ⊗ 3482 083 032 ⊗ 1878 004 832 ⊙ 3151 000 034	430 10 MFZ430 430WGTZ KZISZ-5	F21,22 Je nach Kundenwunsch mit unterschiedlicher Kupplung / Equipped with different clutch according to customer requirement	(33)
19.502 FS,19.502 FLS,19.502 FLLS F21 F23 F22	02.90 - 06.96			3400 121 901 ⊗ 3488 017 333 ⊗ 1862 303 031 ⊙ 3151 000 034	400 10 MFZ2/400X 400WGVZ KZISZ-5	F21,22 für Fahrzeuge mit Zweis Scheibenkupplung / for vehicles with double disc clutch Je nach Kundenwunsch mit unterschiedlicher Kupplung / Equipped with different clutch according to customer requirement	(77) (33)
22.242 F05,06,07,08,16	01.88 -	D2866LF, D2865LF		3400 700 310 ⊗ 3482 078 133 ⊗ 1862 364 133 ⊙ 3151 000 034	400 10 MFZ400 400WGVZ KZISZ-5	Nabenprofil / Hub Profile: 1 3/4"-10N Je nach Kundenwunsch mit unterschiedlicher Kupplung / Equipped with different clutch according to customer requirement	(46) (33)
22.262 F05,06,07,08,16	01.88 -						
22.272 F05,06,07,08,16	01.90 -			3400 121 901 ⊗ 3488 017 333 ⊗ 1862 303 031 ⊙ 3151 000 034	400 10 MFZ2/400X 400WGVZ KZISZ-5	für Fahrzeuge mit Zweis Scheibenkupplung / for vehicles with double disc clutch Je nach Kundenwunsch mit unterschiedlicher Kupplung / Equipped with different clutch according to customer requirement	(77) (33)
25.242 F05,06,07,08,16	01.88 -						
25.262 F05,06,07,08,16	01.88 -						















		CODE				
--	--	------	--	---	---	---

MAN

F 90		06.86 - 12.97					
22.292 F05,06,07,08,16 25.292 F05,06,07,08,16	01.86 - 12.92	D2866LF07	 3400 127 601 ● 3482 078 133 ● 1862 364 031 ● 3151 000 034	400 10 MFZ400 400WGVZ KZISZ-5	Nabenprofil / Hub Profile: 2"-10N Je nach Kundenwunsch mit unterschiedlicher Kupplung / Equipped with different clutch according to customer requirement	(46) (33)	
	01.86 - 12.92		 3400 122 201 ● 3482 083 032 ● 1878 004 832 ● 3151 000 034	430 10 MFZ430 430WGTZ KZISZ-5	Je nach Kundenwunsch mit unterschiedlicher Kupplung / Equipped with different clutch according to customer requirement	(33)	
			 3400 121 901 ● 3488 017 333 ● 1862 303 031 ● 3151 000 034	400 10 MFZ2/400X 400WGVZ KZISZ-5	für Fahrzeuge mit Zweischeibenkupplung / for vehicles with double disc clutch Je nach Kundenwunsch mit unterschiedlicher Kupplung / Equipped with different clutch according to customer requirement	(77) (33)	
22.302 F05,06,07,08,16 22.322 F05,06,07,08,16	01.90 - 12.92	D2865LF03, D2865LF06, D2866LF04	 3400 127 601 ● 3482 078 133 ● 1862 364 031 ● 3151 000 034	400 10 MFZ400 400WGVZ KZISZ-5	Nabenprofil / Hub Profile: 2"-10N Je nach Kundenwunsch mit unterschiedlicher Kupplung / Equipped with different clutch according to customer requirement	(46) (33)	
	01.89 -		 3400 121 901 ● 3488 017 333 ● 1862 303 031 ● 3151 000 034	400 10 MFZ2/400X 400WGVZ KZISZ-5	für Fahrzeuge mit Zweischeibenkupplung / for vehicles with double disc clutch Je nach Kundenwunsch mit unterschiedlicher Kupplung / Equipped with different clutch according to customer requirement	(77) (33)	
22.332 F05,06,07,08,16 22.372 F05,06,07,08,16 25.332 F05,06,07,08,16	01.86 -	D2866LF03, D2866LF05, D2866LF01, D2866LF08	 3400 127 601 ● 3482 078 133 ● 1862 364 031 ● 3151 000 034	400 10 MFZ400 400WGVZ KZISZ-5	Nabenprofil / Hub Profile: 2"-10N Je nach Kundenwunsch mit unterschiedlicher Kupplung / Equipped with different clutch according to customer requirement	(46) (33)	
	01.89 -		 3400 122 201 ● 3482 083 032 ● 1878 004 832 ● 3151 000 034	430 10 MFZ430 430WGTZ KZISZ-5	Je nach Kundenwunsch mit unterschiedlicher Kupplung / Equipped with different clutch according to customer requirement	(33)	
	01.86 -		 3400 121 901 ● 3488 017 333 ● 1862 303 031 ● 3151 000 034	400 10 MFZ2/400X 400WGVZ KZISZ-5	für Fahrzeuge mit Zweischeibenkupplung / for vehicles with double disc clutch Je nach Kundenwunsch mit unterschiedlicher Kupplung / Equipped with different clutch according to customer requirement	(77) (33)	
22.362 F05,06,07,08,16 25.362 F05,06,07,08,16	01.86 - 12.92	D2866KF, KU, LXF	 3400 122 201 ● 3482 083 032 ● 1878 004 832 ● 3151 000 034	430 10 MFZ430 430WGTZ KZISZ-5	Je nach Kundenwunsch mit unterschiedlicher Kupplung / Equipped with different clutch according to customer requirement	(33)	
	01.86 -		 3400 121 901 ● 3488 017 333 ● 1862 303 031 ● 3151 000 034	400 10 MFZ2/400X 400WGVZ KZISZ-5	für Fahrzeuge mit Zweischeibenkupplung / for vehicles with double disc clutch Je nach Kundenwunsch mit unterschiedlicher Kupplung / Equipped with different clutch according to customer requirement	(77) (33)	
22.422 F05,06,07,08,16	01.89 -	D2866LF06, 09	 3400 122 201 ● 3482 083 032 ● 1878 004 832 ● 3151 000 034	430 10 MFZ430 430WGTZ KZISZ-5	Je nach Kundenwunsch mit unterschiedlicher Kupplung / Equipped with different clutch according to customer requirement	(33)	
			 3400 121 901 ● 3488 017 333 ● 1862 303 031 ● 3151 000 034	400 10 MFZ2/400X 400WGVZ KZISZ-5	für Fahrzeuge mit Zweischeibenkupplung / for vehicles with double disc clutch Je nach Kundenwunsch mit unterschiedlicher Kupplung / Equipped with different clutch according to customer requirement	(77) (33)	
22.502 F25,28,36 32.502 F29,30	01.90 -	D2840LF01, 04	 3400 122 201 ● 3482 083 032 ● 1878 004 832 ● 3151 000 034	430 10 MFZ430 430WGTZ KZISZ-5	Je nach Kundenwunsch mit unterschiedlicher Kupplung / Equipped with different clutch according to customer requirement	(33)	
	01.90 -		 3400 121 901 ● 3488 017 333 ● 1862 303 031 ● 3151 000 034	400 10 MFZ2/400X 400WGVZ KZISZ-5	für Fahrzeuge mit Zweischeibenkupplung / for vehicles with double disc clutch Je nach Kundenwunsch mit unterschiedlicher Kupplung / Equipped with different clutch according to customer requirement	(77) (33)	
23.272 F20 23.322 F20		D2865LF02, D2865LF04, D2865LF03, D2865LF05	 3400 127 601 ● 3482 078 133 ● 1862 364 031 ● 3151 000 034	400 10 MFZ400 400WGVZ KZISZ-5	01.1992 - 06.1993 Nabenprofil / Hub Profile: 2"-10N	(46)	
			 3400 122 301 ● 3482 083 032 ● 1878 080 034 ● 3151 000 034	430 10 MFZ430 430WGTZ KZISZ-5	07.1993->		
23.342 F20 24.342 F20	01.94 -	D2865LF21	 3400 122 301 ● 3482 083 032 ● 1878 080 034 ● 3151 000 034	430 10 MFZ430 430WGTZ KZISZ-5			
	01.94 -						

















		CODE				
--	--	------	--	---	---	---

MAN

F 90		06.86 - 12.97					
23.372 F20	-06.93	D2866LF03		3400 127 601 ⊗ 3482 078 133 ⊗ 1862 364 031 ⊖ 3151 000 034	400 10 MFZ400 400WGVZ KZISZ-5	Nabenprofil / Hub Profile: 2"-10N	(46)
24.372 F20	01.92-06.93						
23.422 F20	01.92-	D2866LF06, 09		3400 122 201 ⊗ 3482 083 032 ⊗ 1878 004 832 ⊖ 3151 000 034	430 10 MFZ430 430WGTZ KZISZ-5		
27.422 F09,10	01.90-						
28.422 F09,13,14	01.90-						
30.422 F13,14	01.90-						
31.422 F13,14	01.90-						
38.422 F17	01.89-						
24.242 DF F08	01.88-07.89	D2866F		3400 127 601 ⊗ 3482 078 133 ⊗ 1862 364 031 ⊖ 3151 000 034	400 10 MFZ400 400WGVZ KZISZ-5	F05,06,07,08,16 Nabenprofil / Hub Profile: 2"-10N	(46)
24.242 DFK F08	01.88-07.89					Je nach Kundenwunsch mit unterschiedlicher Kupplung / Equipped with different clutch according to customer requirement	(33)
24.242 DFS F08	01.88-07.89			3400 700 310 ⊗ 3482 078 133 ⊗ 1862 364 133 ⊖ 3151 000 034	400 10 MFZ400 400WGVZ KZISZ-5	F05,06,07,08,16 Nabenprofil / Hub Profile: 1 3/4"-10N	(46)
24.242 FNL,24.242 FNLL,24.242 FVL F05 F06 F07	01.88-02.90			3400 121 901 ⊗ 3488 017 333 ⊗ 1862 303 031 ⊖ 3151 000 034	400 10 MFZ2/400X 400WGVZ KZISZ-5	F05,06,07,08,16 für Fahrzeuge mit Zweischeibenkupplung / for vehicles with double disc clutch Je nach Kundenwunsch mit unterschiedlicher Kupplung / Equipped with different clutch according to customer requirement	(77) (33)
24.262 DF F08	01.88-02.90	D2865LF		3400 127 601 ⊗ 3482 078 133 ⊗ 1862 364 031 ⊖ 3151 000 034	400 10 MFZ400 400WGVZ KZISZ-5	F05,06,07,08,16 Nabenprofil / Hub Profile: 2"-10N	(46)
24.262 DFK F08	01.88-02.90					Je nach Kundenwunsch mit unterschiedlicher Kupplung / Equipped with different clutch according to customer requirement	(33)
24.262 DFS,24.262 DFLS F08 F16	01.88-02.90			3400 700 310 ⊗ 3482 078 133 ⊗ 1862 364 133 ⊖ 3151 000 034	400 10 MFZ400 400WGVZ KZISZ-5	F05,06,07,08,16 Nabenprofil / Hub Profile: 1 3/4"-10N	(46)
24.262 FNL,24.262 FNLL,24.262 FVL F06 F05 F07	01.88-02.90			3400 121 901 ⊗ 3488 017 333 ⊗ 1862 303 031 ⊖ 3151 000 034	400 10 MFZ2/400X 400WGVZ KZISZ-5	F05,06,07,08,16 für Fahrzeuge mit Zweischeibenkupplung / for vehicles with double disc clutch Je nach Kundenwunsch mit unterschiedlicher Kupplung / Equipped with different clutch according to customer requirement	(77) (33)
24.272 DF F08	02.90-12.90	D2865LF01, 02, 04, 05		3400 127 601 ⊗ 3482 078 133 ⊗ 1862 364 031 ⊖ 3151 000 034	400 10 MFZ400 400WGVZ KZISZ-5	F05,06,07,08,16 Nabenprofil / Hub Profile: 2"-10N	(46)
24.272 DFK F08	02.90-12.90					Je nach Kundenwunsch mit unterschiedlicher Kupplung / Equipped with different clutch according to customer requirement	(33)
24.272 DFS,24.272 DFLS F08 F16	02.90-04.95			3400 700 310 ⊗ 3482 078 133 ⊗ 1862 364 133 ⊖ 3151 000 034	400 10 MFZ400 400WGVZ KZISZ-5	F05,06,07,08,16 Nabenprofil / Hub Profile: 1 3/4"-10N	(46)
24.272 FNL,24.272 FNLL,24.272 FVL F05 F06 F18 F07 F19	02.90-05.95			3400 121 901 ⊗ 3488 017 333 ⊗ 1862 303 031 ⊖ 3151 000 034	400 10 MFZ2/400X 400WGVZ KZISZ-5	F05,06,07,08,16 für Fahrzeuge mit Zweischeibenkupplung / for vehicles with double disc clutch Je nach Kundenwunsch mit unterschiedlicher Kupplung / Equipped with different clutch according to customer requirement	(77) (33)
24.272 FNLS,24.272 FVLS F07 F05 F18	02.90-05.95						
		D2865		1882 017 131	420 GF420XN	07.1990-> für Nebenantrieb / for PTO	(82)
				1878 086 941	420 10 420WGTZ	07.1990-> für Nebenantrieb / for PTO	(82)
				3151 204 001	KZI-6	07.1990-> für Nebenantrieb / for PTO mit Schmierrohranschluß / with lubricating pipe coupling	(82) (91)

















		CODE				
--	--	------	--	---	---	---

MAN

F 90		06.86 - 12.97					
24.292 DF F08 24.292 DFK F08 24.292 DFS,24.292 DFLS F16 F08 24.292 FNL,24.292 FNLL,24.292 FVL F06 F05 F07 24.292 FNLS,24.292 FVLS F05 F07	04.87 - 02.90	D2866LF07	 3400 127 601 ⊗ 3482 078 133 ⊗ 1862 364 031 ⊙ 3151 000 034	400 10 MFZ400 400WGVZ KZISZ-5	F05,06,07,08,16 Nabenprofil / Hub Profile: 2"-10N Je nach Kundenwunsch mit unterschiedlicher Kupplung / Equipped with different clutch according to customer requirement	(46) (33)	
	04.87 - 02.90		 3400 122 201 ⊗ 3482 083 032 ⊗ 1878 004 832 ⊙ 3151 000 034	430 10 MFZ430 430WGTZ KZISZ-5	F05,06,07,08,16 Je nach Kundenwunsch mit unterschiedlicher Kupplung / Equipped with different clutch according to customer requirement	(33)	
	10.86 - 02.90		 3400 121 901 ⊗ 3488 017 333 ⊗ 1862 303 031 ⊙ 3151 000 034	400 10 MFZ2/400X 400WGVZ KZISZ-5	F05,06,07,08,16 für Fahrzeuge mit Zweischeibenkupplung / for vehicles with double disc clutch Je nach Kundenwunsch mit unterschiedlicher Kupplung / Equipped with different clutch according to customer requirement	(77) (33)	
24.302 DF F08 24.302 DFK F08 24.302 DFS,24.302 DFLS F08 F16 24.302 FNL,24.302 FNLL,24.302 FVL F07 F05 F06	05.90 - 12.90	D2866LF04	 3400 127 601 ⊗ 3482 078 133 ⊗ 1862 364 031 ⊙ 3151 000 034	400 10 MFZ400 400WGVZ KZISZ-5	Nabenprofil / Hub Profile: 2"-10N	(46)	
	05.90 - 04.95		 3400 121 901 ⊗ 3488 017 333 ⊗ 1862 303 031 ⊙ 3151 000 034	400 10 MFZ2/400X 400WGVZ KZISZ-5	F05,06,07,08,16 für Fahrzeuge mit Zweischeibenkupplung / for vehicles with double disc clutch Je nach Kundenwunsch mit unterschiedlicher Kupplung / Equipped with different clutch according to customer requirement	(77) (33)	
	05.90 - 10.90	D2866	 1882 017 131	420 GF420XN	07.1990-> für Nebenantrieb / for PTO	(82)	
			 1878 086 941	420 10 420WGTZ	07.1990-> für Nebenantrieb / for PTO	(82)	
			 3151 204 001	KZI-6	07.1990-> für Nebenantrieb / for PTO mit Schmierrohranschluß / with lubricating pipe coupling	(82) (91)	
24.322 F20		D2865LF03	 3400 127 601 ⊗ 3482 078 133 ⊗ 1862 364 031 ⊙ 3151 000 034	400 10 MFZ400 400WGVZ KZISZ-5	01.1992 - 06.1993 Nabenprofil / Hub Profile: 2"-10N Je nach Kundenwunsch mit unterschiedlicher Kupplung / Equipped with different clutch according to customer requirement	(46) (33)	
			 3400 121 901 ⊗ 3488 017 333 ⊗ 1862 303 031 ⊙ 3151 000 034	400 10 MFZ2/400X 400WGVZ KZISZ-5	01.1992 - 06.1993 für Fahrzeuge mit Zweischeibenkupplung / for vehicles with double disc clutch Je nach Kundenwunsch mit unterschiedlicher Kupplung / Equipped with different clutch according to customer requirement	(77) (33)	
		D2865LF03, 06	 3400 122 301 ⊗ 3482 083 032 ⊗ 1878 080 034 ⊙ 3151 000 034	430 10 MFZ430 430WGTZ KZISZ-5	07.1993->		
24.322 DF F08 24.322 DFK F08 24.322 DFS,24.322 DFLS F08 F16 24.322 FNL,24.322 FNLL,24.322 FVL F07 F18 F05 F06 F19 24.322 FNLS,24.322 FVLS F07 F05 F18	02.90 - 12.90	D2865LF03, 06	 3400 127 601 ⊗ 3482 078 133 ⊗ 1862 364 031 ⊙ 3151 000 034	400 10 MFZ400 400WGVZ KZISZ-5	F05,06,07,08,16 Nabenprofil / Hub Profile: 2"-10N Je nach Kundenwunsch mit unterschiedlicher Kupplung / Equipped with different clutch according to customer requirement	(46) (33)	
	02.90 - 12.90		 3400 121 901 ⊗ 3488 017 333 ⊗ 1862 303 031 ⊙ 3151 000 034	400 10 MFZ2/400X 400WGVZ KZISZ-5	F05,06,07,08,16 für Fahrzeuge mit Zweischeibenkupplung / for vehicles with double disc clutch Je nach Kundenwunsch mit unterschiedlicher Kupplung / Equipped with different clutch according to customer requirement	(77) (33)	
	02.90 - 05.95		D2865	 1882 017 131	420 GF420XN	07.1990-> für Nebenantrieb / for PTO	(82)
	02.90 - 05.95	 1878 086 941		420 10 420WGTZ	07.1990-> für Nebenantrieb / for PTO	(82)	
	02.90 - 05.95	 3151 204 001		KZI-6	07.1990-> für Nebenantrieb / for PTO mit Schmierrohranschluß / with lubricating pipe coupling	(82) (91)	







		CODE				
--	--	------	--	---	---	---

MAN

F 90		06.86 - 12.97					
24.332 DF F08 24.332 DFK F08 24.332 DFS,24.332 DFSL F16 F08 24.332 FNL,24.332 FNLL,24.332 FVL F06 F07 F05 24.332 FNLS,24.332 FVLS F07 F05	04.87 - 02.90	D2866LF08	 3400 127 601 ⊗ 3482 078 133 ⊗ 1862 364 031 ⊙ 3151 000 034	400 10 MFZ400 400WGVZ KZISZ-5	F05,06,07,08,16 Nabenprofil / Hub Profile: 2"-10N Je nach Kundenwunsch mit unterschiedlicher Kupplung / Equipped with different clutch according to customer requirement	(46) (33)	
	04.87 - 02.90		 3400 122 201 ⊗ 3482 083 032 ⊗ 1878 004 832 ⊙ 3151 000 034	430 10 MFZ430 430WGTZ KZISZ-5	F05,06,07,08,16 Je nach Kundenwunsch mit unterschiedlicher Kupplung / Equipped with different clutch according to customer requirement	(33)	
	10.86 - 02.90		 3400 121 901 ⊗ 3488 017 333 ⊗ 1862 303 031 ⊙ 3151 000 034	400 10 MFZ2/400X 400WGVZ KZISZ-5	F05,06,07,08,16 für Fahrzeuge mit Zweischeibenkupplung / for vehicles with double disc clutch Je nach Kundenwunsch mit unterschiedlicher Kupplung / Equipped with different clutch according to customer requirement	(77) (33)	
24.342 FNL,24.342 FNLL F18 F19	05.94 - 05.95	D2865LF09	 3400 122 301 ⊗ 3482 083 032 ⊗ 1878 080 034 ⊙ 3151 000 034	430 10 MFZ430 430WGTZ KZISZ-5			
			 3400 121 901 ⊗ 3488 017 333 ⊗ 1862 303 031 ⊙ 3151 000 034	400 10 MFZ2/400X 400WGVZ KZISZ-5	für Fahrzeuge mit Zweischeibenkupplung / for vehicles with double disc clutch	(77)	
24.362 DF F08 24.362 DFK F08 24.362 DFS,24.362 DFSL F08 F16 24.362 FNL,24.362 FNLL,24.362 FVL F07 F05 F06 24.362 FNLS,24.362 FVLS F05 F07	04.87 - 02.90	D2866KF, KU, LXF	 3400 122 201 ⊗ 3482 083 032 ⊗ 1878 004 832 ⊙ 3151 000 034	430 10 MFZ430 430WGTZ KZISZ-5	F05,06,07,08 Je nach Kundenwunsch mit unterschiedlicher Kupplung / Equipped with different clutch according to customer requirement	(33)	
	04.87 - 02.90		 3400 121 901 ⊗ 3488 017 333 ⊗ 1862 303 031 ⊙ 3151 000 034	400 10 MFZ2/400X 400WGVZ KZISZ-5	F05,06,07,08 für Fahrzeuge mit Zweischeibenkupplung / for vehicles with double disc clutch Je nach Kundenwunsch mit unterschiedlicher Kupplung / Equipped with different clutch according to customer requirement	(77) (33)	
	04.87 - 02.90						
	10.86 - 02.90	D2866	 1882 017 131	420 GF420XN	für Nebenantrieb / for PTO	(82)	
	10.86 - 02.90		 1878 086 941	420 10 420WGTZ	für Nebenantrieb / for PTO	(82)	
	10.86 - 02.90		 3151 204 001	KZI-6	für Nebenantrieb / for PTO mit Schmierrohranschluß / with lubricating pipe coupling	(82) (91)	
24.372 DF F08 24.372 DFK F08 24.372 DFS F08 24.372 FVL F07 24.372 FVLS F07	05.90 - 12.90	D2866LXF	 3400 127 601 ⊗ 3482 078 133 ⊗ 1862 364 031 ⊙ 3151 000 034	400 10 MFZ400 400WGVZ KZISZ-5	Nabenprofil / Hub Profile: 2"-10N Je nach Kundenwunsch mit unterschiedlicher Kupplung / Equipped with different clutch according to customer requirement	(46) (33)	
	05.90 - 12.90		 3400 122 201 ⊗ 3482 083 032 ⊗ 1878 004 832 ⊙ 3151 000 034	430 10 MFZ430 430WGTZ KZISZ-5	Je nach Kundenwunsch mit unterschiedlicher Kupplung / Equipped with different clutch according to customer requirement	(33)	
	05.90 - 12.90		 3400 121 901 ⊗ 3488 017 333 ⊗ 1862 303 031 ⊙ 3151 000 034	400 10 MFZ2/400X 400WGVZ KZISZ-5	für Fahrzeuge mit Zweischeibenkupplung / for vehicles with double disc clutch Je nach Kundenwunsch mit unterschiedlicher Kupplung / Equipped with different clutch according to customer requirement	(77) (33)	
	05.90 - 12.90		 1882 017 131	420 GF420XN	für Nebenantrieb / for PTO	(82)	
	05.90 - 12.90		 1878 086 941	420 10 420WGTZ	für Nebenantrieb / for PTO	(82)	
	05.90 - 12.90		 3151 204 001	KZI-6	für Nebenantrieb / for PTO mit Schmierrohranschluß / with lubricating pipe coupling	(82) (91)	
	05.90 - 12.90						







MAN

F 90		06.86 - 12.97				
24.372 DF F16 F08 24.372 DFS, 24.372 DFLS F08 F16	02.90 - 12.90	D2866LF01, 03, 05	 3400 127 601 ⚙ 3482 078 133 ⚙ 1862 364 031 ⚙ 3151 000 034	400 10 MFZ400 400WGVZ KZISZ-5	F05,06,07,08,16 Nabenprofil / Hub Profile: 2"-10N Je nach Kundenwunsch mit unterschiedlicher Kupplung / Equipped with different clutch according to customer requirement	(46) (33)
	02.90 - 04.95		 3400 122 201 ⚙ 3482 083 032 ⚙ 1878 004 832 ⚙ 3151 000 034	430 10 MFZ430 430WGTZ KZISZ-5	F05,06,07,08,16 Je nach Kundenwunsch mit unterschiedlicher Kupplung / Equipped with different clutch according to customer requirement	(33)
			 3400 121 901 ⚙ 3488 017 333 ⚙ 1862 303 031 ⚙ 3151 000 034	400 10 MFZ2/400X 400WGVZ KZISZ-5	F05,06,07,08,16 für Fahrzeuge mit Zweis Scheibenkupplung / for vehicles with double disc clutch Je nach Kundenwunsch mit unterschiedlicher Kupplung / Equipped with different clutch according to customer requirement	(77) (33)
	D2866	 1882 017 131	420 GF420XN	07.1990-> für Nebenantrieb / for PTO	(82)	
		 1878 086 941	420 10 420WGTZ	07.1990-> für Nebenantrieb / for PTO	(82)	
		 3151 204 001	KZI-6	07.1990-> für Nebenantrieb / for PTO mit Schmierrohranschluß / with lubricating pipe coupling	(82) (91)	













		CODE				
--	--	------	--	---	---	---

MAN

F 90		06.86 - 12.97					
24.372 DFK F08	02.90 - 12.90	D2866LF/290, D2865LF03, D2866LF03,	 3400 127 601 ⊗ 3482 078 133 ⊗ 1862 364 031 ⊙ 3151 000 034	400 10 MFZ400 400WGVZ KZISZ-5	Nabenprofil / Hub Profile: 2"-10N Je nach Kundenwunsch mit unterschiedlicher Kupplung / Equipped with different clutch according to customer requirement	(46) (33)	
24.372 FNL,24.372 FNLL,24.372 FVL F06 F07 F18 F19 F05	02.90 - 05.95	D2866LFZ/330, D2865LF06, D2866LF05,	 3400 122 201 ⊗ 3482 083 032 ⊗ 1878 004 832 ⊙ 3151 000 034	430 10 MFZ430 430WGTZ KZISZ-5	Je nach Kundenwunsch mit unterschiedlicher Kupplung / Equipped with different clutch according to customer requirement	(33)	
24.372 FNLS,24.372 FVLS F07 F05 F18	02.90 - 05.95	D2866LF16, D2866LXF, D2866LF15,	 3400 121 901 ⊗ 3488 017 333 ⊗ 1862 303 031 ⊙ 3151 000 034	400 10 MFZ2/400X 400WGVZ KZISZ-5	für Fahrzeuge mit Zweischeibenkupplung / for vehicles with double disc clutch	(77)	
24.402 FNL,24.402 FNLL F18 F19	05.94 - 05.95	D2866LF06, D2866LF05, D2865LF04,	 3400 700 327 ⊗ 3482 114 031 ⊗ 1878 004 832 ⊙ 3151 263 031	430 10 GMFZ430N 430WGTZ KZISZ-6	für Fahrzeuge mit Nebenantrieb / for vehicles with PTO Nebenantriebs-ID / PTO ID: NMV-221	(73) (48)	
26.342 DF,26.342 DFL F08 F16	05.94 - 06.96	D2865LF05, D2865LF09, D2866LF09					
26.342 DFK,26.342 DFLK F08 F16	05.94 - 06.96						
26.342 DFS F08	04.94 - 06.96						
26.402 DF,26.402 DFL F08 F16	05.94 - 06.96						
26.402 DFK,26.402 DFLK F16 F08	05.94 - 06.96						
26.402 DFS F08	05.94 - 12.95						
26.402 FNL,26.402 FNLL,26.402 FVL F07 F18 F19	05.94 - 06.96						
26.402 FNLS,26.402 FVLS F07 F18	05.94 - 06.96						
32.292 VF F13	03.88 - 02.90						
32.292 VFK F13	03.88 - 02.90						
32.342 VFK F13	05.94 - 06.96						
32.372 VF F13	02.90 - 06.96						
32.372 VFK F13	05.90 - 04.95						
32.402 VFK F13	05.94 - 06.96						
33.272 DF F09	10.92 - 04.95						
33.272 DFA F10	10.92 - 04.95						
33.272 FVL F07	10.92 - 04.95						
33.322 DF F09	09.91 - 06.96						
33.322 FVL F07	09.91 - 06.96						
33.342 DF F09	05.94 - 06.96						
33.342 DFA F10	05.94 - 06.96						
33.372 DFK F09	01.91 - 06.96						
33.372 DFS F09	09.91 - 06.96						
33.402 DF F09	05.94 - 06.96						
33.402 DFA F10	05.94 - 06.96						
33.402 DFAK F10	05.94 - 06.96						
33.402 DFS F09	05.94 - 06.96						
33.402 DFK F09	05.94 - 06.96						





















		CODE				
--	--	------	--	---	---	---

MAN

F 90		06.86 - 12.97					
33.422 DF F09	09.91 - 06.96	D2866LF/290, D2866LF03, D2866LFZ/330,	 3400 127 601 ⊗ 3482 078 133 ⊗ 1862 364 031 ⊙ 3151 000 034	400 10 MFZ400 400WGVZ KZISZ-5	Nabenprofil / Hub Profile: 2"-10N Je nach Kundenwunsch mit unterschiedlicher Kupplung / Equipped with different clutch according to customer requirement	(46) (33)	
33.422 DFS F09	01.94 - 06.96	D2866LF03, D2866LFZ/330,	 3400 122 201 ⊗ 3482 083 032 ⊗ 1878 004 832 ⊙ 3151 000 034	430 10 MFZ430 430WGTZ KZISZ-5	Je nach Kundenwunsch mit unterschiedlicher Kupplung / Equipped with different clutch according to customer requirement	(33)	
33.422 DFK F09	01.94 - 06.96	D2866LF06, D2866LF05, D2866LF16, D2866LXF, D2866LF15, D2866LF06, D2866LF05, D2866LF04, D2866LF05, D2866LF09, D2866LF09	 3400 121 901 ⊗ 3488 017 333 ⊗ 1862 303 031 ⊙ 3151 000 034	400 10 MFZ2/400X 400WGVZ KZISZ-5	für Fahrzeuge mit Zweischeibenkupplung / for vehicles with double disc clutch	(77)	
35.332 VF F14	10.88 - 04.95	D2866LF15, D2866LF06, D2866LF05, D2866LF04, D2866LF05, D2866LF09, D2866LF09	 3400 700 327 ⊗ 3482 114 031 ⊗ 1878 004 832 ⊙ 3151 263 031	430 10 GMFZ430N 430WGTZ KZISZ-6	für Fahrzeuge mit Nebenantrieb / for vehicles with PTO Nebenantriebs-ID / PTO ID: NMV-221	(73) (48)	
35.332 VFK F14	10.88 - 04.95	D2866LF05, D2866LF04, D2866LF05, D2866LF09, D2866LF09					
35.302 VFA E15	05.90 - 09.91	D2866LF09, D2866LF09					
35.302 VFAK E15	05.90 - 09.91	D2866LF09, D2866LF09					
35.362 VF F14	10.88 - 02.90						
35.362 VFK F14	10.88 - 02.90						
35.372 VF F14	02.90 - 04.95						
35.372 VFK F14	02.90 - 04.95						
25.502 DF F28	09.90 - 12.92	D2840LF01, 04	 3400 122 201 ⊗ 3482 083 032 ⊗ 1878 004 832 ⊙ 3151 000 034	430 10 MFZ430 430WGTZ KZISZ-5	F25,28,36 Je nach Kundenwunsch mit unterschiedlicher Kupplung / Equipped with different clutch according to customer requirement	(33)	
25.502 DFS F28	09.90 - 12.92						
25.502 FNL F25	09.90 - 12.92		 3400 121 901 ⊗ 3488 017 333 ⊗ 1862 303 031 ⊙ 3151 000 034	400 10 MFZ2/400X 400WGVZ KZISZ-5	F25,28,36 für Fahrzeuge mit Zweischeibenkupplung / for vehicles with double disc clutch	(77)	
24.502 DF F28	02.90 - 12.90				Je nach Kundenwunsch mit unterschiedlicher Kupplung / Equipped with different clutch according to customer requirement	(33)	
24.502 DFK F28	02.90 - 12.90						
24.502 DFS F28	02.90 - 12.90						
24.502 FNL F25	02.90 - 12.90						
26.242	07.90 -	D2866	 1882 017 131	420 GF420XN	Nebenantriebs-ID / PTO ID: 130E	(48)	
26.332	07.90 -						
26.362	07.90 -		 1878 086 941	420 10 420WGTZ	Nebenantriebs-ID / PTO ID: 130E	(48)	
26.242 DF F09	01.88 - 07.89	D2866F	 3400 127 601 ⊗ 3482 078 133 ⊗ 1862 364 031 ⊙ 3151 000 034	400 10 MFZ400 400WGVZ KZISZ-5	F05-10,16 Nabenprofil / Hub Profile: 2"-10N Je nach Kundenwunsch mit unterschiedlicher Kupplung / Equipped with different clutch according to customer requirement	(46) (33)	
26.242 DFK F09	01.88 - 07.89						
26.242 DFS F09	01.88 - 07.89		 3400 700 310 ⊗ 3482 078 133 ⊗ 1862 364 133 ⊙ 3151 000 034	400 10 MFZ400 400WGVZ KZISZ-5	F05-10,16 Nabenprofil / Hub Profile: 1 3/4"-10N	(46)	
			 3400 121 901 ⊗ 3488 017 333 ⊗ 1862 303 031 ⊙ 3151 000 034	400 10 MFZ2/400X 400WGVZ KZISZ-5	F05-10,16 für Fahrzeuge mit Zweischeibenkupplung / for vehicles with double disc clutch Je nach Kundenwunsch mit unterschiedlicher Kupplung / Equipped with different clutch according to customer requirement	(77) (33)	
		D2866F/240	 3483 023 003 ⊕	445 GMFZ445W	für Fahrzeuge mit Wandlerschaltkupplung / for vehicles with converter and clutch unit	(76)	
			 1878 051 801	445 24 445GTZC	für Fahrzeuge mit Wandlerschaltkupplung / for vehicles with converter and clutch unit	(76)	



















		CODE				
--	--	------	--	---	---	---

MAN

F 90		06.86 - 12.97						
26.242 DFAK F10	02.89 - 07.89	D2866F	 3400 127 601 ⊗ 3482 078 133 ⊗ 1862 364 031 ⊙ 3151 000 034	400 10 MFZ400 400WGVZ KZISZ-5	F05-10,16 Nabenprofil / Hub Profile: 2"-10N Je nach Kundenwunsch mit unterschiedlicher Kupplung / Equipped with different clutch according to customer requirement	(46)	(33)	
			 3400 700 310 ⊗ 3482 078 133 ⊗ 1862 364 133 ⊙ 3151 000 034	400 10 MFZ400 400WGVZ KZISZ-5	F05-10,16 Nabenprofil / Hub Profile: 1 3/4"-10N	(46)		
			 3400 121 901 ⊗ 3488 017 333 ⊗ 1862 303 031 ⊙ 3151 000 034	400 10 MFZ2/400X 400WGVZ KZISZ-5	F05-10,16 für Fahrzeuge mit Zweischeibenkupplung / for vehicles with double disc clutch Je nach Kundenwunsch mit unterschiedlicher Kupplung / Equipped with different clutch according to customer requirement	(77)	(33)	
	D2866F/240	 3483 023 001 ⊕	445 GMFZ445W	für Fahrzeuge mit Wandlerschaltkupplung / for vehicles with converter and clutch unit	(76)			
		 1878 051 801	445 24 445GTZC	für Fahrzeuge mit Wandlerschaltkupplung / for vehicles with converter and clutch unit	(76)			
24.422 DF F08 24.422 DFK F08 24.422 DFS, 24.422 DFLS F16 F08 24.422 FNL, 24.422 FNLL, 24.422 FVL F07 F19 F18 F05 F06	02.90 - 12.90	D2866LF06, 09	 3400 122 201 ⊗ 3482 083 032 ⊗ 1878 004 832 ⊙ 3151 000 034	430 10 MFZ430 430WGTZ KZISZ-5	F05,06,07,08,16 Je nach Kundenwunsch mit unterschiedlicher Kupplung / Equipped with different clutch according to customer requirement	(33)		
	02.90 - 12.90		 3400 121 901 ⊗ 3488 017 333 ⊗ 1862 303 031 ⊙ 3151 000 034	400 10 MFZ2/400X 400WGVZ KZISZ-5	F05,06,07,08,16 für Fahrzeuge mit Zweischeibenkupplung / for vehicles with double disc clutch Je nach Kundenwunsch mit unterschiedlicher Kupplung / Equipped with different clutch according to customer requirement	(77)	(33)	
	02.90 - 12.90	D2866	 1882 017 131	420 GF420XN	07.1990-> für Nebenantrieb / for PTO	(82)		
	02.90 - 05.95		 1878 086 941	420 10 420WGTZ	07.1990-> für Nebenantrieb / for PTO	(82)		
			 3151 204 001	KZI-6	07.1990-> für Nebenantrieb / for PTO mit Schmierrohranschluß / with lubricating pipe coupling	(82)	(91)	
	26.256 26.280		D2566MF	 1861 526 046	420 10 420GSZ	Nebenantriebs-ID / PTO ID: 110	(48)	
	24.462 DF F28 24.462 DFS F28 24.462 FNL F25	02.89 - 02.90	D2840LF460	 3400 122 201 ⊗ 3482 083 032 ⊗ 1878 004 832 ⊙ 3151 000 034	430 10 MFZ430 430WGTZ KZISZ-5	F25,28 Je nach Kundenwunsch mit unterschiedlicher Kupplung / Equipped with different clutch according to customer requirement	(33)	
04.89 - 02.90		 3400 121 901 ⊗ 3488 017 333 ⊗ 1862 303 031 ⊙ 3151 000 034		400 10 MFZ2/400X 400WGVZ KZISZ-5	F25,28 für Fahrzeuge mit Zweischeibenkupplung / for vehicles with double disc clutch Je nach Kundenwunsch mit unterschiedlicher Kupplung / Equipped with different clutch according to customer requirement	(77)	(33)	
26.262 DF F09 26.262 DFK F09 26.262 DFS F09	01.88 - 02.90	D2865LF	 3400 127 601 ⊗ 3482 078 133 ⊗ 1862 364 031 ⊙ 3151 000 034	400 10 MFZ400 400WGVZ KZISZ-5	F05-10,16 Nabenprofil / Hub Profile: 2"-10N Je nach Kundenwunsch mit unterschiedlicher Kupplung / Equipped with different clutch according to customer requirement	(46)	(33)	
	01.88 - 02.90		 3400 700 310 ⊗ 3482 078 133 ⊗ 1862 364 133 ⊙ 3151 000 034	400 10 MFZ400 400WGVZ KZISZ-5	F05-10,16 Nabenprofil / Hub Profile: 1 3/4"-10N	(46)		
	01.88 - 02.90		 3400 121 901 ⊗ 3488 017 333 ⊗ 1862 303 031 ⊙ 3151 000 034	400 10 MFZ2/400X 400WGVZ KZISZ-5	F05-10,16 für Fahrzeuge mit Zweischeibenkupplung / for vehicles with double disc clutch Je nach Kundenwunsch mit unterschiedlicher Kupplung / Equipped with different clutch according to customer requirement	(77)	(33)	
	D2865	 1882 017 131	420 GF420XN	F05-10,16 Nebenantriebs-ID / PTO ID: 130E	(48)			
		 1878 086 941	420 10 420WGTZ	F05-10,16 Nebenantriebs-ID / PTO ID: 130E	(48)			
		 3151 204 001	KZI-6	F05-10,16 mit Schmierrohranschluß / with lubricating pipe coupling Nebenantriebs-ID / PTO ID: 130E	(91)	(48)		
	D2865LF/260	 3483 023 003 ⊕	445 GMFZ445W	für Fahrzeuge mit Wandlerschaltkupplung / for vehicles with converter and clutch unit	(76)			
		 1878 051 801	445 24 445GTZC	für Fahrzeuge mit Wandlerschaltkupplung / for vehicles with converter and clutch unit	(76)			



















		CODE				
--	--	------	--	---	---	---

MAN

F 90		06.86 - 12.97					
24.462 FVLS F07	05.87 - 07.87	D2865LF01, 02, 04, 05	 3400 127 601 ⊗ 3482 078 133 ⊗ 1862 364 031 ⊙ 3151 000 034	400 10 MFZ400 400WGVZ KZISZ-5	F05,06,07,08,16 Nabenprofil / Hub Profile: 2"-10N Je nach Kundenwunsch mit unterschiedlicher Kupplung / Equipped with different clutch according to customer requirement	(46) (33)	
			 3400 700 301 #⊕ ⊗ 3483 022 031 ⊗ 1862 349 031	400 10 MFZ400X 400GVZ	F05,06,07,08,16		
			 3400 121 901 ⊗ 3488 017 333 ⊗ 1862 303 031 ⊙ 3151 000 034	400 10 MFZ2/400X 400WGVZ KZISZ-5	F05,06,07,08,16 für Fahrzeuge mit Zweischeibenkupplung / for vehicles with double disc clutch Je nach Kundenwunsch mit unterschiedlicher Kupplung / Equipped with different clutch according to customer requirement	(77) (33)	
26.262 DFA F10 26.262 DFAS F10 26.262 DFAK F10	02.89 - 02.90	D2865LF	 3400 127 601 ⊗ 3482 078 133 ⊗ 1862 364 031 ⊙ 3151 000 034	400 10 MFZ400 400WGVZ KZISZ-5	F05-10,16 Nabenprofil / Hub Profile: 2"-10N Je nach Kundenwunsch mit unterschiedlicher Kupplung / Equipped with different clutch according to customer requirement	(46) (33)	
			 3400 700 310 ⊗ 3482 078 133 ⊗ 1862 364 133 ⊙ 3151 000 034	400 10 MFZ400 400WGVZ KZISZ-5	F05-10,16 Nabenprofil / Hub Profile: 1 3/4"-10N	(46)	
			 3400 121 901 ⊗ 3488 017 333 ⊗ 1862 303 031 ⊙ 3151 000 034	400 10 MFZ2/400X 400WGVZ KZISZ-5	F05-10,16 für Fahrzeuge mit Zweischeibenkupplung / for vehicles with double disc clutch Je nach Kundenwunsch mit unterschiedlicher Kupplung / Equipped with different clutch according to customer requirement	(77) (33)	
	02.89 - 02.90	D2865	 1882 017 131	420 GF420XN	F05-10,16 Nebenantriebs-ID / PTO ID: 130E	(48)	
			 1878 086 941	420 10 420WGTZ	F05-10,16 Nebenantriebs-ID / PTO ID: 130E	(48)	
			 3151 204 001	KZI-6	F05-10,16 mit Schmierrohranschluß / with lubricating pipe coupling Nebenantriebs-ID / PTO ID: 130E	(91) (48)	
	02.89 - 02.90	D2865LF/260	 3483 023 001 ⊕	445 GMFZ445W	für Fahrzeuge mit Wandlerschaltkupplung / for vehicles with converter and clutch unit	(76)	
			 1878 051 801	445 24 445GTZC	für Fahrzeuge mit Wandlerschaltkupplung / for vehicles with converter and clutch unit	(76)	
	26.272 DF F09 F08 26.272 DFK F09 F08 26.272 DFS,26.272 DFLS F09 F08 F16	02.90 - 06.96	D2865LF01, 02, 04, 05	 3400 121 901 ⊗ 3488 017 333 ⊗ 1862 303 031 ⊙ 3151 000 034	400 10 MFZ2/400X 400WGVZ KZISZ-5	F05-10,16,18 für Fahrzeuge mit Zweischeibenkupplung / for vehicles with double disc clutch Je nach Kundenwunsch mit unterschiedlicher Kupplung / Equipped with different clutch according to customer requirement	(77) (33)
 3400 127 601 ⊗ 3482 078 133 ⊗ 1862 364 031 ⊙ 3151 000 034				400 10 MFZ400 400WGVZ KZISZ-5	F05-10,16,18,19 Nabenprofil / Hub Profile: 2"-10N Je nach Kundenwunsch mit unterschiedlicher Kupplung / Equipped with different clutch according to customer requirement	(46) (33)	
 3400 700 310 ⊗ 3482 078 133 ⊗ 1862 364 133 ⊙ 3151 000 034				400 10 MFZ400 400WGVZ KZISZ-5	F05-10,16,18,19 Nabenprofil / Hub Profile: 1 3/4"-10N	(46)	
02.90 - 06.96		D2865	 1882 017 131	420 GF420XN	für Nebenantrieb / for PTO	(82)	
			 1878 086 941	420 10 420WGTZ	für Nebenantrieb / for PTO	(82)	
			 3151 204 001	KZI-6	für Nebenantrieb / for PTO mit Schmierrohranschluß / with lubricating pipe coupling	(82) (91)	
02.90 - 06.96		D2865LF02, D2865LF05	 3483 023 003 ⊕	445 GMFZ445W	F09 für Fahrzeuge mit Wandlerschaltkupplung / for vehicles with converter and clutch unit	(76)	
			 1878 051 801	445 24 445GTZC	F09 für Fahrzeuge mit Wandlerschaltkupplung / for vehicles with converter and clutch unit	(76)	

















































		CODE				
--	--	------	--	---	---	---

MAN

F 90		06.86 - 12.97					
26.272 DFA F10 26.272 DFAK F10 26.272 DFAS F10	02.90 - 12.92	D2865LF01, 02, 04, 05	 3400 121 901 ⊗ 3488 017 333 ⊗ 1862 303 031 ⊙ 3151 000 034	400 10 MFZ2/400X 400WGVZ KZISZ-5	F05-10,16,18 für Fahrzeuge mit Zweischeibenkupplung / for vehicles with double disc clutch Je nach Kundenwunsch mit unterschiedlicher Kupplung / Equipped with different clutch according to customer requirement	(77)	
	02.90 - 12.92		 3400 127 601 ⊗ 3482 078 133 ⊗ 1862 364 031 ⊙ 3151 000 034	400 10 MFZ400 400WGVZ KZISZ-5	F05-10,16,18,19 Nabenprofil / Hub Profile: 2"-10N Je nach Kundenwunsch mit unterschiedlicher Kupplung / Equipped with different clutch according to customer requirement	(46) (33)	
	02.90 - 12.92		 3400 700 310 ⊗ 3482 078 133 ⊗ 1862 364 133 ⊙ 3151 000 034	400 10 MFZ400 400WGVZ KZISZ-5	F05-10,16,18,19 Nabenprofil / Hub Profile: 1 3/4"-10N	(46)	
		D2865	 1882 017 131	420 GF420XN	für Nebenantrieb / for PTO	(82)	
			 1878 086 941	420 10 420WGTZ	für Nebenantrieb / for PTO	(82)	
			 3151 204 001	KZI-6	für Nebenantrieb / for PTO mit Schmierrohranschluß / with lubricating pipe coupling	(82) (91)	
			D2865LF02, D2865LF05	 3483 023 001 ⊕	445 GMFZ445W	für Fahrzeuge mit Wandlerschaltkupplung / for vehicles with converter and clutch unit	(76)
				 1878 051 801	445 24 445GTZC	für Fahrzeuge mit Wandlerschaltkupplung / for vehicles with converter and clutch unit	(76)
	25.272 DF F08	09.90 - 12.92	D2865LF01, 02, 04, 05	 3400 127 601 ⊗ 3482 078 133 ⊗ 1862 364 031 ⊙ 3151 000 034	400 10 MFZ400 400WGVZ KZISZ-5	F05,06,07,08,16 Nabenprofil / Hub Profile: 2"-10N Je nach Kundenwunsch mit unterschiedlicher Kupplung / Equipped with different clutch according to customer requirement	(46) (33)
				 3400 700 310 ⊗ 3482 078 133 ⊗ 1862 364 133 ⊙ 3151 000 034	400 10 MFZ400 400WGVZ KZISZ-5	F05,06,07,08,16 Nabenprofil / Hub Profile: 1 3/4"-10N	(46)
 3400 121 901 ⊗ 3488 017 333 ⊗ 1862 303 031 ⊙ 3151 000 034				400 10 MFZ2/400X 400WGVZ KZISZ-5	F05,06,07,08,16 für Fahrzeuge mit Zweischeibenkupplung / for vehicles with double disc clutch Je nach Kundenwunsch mit unterschiedlicher Kupplung / Equipped with different clutch according to customer requirement	(77) (33)	
		D2865	 1882 017 131	420 GF420XN	für Nebenantrieb / for PTO	(82)	
			 1878 086 941	420 10 420WGTZ	für Nebenantrieb / for PTO	(82)	
			 3151 204 001	KZI-6	für Nebenantrieb / for PTO mit Schmierrohranschluß / with lubricating pipe coupling	(82) (91)	
25.272 DFK F08 25.272 DFS,25.272 DFSL F16 F08 25.272 FNL,25.272 FNLL,25.272 FVL F05 F07 F06		09.90 - 12.92	D2865LF01, 02, 04, 05	 3400 127 601 ⊗ 3482 078 133 ⊗ 1862 364 031 ⊙ 3151 000 034	400 10 MFZ400 400WGVZ KZISZ-5	F05,06,07,08,16 Nabenprofil / Hub Profile: 2"-10N Je nach Kundenwunsch mit unterschiedlicher Kupplung / Equipped with different clutch according to customer requirement	(46) (33)
	09.90 - 12.92	 3400 700 310 ⊗ 3482 078 133 ⊗ 1862 364 133 ⊙ 3151 000 034		400 10 MFZ400 400WGVZ KZISZ-5	F05,06,07,08,16 Nabenprofil / Hub Profile: 1 3/4"-10N	(46)	
	09.90 - 10.93	 3400 121 901 ⊗ 3488 017 333 ⊗ 1862 303 031 ⊙ 3151 000 034		400 10 MFZ2/400X 400WGVZ KZISZ-5	F05,06,07,08,16 für Fahrzeuge mit Zweischeibenkupplung / for vehicles with double disc clutch Je nach Kundenwunsch mit unterschiedlicher Kupplung / Equipped with different clutch according to customer requirement	(77) (33)	
		D2865	 1882 017 131	420 GF420XN	für Nebenantrieb / for PTO	(82)	
			 1878 086 941	420 10 420WGTZ	für Nebenantrieb / for PTO	(82)	





















		CODE				
--	--	------	--	---	---	---

MAN

F 90		06.86 - 12.97					
26.272 FNL, 26.272 FNLL F19 F18 26.272 FNLS, 26.272 FVLS F18 F07	03.91 - 05.95	D2865LF01, 02, 04, 05	 3400 121 901  3488 017 333  1862 303 031  3151 000 034	400 10 MFZ2/400X 400WGVZ KZISZ-5	F05-10,16,18 für Fahrzeuge mit Zweischeibenkupplung / for vehicles with double disc clutch Je nach Kundenwunsch mit unterschiedlicher Kupplung / Equipped with different clutch according to customer requirement	(77) (33)	
	09.90 - 12.95			 3400 127 601  3482 078 133  1862 364 031  3151 000 034	400 10 MFZ400 400WGVZ KZISZ-5	F05-10,16,18,19 Nabenprofil / Hub Profile: 2"-10N Je nach Kundenwunsch mit unterschiedlicher Kupplung / Equipped with different clutch according to customer requirement	(46) (33)
				 3400 700 310  3482 078 133  1862 364 133  3151 000 034	400 10 MFZ400 400WGVZ KZISZ-5	F05-10,16,18,19 Nabenprofil / Hub Profile: 1 3/4"-10N	(46)
			D2865	 1882 017 131	420 GF420XN	für Nebenantrieb / for PTO	(82)
				 1878 086 941	420 10 420WGTZ	für Nebenantrieb / for PTO	(82)
				 3151 204 001	KZI-6	für Nebenantrieb / for PTO mit Schmierrohranschluß / with lubricating pipe coupling	(82) (91)
	26.292 F19	01.90 -	D2866LF07	 3400 127 601  3482 078 133  1862 364 031  3151 000 034	400 10 MFZ400 400WGVZ KZISZ-5	Nabenprofil / Hub Profile: 2"-10N	(46)
D2866			 1882 017 131	420 GF420XN	Nebenantriebs-ID / PTO ID: 130E	(48)	
			 1878 086 941	420 10 420WGTZ	Nebenantriebs-ID / PTO ID: 130E	(48)	
			26.292 DF, 26.292 DFL F09 26.292 DFK F09 26.292 DFS F09	09.87 - 02.90	D2866LF07	 3400 127 601  3482 078 133  1862 364 031  3151 000 034	400 10 MFZ400 400WGVZ KZISZ-5
09.87 - 02.90		 3400 122 201  3482 083 032  1878 004 832  3151 000 034		430 10 MFZ430 430WGTZ KZISZ-5	F05-10,16 Je nach Kundenwunsch mit unterschiedlicher Kupplung / Equipped with different clutch according to customer requirement	(33)	
09.87 - 02.90		 3400 121 901  3488 017 333  1862 303 031  3151 000 034		400 10 MFZ2/400X 400WGVZ KZISZ-5	F05-10,16 für Fahrzeuge mit Zweischeibenkupplung / for vehicles with double disc clutch Je nach Kundenwunsch mit unterschiedlicher Kupplung / Equipped with different clutch according to customer requirement	(77) (33)	
		D2866LF/290		 3483 023 003 ⊕	445 GMFZ445W	für Fahrzeuge mit Wandlerschaltkupplung / for vehicles with converter and clutch unit	(76)
				 1878 051 801	445 24 445GTZC	für Fahrzeuge mit Wandlerschaltkupplung / for vehicles with converter and clutch unit	(76)
		D2866		 1882 017 131	420 GF420XN	Nebenantriebs-ID / PTO ID: 130E	(48)
				 1878 086 941	420 10 420WGTZ	Nebenantriebs-ID / PTO ID: 130E	(48)
25.302 DF F08 25.302 DFK F08 25.302 DFS, 25.302 DFLS F16 F08 25.302 FNL, 25.302 FNLL, 25.302 FVL F05 F06 25.302 FNLS, 25.302 FVLS F05 F07	09.90 - 12.91	D2866LF04	 3400 127 601  3482 078 133  1862 364 031  3151 000 034	400 10 MFZ400 400WGVZ KZISZ-5	F05,06,07,08,16 Nabenprofil / Hub Profile: 2"-10N Je nach Kundenwunsch mit unterschiedlicher Kupplung / Equipped with different clutch according to customer requirement	(46) (33)	
	09.90 - 12.91		 3400 121 901  3488 017 333  1862 303 031  3151 000 034	400 10 MFZ2/400X 400WGVZ KZISZ-5	F05,06,07,08,16 für Fahrzeuge mit Zweischeibenkupplung / for vehicles with double disc clutch Je nach Kundenwunsch mit unterschiedlicher Kupplung / Equipped with different clutch according to customer requirement	(77) (33)	
	09.90 - 12.91	D2866	 1882 017 131	420 GF420XN	für Nebenantrieb / for PTO	(82)	
				 1878 086 941	420 10 420WGTZ	für Nebenantrieb / for PTO	(82)
				 3151 204 001	KZI-6	für Nebenantrieb / for PTO mit Schmierrohranschluß / with lubricating pipe coupling	(82) (91)





















		CODE				
--	--	------	--	---	---	---

MAN

F 90		06.86 - 12.97					
26.292 DFA F10 26.292 DFAS F10	05.88 - 02.90	D2866LF07	 3400 127 601 ⊗ 3482 078 133 ⊗ 1862 364 031 ⊙ 3151 000 034	400 10 MFZ400 400WGVZ KZISZ-5	F05-10,16 Nabenprofil / Hub Profile: 2"-10N Je nach Kundenwunsch mit unterschiedlicher Kupplung / Equipped with different clutch according to customer requirement	(46) (33)	
	05.88 - 02.90	D2866LF/290	 3400 122 201 ⊗ 3482 083 032 ⊗ 1878 004 832 ⊙ 3151 000 034	430 10 MFZ430 430WGTZ KZISZ-5	F05-10,16 Je nach Kundenwunsch mit unterschiedlicher Kupplung / Equipped with different clutch according to customer requirement	(33)	
			 3400 121 901 ⊗ 3488 017 333 ⊗ 1862 303 031 ⊙ 3151 000 034	400 10 MFZ2/400X 400WGVZ KZISZ-5	F05-10,16 für Fahrzeuge mit Zweischeibenkupplung / for vehicles with double disc clutch Je nach Kundenwunsch mit unterschiedlicher Kupplung / Equipped with different clutch according to customer requirement	(77) (33)	
			 3483 023 001 ⊕	445 GMFZ445W	für Fahrzeuge mit Wandlerschaltkupplung / for vehicles with converter and clutch unit	(76)	
	D2866		 1878 051 801	445 24 445GTZC	für Fahrzeuge mit Wandlerschaltkupplung / for vehicles with converter and clutch unit	(76)	
			 1882 017 131	420 GF420XN	Nebenantriebs-ID / PTO ID: 130E	(48)	
	D2866		 1878 086 941	420 10 420WGTZ	Nebenantriebs-ID / PTO ID: 130E	(48)	
	26.292 DFAK F10	05.88 - 02.90	D2865LF01, 02, 04, 05	 3400 127 601 ⊗ 3482 078 133 ⊗ 1862 364 031 ⊙ 3151 000 034	400 10 MFZ400 400WGVZ KZISZ-5	F05,06,07,08,16 Nabenprofil / Hub Profile: 2"-10N Je nach Kundenwunsch mit unterschiedlicher Kupplung / Equipped with different clutch according to customer requirement	(46) (33)
 3400 700 310 ⊗ 3482 078 133 ⊗ 1862 364 133 ⊙ 3151 000 034				400 10 MFZ400 400WGVZ KZISZ-5	F05,06,07,08,16 Nabenprofil / Hub Profile: 1 3/4"-10N	(46)	
 3400 121 901 ⊗ 3488 017 333 ⊗ 1862 303 031 ⊙ 3151 000 034				400 10 MFZ2/400X 400WGVZ KZISZ-5	F05,06,07,08,16 für Fahrzeuge mit Zweischeibenkupplung / for vehicles with double disc clutch Je nach Kundenwunsch mit unterschiedlicher Kupplung / Equipped with different clutch according to customer requirement	(77) (33)	
D2866LF07			 3400 122 201 ⊗ 3482 083 032 ⊗ 1878 004 832 ⊙ 3151 000 034	430 10 MFZ430 430WGTZ KZISZ-5	F05-10,16 Je nach Kundenwunsch mit unterschiedlicher Kupplung / Equipped with different clutch according to customer requirement	(33)	
			 1882 017 131	420 GF420XN	für Nebenantrieb / for PTO	(82)	
D2865			 1878 086 941	420 10 420WGTZ	für Nebenantrieb / for PTO	(82)	
			 3151 204 001	KZI-6	für Nebenantrieb / for PTO mit Schmierrohranschluß / with lubricating pipe coupling	(82) (91)	
			 3483 023 001 ⊕	445 GMFZ445W	für Fahrzeuge mit Wandlerschaltkupplung / for vehicles with converter and clutch unit	(76)	
D2866LF/290			 1878 051 801	445 24 445GTZC	für Fahrzeuge mit Wandlerschaltkupplung / for vehicles with converter and clutch unit	(76)	
25.322 DF, 25.322 DFL F08 25.322 DFK F08 25.322 DFS, 25.322 DFLS F08 F16 25.322 FNL, 25.322 FNLL, 25.322 FVL F05 F06 25.322 FNLS, 25.322 FVLS F05 F07		09.90 - 12.92	D2865LF03, 06	 3400 127 601 ⊗ 3482 078 133 ⊗ 1862 364 031 ⊙ 3151 000 034	400 10 MFZ400 400WGVZ KZISZ-5	F05,06,07,08,16 Nabenprofil / Hub Profile: 2"-10N Je nach Kundenwunsch mit unterschiedlicher Kupplung / Equipped with different clutch according to customer requirement	(46) (33)
		09.90 - 12.92		 3400 121 901 ⊗ 3488 017 333 ⊗ 1862 303 031 ⊙ 3151 000 034	400 10 MFZ2/400X 400WGVZ KZISZ-5	F05,06,07,08,16 für Fahrzeuge mit Zweischeibenkupplung / for vehicles with double disc clutch Je nach Kundenwunsch mit unterschiedlicher Kupplung / Equipped with different clutch according to customer requirement	(77) (33)
	09.90 - 12.92	 1882 017 131		420 GF420XN	für Nebenantrieb / for PTO	(82)	
	09.90 - 12.92	D2865	 1878 086 941	420 10 420WGTZ	für Nebenantrieb / for PTO	(82)	
			 3151 204 001	KZI-6	für Nebenantrieb / for PTO mit Schmierrohranschluß / with lubricating pipe coupling	(82) (91)	

















































		CODE				
--	--	------	--	---	---	---

MAN

F 90		06.86 - 12.97					
26.302 DF F09 26.302 DFS F09	05.90 - 12.91	D2866LF04	 3400 127 601 ⊗ 3482 078 133 ⊗ 1862 364 031 ⊙ 3151 000 034	400 10 MFZ400 400WGVZ KZISZ-5	F05-10,16,18,19 Nabenprofil / Hub Profile: 2"-10N Je nach Kundenwunsch mit unterschiedlicher Kupplung / Equipped with different clutch according to customer requirement	(46) (33)	
	05.90 - 12.91		 3400 121 901 ⊗ 3488 017 333 ⊗ 1862 303 031 ⊙ 3151 000 034	400 10 MFZ2/400X 400WGVZ KZISZ-5	F05-10,16,18,19 für Fahrzeuge mit Zweischeibenkupplung / for vehicles with double disc clutch Je nach Kundenwunsch mit unterschiedlicher Kupplung / Equipped with different clutch according to customer requirement	(77) (33)	
			 3483 023 003 ⊕	445 GMFZ445W	für Fahrzeuge mit Wandlerschaltkupplung / for vehicles with converter and clutch unit	(76)	
			 1878 051 801	445 24 445GTZC	für Fahrzeuge mit Wandlerschaltkupplung / for vehicles with converter and clutch unit	(76)	
	05.90 - 12.91	D2865LF01, 02, 04, 05	 3400 700 310 ⊗ 3482 078 133 ⊗ 1862 364 133 ⊙ 3151 000 034	400 10 MFZ400 400WGVZ KZISZ-5	F05,06,07,08,16 Nabenprofil / Hub Profile: 1 3/4"-10N	(46)	
		D2866	 1882 017 131	420 GF420XN	für Nebenantrieb / for PTO	(82)	
			 1878 086 941	420 10 420WGTZ	für Nebenantrieb / for PTO	(82)	
	 3151 204 001		KZI-6	für Nebenantrieb / for PTO mit Schmierrohranschluß / with lubricating pipe coupling	(82) (91)		
	26.302 DFA F10 26.302 DFAK F10 26.302 DFAS F10	05.90 - 12.91	D2866LF04	 3400 127 601 ⊗ 3482 078 133 ⊗ 1862 364 031 ⊙ 3151 000 034	400 10 MFZ400 400WGVZ KZISZ-5	F05-10,16,18,19 Nabenprofil / Hub Profile: 2"-10N Je nach Kundenwunsch mit unterschiedlicher Kupplung / Equipped with different clutch according to customer requirement	(46) (33)
		05.90 - 12.91		 3400 121 901 ⊗ 3488 017 333 ⊗ 1862 303 031 ⊙ 3151 000 034	400 10 MFZ2/400X 400WGVZ KZISZ-5	F05-10,16,18,19 für Fahrzeuge mit Zweischeibenkupplung / for vehicles with double disc clutch Je nach Kundenwunsch mit unterschiedlicher Kupplung / Equipped with different clutch according to customer requirement	(77) (33)
 3483 023 001 ⊕				445 GMFZ445W	für Fahrzeuge mit Wandlerschaltkupplung / for vehicles with converter and clutch unit	(76)	
 1878 051 801				445 24 445GTZC	für Fahrzeuge mit Wandlerschaltkupplung / for vehicles with converter and clutch unit	(76)	
05.90 - 12.91		D2866	 1882 017 131	420 GF420XN	für Nebenantrieb / for PTO	(82)	
			 1878 086 941	420 10 420WGTZ	für Nebenantrieb / for PTO	(82)	
			 3400 127 601 ⊗ 3482 078 133 ⊗ 1862 364 031 ⊙ 3151 000 034	400 10 MFZ400 400WGVZ KZISZ-5	F05-10,16,18,19 Nabenprofil / Hub Profile: 2"-10N Je nach Kundenwunsch mit unterschiedlicher Kupplung / Equipped with different clutch according to customer requirement	(46) (33)	
05.90 - 12.91		D2866LF04	 3400 121 901 ⊗ 3488 017 333 ⊗ 1862 303 031 ⊙ 3151 000 034	400 10 MFZ2/400X 400WGVZ KZISZ-5	F05-10,16,18,19 für Fahrzeuge mit Zweischeibenkupplung / for vehicles with double disc clutch Je nach Kundenwunsch mit unterschiedlicher Kupplung / Equipped with different clutch according to customer requirement	(77) (33)	
			 3483 023 003 ⊕	445 GMFZ445W	für Fahrzeuge mit Wandlerschaltkupplung / for vehicles with converter and clutch unit	(76)	
			 1878 051 801	445 24 445GTZC	für Fahrzeuge mit Wandlerschaltkupplung / for vehicles with converter and clutch unit	(76)	
	D2866		 1882 017 131	420 GF420XN	für Nebenantrieb / for PTO	(82)	
			 1878 086 941	420 10 420WGTZ	für Nebenantrieb / for PTO	(82)	















		CODE				
--	--	------	--	---	---	---

MAN

F 90		06.86 - 12.97					
26.302 FNL, 26.302 FNLL, 26.302 FVL F19 F18 26.302 FNLS,26.302 FVLS F18 F07	03.91 - 12.91	D2866LF04	 3400 127 601  3482 078 133  1862 364 031  3151 000 034	400 10 MFZ400 400WGVZ KZISZ-5	F05-10,16,18,19 Nabenprofil / Hub Profile: 2"-10N Je nach Kundenwunsch mit unterschiedlicher Kupplung / Equipped with different clutch according to customer requirement	(46) (33)	
	09.90 - 12.91		 3400 121 901  3488 017 333  1862 303 031  3151 000 034	400 10 MFZ2/400X 400WGVZ KZISZ-5	F05-10,16,18,19 für Fahrzeuge mit Zweischeibenkupplung / for vehicles with double disc clutch Je nach Kundenwunsch mit unterschiedlicher Kupplung / Equipped with different clutch according to customer requirement	(77) (33)	
		D2866	 1882 017 131	420 GF420XN	für Nebenantrieb / for PTO	(82)	
			 1878 086 941	420 10 420WGTZ	für Nebenantrieb / for PTO	(82)	
25.372 DF F08 25.372 DFK F08 25.372 DFS,25.372 DFLS F08 F16 25.372 FNL, 25.372 FNLL, 25.372 FVL F06 F05 25.372 FNLS,25.372 FVLS F07 F05	09.90 - 12.92	D2866LF01, 03, 05	 3400 127 601  3482 078 133  1862 364 031  3151 000 034	400 10 MFZ400 400WGVZ KZISZ-5	F05,06,07,08,16 Nabenprofil / Hub Profile: 2"-10N Je nach Kundenwunsch mit unterschiedlicher Kupplung / Equipped with different clutch according to customer requirement	(46) (33)	
	09.90 - 12.92		 3400 122 201  3482 083 032  1878 004 832  3151 000 034	430 10 MFZ430 430WGTZ KZISZ-5	F05,06,07,08,16 Je nach Kundenwunsch mit unterschiedlicher Kupplung / Equipped with different clutch according to customer requirement	(33)	
	09.90 - 12.92		 3400 121 901  3488 017 333  1862 303 031  3151 000 034	400 10 MFZ2/400X 400WGVZ KZISZ-5	F05,06,07,08,16 für Fahrzeuge mit Zweischeibenkupplung / for vehicles with double disc clutch Je nach Kundenwunsch mit unterschiedlicher Kupplung / Equipped with different clutch according to customer requirement	(77) (33)	
	09.90 - 10.93		D2866	 1882 017 131	420 GF420XN	für Nebenantrieb / for PTO	(82)
			 1878 086 941	420 10 420WGTZ	für Nebenantrieb / for PTO	(82)	
			 3151 204 001	KZI-6	für Nebenantrieb / for PTO mit Schmierrohranschluß / with lubricating pipe coupling	(82) (91)	
26.322 DF F09 F08 26.322 DFS,26.322 DFLS F16 F09 F08	02.90 - 06.96	D2865LF03, 06	 3400 127 601  3482 078 133  1862 364 031  3151 000 034	400 10 MFZ400 400WGVZ KZISZ-5	F05-10,16,18,19 Nabenprofil / Hub Profile: 2"-10N Je nach Kundenwunsch mit unterschiedlicher Kupplung / Equipped with different clutch according to customer requirement	(46) (33)	
	02.90 - 06.96		 3400 121 901  3488 017 333  1862 303 031  3151 000 034	400 10 MFZ2/400X 400WGVZ KZISZ-5	F05-10,16,18,19 für Fahrzeuge mit Zweischeibenkupplung / for vehicles with double disc clutch Je nach Kundenwunsch mit unterschiedlicher Kupplung / Equipped with different clutch according to customer requirement	(77) (33)	
		D2865	 1882 017 131	420 GF420XN	07.1990-> für Nebenantrieb / for PTO	(82)	
			 1878 086 941	420 10 420WGTZ	07.1990-> für Nebenantrieb / for PTO	(82)	
		D2865LF03, D2865LF06	 3483 023 003 ⊕	445 GMFZ445W	F09 für Fahrzeuge mit Wandlerschaltkupplung / for vehicles with converter and clutch unit	(76)	
		 1878 051 801	445 24 445GTZC	F09 für Fahrzeuge mit Wandlerschaltkupplung / for vehicles with converter and clutch unit	(76)		
26.322 DFA F10 26.322 DFAK F10 26.322 DFAS F10	02.90 - 12.92	D2865LF03, 06	 3400 127 601  3482 078 133  1862 364 031  3151 000 034	400 10 MFZ400 400WGVZ KZISZ-5	F05-10,16,18,19 Nabenprofil / Hub Profile: 2"-10N Je nach Kundenwunsch mit unterschiedlicher Kupplung / Equipped with different clutch according to customer requirement	(46) (33)	
	02.90 - 12.92		 3400 121 901  3488 017 333  1862 303 031  3151 000 034	400 10 MFZ2/400X 400WGVZ KZISZ-5	F05-10,16,18,19 für Fahrzeuge mit Zweischeibenkupplung / for vehicles with double disc clutch Je nach Kundenwunsch mit unterschiedlicher Kupplung / Equipped with different clutch according to customer requirement	(77) (33)	
	02.90 - 12.92	D2865	 1882 017 131	420 GF420XN	07.1990-> für Nebenantrieb / for PTO	(82)	
			 1878 086 941	420 10 420WGTZ	07.1990-> für Nebenantrieb / for PTO	(82)	
		D2865LF03, D2865LF06	 3483 023 001 ⊕	445 GMFZ445W	für Fahrzeuge mit Wandlerschaltkupplung / for vehicles with converter and clutch unit	(76)	
			 1878 051 801	445 24	für Fahrzeuge mit Wandlerschaltkupplung / for	(76)	

















		CODE				
--	--	------	--	---	---	---























MAN

F 90		06.86 - 12.97					
26.322 DFK F08 F09 26.322 FNL,26.322 FNLL F19 F18 26.322 FNLS,26.322 FVLS F07 F18	02.92 - 06.96	D2865LF03, 06	 3400 127 601 ⊗ 3482 078 133 ⊗ 1862 364 031 ⊙ 3151 000 034	400 10 MFZ400 400WGVZ KZISZ-5	F05-10,16,18,19 Nabenprofil / Hub Profile: 2"-10N Je nach Kundenwunsch mit unterschiedlicher Kupplung / Equipped with different clutch according to customer requirement	(46) (33)	
	03.91 - 05.95		 3400 121 901 ⊗ 3488 017 333 ⊗ 1862 303 031 ⊙ 3151 000 034	400 10 MFZ2/400X 400WGVZ KZISZ-5	F05-10,16,18,19 für Fahrzeuge mit Zweischeibenkupplung / for vehicles with double disc clutch Je nach Kundenwunsch mit unterschiedlicher Kupplung / Equipped with different clutch according to customer requirement	(77) (33)	
	09.90 - 12.95	D2865	 1882 017 131	420 GF420XN	für Nebenantrieb / for PTO	(82)	
			 1878 086 941	420 10 420WGTZ	für Nebenantrieb / for PTO	(82)	
25.422 DF F08 25.422 DFK F08 25.422 DFS,25.422 DFLS F16 F08 25.422 FNL,25.422 FNLL F06 F05 25.422 FNLS,25.422 FVLS F07 F05	09.90 - 12.92	D2866LF06, 09	 3400 122 201 ⊗ 3482 083 032 ⊗ 1878 004 832 ⊙ 3151 000 034	430 10 MFZ430 430WGTZ KZISZ-5	F05,06,07,08,16 Je nach Kundenwunsch mit unterschiedlicher Kupplung / Equipped with different clutch according to customer requirement	(33)	
	09.90 - 12.92		 3400 121 901 ⊗ 3488 017 333 ⊗ 1862 303 031 ⊙ 3151 000 034	400 10 MFZ2/400X 400WGVZ KZISZ-5	F05,06,07,08,16 für Fahrzeuge mit Zweischeibenkupplung / for vehicles with double disc clutch Je nach Kundenwunsch mit unterschiedlicher Kupplung / Equipped with different clutch according to customer requirement	(77) (33)	
	09.90 - 12.92	D2866	 1882 017 131	420 GF420XN	für Nebenantrieb / for PTO	(82)	
	09.90 - 12.92		 1878 086 941	420 10 420WGTZ	für Nebenantrieb / for PTO	(82)	
			 3151 204 001	KZI-6	für Nebenantrieb / for PTO mit Schmierrohranschluß / with lubricating pipe coupling	(82) (91)	
26.332 F19 38.302 F17 48.292 VF F15 48.292 VFA F15 48.292 VFAK F15	01.91 -	D2866LF/290, D2866LF08	 3400 127 601 ⊗ 3482 078 133 ⊗ 1862 364 031 ⊙ 3151 000 034	400 10 MFZ400 400WGVZ KZISZ-5	Nabenprofil / Hub Profile: 2"-10N	(46)	
	01.89 -						
	07.89 - 02.90						
	07.89 - 02.90						
26.332 DF, 26.332 DFL F09 26.332 DFK F09 26.332 DFS F09	09.87 - 02.90	D2866LF08	 3400 127 601 ⊗ 3482 078 133 ⊗ 1862 364 031 ⊙ 3151 000 034	400 10 MFZ400 400WGVZ KZISZ-5	F05-10,16 Nabenprofil / Hub Profile: 2"-10N Je nach Kundenwunsch mit unterschiedlicher Kupplung / Equipped with different clutch according to customer requirement	(46) (33)	
	09.87 - 02.90		 3400 122 201 ⊗ 3482 083 032 ⊗ 1878 004 832 ⊙ 3151 000 034	430 10 MFZ430 430WGTZ KZISZ-5	F05-10,16 Je nach Kundenwunsch mit unterschiedlicher Kupplung / Equipped with different clutch according to customer requirement	(33)	
	09.87 - 02.90		 3400 121 901 ⊗ 3488 017 333 ⊗ 1862 303 031 ⊙ 3151 000 034	400 10 MFZ2/400X 400WGVZ KZISZ-5	F05-10,16 für Fahrzeuge mit Zweischeibenkupplung / for vehicles with double disc clutch Je nach Kundenwunsch mit unterschiedlicher Kupplung / Equipped with different clutch according to customer requirement	(77) (33)	
		D2866LF/330	 3483 023 003 ⊕	445 GMFZ445W	für Fahrzeuge mit Wandlerschaltkupplung / for vehicles with converter and clutch unit	(76)	
			 1878 051 801	445 24 445GTZC	für Fahrzeuge mit Wandlerschaltkupplung / for vehicles with converter and clutch unit	(76)	

		CODE				
--	--	------	--	---	---	---







































MAN





















F 90		06.86 - 12.97					
26.332 DFA F10 26.332 DFAK F10 26.332 DFAS F10	05.88 - 02.90	D2866LF08	 3400 127 601 ⊗ 3482 078 133 ⊗ 1862 364 031 ⊙ 3151 000 034	400 10 MFZ400 400WGVZ KZISZ-5	F05-10,16 Nabenprofil / Hub Profile: 2"-10N Je nach Kundenwunsch mit unterschiedlicher Kupplung / Equipped with different clutch according to customer requirement	(46) (33)	
	05.88 - 02.90		 3400 122 201 ⊗ 3482 083 032 ⊗ 1878 004 832 ⊙ 3151 000 034	430 10 MFZ430 430WGTZ KZISZ-5	F05-10,16 Je nach Kundenwunsch mit unterschiedlicher Kupplung / Equipped with different clutch according to customer requirement	(33)	
	05.88 - 02.90		 3400 121 901 ⊗ 3488 017 333 ⊗ 1862 303 031 ⊙ 3151 000 034	400 10 MFZ2/400X 400WGVZ KZISZ-5	F05-10,16 für Fahrzeuge mit Zweischeibenkupplung / for vehicles with double disc clutch Je nach Kundenwunsch mit unterschiedlicher Kupplung / Equipped with different clutch according to customer requirement	(77) (33)	
			D2866LF/330	 3483 023 001 ⊕	445 GMFZ445W	für Fahrzeuge mit Wandlerschaltkupplung / for vehicles with converter and clutch unit	(76)
			 1878 051 801	445 24 445GTZC	für Fahrzeuge mit Wandlerschaltkupplung / for vehicles with converter and clutch unit	(76)	
26.362 DF, 26.362 DFL F09 F16	09.87 - 02.90	D2866KF, KU, LXF	 3400 122 201 ⊗ 3482 083 032 ⊗ 1878 004 832 ⊙ 3151 000 034	430 10 MFZ430 430WGTZ KZISZ-5	F05-10,16 Je nach Kundenwunsch mit unterschiedlicher Kupplung / Equipped with different clutch according to customer requirement	(33)	
			 3400 121 901 ⊗ 3488 017 333 ⊗ 1862 303 031 ⊙ 3151 000 034	400 10 MFZ2/400X 400WGVZ KZISZ-5	F05-10,16 für Fahrzeuge mit Zweischeibenkupplung / for vehicles with double disc clutch Je nach Kundenwunsch mit unterschiedlicher Kupplung / Equipped with different clutch according to customer requirement	(77) (33)	
		D2866KF, D2866LXF	 3483 023 003 ⊕	445 GMFZ445W	F09 für Fahrzeuge mit Wandlerschaltkupplung / for vehicles with converter and clutch unit	(76)	
				 1878 051 801	445 24 445GTZC	F09 für Fahrzeuge mit Wandlerschaltkupplung / for vehicles with converter and clutch unit	(76)
26.362 DFA F10 26.362 DFAK F10 26.362 DFAS F10	05.88 - 02.90	D2866KF, KU, LXF	 3400 122 201 ⊗ 3482 083 032 ⊗ 1878 004 832 ⊙ 3151 000 034	430 10 MFZ430 430WGTZ KZISZ-5	F05-10,16 Je nach Kundenwunsch mit unterschiedlicher Kupplung / Equipped with different clutch according to customer requirement	(33)	
	05.88 - 02.90		 3400 121 901 ⊗ 3488 017 333 ⊗ 1862 303 031 ⊙ 3151 000 034	400 10 MFZ2/400X 400WGVZ KZISZ-5	F05-10,16 für Fahrzeuge mit Zweischeibenkupplung / for vehicles with double disc clutch Je nach Kundenwunsch mit unterschiedlicher Kupplung / Equipped with different clutch according to customer requirement	(77) (33)	
	05.88 - 02.90		D2866LXF	 3483 023 001 ⊕	445 GMFZ445W	für Fahrzeuge mit Wandlerschaltkupplung / for vehicles with converter and clutch unit	(76)
				 1878 051 801	445 24 445GTZC	für Fahrzeuge mit Wandlerschaltkupplung / for vehicles with converter and clutch unit	(76)
26.362 DFK F09 26.362 DFS F09	09.87 - 02.90	D2866KF, KU, LXF	 3400 122 201 ⊗ 3482 083 032 ⊗ 1878 004 832 ⊙ 3151 000 034	430 10 MFZ430 430WGTZ KZISZ-5	F05-10,16 Je nach Kundenwunsch mit unterschiedlicher Kupplung / Equipped with different clutch according to customer requirement	(33)	
	09.87 - 02.90		 3400 121 901 ⊗ 3488 017 333 ⊗ 1862 303 031 ⊙ 3151 000 034	400 10 MFZ2/400X 400WGVZ KZISZ-5	F05-10,16 für Fahrzeuge mit Zweischeibenkupplung / for vehicles with double disc clutch Je nach Kundenwunsch mit unterschiedlicher Kupplung / Equipped with different clutch according to customer requirement	(77) (33)	
			D2866KF, D2866LXF	 3483 023 003 ⊕	445 GMFZ445W	für Fahrzeuge mit Wandlerschaltkupplung / for vehicles with converter and clutch unit	(76)
				 1878 051 801	445 24 445GTZC	für Fahrzeuge mit Wandlerschaltkupplung / for vehicles with converter and clutch unit	(76)

F 90		06.86 - 12.97						
26.372 DF,26.372 DFL F09 F16 F08 26.372 DFS F09 F08	02.90 - 06.96	D2866LF01, 03, 05	 3400 127 601 ● 3482 078 133 ● 1862 364 031 ○ 3151 000 034	400 10 MFZ400 400WGVZ KZISZ-5	F05-10,16,18,19 Nabenprofil / Hub Profile: 2"-10N Je nach Kundenwunsch mit unterschiedlicher Kupplung / Equipped with different clutch according to customer requirement	(46)	(33)	
	02.90 - 06.96		 3400 122 201 ● 3482 083 032 ● 1878 004 832 ○ 3151 000 034	430 10 MFZ430 430WGTZ KZISZ-5	F05-10,16,18,19 Je nach Kundenwunsch mit unterschiedlicher Kupplung / Equipped with different clutch according to customer requirement	(33)		
			 3400 121 901 ● 3488 017 333 ● 1862 303 031 ○ 3151 000 034	400 10 MFZ2/400X 400WGVZ KZISZ-5	F05-10,16,18,19 für Fahrzeuge mit Zweischeibenkupplung / for vehicles with double disc clutch Je nach Kundenwunsch mit unterschiedlicher Kupplung / Equipped with different clutch according to customer requirement	(77)	(33)	
		D2866	 1882 017 131	420 GF420XN	F05-10,16,18,19 Nebenantriebs-ID / PTO ID: 130E	(48)		
			 1878 086 941	420 10 420WGTZ	F05-10,16,18,19 Nebenantriebs-ID / PTO ID: 130E	(48)		
			 3151 204 001	KZI-6	F05-10,16,18,19 mit Schmierrohranschluß / with lubricating pipe coupling Nebenantriebs-ID / PTO ID: 130E	(91)	(48)	
			D2866LF03, D2866LF05, D2866LF15	 3483 023 003 ⊕	445 GMFZ445W	F09 für Fahrzeuge mit Wandlerschaltkupplung / for vehicles with converter and clutch unit	(76)	
				 1878 051 801	445 24 445GTZC	F09 für Fahrzeuge mit Wandlerschaltkupplung / for vehicles with converter and clutch unit	(76)	
	26.372 DFA F10 26.372 DFAK F10 26.372 DFAS F10	02.90 - 12.92	D2866LF01, 03, 05	 3400 127 601 ● 3482 078 133 ● 1862 364 031 ○ 3151 000 034	400 10 MFZ400 400WGVZ KZISZ-5	F05-10,16,18,19 Nabenprofil / Hub Profile: 2"-10N Je nach Kundenwunsch mit unterschiedlicher Kupplung / Equipped with different clutch according to customer requirement	(46)	(33)
		01.92 - 06.96		 3400 122 201 ● 3482 083 032 ● 1878 004 832 ○ 3151 000 034	430 10 MFZ430 430WGTZ KZISZ-5	F05-10,16,18,19 Je nach Kundenwunsch mit unterschiedlicher Kupplung / Equipped with different clutch according to customer requirement	(33)	
02.90 - 12.92			 3400 121 901 ● 3488 017 333 ● 1862 303 031 ○ 3151 000 034	400 10 MFZ2/400X 400WGVZ KZISZ-5	F05-10,16,18,19 für Fahrzeuge mit Zweischeibenkupplung / for vehicles with double disc clutch Je nach Kundenwunsch mit unterschiedlicher Kupplung / Equipped with different clutch according to customer requirement	(77)	(33)	
		D2866	 1882 017 131	420 GF420XN	F05-10,16,18,19 Nebenantriebs-ID / PTO ID: 130E	(48)		
			 1878 086 941	420 10 420WGTZ	F05-10,16,18,19 Nebenantriebs-ID / PTO ID: 130E	(48)		
			 3151 204 001	KZI-6	F05-10,16,18,19 mit Schmierrohranschluß / with lubricating pipe coupling Nebenantriebs-ID / PTO ID: 130E	(91)	(48)	
			D2866LF03, D2866LF05	 3483 023 001 ⊕	445 GMFZ445W	für Fahrzeuge mit Wandlerschaltkupplung / for vehicles with converter and clutch unit	(76)	
				 1878 051 801	445 24 445GTZC	für Fahrzeuge mit Wandlerschaltkupplung / for vehicles with converter and clutch unit	(76)	
26.372 DFK F08 26.372 FNL,26.372 FNLL,26.372 FVL F07 F19 F18 26.372 FNLS,26.372 FVLS F07 F18		01.92 - 06.96	D2866LF01, 03, 05	 3400 127 601 ● 3482 078 133 ● 1862 364 031 ○ 3151 000 034	400 10 MFZ400 400WGVZ KZISZ-5	F05-10,16,18,19 Nabenprofil / Hub Profile: 2"-10N Je nach Kundenwunsch mit unterschiedlicher Kupplung / Equipped with different clutch according to customer requirement	(46)	(33)
		09.90 - 12.95		 3400 122 201 ● 3482 083 032 ● 1878 004 832 ○ 3151 000 034	430 10 MFZ430 430WGTZ KZISZ-5	F05-10,16,18,19 Je nach Kundenwunsch mit unterschiedlicher Kupplung / Equipped with different clutch according to customer requirement	(33)	
	01.92 - 06.96		 3400 121 901 ● 3488 017 333 ● 1862 303 031 ○ 3151 000 034	400 10 MFZ2/400X 400WGVZ KZISZ-5	F05-10,16,18,19 für Fahrzeuge mit Zweischeibenkupplung / for vehicles with double disc clutch Je nach Kundenwunsch mit unterschiedlicher Kupplung / Equipped with different clutch according to customer requirement	(77)	(33)	
		D2866	 1882 017 131	420 GF420XN	F05-10,16,18,19 Nebenantriebs-ID / PTO ID: 130E	(48)		
			 1878 086 941	420 10 420WGTZ	F05-10,16,18,19 Nebenantriebs-ID / PTO ID: 130E	(48)		
			 3151 204 001	KZI-6	F05-10,16,18,19			

		CODE				
--	--	------	--	---	---	---





















MAN

F 90		06.86 - 12.97					
26.422 DF,26.422 DFL F09 F16 F08 26.422 DFK F09 F08 26.422 DFS F08 F09	02.90 - 06.96	D2866LF06, 09	 3400 122 201  3482 083 032  1878 004 832  3151 000 034	430 10 MFZ430 430WGTZ KZISZ-5	F05-10,16,18,19 Je nach Kundenwunsch mit unterschiedlicher Kupplung / Equipped with different clutch according to customer requirement	(33)	
	02.90 - 12.95		 3400 121 901  3488 017 333  1862 303 031  3151 000 034	400 10 MFZ2/400X 400WGVZ KZISZ-5	F05-10,16,18,19 für Fahrzeuge mit Zweischeibenkupplung / for vehicles with double disc clutch Je nach Kundenwunsch mit unterschiedlicher Kupplung / Equipped with different clutch according to customer requirement	(77) (33)	
	02.90 - 12.95	D2866	 1882 017 131	420 GF420XN	F05-10,16,18,19 Nebenantriebs-ID / PTO ID: 130E	(48)	
			 1878 086 941	420 10 420WGTZ	F05-10,16,18,19 Nebenantriebs-ID / PTO ID: 130E	(48)	
			 3151 204 001	KZI-6	F05-10,16,18,19 mit Schmierrohranschluß / with lubricating pipe coupling Nebenantriebs-ID / PTO ID: 130E	(91) (48)	
	02.90 - 12.95	D2866LF06, D2866LF09	 3483 023 003 	445 GMFZ445W	F09 für Fahrzeuge mit Wandlerschaltkupplung / for vehicles with converter and clutch unit	(76)	
			 1878 051 801	445 24 445GTZC	F09 für Fahrzeuge mit Wandlerschaltkupplung / for vehicles with converter and clutch unit	(76)	
	26.422 DFA F10 26.422 DFAK F10 26.422 DFAS F10	02.90 - 12.92	D2866LF06, 09	 3400 122 201  3482 083 032  1878 004 832  3151 000 034	430 10 MFZ430 430WGTZ KZISZ-5	F05-10,16,18,19 Je nach Kundenwunsch mit unterschiedlicher Kupplung / Equipped with different clutch according to customer requirement	(33)
		02.90 - 12.92		 3400 121 901  3488 017 333  1862 303 031  3151 000 034	400 10 MFZ2/400X 400WGVZ KZISZ-5	F05-10,16,18,19 für Fahrzeuge mit Zweischeibenkupplung / for vehicles with double disc clutch Je nach Kundenwunsch mit unterschiedlicher Kupplung / Equipped with different clutch according to customer requirement	(77) (33)
		02.90 - 12.92	D2866	 1882 017 131	420 GF420XN	F05-10,16,18,19 Nebenantriebs-ID / PTO ID: 130E	(48)
 1878 086 941				420 10 420WGTZ	F05-10,16,18,19 Nebenantriebs-ID / PTO ID: 130E	(48)	
 3151 204 001				KZI-6	F05-10,16,18,19 mit Schmierrohranschluß / with lubricating pipe coupling Nebenantriebs-ID / PTO ID: 130E	(91) (48)	
02.90 - 12.92		D2866LF06, D2866LF09	 3483 023 001 	445 GMFZ445W	für Fahrzeuge mit Wandlerschaltkupplung / for vehicles with converter and clutch unit	(76)	
			 1878 051 801	445 24 445GTZC	für Fahrzeuge mit Wandlerschaltkupplung / for vehicles with converter and clutch unit	(76)	
26.422 FNL,26.422 FNLL,26.422 FVL F07 F18 F19 26.422 FNLS,26.422 FVLS F07 F18		09.90 - 12.95	D2866LF06, 09	 3400 122 201  3482 083 032  1878 004 832  3151 000 034	430 10 MFZ430 430WGTZ KZISZ-5	F05-10,16,18,19 Je nach Kundenwunsch mit unterschiedlicher Kupplung / Equipped with different clutch according to customer requirement	(33)
		01.92 - 12.95	D2866	 3400 121 901  3488 017 333  1862 303 031  3151 000 034	400 10 MFZ2/400X 400WGVZ KZISZ-5	F05-10,16,18,19 für Fahrzeuge mit Zweischeibenkupplung / for vehicles with double disc clutch Je nach Kundenwunsch mit unterschiedlicher Kupplung / Equipped with different clutch according to customer requirement	(77) (33)
				 1882 017 131	420 GF420XN	F05-10,16,18,19 Nebenantriebs-ID / PTO ID: 130E	(48)
	 1878 086 941			420 10 420WGTZ	F05-10,16,18,19 Nebenantriebs-ID / PTO ID: 130E	(48)	
	01.92 - 12.95	D2866	 3151 204 001	KZI-6	F05-10,16,18,19 mit Schmierrohranschluß / with lubricating pipe coupling Nebenantriebs-ID / PTO ID: 130E	(91) (48)	

F 90		06.86 - 12.97					
26.462 DF F29 26.462 DFS F29	02.89 - 02.90	D2840LF	 3400 122 201 ⊗ 3482 083 032 ⊗ 1878 004 832 ⊙ 3151 000 034	430 10 MFZ430 430WGTZ KZISZ-5	F25,28,29 Je nach Kundenwunsch mit unterschiedlicher Kupplung / Equipped with different clutch according to customer requirement	(33)	
	02.89 - 02.90		 3400 121 901 ⊗ 3488 017 333 ⊗ 1862 303 031 ⊙ 3151 000 034	400 10 MFZ2/400X 400WGVZ KZISZ-5	F25,28,29 für Fahrzeuge mit Zweischeibenkupplung / for vehicles with double disc clutch Je nach Kundenwunsch mit unterschiedlicher Kupplung / Equipped with different clutch according to customer requirement	(77) (33)	
		D2840LF460	 3483 023 001 ⊕	445 GMFZ445W	für Fahrzeuge mit Wandlerschaltkupplung / for vehicles with converter and clutch unit	(76)	
			 1878 051 801	445 24 445GTZC	für Fahrzeuge mit Wandlerschaltkupplung / for vehicles with converter and clutch unit	(76)	
26.462 DFA F30 26.462 DFAS F30 26.502 DFA F30 26.502 DFAS F30	08.89 - 02.90	D2840LF04, D2840LF460, D2840LF01	 3483 023 001 ⊕	445 GMFZ445W	für Fahrzeuge mit Wandlerschaltkupplung / for vehicles with converter and clutch unit	(76)	
	08.89 - 02.90		 1878 051 801	445 24 445GTZC	für Fahrzeuge mit Wandlerschaltkupplung / for vehicles with converter and clutch unit	(76)	
	02.90 - 12.92						
26.502 DF F28 F29 26.502 DFS,26.502 DFSL F36 F28 F29	02.90 - 06.96	D2840LF01, 04	 3400 122 201 ⊗ 3482 083 032 ⊗ 1878 004 832 ⊙ 3151 000 034	430 10 MFZ430 430WGTZ KZISZ-5	F25,28,29,36 Je nach Kundenwunsch mit unterschiedlicher Kupplung / Equipped with different clutch according to customer requirement	(33)	
	02.90 - 06.96		 3400 121 901 ⊗ 3488 017 333 ⊗ 1862 303 031 ⊙ 3151 000 034	400 10 MFZ2/400X 400WGVZ KZISZ-5	F25,28,29,36 für Fahrzeuge mit Zweischeibenkupplung / for vehicles with double disc clutch Je nach Kundenwunsch mit unterschiedlicher Kupplung / Equipped with different clutch according to customer requirement	(77) (33)	
		D2840LF04, D2840LF01, D2840LF06	 3483 023 001 ⊕	445 GMFZ445W	für Fahrzeuge mit Wandlerschaltkupplung / for vehicles with converter and clutch unit	(76)	
			 1878 051 801	445 24 445GTZC	für Fahrzeuge mit Wandlerschaltkupplung / for vehicles with converter and clutch unit	(76)	
26.502 FNL,26.502 FNLL F25 F39	09.91 - 06.96	D2840LF01, 04	 3400 122 201 ⊗ 3482 083 032 ⊗ 1878 004 832 ⊙ 3151 000 034	430 10 MFZ430 430WGTZ KZISZ-5	F25,28,29,36 Je nach Kundenwunsch mit unterschiedlicher Kupplung / Equipped with different clutch according to customer requirement	(33)	
			 3400 121 901 ⊗ 3488 017 333 ⊗ 1862 303 031 ⊙ 3151 000 034	400 10 MFZ2/400X 400WGVZ KZISZ-5	F25,28,29,36 für Fahrzeuge mit Zweischeibenkupplung / for vehicles with double disc clutch Je nach Kundenwunsch mit unterschiedlicher Kupplung / Equipped with different clutch according to customer requirement	(77) (33)	
27.272 F05,06,07,08,09,10 28.272 F05-10,13,14 30.272 F13,14 31.272 F13,14	01.90 -	D2865LF01, 02, 04, 05	 3400 700 310 ⊗ 3482 078 133 ⊗ 1862 364 133 ⊙ 3151 000 034	400 10 MFZ400 400WGVZ KZISZ-5	Nabenprofil / Hub Profile: 1 3/4"-10N	(46)	
	01.90 -						
	01.90 -						
	01.90 -						
27.292 F10	01.86 - 12.92	D2866LF07	 3400 127 601 ⊗ 3482 078 133 ⊗ 1862 364 031 ⊙ 3151 000 034	400 10 MFZ400 400WGVZ KZISZ-5	Nabenprofil / Hub Profile: 2"-10N Je nach Kundenwunsch mit unterschiedlicher Kupplung / Equipped with different clutch according to customer requirement	(46) (33)	
			 3400 122 201 ⊗ 3482 083 032 ⊗ 1878 004 832 ⊙ 3151 000 034	430 10 MFZ430 430WGTZ KZISZ-5	Je nach Kundenwunsch mit unterschiedlicher Kupplung / Equipped with different clutch according to customer requirement	(33)	
			 3483 023 001 ⊕	445 GMFZ445W	für Fahrzeuge mit Wandlerschaltkupplung / for vehicles with converter and clutch unit	(76)	
			 1878 051 801	445 24 445GTZC	für Fahrzeuge mit Wandlerschaltkupplung / for vehicles with converter and clutch unit	(76)	
27.302 F10	01.90 - 12.92	D2866LF04	 3400 127 601 ⊗ 3482 078 133 ⊗ 1862 364 031 ⊙ 3151 000 034	400 10 MFZ400 400WGVZ KZISZ-5	Nabenprofil / Hub Profile: 2"-10N	(46)	
			 3483 023 001 ⊕	445 GMFZ445W	für Fahrzeuge mit Wandlerschaltkupplung / for vehicles with converter and clutch unit	(76)	
			 1878 051 801	445 24	für Fahrzeuge mit Wandlerschaltkupplung / for	(76)	

























		CODE				
--	--	------	--	---	---	---

MAN

F 90		06.86 - 12.97				
27.322 F09,10	01.90-	D2865LF03, 06	 3400 127 601 ⊗ 3482 078 133 ⊗ 1862 364 031 ⊙ 3151 000 034	400 10 MFZ400 400WGVZ KZISZ-5	Nabenprofil / Hub Profile: 2"-10N	(46)
			 1882 017 131	420 GF420XN	für Nebenantrieb / for PTO	(82)
			 1878 086 941	420 10 420WGTZ	für Nebenantrieb / for PTO	(82)
			 3151 204 001	KZI-6	für Nebenantrieb / for PTO mit Schmierrohranschluß / with lubricating pipe coupling	(82) (91)
27.332 F10	01.86 - 12.92	D2866LF08	 3400 127 601 ⊗ 3482 078 133 ⊗ 1862 364 031 ⊙ 3151 000 034	400 10 MFZ400 400WGVZ KZISZ-5	Nabenprofil / Hub Profile: 2"-10N Je nach Kundenwunsch mit unterschiedlicher Kupplung / Equipped with different clutch according to customer requirement	(46) (33)
			 3400 122 201 ⊗ 3482 083 032 ⊗ 1878 004 832 ⊙ 3151 000 034	430 10 MFZ430 430WGTZ KZISZ-5	Je nach Kundenwunsch mit unterschiedlicher Kupplung / Equipped with different clutch according to customer requirement	(33)
		 3483 023 001 ⊕	445 GMFZ445W	für Fahrzeuge mit Wandlerschaltkupplung / for vehicles with converter and clutch unit	(76)	
		 1878 051 801	445 24 445GTZC	für Fahrzeuge mit Wandlerschaltkupplung / for vehicles with converter and clutch unit	(76)	
27.362 F10	01.87 - 12.92	D2866KF	 3400 122 201 ⊗ 3482 083 032 ⊗ 1878 004 832 ⊙ 3151 000 034	430 10 MFZ430 430WGTZ KZISZ-5		
			 3483 023 001 ⊕	445 GMFZ445W	für Fahrzeuge mit Wandlerschaltkupplung / for vehicles with converter and clutch unit	(76)
		 1878 051 801	445 24 445GTZC	für Fahrzeuge mit Wandlerschaltkupplung / for vehicles with converter and clutch unit	(76)	
27.372 F09,10	01.90-	D2866LF01, 03, 05	 3400 127 601 ⊗ 3482 078 133 ⊗ 1862 364 031 ⊙ 3151 000 034	400 10 MFZ400 400WGVZ KZISZ-5	Nabenprofil / Hub Profile: 2"-10N Je nach Kundenwunsch mit unterschiedlicher Kupplung / Equipped with different clutch according to customer requirement	(46) (33)
			 3400 122 201 ⊗ 3482 083 032 ⊗ 1878 004 832 ⊙ 3151 000 034	430 10 MFZ430 430WGTZ KZISZ-5		
27.462 F30	01.89-	D2840LF	 3400 122 201 ⊗ 3482 083 032 ⊗ 1878 004 832 ⊙ 3151 000 034	430 10 MFZ430 430WGTZ KZISZ-5	Je nach Kundenwunsch mit unterschiedlicher Kupplung / Equipped with different clutch according to customer requirement	(33)
			 3400 121 901 ⊗ 3488 017 333 ⊗ 1862 303 031 ⊙ 3151 000 034	400 10 MFZ2/400X 400WGVZ KZISZ-5	für Fahrzeuge mit Zweischeibenkupplung / for vehicles with double disc clutch Je nach Kundenwunsch mit unterschiedlicher Kupplung / Equipped with different clutch according to customer requirement	(77) (33)
		 3483 023 001 ⊕	445 GMFZ445W	für Fahrzeuge mit Wandlerschaltkupplung / for vehicles with converter and clutch unit	(76)	
		 1878 051 801	445 24 445GTZC	für Fahrzeuge mit Wandlerschaltkupplung / for vehicles with converter and clutch unit	(76)	
27.502 F30	01.90-	D2840LF01, 07	 3400 122 201 ⊗ 3482 083 032 ⊗ 1878 004 832 ⊙ 3151 000 034	430 10 MFZ430 430WGTZ KZISZ-5	Je nach Kundenwunsch mit unterschiedlicher Kupplung / Equipped with different clutch according to customer requirement	(33)
			 3400 121 901 ⊗ 3488 017 333 ⊗ 1862 303 031 ⊙ 3151 000 034	400 10 MFZ2/400X 400WGVZ KZISZ-5	für Fahrzeuge mit Zweischeibenkupplung / for vehicles with double disc clutch Je nach Kundenwunsch mit unterschiedlicher Kupplung / Equipped with different clutch according to customer requirement	(77) (33)
		 3483 023 001 ⊕	445 GMFZ445W	für Fahrzeuge mit Wandlerschaltkupplung / for vehicles with converter and clutch unit	(76)	
		 1878 051 801	445 24 445GTZC	für Fahrzeuge mit Wandlerschaltkupplung / for vehicles with converter and clutch unit	(76)	





















		CODE					
--	--	------	--	--	---	---	---

MAN

F 90		06.86 - 12.97					
28.242 F09	01.87 - 12.92	D2866LF	 3400 700 310 ⊗ 3482 078 133 ⊗ 1862 364 133 ⊙ 3151 000 034	400 10 MFZ400 400WGVZ KZISZ-5	Nabenprofil / Hub Profile: 1 3/4"-10N	(46)	
			 1882 017 131	420 GF420XN	Nebenantriebs-ID / PTO ID: 130E	(48)	
			 1878 086 941	420 10 420WGTZ	Nebenantriebs-ID / PTO ID: 130E	(48)	
			 3483 023 003 ⊕	445 GMFZ445W	für Fahrzeuge mit Wandlerschaltkupplung / for vehicles with converter and clutch unit	(76)	
			 1878 051 801	445 24 445GTZC	für Fahrzeuge mit Wandlerschaltkupplung / for vehicles with converter and clutch unit	(76)	
28.262 F09,13,14	01.87 -	D2865LF	 3400 700 310 ⊗ 3482 078 133 ⊗ 1862 364 133 ⊙ 3151 000 034	400 10 MFZ400 400WGVZ KZISZ-5	Nabenprofil / Hub Profile: 1 3/4"-10N	(46)	
			 1882 017 131	420 GF420XN	Nebenantriebs-ID / PTO ID: 130E	(48)	
			 1878 086 941	420 10 420WGTZ	Nebenantriebs-ID / PTO ID: 130E	(48)	
28.322 F09,13,14 30.322 F13,14 31.322 F13,14	01.90 -	D2865LF03, 06	 3400 127 601 ⊗ 3482 078 133 ⊗ 1862 364 031 ⊙ 3151 000 034	400 10 MFZ400 400WGVZ KZISZ-5	Nabenprofil / Hub Profile: 2"-10N	(46)	
	01.90 -						
	01.90 -						
28.362 F09,13,14	01.87 -	D2866KF, LXF	 3400 122 201 ⊗ 3482 083 032 ⊗ 1878 004 832 ⊙ 3151 000 034	430 10 MFZ430 430WGTZ KZISZ-5			
			 1882 017 131	420 GF420XN	Nebenantriebs-ID / PTO ID: 130E	(48)	
			 1878 086 941	420 10 420WGTZ	Nebenantriebs-ID / PTO ID: 130E	(48)	
28.372 F09,13,14 30.372 F13,14 31.372 F13,14	01.90 -	D2866LF01, 03, 05	 3400 127 601 ⊗ 3482 078 133 ⊗ 1862 364 031 ⊙ 3151 000 034	400 10 MFZ400 400WGVZ KZISZ-5	Nabenprofil / Hub Profile: 2"-10N Je nach Kundenwunsch mit unterschiedlicher Kupplung / Equipped with different clutch according to customer requirement	(46) (33)	
	01.90 -						
	01.90 -						
28.402 F14	01.88 -	D2865LF	 3400 122 201 ⊗ 3482 083 032 ⊗ 1878 004 832 ⊙ 3151 000 034	430 10 MFZ430 430WGTZ KZISZ-5			
			 1882 017 131	420 GF420XN	Nebenantriebs-ID / PTO ID: 130E	(48)	
			 1878 086 941	420 10 420WGTZ	Nebenantriebs-ID / PTO ID: 130E	(48)	
30.342 F14 41.342 VF F14	01.94 -	D2865	 3400 122 301 ⊗ 3482 083 032 ⊗ 1878 080 034 ⊙ 3151 000 034	430 10 MFZ430 430WGTZ KZISZ-5			
	05.94 - 06.96						
 1882 017 131	420 GF420XN	Nebenantriebs-ID / PTO ID: 130E	(48)				
 1878 086 941	420 10 420WGTZ	Nebenantriebs-ID / PTO ID: 130E	(48)				
30.362 F13,14 31.362 F13,14	01.87 -	D2866KF, LXF	 3400 122 201 ⊗ 3482 083 032 ⊗ 1878 004 832 ⊙ 3151 000 034	430 10 MFZ430 430WGTZ KZISZ-5			
	01.87 -						
30.402 F14	01.94 -	D2866	 3400 122 201 ⊗ 3482 083 032 ⊗ 1878 004 832 ⊙ 3151 000 034	430 10 MFZ430 430WGTZ KZISZ-5			
		D2865	 1882 017 131	420 GF420XN	Nebenantriebs-ID / PTO ID: 130E	(48)	
			 1878 086 941	420 10 420WGTZ	Nebenantriebs-ID / PTO ID: 130E	(48)	
31.342 F14 32.342 F14	01.94 -	D2865	 3400 122 301 ⊗ 3482 083 032 ⊗ 1878 080 034 ⊙ 3151 000 034	430 10 MFZ430 430WGTZ KZISZ-5			
	01.94 -						























		CODE				
--	--	------	--	---	---	---

MAN

F 90		06.86 - 12.97					
31.402 F14	01.94 -	D2866	 3400 122 201 ⊗ 3482 083 032 ⊗ 1878 004 832 ⬢ 3151 000 034	430 10 MFZ430 430WGTZ KZISZ-5			
32.262 VF F13	02.89 - 02.90	D2865LF	 3400 700 310 ⊗ 3482 078 133 ⊗ 1862 364 133 ⬢ 3151 000 034	400 10 MFZ400 400WGVZ KZISZ-5	F09,10,13,14 Nabenprofil / Hub Profile: 1 3/4"-10N		(46)
32.262 VFK F13	02.89 - 02.90						
32.262 VFTM F13	02.89 - 02.90						
32.272 VF F13	02.90 - 04.95	D2865LF	 3400 700 310 ⊗ 3482 078 133 ⊗ 1862 364 133 ⬢ 3151 000 034	400 10 MFZ400 400WGVZ KZISZ-5	F09,10,13,14 Nabenprofil / Hub Profile: 1 3/4"-10N		(46)
32.272 VFK F13	02.90 - 04.95		 1882 017 131	420 GF420XN	Nebenantriebs-ID / PTO ID: 130E		(48)
			 1878 086 941	420 10 420WGTZ	Nebenantriebs-ID / PTO ID: 130E		(48)
32.302 VF F13	05.90 - 09.91	D2866LF04	 3400 127 601 ⊗ 3482 078 133 ⊗ 1862 364 031 ⬢ 3151 000 034	400 10 MFZ400 400WGVZ KZISZ-5	F10,13,14 Nabenprofil / Hub Profile: 2"-10N		(46)
32.302 VFK F13	05.90 - 09.91		 1882 017 131	420 GF420XN	Nebenantriebs-ID / PTO ID: 130E		(48)
			 1878 086 941	420 10 420WGTZ	Nebenantriebs-ID / PTO ID: 130E		(48)
			 3151 204 001	KZI-6	mit Schmierrohranschluß / with lubricating pipe coupling Nebenantriebs-ID / PTO ID: 130E		(91) (48)
32.322 VF F13	02.90 - 06.96	D2865LF03, D2865LF06	 3400 127 601 ⊗ 3482 078 133 ⊗ 1862 364 031 ⬢ 3151 000 034	400 10 MFZ400 400WGVZ KZISZ-5	E15,F10,13,14 Nabenprofil / Hub Profile: 2"-10N		(46)
32.322 VFK F13	02.90 - 06.96						
32.332 VF F13	03.88 - 02.90	D2866LF08	 3400 127 601 ⊗ 3482 078 133 ⊗ 1862 364 031 ⬢ 3151 000 034	400 10 MFZ400 400WGVZ KZISZ-5	E15,F09,10,13,14 Nabenprofil / Hub Profile: 2"-10N Je nach Kundenwunsch mit unterschiedlicher Kupplung / Equipped with different clutch according to customer requirement		(46) (33)
32.332 VFK F13	03.88 - 02.90		 3400 122 201 ⊗ 3482 083 032 ⊗ 1878 004 832 ⬢ 3151 000 034	430 10 MFZ430 430WGTZ KZISZ-5	E15,F09,10,13,14 Je nach Kundenwunsch mit unterschiedlicher Kupplung / Equipped with different clutch according to customer requirement		(33)
32.362 VF F13	03.88 - 02.90	D2866KF, KU, LXF	 3400 122 201 ⊗ 3482 083 032 ⊗ 1878 004 832 ⬢ 3151 000 034	430 10 MFZ430 430WGTZ KZISZ-5	E15,F09,10,13,14		
32.362 VFK F13	03.88 - 02.90		 1882 017 131	420 GF420XN	Nebenantriebs-ID / PTO ID: 130		(48)
			 1878 086 941	420 10 420WGTZ	Nebenantriebs-ID / PTO ID: 130		(48)
32.372 VF F13	02.90 - 06.96	D2866LF01, 03, 05	 3400 127 601 ⊗ 3482 078 133 ⊗ 1862 364 031 ⬢ 3151 000 034	400 10 MFZ400 400WGVZ KZISZ-5	E15,F10,13,14 Nabenprofil / Hub Profile: 2"-10N Je nach Kundenwunsch mit unterschiedlicher Kupplung / Equipped with different clutch according to customer requirement		(46) (33)
32.372 VFK F13	02.90 - 06.96		 3400 122 201 ⊗ 3482 083 032 ⊗ 1878 004 832 ⬢ 3151 000 034	430 10 MFZ430 430WGTZ KZISZ-5	E15,F10,13,14 Je nach Kundenwunsch mit unterschiedlicher Kupplung / Equipped with different clutch according to customer requirement		(33)
32.402 F14	01.94 -	D2866	 3400 122 201 ⊗ 3482 083 032 ⊗ 1878 004 832 ⬢ 3151 000 034	430 10 MFZ430 430WGTZ KZISZ-5			
41.402 VF F14	05.94 - 06.96		 1882 017 131	420 GF420XN	Nebenantriebs-ID / PTO ID: 130E		(48)
			 1878 086 941	420 10 420WGTZ	Nebenantriebs-ID / PTO ID: 130E		(48)
32.422 VF F13	02.90 - 06.96	D2866LF06, 09	 3400 122 201 ⊗ 3482 083 032 ⊗ 1878 004 832 ⬢ 3151 000 034	430 10 MFZ430 430WGTZ KZISZ-5	E15,F10,13,14		
32.422 VFK F13	02.90 - 06.96						



























		CODE				
--	--	------	--	---	---	---

























MAN

F 90		06.86 - 12.97					
33.242 DFAK F09 33.242 DFK F09	01.88 - 08.88	D2866F/240	 3400 700 310 ⊗ 3482 078 133 ⊗ 1862 364 133 ⊙ 3151 000 034	400 10 MFZ400 400WGVZ KZISZ-5	F09,10 Nabenprofil / Hub Profile: 1 3/4"-10N	(46)	
	01.88 - 08.88		 3483 023 003 ⊕	445 GMFZ445W	für Fahrzeuge mit Wandlerschaltkupplung / for vehicles with converter and clutch unit	(76)	
			 1878 051 801	445 24 445GTZC	für Fahrzeuge mit Wandlerschaltkupplung / for vehicles with converter and clutch unit	(76)	
33.262 DF F09 33.262 DFK F09	08.88 - 02.90	D2865LF	 3400 700 310 ⊗ 3482 078 133 ⊗ 1862 364 133 ⊙ 3151 000 034	400 10 MFZ400 400WGVZ KZISZ-5	F09,10,13,14 Nabenprofil / Hub Profile: 1 3/4"-10N	(46)	
	08.88 - 02.90		 1882 017 131	420 GF420XN	F09,10,13,14 Nebenantriebs-ID / PTO ID: 230E	(48)	
			 1878 086 941	420 10 420WGTZ	F09,10,13,14 Nebenantriebs-ID / PTO ID: 230E	(48)	
	08.88 - 02.90	D2865LF/260	 3483 023 003 ⊕	445 GMFZ445W	für Fahrzeuge mit Wandlerschaltkupplung / for vehicles with converter and clutch unit	(76)	
			 1878 051 801	445 24 445GTZC	für Fahrzeuge mit Wandlerschaltkupplung / for vehicles with converter and clutch unit	(76)	
33.262 DFA F10 33.262 DFAK F10	07.89 - 02.90	D2865LF	 3400 700 310 ⊗ 3482 078 133 ⊗ 1862 364 133 ⊙ 3151 000 034	400 10 MFZ400 400WGVZ KZISZ-5	F09,10,13,14 Nabenprofil / Hub Profile: 1 3/4"-10N	(46)	
	07.89 - 02.90		 1882 017 131	420 GF420XN	F09,10,13,14 Nebenantriebs-ID / PTO ID: 230E	(48)	
			 1878 086 941	420 10 420WGTZ	F09,10,13,14 Nebenantriebs-ID / PTO ID: 230E	(48)	
	07.89 - 02.90	D2865LF/260	 3483 023 001 ⊕	445 GMFZ445W	für Fahrzeuge mit Wandlerschaltkupplung / for vehicles with converter and clutch unit	(76)	
			 1878 051 801	445 24 445GTZC	für Fahrzeuge mit Wandlerschaltkupplung / for vehicles with converter and clutch unit	(76)	
33.272 F13,14	01.90 -	D2865LF01, 02, 04, 05	 3400 700 310 ⊗ 3482 078 133 ⊗ 1862 364 133 ⊙ 3151 000 034	400 10 MFZ400 400WGVZ KZISZ-5	Nabenprofil / Hub Profile: 1 3/4"-10N	(46)	
		D2865LF	 1882 017 131	420 GF420XN	Nebenantriebs-ID / PTO ID: 130E	(48)	
			 1878 086 941	420 10 420WGTZ	Nebenantriebs-ID / PTO ID: 130E	(48)	
33.292 DF F10 33.292 DFA F10 33.292 DFAK F10 33.292 DFAS F10 33.332 DFA F10 33.332 DFAK F10 33.332 DFAS F10	09.87 - 02.90	D2866LF08	 3400 127 601 ⊗ 3482 078 133 ⊗ 1862 364 031 ⊙ 3151 000 034	400 10 MFZ400 400WGVZ KZISZ-5	F09,10,13,14 Nabenprofil / Hub Profile: 2"-10N Je nach Kundenwunsch mit unterschiedlicher Kupplung / Equipped with different clutch according to customer requirement	(46) (33)	
	05.88 - 02.90		 3400 122 201 ⊗ 3482 083 032 ⊗ 1878 004 832 ⊙ 3151 000 034	430 10 MFZ430 430WGTZ KZISZ-5	F09,10,13,14 Je nach Kundenwunsch mit unterschiedlicher Kupplung / Equipped with different clutch according to customer requirement	(33)	
	05.88 - 02.90	D2866LF/290, D2866LF/330	 1882 017 131	420 GF420XN	F09,10,13,14 Nebenantriebs-ID / PTO ID: 130E	(48)	
	05.88 - 02.90		 1878 086 941	420 10 420WGTZ	F09,10,13,14 Nebenantriebs-ID / PTO ID: 130E	(48)	
	05.88 - 02.90		 3483 023 001 ⊕	445 GMFZ445W	für Fahrzeuge mit Wandlerschaltkupplung / for vehicles with converter and clutch unit	(76)	
	05.88 - 02.90		 1878 051 801	445 24 445GTZC	für Fahrzeuge mit Wandlerschaltkupplung / for vehicles with converter and clutch unit	(76)	

		CODE				
--	--	------	--	---	---	---





















MAN

F 90		06.86 - 12.97					
33.292 DFK F09 33.292 DFS F09 33.332 DFK F09 33.332 DFS F09	09.87 - 02.90	D2866LF08 D2866LF/290, D2866LF/330	 3400 127 601 ⊗ 3482 078 133 ⊗ 1862 364 031 ⊙ 3151 000 034	400 10 MFZ400 400WGVZ KZISZ-5	F09,10,13,14 Nabenprofil / Hub Profile: 2"-10N Je nach Kundenwunsch mit unterschiedlicher Kupplung / Equipped with different clutch according to customer requirement	(46) (33)	
	09.87 - 02.90		 3400 122 201 ⊗ 3482 083 032 ⊗ 1878 004 832 ⊙ 3151 000 034	430 10 MFZ430 430WGTZ KZISZ-5	F09,10,13,14 Je nach Kundenwunsch mit unterschiedlicher Kupplung / Equipped with different clutch according to customer requirement	(33)	
	09.87 - 02.90		 1882 017 131	420 GF420XN	F09,10,13,14 Nebenantriebs-ID / PTO ID: 130E	(48)	
			 1878 086 941	420 10 420WGTZ	F09,10,13,14 Nebenantriebs-ID / PTO ID: 130E	(48)	
			 3483 023 003 ⊕	445 GMFZ445W	für Fahrzeuge mit Wandlerschaltkupplung / for vehicles with converter and clutch unit	(76)	
			 1878 051 801	445 24 445GTZC	für Fahrzeuge mit Wandlerschaltkupplung / for vehicles with converter and clutch unit	(76)	
33.302 F10,13,14 36.302 F14	01.90 - 01.90 - 12.93	D2866LF04 D2866LF	 3400 127 601 ⊗ 3482 078 133 ⊗ 1862 364 031 ⊙ 3151 000 034	400 10 MFZ400 400WGVZ KZISZ-5	Nabenprofil / Hub Profile: 2"-10N	(46)	
			 1882 017 131	420 GF420XN	Nebenantriebs-ID / PTO ID: 130E	(48)	
			 1878 086 941	420 10 420WGTZ	Nebenantriebs-ID / PTO ID: 130E	(48)	
			 3151 204 001	KZI-6	mit Schmierrohranschluß / with lubricating pipe coupling Nebenantriebs-ID / PTO ID: 130E	(91) (48)	
33.322 DFA F10	09.91 - 06.96	D2865LF03, D2865LF06	 3400 127 601 ⊗ 3482 078 133 ⊗ 1862 364 031 ⊙ 3151 000 034	400 10 MFZ400 400WGVZ KZISZ-5	F10,13,14 Nabenprofil / Hub Profile: 2"-10N	(46)	
			 1882 017 131	420 GF420XN	Nebenantriebs-ID / PTO ID: 130E	(48)	
			 1878 086 941	420 10 420WGTZ	Nebenantriebs-ID / PTO ID: 130E	(48)	
			 3151 204 001	KZI-6	mit Schmierrohranschluß / with lubricating pipe coupling Nebenantriebs-ID / PTO ID: 130E	(91) (48)	
			 3483 023 001 ⊕	445 GMFZ445W	für Fahrzeuge mit Wandlerschaltkupplung / for vehicles with converter and clutch unit	(76)	
			 1878 051 801	445 24 445GTZC	für Fahrzeuge mit Wandlerschaltkupplung / for vehicles with converter and clutch unit	(76)	
33.332 DF F09	09.87 - 02.90	D2866LF08	 3400 127 601 ⊗ 3482 078 133 ⊗ 1862 364 031 ⊙ 3151 000 034	400 10 MFZ400 400WGVZ KZISZ-5	F09,10,13,14 Nabenprofil / Hub Profile: 2"-10N Je nach Kundenwunsch mit unterschiedlicher Kupplung / Equipped with different clutch according to customer requirement	(46) (33)	
			 3400 122 201 ⊗ 3482 083 032 ⊗ 1878 004 832 ⊙ 3151 000 034	430 10 MFZ430 430WGTZ KZISZ-5	F09,10,13,14 Je nach Kundenwunsch mit unterschiedlicher Kupplung / Equipped with different clutch according to customer requirement	(33)	
			 1882 017 131	420 GF420XN	F09,10,13,14 Nebenantriebs-ID / PTO ID: 130E	(48)	
			 1878 086 941	420 10 420WGTZ	F09,10,13,14 Nebenantriebs-ID / PTO ID: 130E	(48)	
			 3483 023 003 ⊕	445 GMFZ445W	F09 für Fahrzeuge mit Wandlerschaltkupplung / for vehicles with converter and clutch unit	(76)	
			 1878 051 801	445 24 445GTZC	F09 für Fahrzeuge mit Wandlerschaltkupplung / for vehicles with converter and clutch unit	(76)	
33.362 DF F09 33.362 DFS F09	09.87 - 02.90	D2866KF, D2866LXF	 3400 122 201 ⊗ 3482 083 032 ⊗ 1878 004 832 ⊙ 3151 000 034	430 10 MFZ430 430WGTZ KZISZ-5	F09,10,13,14		
	09.87 - 02.90		 1882 017 131	420 GF420XN	Nebenantriebs-ID / PTO ID: 130E	(48)	
			 1878 086 941	420 10 420WGTZ	Nebenantriebs-ID / PTO ID: 130E	(48)	
			 3483 023 003 ⊕	445 GMFZ445W	für Fahrzeuge mit Wandlerschaltkupplung / for vehicles with converter and clutch unit	(76)	
			 1878 051 801	445 24	für Fahrzeuge mit Wandlerschaltkupplung / for vehicles with converter and clutch unit	(76)	

F 90		06.86 - 12.97						
33.362 DFA F10 33.362 DFAK F10 33.362 DFAS F10	05.88 - 02.90	D2866LXF	 3400 122 201 ⊗ 3482 083 032 ⊗ 1878 004 832 ⊙ 3151 000 034	430 10 MFZ430 430WGTZ KZISZ-5	F09,10,13,14			
	05.88 - 02.90		 1882 017 131	420 GF420XN	Nebenantriebs-ID / PTO ID: 130E	(48)		
	05.88 - 02.90		 1878 086 941	420 10 420WGTZ	Nebenantriebs-ID / PTO ID: 130E	(48)		
			 3483 023 001 ⊕	445 GMFZ445W	für Fahrzeuge mit Wandlerschaltkupplung / for vehicles with converter and clutch unit	(76)		
			 1878 051 801	445 24 445GTZC	für Fahrzeuge mit Wandlerschaltkupplung / for vehicles with converter and clutch unit	(76)		
33.362 DFK F09	09.87 - 02.90	D2866KF, D2866LXF	 3400 122 201 ⊗ 3482 083 032 ⊗ 1878 004 832 ⊙ 3151 000 034	430 10 MFZ430 430WGTZ KZISZ-5	F09,10,13,14			
			 1882 017 131	420 GF420XN	Nebenantriebs-ID / PTO ID: 130E	(48)		
			 1878 086 941	420 10 420WGTZ	Nebenantriebs-ID / PTO ID: 130E	(48)		
33.372 DF F10 33.372 DFA F10 33.372 DFAK F10	09.91 - 06.96	D2866LF01, 03, 05	 3400 127 601 ⊗ 3482 078 133 ⊗ 1862 364 031 ⊙ 3151 000 034	400 10 MFZ400 400WGVZ KZISZ-5	F10,13,14 Nabenprofil / Hub Profile: 2"-10N Je nach Kundenwunsch mit unterschiedlicher Kupplung / Equipped with different clutch according to customer requirement	(46) (33)		
	09.91 - 06.96		 3400 122 201 ⊗ 3482 083 032 ⊗ 1878 004 832 ⊙ 3151 000 034	430 10 MFZ430 430WGTZ KZISZ-5	F10,13,14 Je nach Kundenwunsch mit unterschiedlicher Kupplung / Equipped with different clutch according to customer requirement	(33)		
	01.91 - 06.96	D2866LF	 1882 017 131	420 GF420XN	für Nebenantrieb / for PTO	(82)		
			 1878 086 941	420 10 420WGTZ	für Nebenantrieb / for PTO	(82)		
		D2866LF03, D2866LF05, D2866LF15	 3483 023 001 ⊕	445 GMFZ445W	für Fahrzeuge mit Wandlerschaltkupplung / for vehicles with converter and clutch unit	(76)		
			 1878 051 801	445 24 445GTZC	für Fahrzeuge mit Wandlerschaltkupplung / for vehicles with converter and clutch unit	(76)		
33.422 DFA F10 33.422 DFAK F10	09.91 - 06.96	D2866LF06, D2866LF09	 3400 122 201 ⊗ 3482 083 032 ⊗ 1878 004 832 ⊙ 3151 000 034	430 10 MFZ430 430WGTZ KZISZ-5	F10,13,14			
	01.94 - 06.96		 3483 023 001 ⊕	445 GMFZ445W	für Fahrzeuge mit Wandlerschaltkupplung / for vehicles with converter and clutch unit	(76)		
			 1878 051 801	445 24 445GTZC	für Fahrzeuge mit Wandlerschaltkupplung / for vehicles with converter and clutch unit	(76)		
			D2866LF	 1882 017 131	420 GF420XN	Nebenantriebs-ID / PTO ID: 130E	(48)	
				 1878 086 941	420 10 420WGTZ	Nebenantriebs-ID / PTO ID: 130E	(48)	
33.462 DF F29 33.462 DFA F30	07.89 - 02.90	D2840LF460	 3400 122 201 ⊗ 3482 083 032 ⊗ 1878 004 832 ⊙ 3151 000 034	430 10 MFZ430 430WGTZ KZISZ-5	Je nach Kundenwunsch mit unterschiedlicher Kupplung / Equipped with different clutch according to customer requirement	(33)		
	07.89 - 02.90		 3400 121 901 ⊗ 3488 017 333 ⊗ 1862 303 031 ⊙ 3151 000 034	400 10 MFZ2/400X 400WGVZ KZISZ-5	für Fahrzeuge mit Zweischeibenkupplung / for vehicles with double disc clutch Je nach Kundenwunsch mit unterschiedlicher Kupplung / Equipped with different clutch according to customer requirement	(77) (33)		
			 1882 017 131	420 GF420XN	Nebenantriebs-ID / PTO ID: 130E	(48)		
			 1878 086 941	420 10 420WGTZ	Nebenantriebs-ID / PTO ID: 130E	(48)		
			 3483 023 001 ⊕	445 GMFZ445W	für Fahrzeuge mit Wandlerschaltkupplung / for vehicles with converter and clutch unit	(76)		
			 1878 051 801	445 24 445GTZC	für Fahrzeuge mit Wandlerschaltkupplung / for vehicles with converter and clutch unit	(76)		























		CODE				
--	--	------	--	---	---	---

MAN

F 90		06.86 - 12.97					
33.502 DF F29 33.502 DFA F30	09.91 - 06.96	D2840LF01, 04	 3400 122 201 ⊗ 3482 083 032 ⊗ 1878 004 832 ⊙ 3151 000 034	430 10 MFZ430 430WGTZ KZISZ-5	Je nach Kundenwunsch mit unterschiedlicher Kupplung / Equipped with different clutch according to customer requirement	(33)	
	09.91 - 06.96		 3400 121 901 ⊗ 3488 017 333 ⊗ 1862 303 031 ⊙ 3151 000 034	400 10 MFZ2/400X 400WGVZ KZISZ-5	für Fahrzeuge mit Zweischeibenkupplung / for vehicles with double disc clutch Je nach Kundenwunsch mit unterschiedlicher Kupplung / Equipped with different clutch according to customer requirement	(77) (33)	
		D2840LF04, D2840LF01, D2840LF06	 3483 023 001 ⊕	445 GMFZ445W	für Fahrzeuge mit Wandlerschaltkupplung / for vehicles with converter and clutch unit	(76)	
			 1878 051 801	445 24 445GTZC	für Fahrzeuge mit Wandlerschaltkupplung / for vehicles with converter and clutch unit	(76)	
34.322 F14 36.322 F14	01.94 -	D2865LF03, 06	 3400 122 301 ⊗ 3482 083 032 ⊗ 1878 080 034 ⊙ 3151 000 034	430 10 MFZ430 430WGTZ KZISZ-5	Je nach Kundenwunsch mit unterschiedlicher Kupplung / Equipped with different clutch according to customer requirement	(33)	
	01.90 -		 3400 127 601 ⊗ 3482 078 133 ⊗ 1862 364 031 ⊙ 3151 000 034	400 10 MFZ400 400WGVZ KZISZ-5	Nabenprofil / Hub Profile: 2"-10N Je nach Kundenwunsch mit unterschiedlicher Kupplung / Equipped with different clutch according to customer requirement	(46) (33)	
		D2865LF	 1882 017 131	420 GF420XN	Nebenantriebs-ID / PTO ID: 130E	(48)	
			 1878 086 941	420 10 420WGTZ	Nebenantriebs-ID / PTO ID: 130E	(48)	
34.342 F14 36.342 F14	01.94 -	D2865	 3400 122 301 ⊗ 3482 083 032 ⊗ 1878 080 034 ⊙ 3151 000 034	430 10 MFZ430 430WGTZ KZISZ-5			
	01.94 -		 1882 017 131	420 GF420XN	Nebenantriebs-ID / PTO ID: 130E	(48)	
			 1878 086 941	420 10 420WGTZ	Nebenantriebs-ID / PTO ID: 130E	(48)	
			 3151 204 001	KZI-6	mit Schmierrohranschluß / with lubricating pipe coupling Nebenantriebs-ID / PTO ID: 130E	(91) (48)	
34.372 F14	01.90 -	D2865LF01, 03, 06	 3400 127 601 ⊗ 3482 078 133 ⊗ 1862 364 031 ⊙ 3151 000 034	400 10 MFZ400 400WGVZ KZISZ-5	Nabenprofil / Hub Profile: 2"-10N Je nach Kundenwunsch mit unterschiedlicher Kupplung / Equipped with different clutch according to customer requirement	(46) (33)	
			 3400 122 301 ⊗ 3482 083 032 ⊗ 1878 080 034 ⊙ 3151 000 034	430 10 MFZ430 430WGTZ KZISZ-5	Je nach Kundenwunsch mit unterschiedlicher Kupplung / Equipped with different clutch according to customer requirement	(33)	
		D2865LF	 1882 017 131	420 GF420XN	Nebenantriebs-ID / PTO ID: 130E	(48)	
			 1878 086 941	420 10 420WGTZ	Nebenantriebs-ID / PTO ID: 130E	(48)	
34.402 F14 36.402 F14	01.94 -	D2866	 3400 122 201 ⊗ 3482 083 032 ⊗ 1878 004 832 ⊙ 3151 000 034	430 10 MFZ430 430WGTZ KZISZ-5			
	01.94 -		 1882 017 131	420 GF420XN	Nebenantriebs-ID / PTO ID: 130E	(48)	
			 1878 086 941	420 10 420WGTZ	Nebenantriebs-ID / PTO ID: 130E	(48)	
			 3151 204 001	KZI-6	mit Schmierrohranschluß / with lubricating pipe coupling Nebenantriebs-ID / PTO ID: 130E	(91) (48)	























		CODE				
--	--	------	--	---	---	---

MAN

F 90		06.86 - 12.97					
35.262 VF F14	02.89 - 02.90	D2865LF02, D2865LF/260		3400 700 310 ⊗ 3482 078 133 ⊗ 1862 364 133 ⊙ 3151 000 034	400 10 MFZ400 400WGVZ KZISZ-5	Nabenprofil / Hub Profile: 1 3/4"-10N	(46)
35.262 VFK F14	02.89 - 02.90			1882 017 131	420 GF420XN	Nebenantriebs-ID / PTO ID: 130E	(48)
35.262 VFA F14	07.89 - 02.90			1878 086 941	420 10 420WGTZ	Nebenantriebs-ID / PTO ID: 130E	(48)
35.272 VF F14	02.90 - 12.91			3151 204 001	KZI-6	mit Schmierrohranschluß / with lubricating pipe coupling	(91)
35.272 VFK F14	02.90 - 12.92					Nebenantriebs-ID / PTO ID: 130E	(48)
35.292 VF F14	10.88 - 04.95	D2866LF		3400 127 601 ⊗ 3482 078 133 ⊗ 1862 364 031 ⊙ 3151 000 034	400 10 MFZ400 400WGVZ KZISZ-5	-> 12.1993 E15,F14 Nabenprofil / Hub Profile: 2"-10N Je nach Kundenwunsch mit unterschiedlicher Kupplung / Equipped with different clutch according to customer requirement	(46) (33)
35.292 VFK F14	10.88 - 04.95			3400 122 201 ⊗ 3482 083 032 ⊗ 1878 004 832 ⊙ 3151 000 034	430 10 MFZ430 430WGTZ KZISZ-5	-> 12.1993 E15,F14 Je nach Kundenwunsch mit unterschiedlicher Kupplung / Equipped with different clutch according to customer requirement	(33)
				1882 017 131	420 GF420XN	Nebenantriebs-ID / PTO ID: 130E	(48)
				1878 086 941	420 10 420WGTZ	Nebenantriebs-ID / PTO ID: 130E	(48)
				3151 204 001	KZI-6	mit Schmierrohranschluß / with lubricating pipe coupling	(91)
					Nebenantriebs-ID / PTO ID: 130E	(48)	
35.322 VFK E15	02.90 - 06.96	D2865LF03, 06		3400 127 601 ⊗ 3482 078 133 ⊗ 1862 364 031 ⊙ 3151 000 034	400 10 MFZ400 400WGVZ KZISZ-5	Nabenprofil / Hub Profile: 2"-10N	(46)
35.322 VFAK E15	02.90 - 06.96		D2865LF		1882 017 131	420 GF420XN	Nebenantriebs-ID / PTO ID: 130E
				1878 086 941	420 10 420WGTZ	Nebenantriebs-ID / PTO ID: 130E	(48)
				3151 204 001	KZI-6	mit Schmierrohranschluß / with lubricating pipe coupling	(91)
					Nebenantriebs-ID / PTO ID: 130E	(48)	
		D2865LF03, D2865LF06		3483 023 001 ⊕	445 GMFZ445W	für Fahrzeuge mit Wandlerschaltkupplung / for vehicles with converter and clutch unit	(76)
					1878 051 801	445 24 445GTZC	für Fahrzeuge mit Wandlerschaltkupplung / for vehicles with converter and clutch unit
35.322 VK F14	02.90 - 06.96	D2865LF03, 06		3400 127 601 ⊗ 3482 078 133 ⊗ 1862 364 031 ⊙ 3151 000 034	400 10 MFZ400 400WGVZ KZISZ-5	Nabenprofil / Hub Profile: 2"-10N	(46)
35.322 VFK F14	02.90 - 06.96		D2865LF		1882 017 131	420 GF420XN	Nebenantriebs-ID / PTO ID: 130E
				1878 086 941	420 10 420WGTZ	Nebenantriebs-ID / PTO ID: 130E	(48)
				3151 204 001	KZI-6	mit Schmierrohranschluß / with lubricating pipe coupling	(91)
					Nebenantriebs-ID / PTO ID: 130E	(48)	
35.302 VF F14	05.90 - 09.91	D2866LF04		3400 127 601 ⊗ 3482 078 133 ⊗ 1862 364 031 ⊙ 3151 000 034	400 10 MFZ400 400WGVZ KZISZ-5	F14 Nabenprofil / Hub Profile: 2"-10N	(46)
35.302 VF F14	05.90 - 09.91		D2866LF		1882 017 131	420 GF420XN	Nebenantriebs-ID / PTO ID: 130 E
35.302 VFK F14	05.90 - 09.91			1878 086 941	420 10 420WGTZ	Nebenantriebs-ID / PTO ID: 130 E	(48)
35.302 VFK F14	05.90 - 09.91			3151 204 001	KZI-6	mit Schmierrohranschluß / with lubricating pipe coupling	(91)
					Nebenantriebs-ID / PTO ID: 130 E	(48)	



























		CODE				
--	--	------	--	---	---	---

MAN

F 90		06.86 - 12.97					
35.342 VF F14 35.342 VFK F14	05.94 - 06.96	D2865	 3400 122 301 ⊗ 3482 083 032 ⊗ 1878 080 034 ⊙ 3151 000 034	430 10 MFZ430 430WGTZ KZISZ-5	F14		
	05.94 - 06.96		 1882 017 131	420 GF420XN	Nebenantriebs-ID / PTO ID: 130E	(48)	
			 1878 086 941	420 10 420WGTZ	Nebenantriebs-ID / PTO ID: 130E	(48)	
			 3151 204 001	KZI-6	mit Schmierrohrranschluß / with lubricating pipe coupling Nebenantriebs-ID / PTO ID: 130E	(91)	(48)
35.362 F14	01.88 - 12.93	D2866KF	 3400 122 201 ⊗ 3482 083 032 ⊗ 1878 004 832 ⊙ 3151 000 034	430 10 MFZ430 430WGTZ KZISZ-5			
35.372 VF F14 35.372 VFK F14 35.372 VFK	02.90 - 06.96	D2866LF01, 03, 04, 05	 3400 127 601 ⊗ 3482 078 133 ⊗ 1862 364 031 ⊙ 3151 000 034	400 10 MFZ400 400WGVZ KZISZ-5	E15,F14 Nabenprofil / Hub Profile: 2"-10N Je nach Kundenwunsch mit unterschiedlicher Kupplung / Equipped with different clutch according to customer requirement	(46)	(33)
	02.90 - 12.97		 3400 122 201 ⊗ 3482 083 032 ⊗ 1878 004 832 ⊙ 3151 000 034	430 10 MFZ430 430WGTZ KZISZ-5	E15,F14 Je nach Kundenwunsch mit unterschiedlicher Kupplung / Equipped with different clutch according to customer requirement	(33)	
	02.90 - 06.96						
	02.90 - 12.97						
35.402 VF F14 35.402 VFK F14 35.402 VFK	05.94 - 06.96	D2866	 3400 122 201 ⊗ 3482 083 032 ⊗ 1878 004 832 ⊙ 3151 000 034	430 10 MFZ430 430WGTZ KZISZ-5	F14		
	05.94 - 12.97		 1882 017 131	420 GF420XN	Nebenantriebs-ID / PTO ID: 130E	(48)	
	05.94 - 06.96						
	05.94 - 12.97						
35.422 VF F14 35.422 VFK F14 35.422 VFK	02.90 - 06.96	D2866LF09	 3400 122 201 ⊗ 3482 083 032 ⊗ 1878 004 832 ⊙ 3151 000 034	430 10 MFZ430 430WGTZ KZISZ-5			
	02.90 - 12.97		 1882 017 131	420 GF420XN	Nebenantriebs-ID / PTO ID: 130E	(48)	
	02.90 - 06.96						
	02.90 - 12.97						
36.262 36.272 36.292 36.332	01.91 - 01.91 - 01.91 - 01.91 -	D2865LF, D2866LF	 1882 017 131	420 GF420XN	Nebenantriebs-ID / PTO ID: 130E	(48)	
			 1878 086 941	420 10 420WGTZ	Nebenantriebs-ID / PTO ID: 130E	(48)	
	01.88 - 12.93	D2866KF	 3400 122 201 ⊗ 3482 083 032 ⊗ 1878 004 832 ⊙ 3151 000 034	430 10 MFZ430 430WGTZ KZISZ-5			
			 1882 017 131	420 GF420XN	Nebenantriebs-ID / PTO ID: 130E	(48)	
36.372 F14	01.90 -	D2866LF01, 03, 05	 3400 122 201 ⊗ 3482 083 032 ⊗ 1878 004 832 ⊙ 3151 000 034	430 10 MFZ430 430WGTZ KZISZ-5	Je nach Kundenwunsch mit unterschiedlicher Kupplung / Equipped with different clutch according to customer requirement	(33)	
			 3400 127 601 ⊗ 3482 078 133 ⊗ 1862 364 031 ⊙ 3151 000 034	400 10 MFZ400 400WGVZ KZISZ-5	Nabenprofil / Hub Profile: 2"-10N Je nach Kundenwunsch mit unterschiedlicher Kupplung / Equipped with different clutch according to customer requirement	(46)	(33)
			 1882 017 131	420 GF420XN	Nebenantriebs-ID / PTO ID: 130E	(48)	
			 1878 086 941	420 10 420WGTZ	Nebenantriebs-ID / PTO ID: 130E	(48)	
	01.90 -	D2866LF	 3151 204 001	KZI-6	mit Schmierrohrranschluß / with lubricating pipe coupling Nebenantriebs-ID / PTO ID: 130E	(91)	(48)
			 1882 017 131	420 GF420XN	Nebenantriebs-ID / PTO ID: 130E	(48)	
			 1878 086 941	420 10 420WGTZ	Nebenantriebs-ID / PTO ID: 130E	(48)	
			 3151 204 001	KZI-6	mit Schmierrohrranschluß / with lubricating pipe coupling Nebenantriebs-ID / PTO ID: 130E	(91)	(48)

























		CODE				
--	--	------	--	---	---	---

MAN

F 90		06.86 - 12.97					
36.422 F14	01.90-	D2866LF06, 09	 3400 122 201 ⊗ 3482 083 032 ⊗ 1878 004 832 ⊙ 3151 000 034	430 10 MFZ430 430WGTZ KZISZ-5			
		D2866LF	 1882 017 131	420 GF420XN	Nebenantriebs-ID / PTO ID: 130E	(48)	
			 1878 086 941	420 10 420WGTZ	Nebenantriebs-ID / PTO ID: 130E	(48)	
			 3151 204 001	KZI-6	mit Schmierrohranschluß / with lubricating pipe coupling Nebenantriebs-ID / PTO ID: 130E	(91) (48)	
38.372		D2866LF01, 03, 05	 3400 127 601 ⊗ 3482 078 133 ⊗ 1862 364 031 ⊙ 3151 000 034	400 10 MFZ400 400WGVZ KZISZ-5	01.1989-> F17 Nabenprofil / Hub Profile: 2"-10N	(46)	
			 3400 121 901 ⊗ 3488 017 333 ⊗ 1862 303 031 ⊙ 3151 000 034	400 10 MFZ2/400X 400WGVZ KZISZ-5	01.1991-> F12 für Fahrzeuge mit Zweischeibenkupplung / for vehicles with double disc clutch	(77)	
40.362 F12	01.90-	D2866KF	 3400 121 901 ⊗ 3488 017 333 ⊗ 1862 303 031 ⊙ 3151 000 034	400 10 MFZ2/400X 400WGVZ KZISZ-5	für Fahrzeuge mit Zweischeibenkupplung / for vehicles with double disc clutch	(77)	
			 3483 023 001 ⊕	445 GMFZ445W	für Fahrzeuge mit Wandlerschaltkupplung / for vehicles with converter and clutch unit	(76)	
		 1878 051 801	445 24 445GTZC	für Fahrzeuge mit Wandlerschaltkupplung / for vehicles with converter and clutch unit	(76)		
		 3151 032 341	KZIZ-5	für Fahrzeuge mit Wandlerschaltkupplung / for vehicles with converter and clutch unit	(76)		
40.372 DF F11 40.422 F11	12.91 - 06.96	D2866LF01, 03, 05	 3400 121 901 ⊗ 3488 017 333 ⊗ 1862 303 031 ⊙ 3151 000 034	400 10 MFZ2/400X 400WGVZ KZISZ-5	für Fahrzeuge mit Zweischeibenkupplung / for vehicles with double disc clutch	(77)	
	01.90-		 3483 023 001 ⊕	445 GMFZ445W	für Fahrzeuge mit Wandlerschaltkupplung / for vehicles with converter and clutch unit	(76)	
			D2866LF03, D2866LF05, D2866LF15	 1878 051 801	445 24 445GTZC	für Fahrzeuge mit Wandlerschaltkupplung / for vehicles with converter and clutch unit	(76)
40.372 DFA F12 40.402 DFA F12	12.91 - 06.96	D2866LF03, D2866LF05, D2866LF16, D2866LF15	 3483 023 001 ⊕	445 GMFZ445W	für Fahrzeuge mit Wandlerschaltkupplung / for vehicles with converter and clutch unit	(76)	
	05.95 - 06.96		 1878 051 801	445 24 445GTZC	für Fahrzeuge mit Wandlerschaltkupplung / for vehicles with converter and clutch unit	(76)	
				 3151 032 341	KZIZ-5	für Fahrzeuge mit Wandlerschaltkupplung / for vehicles with converter and clutch unit	(76)
40.402 DF F11 40.422 DF F11	05.95 - 06.96	D2866LF16, D2866LF06, D2866LF09	 3400 122 201 ⊗ 3482 083 032 ⊗ 1878 004 832 ⊙ 3151 000 034	430 10 MFZ430 430WGTZ KZISZ-5			
	12.91 - 06.96		 3400 121 901 ⊗ 3488 017 333 ⊗ 1862 303 031 ⊙ 3151 000 034	400 10 MFZ2/400X 400WGVZ KZISZ-5	für Fahrzeuge mit Zweischeibenkupplung / for vehicles with double disc clutch	(77)	
40.422 DFA F12	12.91 - 06.96	D2866LF06, D2866LF09	 3400 122 201 ⊗ 3482 083 032 ⊗ 1878 004 832 ⊙ 3151 000 034	430 10 MFZ430 430WGTZ KZISZ-5	Je nach Kundenwunsch mit unterschiedlicher Kupplung / Equipped with different clutch according to customer requirement	(33)	
			 3400 121 901 ⊗ 3488 017 333 ⊗ 1862 303 031 ⊙ 3151 000 034	400 10 MFZ2/400X 400WGVZ KZISZ-5	für Fahrzeuge mit Zweischeibenkupplung / for vehicles with double disc clutch Je nach Kundenwunsch mit unterschiedlicher Kupplung / Equipped with different clutch according to customer requirement	(77) (33)	
			 3483 023 001 ⊕	445 GMFZ445W	für Fahrzeuge mit Wandlerschaltkupplung / for vehicles with converter and clutch unit	(76)	
			 1878 051 801	445 24 445GTZC	für Fahrzeuge mit Wandlerschaltkupplung / for vehicles with converter and clutch unit	(76)	
			 3151 032 341	KZIZ-5	für Fahrzeuge mit Wandlerschaltkupplung / for vehicles with converter and clutch unit	(76)	
40.462 DF 48.462 VF F15	07.89 - 02.90	D2840LF460	 3400 122 201 ⊗ 3482 083 032 ⊗ 1878 004 832 ⊙ 3151 000 034	430 10 MFZ430 430WGTZ KZISZ-5			
	07.89 - 02.90		 1882 017 131	420 GF420XN	Nebenantriebs-ID / PTO ID: 130E	(48)	
			 1878 086 941	420 10 420WGTZ	Nebenantriebs-ID / PTO ID: 130E	(48)	

		CODE				
--	--	------	--	---	---	---







MAN

F 90		06.86 - 12.97					
40.462 DFA F32 40.502 DFA F32	07.89 - 02.90	D2840LF04, D2840LF460, D2840LF01, D2840LF06	 3400 122 201 ⊗ 3482 083 032 ⊗ 1878 004 832 ⊙ 3151 000 034	430 10 MFZ430 430WGTZ KZISZ-5			
	02.90 - 06.96		 3400 121 901 ⊗ 3488 017 333 ⊗ 1862 303 031 ⊙ 3151 000 034	400 10 MFZ2/400X 400WGVZ KZISZ-5	für Fahrzeuge mit Zweischeibenkupplung / for vehicles with double disc clutch	(77)	
			 3400 700 327 ⊗ 3482 114 031 ⊗ 1878 004 832 ⊙ 3151 263 031	430 10 GMFZ430N 430WGTZ KZISZ-6	für Fahrzeuge mit Nebenantrieb / for vehicles with PTO Nebenantriebs-ID / PTO ID: NMV-221	(73) (48)	
41.262 VF F14 41.262 VFK F14 41.272 VF F14	07.89 - 02.90	D2865LF02, D2865LF/260	 3400 127 601 ⊗ 3482 078 133 ⊗ 1862 364 031 ⊙ 3151 000 034	400 10 MFZ400 400WGVZ KZISZ-5	Nabenprofil / Hub Profile: 2"-10N	(46)	
	07.89 - 02.90		 1882 017 131	420 GF420XN	Nebenantriebs-ID / PTO ID: 130E	(48)	
	02.90 - 12.91		 1878 086 941	420 10 420WGTZ	Nebenantriebs-ID / PTO ID: 130E	(48)	
			 3151 204 001	KZI-6	mit Schmierrohranschluß / with lubricating pipe coupling Nebenantriebs-ID / PTO ID: 130E	(91) (48)	
41.292 VF F14 41.292 VFK F14 41.332 VF F14 41.332 VFK F14	10.88 - 02.90	D2866LF/290, D2866LF/330	 3400 127 601 ⊗ 3482 078 133 ⊗ 1862 364 031 ⊙ 3151 000 034	400 10 MFZ400 400WGVZ KZISZ-5	E15,26,F14 Nabenprofil / Hub Profile: 2"-10N Je nach Kundenwunsch mit unterschiedlicher Kupplung / Equipped with different clutch according to customer requirement	(46) (33)	
	10.88 - 02.90		 3400 122 201 ⊗ 3482 083 032 ⊗ 1878 004 832 ⊙ 3151 000 034	430 10 MFZ430 430WGTZ KZISZ-5	E15,26,F14 Je nach Kundenwunsch mit unterschiedlicher Kupplung / Equipped with different clutch according to customer requirement	(33)	
	10.88 - 02.90		 1882 017 131	420 GF420XN	Nebenantriebs-ID / PTO ID: 130E	(48)	
	10.88 - 02.90		 1878 086 941	420 10 420WGTZ	Nebenantriebs-ID / PTO ID: 130E	(48)	
			 3400 127 601 ⊗ 3482 078 133 ⊗ 1862 364 031 ⊙ 3151 000 034	400 10 MFZ400 400WGVZ KZISZ-5	Nabenprofil / Hub Profile: 2"-10N	(46)	
			 1882 017 131	420 GF420XN	Nebenantriebs-ID / PTO ID: 130E	(48)	
41.302 F14	01.90 - 12.93	D2866LF04	 3400 127 601 ⊗ 3482 078 133 ⊗ 1862 364 031 ⊙ 3151 000 034	400 10 MFZ400 400WGVZ KZISZ-5	Nabenprofil / Hub Profile: 2"-10N	(46)	
			 1882 017 131	420 GF420XN	Nebenantriebs-ID / PTO ID: 130E	(48)	
		D2866	 1878 086 941	420 10 420WGTZ	Nebenantriebs-ID / PTO ID: 130E	(48)	
			 3151 204 001	KZI-6	mit Schmierrohranschluß / with lubricating pipe coupling Nebenantriebs-ID / PTO ID: 130E	(91) (48)	
41.322 VF F14	02.90 - 06.96	D2865LF03, D2865LF06	 3400 127 601 ⊗ 3482 078 133 ⊗ 1862 364 031 ⊙ 3151 000 034	400 10 MFZ400 400WGVZ KZISZ-5	E15,F14 Nabenprofil / Hub Profile: 2"-10N Je nach Kundenwunsch mit unterschiedlicher Kupplung / Equipped with different clutch according to customer requirement	(46) (33)	
			 3400 122 301 ⊗ 3482 083 032 ⊗ 1878 080 034 ⊙ 3151 000 034	430 10 MFZ430 430WGTZ KZISZ-5	E15,F14 Je nach Kundenwunsch mit unterschiedlicher Kupplung / Equipped with different clutch according to customer requirement	(33)	
			 1882 017 131	420 GF420XN	Nebenantriebs-ID / PTO ID: 130E	(48)	
			 1878 086 941	420 10 420WGTZ	Nebenantriebs-ID / PTO ID: 130E	(48)	
			 3400 122 201 ⊗ 3482 083 032 ⊗ 1878 004 832 ⊙ 3151 000 034	430 10 MFZ430 430WGTZ KZISZ-5	E12,15,26,F14		
41.362 VF F14 41.362 VFK F14	10.88 - 02.90	D2866KF, KU, LXF	 1882 017 131	420 GF420XN	Nebenantriebs-ID / PTO ID: 130E	(48)	
		D2866LXF	 1878 086 941	420 10 420WGTZ	Nebenantriebs-ID / PTO ID: 130E	(48)	













		CODE				
--	--	------	--	---	---	---

MAN

F 90 06.86 - 12.97

41.372 VF F14	02.90 - 06.96	D2866LF01, 03, 04, 05	 3400 127 601 ⊗ 3482 078 133 ⊗ 1862 364 031 ⊙ 3151 000 034	400 10 MFZ400 400WGVZ KZISZ-5	E15,F14 Nabenprofil / Hub Profile: 2"-10N Je nach Kundenwunsch mit unterschiedlicher Kupplung / Equipped with different clutch according to customer requirement	(46) (33)
			 3400 122 201 ⊗ 3482 083 032 ⊗ 1878 004 832 ⊙ 3151 000 034	430 10 MFZ430 430WGTZ KZISZ-5	E15,F14 Je nach Kundenwunsch mit unterschiedlicher Kupplung / Equipped with different clutch according to customer requirement	(33)
		D2866	 1882 017 131	420 GF420XN	Nebenantriebs-ID / PTO ID: 130E	(48)
			 1878 086 941	420 10 420WGTZ	Nebenantriebs-ID / PTO ID: 130E	(48)
41.422 VF F14	02.90 - 06.96	D2866LF06, D2866LF09	 3400 122 201 ⊗ 3482 083 032 ⊗ 1878 004 832 ⊙ 3151 000 034	430 10 MFZ430 430WGTZ KZISZ-5	E12,15,26,F14	
			 1882 017 131	420 GF420XN	Nebenantriebs-ID / PTO ID: 130E	(48)
			 1878 086 941	420 10 420WGTZ	Nebenantriebs-ID / PTO ID: 130E	(48)





















F 90 Unterflur 06.86 - 09.96

14.262 U20	01.89 - 12.94	D2865LF	 3400 700 310 ⊗ 3482 078 133 ⊗ 1862 364 133 ⊙ 3151 000 034	400 10 MFZ400 400WGVZ KZISZ-5	Getr. / GBox: ZF Nabenprofil / Hub Profile: 1 3/4"-10N	(46)
			 3400 127 601 ⊗ 3482 078 133 ⊗ 1862 364 031 ⊙ 3151 000 034	400 10 MFZ400 400WGVZ KZISZ-5	Getr. / GBox: Fuller Nabenprofil / Hub Profile: 2"-10N	(46)
14.272 U20	01.90 - 12.94					
17.262 U20	01.89 - 12.94					
17.272 U20	01.90 - 12.94					
16.332 U01,03	01.86 - 12.92	D2866LF, LU	 3400 122 201 ⊗ 3482 083 032 ⊗ 1878 004 832 ⊙ 3151 000 034	430 10 MFZ430 430WGTZ KZISZ-5		
22.332 U05,06	01.86 - 12.92					
25.332 U05,06	01.86 - 12.92					
26.332 U05,06	01.86 - 12.92					
16.372		D2866LF03	 3400 127 601 ⊗ 3482 078 133 ⊗ 1862 364 031 ⊙ 3151 000 034	400 10 MFZ400 400WGVZ KZISZ-5	01.1989-> U11 Nabenprofil / Hub Profile: 2"-10N	(46)
			 3400 122 201 ⊗ 3482 083 032 ⊗ 1878 004 832 ⊙ 3151 000 034	430 10 MFZ430 430WGTZ KZISZ-5	01.1990-> U13	
19.322 U, 19.322 UL, 19.322 ULL U13 U11	02.90 - 05.94	D2865LF03, 06	 3400 127 601 ⊗ 3482 078 133 ⊗ 1862 364 031 ⊙ 3151 000 034	400 10 MFZ400 400WGVZ KZISZ-5	->07.1993 F01,02,03,04,U11 Nabenprofil / Hub Profile: 2"-10N	(46)
			 3400 122 301 ⊗ 3482 083 032 ⊗ 1878 080 034 ⊙ 3151 000 034	430 10 MFZ430 430WGTZ KZISZ-5	08.1993-> F01,02,03,04,U11	
		D2865	 1882 017 131	420 GF420XN		
			 1878 086 941	420 10 420WGTZ		
19.332 U, 19.322 UL, 19.322 ULL U03 U01	07.86 - 02.90	D2866LF, LU	 3400 122 201 ⊗ 3482 083 032 ⊗ 1878 004 832 ⊙ 3151 000 034	430 10 MFZ430 430WGTZ KZISZ-5	U01,03	
			 1882 017 131	420 GF420XN	für Nebenantrieb / for PTO	(82)
		D2866	 1878 086 941	420 10 420WGTZ	für Nebenantrieb / for PTO	(82)

		CODE				
--	--	------	--	---	---	---

























MAN

F 90 Unterflur 06.86 - 09.96

19.362 U,19.362 ULL, 19.362 ULL U01 U03	07.86 - 01.91	D2866KF, LU	 3400 122 201 ⊗ 3482 083 032 ⊗ 1878 004 832 ⊙ 3151 000 034	430 10 MFZ430 430WGTZ KZISZ-5	U01,03,11,13	
		D2866	 1882 017 131	420 GF420XN	für Nebenantrieb / for PTO	(82)
			 1878 086 941	420 10 420WGTZ	für Nebenantrieb / for PTO	(82)
19.372 U,19.372 ULL U11 U13	02.90 - 05.94	D2866LF03	 3400 127 601 ⊗ 3482 078 133 ⊗ 1862 364 031 ⊙ 3151 000 034	400 10 MFZ400 400WGVZ KZISZ-5	U11 Nabenprofil / Hub Profile: 2"-10N	(46)
			 3400 122 201 ⊗ 3482 083 032 ⊗ 1878 004 832 ⊙ 3151 000 034	430 10 MFZ430 430WGTZ KZISZ-5	U13	
		D2866	 1882 017 131	420 GF420XN	für Nebenantrieb / for PTO	(82)
			 1878 086 941	420 10 420WGTZ	für Nebenantrieb / for PTO	(82)
19.422 U,19.422 ULL U13 U11	02.90 - 05.94	D2866LF06, 09	 3400 122 201 ⊗ 3482 083 032 ⊗ 1878 004 832 ⊙ 3151 000 034	430 10 MFZ430 430WGTZ KZISZ-5	F01,02,03,04,U11	
		D2866	 1882 017 131	420 GF420XN	für Nebenantrieb / for PTO	(82)
			 1878 086 941	420 10 420WGTZ	für Nebenantrieb / for PTO	(82)
22.322 U15	01.89 -	D2866LF03, 06	 3400 127 601 ⊗ 3482 078 133 ⊗ 1862 364 031 ⊙ 3151 000 034	400 10 MFZ400 400WGVZ KZISZ-5	Nabenprofil / Hub Profile: 2"-10N	(46)
22.362 U05,06,16 25.362 U05,06,16 26.362 U05,06,16	01.86 -	D2866KF, LU	 3400 122 201 ⊗ 3482 083 032 ⊗ 1878 004 832 ⊙ 3151 000 034	430 10 MFZ430 430WGTZ KZISZ-5		
	01.86 -					
	01.86 -					
22.372	01.90 -	D2866LF03	 3400 127 601 ⊗ 3482 078 133 ⊗ 1862 364 031 ⊙ 3151 000 034	400 10 MFZ400 400WGVZ KZISZ-5	U15 Nabenprofil / Hub Profile: 2"-10N	(46)
					 3400 122 201 ⊗ 3482 083 032 ⊗ 1878 004 832 ⊙ 3151 000 034	430 10 MFZ430 430WGTZ KZISZ-5
22.422 U15	01.89 -	D2866LF06	 3400 122 201 ⊗ 3482 083 032 ⊗ 1878 004 832 ⊙ 3151 000 034	430 10 MFZ430 430WGTZ KZISZ-5		
23.362 U07	01.88 -	D2866LF, KUL	 3400 122 201 ⊗ 3482 083 032 ⊗ 1878 004 832 ⊙ 3151 000 034	430 10 MFZ430 430WGTZ KZISZ-5		
24.322 UNL,24.322 UNLL U15 U16	02.90 - 12.90	D2865LF03	 3400 127 601 ⊗ 3482 078 133 ⊗ 1862 364 031 ⊙ 3151 000 034	400 10 MFZ400 400WGVZ KZISZ-5	U15 Nabenprofil / Hub Profile: 2"-10N	(46)
		D2865	 1882 017 131	420 GF420XN	07.1990-> für Nebenantrieb / for PTO	(82)
			 1878 086 941	420 10 420WGTZ	07.1990-> für Nebenantrieb / for PTO	(82)
			 3151 204 001	KZI-6	07.1990-> für Nebenantrieb / for PTO mit Schmierrohranschluß / with lubricating pipe coupling	(82) (91)
24.332 UNL,24.332 UNLL U05 U06 U07 24.362 UNL,24.362 UNLL U06 U05 U07	10.86 - 02.90	D2866KF, LU	 3400 122 201 ⊗ 3482 083 032 ⊗ 1878 004 832 ⊙ 3151 000 034	430 10 MFZ430 430WGTZ KZISZ-5	U05,06,16	
	10.86 - 02.90					





		CODE				
--	--	------	--	---	---	---



























MAN

F 90 Unterflur		06.86 - 09.96						
24.372 UNL,24.372 UNLL U07 U15 U16	02.90 - 12.90	D2866LF03	 3400 122 201 ⊗ 3482 083 032 ⊗ 1878 004 832 ⊙ 3151 000 034	430 10 MFZ430 430WGTZ KZISZ-5	U16			
			 3400 127 601 ⊗ 3482 078 133 ⊗ 1862 364 031 ⊙ 3151 000 034	400 10 MFZ400 400WGVZ KZISZ-5	U15 Nabenprofil / Hub Profile: 2"-10N	(46)		
		D2866	 1882 017 131	420 GF420XN	07.1990-> für Nebenantrieb / for PTO	(82)		
			 1878 086 941	420 10 420WGTZ	07.1990-> für Nebenantrieb / for PTO	(82)		
			 3151 204 001	KZI-6	07.1990-> für Nebenantrieb / for PTO mit Schmierrohranschluß / with lubricating pipe coupling	(82) (91)		
24.422 UNL,24.422 UNLL U07 U15 U16	02.90 - 12.90	D2866LF06	 3400 122 201 ⊗ 3482 083 032 ⊗ 1878 004 832 ⊙ 3151 000 034	430 10 MFZ430 430WGTZ KZISZ-5	F20,U15			
			 1882 017 131	420 GF420XN	07.1990-> für Nebenantrieb / for PTO	(82)		
		D2866	 1878 086 941	420 10 420WGTZ	07.1990-> für Nebenantrieb / for PTO	(82)		
			 3151 204 001	KZI-6	07.1990-> für Nebenantrieb / for PTO mit Schmierrohranschluß / with lubricating pipe coupling	(82) (91)		
25.322 UNL,25.322 UNLL U16 U15	09.90 - 12.92	D2865LF03	 3400 127 601 ⊗ 3482 078 133 ⊗ 1862 364 031 ⊙ 3151 000 034	400 10 MFZ400 400WGVZ KZISZ-5	U15 Nabenprofil / Hub Profile: 2"-10N	(46)		
			 1882 017 131	420 GF420XN	für Nebenantrieb / for PTO	(82)		
		D2865	 1878 086 941	420 10 420WGTZ	für Nebenantrieb / for PTO	(82)		
25.372 UNL,25.372 UNLL U16 U15 U07	09.90 - 12.92	D2866LF03	 3400 127 601 ⊗ 3482 078 133 ⊗ 1862 364 031 ⊙ 3151 000 034	400 10 MFZ400 400WGVZ KZISZ-5	U15 Nabenprofil / Hub Profile: 2"-10N	(46)		
			 3400 122 201 ⊗ 3482 083 032 ⊗ 1878 004 832 ⊙ 3151 000 034	430 10 MFZ430 430WGTZ KZISZ-5	U16			
		D2866	 1882 017 131	420 GF420XN	für Nebenantrieb / for PTO	(82)		
			 1878 086 941	420 10 420WGTZ	für Nebenantrieb / for PTO	(82)		
		25.422 UNL,25.422 UNLL U07 U16 U15	09.90 - 12.92	D2866LF06	 3400 122 201 ⊗ 3482 083 032 ⊗ 1878 004 832 ⊙ 3151 000 034	430 10 MFZ430 430WGTZ KZISZ-5	U15	
					 1882 017 131	420 GF420XN	für Nebenantrieb / for PTO	(82)
D2866	 1878 086 941			420 10 420WGTZ	für Nebenantrieb / for PTO	(82)		
26.322 UNL,26.322 UNLL U15 U16	09.90 - 05.94	D2865LF03	 3400 127 601 ⊗ 3482 078 133 ⊗ 1862 364 031 ⊙ 3151 000 034	400 10 MFZ400 400WGVZ KZISZ-5	U15,16,18,19 Nabenprofil / Hub Profile: 2"-10N	(46)		
			 1882 017 131	420 GF420XN	für Nebenantrieb / for PTO	(82)		
		D2865	 1878 086 941	420 10 420WGTZ	für Nebenantrieb / for PTO	(82)		
26.372 UNL,26.372 UNLL U15 U16	09.90 - 05.94	D2866LF03	 3400 127 601 ⊗ 3482 078 133 ⊗ 1862 364 031 ⊙ 3151 000 034	400 10 MFZ400 400WGVZ KZISZ-5	U 15 Nabenprofil / Hub Profile: 2"-10N	(46)		
			 3400 122 201 ⊗ 3482 083 032 ⊗ 1878 004 832 ⊙ 3151 000 034	430 10 MFZ430 430WGTZ KZISZ-5	U 16			













		CODE				
--	--	------	--	---	---	---

MAN

F 90 Unterflur		06.86 - 09.96			
26.422 UNL, 26.422 UNLL U16 U15	09.90 - 05.94	D2866LF06	 3400 122 201  3482 083 032  1878 004 832  3151 000 034	430 10 MFZ430 430WGTZ KZISZ-5	U 15

F 2000		01.94 -				
11.153 T72	04.96 -	D0824LFL	 3400 121 701  3482 000 467  1862 506 131  3151 253 031	395 10 MFZ395 395WGTZ KZIZ-4,5	Je nach Kundenwunsch mit unterschiedlicher Kupplung / Equipped with different clutch according to customer requirement	(33)
11.163 T72	04.96 -		 3400 121 801	362 10 MFZ362 362GTZ	Je nach Kundenwunsch mit unterschiedlicher Kupplung / Equipped with different clutch according to customer requirement	(33)
12.153 T72, 74, 76	04.96 -		 3182 005 231	HHISZ-3	Füllmedium: Bremsflüssigkeit / Fill Medium: Brake Fluid	(23)
					Immer erneuern / Renew everytime	(28)
13.153 T74, 76	04.96 -	D0824L, LFL	 3400 121 701  3482 000 467  1862 506 131  3151 253 031	395 10 MFZ395 395WGTZ KZIZ-4,5	Je nach Kundenwunsch mit unterschiedlicher Kupplung / Equipped with different clutch according to customer requirement	(33)
13.163 T74, 76	04.96 -		 3400 121 801	362 10 MFZ362 362GTZ	Je nach Kundenwunsch mit unterschiedlicher Kupplung / Equipped with different clutch according to customer requirement	(33)
14.153 T74, 76, 81, 83	04.96 -		 3182 005 231	HHISZ-3	Füllmedium: Bremsflüssigkeit / Fill Medium: Brake Fluid	(23)
15.153 T81, 83	04.96 -				Immer erneuern / Renew everytime	(28)
15.163 T81, 83	04.96 -		 3400 710 001  3482 120 031  1878 044 631  3182 005 231	362 10 MFZ362 362GTZ HHISZ-3		
18.273 T01, 02, 03	01.94 -	D2865LF	 3400 122 301  3482 083 032  1878 080 034  3151 000 034	430 10 MFZ430 430WGTZ KZISZ-5		
18.293 T01, 02, 03	01.94 -		 3482 114 031	430 GMFZ430N	für Fahrzeuge mit Nebenantrieb / for vehicles with PTO	(73)
18.323 T01, 02, 03	01.94 -		 1862 441 131 #	430 10 430WGTZ	für Nebenantrieb / for PTO	(82)
18.343 T01, 02, 03	01.94 -		 3151 263 031	KZIZ-6	für Nebenantrieb / for PTO	(82)
32.323 T15	01.95 -					
35.293 T15	01.95 -					
35.323 T15, 16	01.95 -					
37.323 T16	01.95 -					
37.343 T16	01.95 -					
41.323 T16	01.95 -					
18.373 T33	01.94 -	D2866LF21	 3400 122 201  3482 083 032  1878 004 832  3151 000 034	430 10 MFZ430 430WGTZ KZISZ-5		
18.403 T33	01.94 -					
18.423 T33	01.94 -					
18.463 T33	01.94 -					
21.373 4x4 FA T34	08.94 -					





MAN

F 2000		01.94 -				
18.373 T31,32		D2866	 3400 122 201  3482 083 032  1878 004 832  3151 000 034	430 10 MFZ430 430WGTZ KZISZ-5		
18.403 T31,32		D2840	 3488 017 447	400 MFZ2/400X	enthält eine Kupplungsscheibe / This part number includes one clutch disc	(66)
18.423 T31,32			 1878 002 643 ▽	400 10 400WGTZ	Lose Kupplungsscheibe / Loose clutch disc	(39)
18.463 T31,32			 3151 262 031	KZISZ-5		
19.404 T31,32			 1878 002 023 △	400 8 400GTZ	In 3483/3488 enthalten / Contained in 3483, 3488	(30)
19.464 T31,32		D2840	 3488 017 447	400 MFZ2/400X	enthält eine Kupplungsscheibe / This part number includes one clutch disc	(66)
19.233 T31			 1878 002 643 ▽	400 10 400WGTZ	Lose Kupplungsscheibe / Loose clutch disc	(39)
19.373 T31,32			 3151 262 031	KZISZ-5		
19.403 T31,32			 1878 002 023 △	400 8 400GTZ	In 3483/3488 enthalten / Contained in 3483, 3488	(30)
19.423 T31,32		01.94 -				
26.464 T48						
33.463 T48						

		CODE				
--	--	------	--	---	---	---









MAN











F 2000		01.94 -				
19.233 FCNG T31		D2866	 3400 122 201 ⊗ 3482 083 032 ⊗ 1878 004 832 ⊙ 3151 000 034	430 10 MFZ430 430WGTZ KZISZ-5		
19.403 FAC T34	01.94 -		 3400 700 327 ⊗ 3482 114 031 ⊗ 1878 004 832 ⊙ 3151 263 031	430 10 GMFZ430N 430WGTZ KZIZ-6	für Fahrzeuge mit Nebenantrieb / for vehicles with PTO für Nebenantrieb / for PTO	(73) (82)
19.403 FAK, FA-KI T34	01.94 -					
19.403 FAS T34	01.94 -					
19.403 FC, FLC, FLLC, FRC, FLRC, F-NL T31 T33 T50 T32	01.94 -					
19.403 FK, FLK, F-KI, FL-KI T32 T31	01.94 -					
19.403 FS, FLS, FLLS, FRS, FLRS, FLLRS T33 T31 T50 T32	01.94 -					
19.423 FAC T34	01.94 - 12.95					
19.423 FAK, FA-KI T34	01.94 -					
19.423 FAS T34	01.94 - 12.95					
19.423 FC, FLC, FLLC, F-NL T31 T32 T33	01.94 -					
19.423 FK, FLK, F-KI, FL-KI T31 T32	01.94 -					
19.423 FS, FLS, FLLS T32 T33 T31	01.94 -					
26.373 DFC, 26.373 DFLC T39 T40	01.94 - 12.95					
26.373 DFK, 26.373 DFLK T39 T40	01.94 - 12.95					
26.373 DFS, 26.373 DFSL T40 T39	01.94 - 12.95					
26.373 FNLC, 26.373 FNLLC, 26.373 FVLC T36 T37 T38	01.94 - 12.95					
26.373 FNLS, 26.373 FVLS T38 T36	01.94 - 12.95					
26.404 T39,40,42,48	01.94 -					
28.373 T48	01.94 -					
28.403 T48	01.94 -					
28.423 T48	01.94 -					
33.403 DFC T48	01.94 -					
33.403 DFK, DF-KI T48	01.94 -					
33.403 DFS, DFRS T48	01.94 -					

F 2000		01.94 -				
19.273 F, FL, FLL T01 T03 T02	01.94 -	D2865LF24, D2865LF20, D2865LF22, D2865LF23, D2865LF21		3400 122 301 • 3482 083 032 • 1878 080 034 • 3151 000 034	430 10 MFZ430 430WGTZ KZISZ-5	
19.273 FA T04	01.94 -			3496 006 000		langer Bügel / long handle (86)
19.273 FAK T04	01.94 -			3482 114 031	430 GMFZ430N	für Fahrzeuge mit Nebenantrieb / for vehicles with PTO (73)
19.273 FK T01	01.94 -			1862 441 131 #	430 10 430WGTZ	für Nebenantrieb / for PTO (82)
19.273 FS,19.273 FLS T01 T02	01.94 - 12.95			3151 263 031	KZIZ-6	für Nebenantrieb / for PTO (82)
19.293 FAC T04	01.94 -					
19.293 FAK T04	01.94 -					
19.293 FAS T04	01.94 -					
19.293 FC,19.293 FLC,19.293 FLLC T01 T02 T20 T03	01.94 -					
19.293 FK,19.293 FLK T01 T02	01.94 -					
19.293 FS,19.293 FLS,19.293 FLLS T02 T01 T03 T20	01.94 -					
19.323 FC,19.323 FLC,19.323 FLLC T01 T02 T03	01.94 - 12.95					
19.323 FS,19.323 FLS,19.323 FLLS T03 T01 T02	01.94 - 12.95					
19.343 FAC T04	01.94 -					
19.343 FAK T04	01.94 -					
19.343 FAS T04	01.94 -					
19.343 FC,19.343 FLC,19.343 FLLC T01 T03 T20 T02	01.94 -					
19.343 FK,19.343 FLK T01 T02	01.94 -					
19.343 FS,19.343 FLS,19.343 FLLS T02 T20 T01 T03	01.94 -					

		CODE				
--	--	------	--	---	---	---















MAN

F 2000		01.94 -					
19.314 FAS T34J	06.98 -	D2866LF34, D2866LF31, D2866LF35		3400 122 201 ⊗ 3482 083 032 ⊗ 1878 004 832 ⊙ 3151 000 034	430 10 MFZ430 430WGTZ KZISZ-5		
19.314 FC, FLC, FLLC, FLLW, FRC, FLRC, FLLRC, FLL, FLLR, F-N T50 T32J T31J T33J	06.98 -						
19.314 FK, FLK, F-KI, FL-KI T32J T31J	06.98 -						
19.314 FS, FLS, FLLS, FRS, FLRS, FLLRS T33J T50 T32J T31J	06.98 -						
19.364 FAC T34J	06.98 -						
19.364 FAK, FA-KI T34J	06.98 -						
19.364 FAS T34J	06.98 -						
19.364 FC, FLC, FLLC, FLLW, FRC, FLRC, FLLRC, FLL, FLLR, F-N T31J T33J T32J T50	06.98 -						
19.364 FK, FLK, F-KI, FL-KI T31J T32J	06.98 -						
19.364 FS, FLS, FLLS, FRS, FLRS, FLLRS T50 T31J T33J T32J	06.98 -						
19.414 FAC T34J	06.98 -						
19.414 FAK, FA-KI T34J	06.98 -						
19.414 FAS T34J	06.98 -						
19.414 FC, FLC, FLLC, FRC, FLRC, FLLRC, FLL, FLLR, F- NL T32J T31J T33J T50	06.98 -						
19.414 FK, FLK, F-KI, FL-KI T31J T32J	06.98 -						
19.414 FS, FLS, FLLS, FRS, FLRS, FLLRS T50 T31J T32J T33J	06.98 -						
26.413 T 36							
26.414							
19.323 FAC T04	01.94 - 12.95	D2865		3400 122 301 ⊗ 3482 083 032 ⊗ 1878 080 034 ⊙ 3151 000 034	430 10 MFZ430 430WGTZ KZISZ-5	E52	
19.323 FAK T04	01.94 - 12.95						
19.323 FAS T04	01.94 - 12.95			3482 114 031	430 GMFZ430N	E52 für Fahrzeuge mit Nebenantrieb / for vehicles with PTO	(73)
19.323 FK, 19.323 FLK T02 T01	01.94 - 12.95	D2865LF		3400 122 301 ⊗ 3482 083 032 ⊗ 1878 080 034 ⊙ 3151 000 034	430 10 MFZ430 430WGTZ KZISZ-5	T01,02,03,04	(82)
19.344 T04,20,E52	01.94 -	D2865LF21		3400 122 301 ⊗ 3482 083 032 ⊗ 1878 080 034 ⊙ 3151 000 034	430 10 MFZ430 430WGTZ KZISZ-5		
21.343 T04	01.94 -						
23.344 T05	04.94 -			3482 114 031	430 GMFZ430N	für Fahrzeuge mit Nebenantrieb / for vehicles with PTO	(73)
24.343 T05,06,E53	01.94 -			1862 441 131 #	430 10 430WGTZ	für Nebenantrieb / for PTO	(82)
28.343 T08	01.94 -			3151 263 031	KZIZ-6	für Nebenantrieb / for PTO	(82)

F 2000		01.94 -					
19.373 FAC T34	01.94-	D2866LF21	 3400 122 201 ⊗ 3482 083 032 ⊗ 1878 004 832 ⊙ 3151 000 034	430 10 MFZ430 430WGTZ KZISZ-5	T31,32,33,34		
19.373 FAK, FA-KI T34	01.94-						
19.373 FAS T34	01.94-		 3400 700 327 ⊗ 3482 114 031 ⊗ 1878 004 832 ⊙ 3151 263 031	430 10 GMFZ430N 430WGTZ KZIZ-6	T31,32,33,34 für Fahrzeuge mit Nebenantrieb / for vehicles with PTO	(73)	
19.373 FC, FLC, FLLC, FRC, FLRC, F-NL T31 T33 T32	01.94-				für Nebenantrieb / for PTO	(82)	
19.373 FK, FLK, F-KI, FL-KI T32 T31	01.94-						
19.373 FS, FLS, FLLS, FRS, FLRS, FLLRS T32 T33 T31	01.94-						
19.404 T34,E61,62	01.94-	D2866LF20	 3400 122 201 ⊗ 3482 083 032 ⊗ 1878 004 832 ⊙ 3151 000 034	430 10 MFZ430 430WGTZ KZISZ-5			
23.404 T35,37	01.94-						
24.403 T35,37	01.94-		 3400 700 327 ⊗ 3482 114 031 ⊗ 1878 004 832 ⊙ 3151 263 031	430 10 GMFZ430N 430WGTZ KZIZ-6	für Fahrzeuge mit Nebenantrieb / for vehicles with PTO	(73)	
24.403 FNLLC T37	01.94-				für Nebenantrieb / for PTO	(82)	
25.403 T37	01.94-						
26.403 DFC,26.403 DFLC T39 T40	01.94-						
26.403 DFK,26.403 DFLK T39 T40	01.94-						
26.403 DFS,26.403 DFLS T39 T40	01.94-						
26.403 FNLC,26.403 FNLLC,26.403 FVLC T38 T36 T37	01.94-						
26.403 FNLS,26.403 FVLS T36 T38	01.94-						
19.404 T50		D2866LF20	 3400 122 201 ⊗ 3482 083 032 ⊗ 1878 004 832 ⊙ 3151 000 034	430 10 MFZ430 430WGTZ KZISZ-5	01.1995 - 05.1996		
			 3400 122 301 ⊗ 3482 083 032 ⊗ 1878 080 034 ⊙ 3151 000 034	430 10 MFZ430 430WGTZ KZISZ-5	06.1996->		
			 3400 700 327 ⊗ 3482 114 031 ⊗ 1878 004 832 ⊙ 3151 263 031	430 10 GMFZ430N 430WGTZ KZIZ-6	01.1996-> für Fahrzeuge mit Nebenantrieb / for vehicles with PTO	(73)	
					für Nebenantrieb / for PTO	(82)	
19.463 FAC T34	01.94-	D2876LF02	 3400 122 201 ⊗ 3482 083 032 ⊗ 1878 004 832 ⊙ 3151 000 034	430 10 MFZ430 430WGTZ KZISZ-5			
19.463 FAK, FA-KI T34	01.94-						
19.463 FAS T34	01.94-		 3400 700 327 ⊗ 3482 114 031 ⊗ 1878 004 832 ⊙ 3151 263 031	430 10 GMFZ430N 430WGTZ KZIZ-6	->07.1999 für Fahrzeuge mit Nebenantrieb / for vehicles with PTO	(73)	
19.463 FC, FLC, FLLC, FRC, FLRC, F-NL T33 T32 T31 T50	01.94-				für Nebenantrieb / for PTO	(82)	
19.463 FK, FLK, F-KI, FL-KI T31 T32	01.94-						
19.463 FS, FLS, FLLS, FRS, FLRS, FLLRS T31 T32 T33 T50	01.94-						
19.464 T34,E61,62	01.94-	D2866LF20	 3400 122 201 ⊗ 3482 083 032 ⊗ 1878 004 832 ⊙ 3151 000 034	430 10 MFZ430 430WGTZ KZISZ-5			
21.403 4x4 FA T34	08.94-						





















		CODE				
--	--	------	--	---	---	---

MAN

F 2000		01.94 -					
19.464 T50		D2876LF02	 3400 122 201 ⊗ 3482 083 032 ⊗ 1878 004 832 ⊙ 3151 000 034	430 10 MFZ430 430WGTZ KZISZ-5	01.1995 - 05.1996		
			 3400 122 301 ⊗ 3482 083 032 ⊗ 1878 080 034 ⊙ 3151 000 034	430 10 MFZ430 430WGTZ KZISZ-5	06.1996->		
			 3400 700 327 ⊗ 3482 114 031 ⊗ 1878 004 832 ⊙ 3151 263 031	430 10 GMFZ430N 430WGTZ KZIZ-6	01.1996-> für Fahrzeuge mit Nebenantrieb / for vehicles with PTO für Nebenantrieb / for PTO	(73) (82)	
19.464 FAK, FA-KI T34J	06.98 -	D2876LF06, D2876LF02, E2866DF01	 3400 122 201 ⊗ 3482 083 032 ⊗ 1878 004 832 ⊙ 3151 000 034	430 10 MFZ430 430WGTZ KZISZ-5			
19.464 FAS T34J	06.98 -		 3400 700 327 ⊗ 3482 114 031 ⊗ 1878 004 832 ⊙ 3151 263 031	430 10 GMFZ430N 430WGTZ KZIZ-6	->07.1999 für Fahrzeuge mit Nebenantrieb / for vehicles with PTO für Nebenantrieb / for PTO	(73) (82)	
19.464 FC, FLC, FLLC, FLL, FRC, FLLR, FLLRC, FLLW, F- NL	06.98 -						
T50 T32J T31J T33J							
19.464 FK, FLK, F-KI, FL-KI T31J T32J	06.98 -						
19.464 FS, FLS, FLLS, FRS, FLRS, FLLRS	06.98 -						
T32J T31J T33J T50							
26.233 FVL CNG T38	09.96 -						
26.463 DFC, DFCL T39 T40	01.94 -						
26.463 DFK,26.463 DFLK T39 T40	01.94 -						
26.463 DFS,26.463 DFLS T40 T39	01.94 -						
26.463 FNLC, FNLLC, FVLC T38 T36 T37	01.94 -						
26.463 FNLS,26.463 FVLS T38 T36	01.94 -						
19.603 FLS, 19604 FLS T62	04.96 -	D2840	 3488 017 447	400 MFZ2/400X	T62 enthält eine Kupplungsscheibe / This part number includes one clutch disc	(66)	
			 1878 002 643 ▽	400 10 400WGTZ	T62 Lose Kupplungsscheibe / Loose clutch disc	(39)	
			 3151 262 031	KZISZ-5	T62		
			 1878 002 023 △	400 8 400GTZ	T62 In 3483/3488 enthalten / Contained in 3483, 3488	(30)	
21.273 T04	01.94 -	D2865LF22	 3400 122 301 ⊗ 3482 083 032 ⊗ 1878 080 034 ⊙ 3151 000 034	430 10 MFZ430 430WGTZ KZISZ-5			
26.273 T06-10,12,E53,69	01.94 -						
21.293 T04	01.94 -	D2865LF24	 3400 122 301 ⊗ 3482 083 032 ⊗ 1878 080 034 ⊙ 3151 000 034	430 10 MFZ430 430WGTZ KZISZ-5			
33.293 T12	01.94 -						
21.323 T04	01.94 -	D2865LF23	 3400 122 301 ⊗ 3482 083 032 ⊗ 1878 080 034 ⊙ 3151 000 034	430 10 MFZ430 430WGTZ KZISZ-5			
26.323 T06-10,12,E53	01.94 -						
33.323 T12	01.94 -						
21.423 4x4 FA T34	08.94 -	D2866LF22	 3400 122 201 ⊗ 3482 083 032 ⊗ 1878 004 832 ⊙ 3151 000 034	430 10 MFZ430 430WGTZ KZISZ-5			
21.463 4x4 FA T34	08.94 -	D2876LF02	 3400 122 201 ⊗ 3482 083 032 ⊗ 1878 004 832 ⊙ 3151 000 034	430 10 MFZ430 430WGTZ KZISZ-5			







		CODE		 Parameter		
--	--	------	--	---	---	---

MAN

F 2000		01.94 -					
23.273 T05 24.273 T05,06,E53	04.94 -	D2865LF22	 3400 122 301  3482 083 032  1878 080 034  3151 000 034	430 10 MFZ430 430WGTZ KZISZ-5			
	01.94 -		 3482 114 031	430 GMFZ430N	für Fahrzeuge mit Nebenantrieb / for vehicles with PTO (73) für Nebenantrieb / for PTO (82)		
			 1862 441 131 #	430 10 430WGTZ	für Nebenantrieb / for PTO (82)		
			 3151 263 031	KZIZ-6	für Nebenantrieb / for PTO (82)		
23.293 FNLLC T05	01.94 -	D2865LF24	 3400 122 301  3482 083 032  1878 080 034  3151 000 034	430 10 MFZ430 430WGTZ KZISZ-5	04.1994-> T05		
	01.94 -		 3482 114 031	430 GMFZ430N	04.1994-> T05 für Fahrzeuge mit Nebenantrieb / for vehicles with PTO (73) für Nebenantrieb / for PTO (82)		
			 1862 441 131 #	430 10 430WGTZ	04.1994-> T05 für Nebenantrieb / for PTO (82)		
			 3151 263 031	KZIZ-6	04.1994-> T05 für Nebenantrieb / for PTO (82)		
23.323 T05 24.323 T05,06,E53 28.323 T08	04.94 -	D2865LF23	 3400 122 301  3482 083 032  1878 080 034  3151 000 034	430 10 MFZ430 430WGTZ KZISZ-5			
	01.94 -		 3482 114 031	430 GMFZ430N	für Fahrzeuge mit Nebenantrieb / for vehicles with PTO (73) für Nebenantrieb / for PTO (82)		
	01.94 -		 1862 441 131 #	430 10 430WGTZ	für Nebenantrieb / for PTO (82)		
			 3151 263 031	KZIZ-6	für Nebenantrieb / for PTO (82)		



















		CODE		 Parameter		
--	--	------	--	---	---	---

MAN

F 2000		01.94 -						
23.343 FNLLC T05	01.94 -	D2865LF24, D2865LF22, D2865LF21, D2865LF23		3400 122 301 ⊗ 3482 083 032 ⊗ 1878 080 034 ⊙ 3151 000 034	430 10 MFZ430 430WGTZ KZISZ-5			
24.273 FNLLC T07	01.94 - 12.95				3482 114 031	430 GMFZ430N	für Fahrzeuge mit Nebenantrieb / for vehicles with PTO für Nebenantrieb / for PTO	(73)
24.293 FNLLC T07	01.94 -				1862 441 131 #	430 10 430WGTZ	für Nebenantrieb / for PTO	(82)
24.323 FNLLC T07	01.94 - 12.95				3151 263 031	KZIZ-6	für Nebenantrieb / for PTO	(82)
24.343 FNLLC T07	01.94 -							
26.273 DFC,26.273 DFLC T09 T10	01.94 - 12.95							
26.273 DFK,26.273 DFLK T10 T09	01.94 - 12.95							
26.273 DFS,26.273 DFLS T10 T09	01.94 - 12.95							
26.273 FNLC,26.273 FNLLC,26.273 FVLC T08 T06 T07	01.94 - 12.95							
26.273 FNLS,26.273 FVLS T06 T08	01.94 - 12.95							
26.323 DFC,26.323 DFLC T09 T10	01.94 - 12.95							
26.323 DFK,26.323 DFLK T10 T09	01.94 - 12.95							
26.323 DFS,26.323 DFLS T09 T10	01.94 - 12.95							
26.323 FNLC,26.323 FNLLC,26.323 FVLC T07 T06 T08	01.94 - 12.95							
26.323 FNLS,26.323 FVLS T06 T08	01.94 - 12.95							
27.273 DFC T18	01.94 - 12.95							
27.273 DFK T18	01.94 - 12.95							
27.273 DFS T18	01.94 - 12.95							
27.323 DFC T18	01.94 - 12.95							
27.323 DFK, DF-KI T18	01.94 -							
27.323 DFS T18	01.94 - 12.95							
27.343 DFC T18	01.94 -							
27.343 DFK T18	01.94 -							
27.343 DFS T18	01.94 -							
23.373 T35,37	01.94 -	D2866LF21, D2866LF20, D2866LF22, D2876LF02		3400 122 201 ⊗ 3482 083 032 ⊗ 1878 004 832 ⊙ 3151 000 034	430 10 MFZ430 430WGTZ KZISZ-5			
23.403 FNLLC T35	01.94 -				3400 700 327 ⊗ 3482 114 031 ⊗ 1878 004 832 ⊙ 3151 263 031	430 10 GMFZ430N 430WGTZ KZIZ-6	für Fahrzeuge mit Nebenantrieb / for vehicles with PTO für Nebenantrieb / for PTO	(73)
23.463 FNLLC T35	01.94 -							(82)
24.373 FNLLC T37	01.94 - 12.95							
26.423 FNLC,26.423 FNLLC,26.423 FVLC T38 T36 T37	01.94 - 12.95							
26.423 FNLS,26.423 FVLS T36 T38	01.94 - 12.95							





















		CODE				
--	--	------	--	---	---	---

MAN

F 2000		01.94 -					
23.423 T35,37	01.94 -	D2866LF22	 3400 122 201 ⊗ 3482 083 032 ⊗ 1878 004 832 ⊙ 3151 000 034	430 10 MFZ430 430WGTZ KZISZ-5			
24.423 T35,37	01.94 -						
24.423 FNLLC T37	01.94 - 12.95		 3400 700 327 ⊗ 3482 114 031 ⊗ 1878 004 832 ⊙ 3151 263 031	430 10 GMFZ430N 430WGTZ KZISZ-6	für Fahrzeuge mit Nebenantrieb / for vehicles with PTO für Nebenantrieb / for PTO	(73)	(82)
23.464 T35,37	01.94 -	D2876LF02	 3400 122 201 ⊗ 3482 083 032 ⊗ 1878 004 832 ⊙ 3151 000 034	430 10 MFZ430 430WGTZ KZISZ-5			
24.463 T35,37	01.94 -						
24.463 FNLLC T37	01.94 -		 3400 700 327 ⊗ 3482 114 031 ⊗ 1878 004 832 ⊙ 3151 263 031	430 10 GMFZ430N 430WGTZ KZISZ-6	für Fahrzeuge mit Nebenantrieb / for vehicles with PTO für Nebenantrieb / for PTO	(73)	(82)
24.293 T05,06,E53	01.94 -	D2865LF24	 3400 122 301 ⊗ 3482 083 032 ⊗ 1878 080 034 ⊙ 3151 000 034	430 10 MFZ430 430WGTZ KZISZ-5			
28.293 T08	01.94 -		 3482 114 031	430 GMFZ430N	für Fahrzeuge mit Nebenantrieb / for vehicles with PTO für Nebenantrieb / for PTO	(73)	(82)
			 1862 441 131 #	430 10 430WGTZ	für Nebenantrieb / for PTO		(82)
			 3151 263 031	KZISZ-6	für Nebenantrieb / for PTO		(82)
26.293 DFC,26.293 DFCL T10 T09	01.94 -	D2865LF24	 3400 122 301 ⊗ 3482 083 032 ⊗ 1878 080 034 ⊙ 3151 000 034	430 10 MFZ430 430WGTZ KZISZ-5	T08,09,10,12,E53		
26.293 DFK,26.293 DFLK T09 T10	01.94 -						
26.293 DFS,26.293 DFLS T10 T09	01.94 -		 3482 114 031	430 GMFZ430N	T08,09,10,E53 für Fahrzeuge mit Nebenantrieb / for vehicles with PTO für Nebenantrieb / for PTO	(73)	(82)
26.293 FNLC,26.293 FNLLC,26.293 FVLC T07 T08 T06	01.94 -		 1862 441 131 #	430 10 430WGTZ	T08,09,10,12,E53 für Nebenantrieb / for PTO		(82)
26.293 FNLS,26.293 FVLS T06 T08	01.94 -		 3151 263 031	KZISZ-6	T08,09,10,E53 für Nebenantrieb / for PTO		(82)
26.343 DFC,26.343 DFCL T09 T10	01.94 -	D2865LF21	 3400 122 301 ⊗ 3482 083 032 ⊗ 1878 080 034 ⊙ 3151 000 034	430 10 MFZ430 430WGTZ KZISZ-5	T06-10,12,E53		
26.343 DFK,26.343 DFLK T10 T09	01.94 -						
26.343 DFS,26.343 DFLS T09 T10	01.94 -		 3482 114 031	430 GMFZ430N	T08,09,10,E53 für Fahrzeuge mit Nebenantrieb / for vehicles with PTO für Nebenantrieb / for PTO	(73)	(82)
26.343 FNLC,26.343 FNLLC,26.343 FVLC T06 T08 T07	01.94 -		 1862 441 131 #	430 10 430WGTZ	T06-10,12,E53 für Nebenantrieb / for PTO		(82)
26.343 FNLS,26.343 FVLS T06 T08	01.94 -		 3151 263 031	KZISZ-6	T08,09,10,E53 für Nebenantrieb / for PTO		(82)
26.373 DF T42			 3483 023 003 ⊕	445 GMFZ445W	für Fahrzeuge mit Wandlerschaltkupplung / for vehicles with converter and clutch unit	(76)	
26.404 DF T42			 1878 051 801	445 24 445GTZC	für Fahrzeuge mit Wandlerschaltkupplung / for vehicles with converter and clutch unit	(76)	
26.423 DF T42							
26.464 DF T42							





















		CODE				
--	--	------	--	---	---	---

MAN

F 2000		01.94 -					
26.423 DFC,26.423 DFLC T39 T40	01.94 - 12.95	D2866	 3400 122 201 ⊗ 3482 083 032 ⊗ 1878 004 832 ⊙ 3151 000 034	430 10 MFZ430 430WGTZ KZISZ-5	T39,40,42,48		
26.423 DFK,26.423 DFLK T40 T39	01.94 - 12.95						
26.423 DFS,26.423 DFLS T40 T39	01.94 - 12.95		 3400 700 327 ⊗ 3482 114 031 ⊗ 1878 004 832 ⊙ 3151 263 031	430 10 GMFZ430N 430WGTZ KZIZ-6	T39,40,48 für Fahrzeuge mit Nebenantrieb / for vehicles with PTO für Nebenantrieb / for PTO	(73)	(82)
27.373 DFC T48	01.94 -						
27.373 DFK, DF-KI T48	01.94 -						
27.373 DFS T48	01.94 -						
27.423 DFC T48	01.94 -						
27.423 DFK, DF-KI T48	01.94 -						
27.423 DFS T48	01.94 -						
26.463 T48		D2876	 3400 122 201 ⊗ 3482 083 032 ⊗ 1878 004 832 ⊙ 3151 000 034	430 10 MFZ430 430WGTZ KZISZ-5			
			 3482 114 031	430 GMFZ430N	für Fahrzeuge mit Nebenantrieb / for vehicles with PTO für Nebenantrieb / for PTO	(73)	(82)
			 1862 441 131 #	430 10 430WGTZ	für Nebenantrieb / for PTO	(82)	
			 3151 263 031	KZIZ-6	für Nebenantrieb / for PTO	(82)	
		D2840	 3488 017 447	400 MFZ2/400X	enthält eine Kupplungsscheibe / This part number includes one clutch disc	(66)	
			 1878 002 643 ▽	400 10 400WGTZ	Lose Kupplungsscheibe / Loose clutch disc	(39)	
			 3151 262 031	KZISZ-5			
			 1878 002 023 △	400 8 400GTZ	In 3483/3488 enthalten / Contained in 3483, 3488	(30)	
26.464 T39,40,48 27.463 DFK, DF-KI T48 27.463 DFS T48 33.463 DFC T48 33.463 DFK, DF-KI T48 33.463 DFS, DFRS T48	01.94 -	D2876	 3400 122 201 ⊗ 3482 083 032 ⊗ 1878 004 832 ⊙ 3151 000 034	430 10 MFZ430 430WGTZ KZISZ-5			
	01.94 -						
	01.94 -		 3400 700 327 ⊗ 3482 114 031 ⊗ 1878 004 832 ⊙ 3151 263 031	430 10 GMFZ430N 430WGTZ KZIZ-6	für Fahrzeuge mit Nebenantrieb / for vehicles with PTO für Nebenantrieb / for PTO	(73)	(82)
	01.94 -						
	01.94 -						
26.603 DFC, DFLC T78 T70 26.603 DFK, DFLK T70 T78 26.603 DFS, DFLS T70 T78	06.96 -	D2840LF20	 3488 017 447	400 MFZ2/400X	T70 enthält eine Kupplungsscheibe / This part number includes one clutch disc	(66)	
	06.96 -		 1878 002 643 ▽	400 10 400WGTZ	T70 Lose Kupplungsscheibe / Loose clutch disc	(39)	
	06.96 -		 3151 262 031	KZISZ-5	T70		
			 1878 002 023 △	400 8 400GTZ	T70 In 3483/3488 enthalten / Contained in 3483, 3488	(30)	
27.273 DFAC T12 27.273 DFAK T12 27.273 DFAS T12	01.94 - 12.95	D2865LF22	 3400 122 301 ⊗ 3482 083 032 ⊗ 1878 080 034 ⊙ 3151 000 034	430 10 MFZ430 430WGTZ KZISZ-5	T05,08,09,10,12		
	01.94 - 12.95						
	01.94 - 12.95	D2865, 2866	 3482 114 031	430 GMFZ430N	T05,08-10,E53,69 für Fahrzeuge mit Nebenantrieb / for vehicles with PTO für Nebenantrieb / for PTO	(73)	(82)
			 1862 441 131 #	430 10 430WGTZ	T05,08-10,E53,69 für Nebenantrieb / for PTO	(82)	
			 3151 263 031	KZIZ-6	T05,08-10,E53,69 für Nebenantrieb / for PTO	(82)	























		CODE				
--	--	------	--	---	---	---

MAN

F 2000		01.94 -					
27.293 DFAC T12 27.293 DFAK T12 27.293 DFAS T12	01.94-	D2865LF24	 3400 122 301 ⊗ 3482 083 032 ⊗ 1878 080 034 ⊙ 3151 000 034	430 10 MFZ430 430WGTZ KZISZ-5	T05,08,09,10,12		
	01.94-		 3482 114 031	430 GMFZ430N	T05,08,09,10,E53 für Fahrzeuge mit Nebenantrieb / for vehicles with PTO für Nebenantrieb / for PTO	(73)	(82)
	01.94-		 1862 441 131 #	430 10 430WGTZ	T05,08,09,10,12 für Nebenantrieb / for PTO	(82)	(82)
			 3151 263 031	KZIZ-6	T05,08,09,10,E53 für Nebenantrieb / for PTO	(82)	(82)
27.293 DFC T18 27.293 DFK T18 27.293 DFS T18	01.94-	D2865LF24	 3400 122 301 ⊗ 3482 083 032 ⊗ 1878 080 034 ⊙ 3151 000 034	430 10 MFZ430 430WGTZ KZISZ-5			
	01.94-		 3482 114 031	430 GMFZ430N	für Fahrzeuge mit Nebenantrieb / for vehicles with PTO für Nebenantrieb / for PTO	(73)	(82)
	01.94-		 1862 441 131 #	430 10 430WGTZ	für Nebenantrieb / for PTO	(82)	(82)
			 3151 263 031	KZIZ-6	für Nebenantrieb / for PTO	(82)	(82)
27.323 DFAC T12 27.323 DFAK, DFA-KI T12 27.323 DFAS T12	01.94 - 12.95	D2865LF23	 3400 122 301 ⊗ 3482 083 032 ⊗ 1878 080 034 ⊙ 3151 000 034	430 10 MFZ430 430WGTZ KZISZ-5	T05,08,09,10,12		
	01.94-		 3482 114 031	430 GMFZ430N	T05,08,09,10,E53 für Fahrzeuge mit Nebenantrieb / for vehicles with PTO für Nebenantrieb / for PTO	(73)	(82)
	01.94 - 12.95		 1862 441 131 #	430 10 430WGTZ	T05,08,09,10,12 für Nebenantrieb / for PTO	(82)	(82)
			 3151 263 031	KZIZ-6	T05,08,09,10,E53 für Nebenantrieb / for PTO	(82)	(82)
27.343 DFAC T12 27.343 DFAK T12 27.343 DFAS T12	01.94-	D2865LF21	 3400 122 301 ⊗ 3482 083 032 ⊗ 1878 080 034 ⊙ 3151 000 034	430 10 MFZ430 430WGTZ KZISZ-5	T05,08,09,10,12		
	01.94-		 3482 114 031	430 GMFZ430N	T05,08,09,10,E53 für Fahrzeuge mit Nebenantrieb / for vehicles with PTO für Nebenantrieb / for PTO	(73)	(82)
	01.94-		 1862 441 131 #	430 10 430WGTZ	T05,08,09,10,12 für Nebenantrieb / for PTO	(82)	(82)
			 3151 263 031	KZIZ-6	T05,08,09,10,E53 für Nebenantrieb / for PTO	(82)	(82)
27.373 DFAC T42 27.373 DFAK, DFA-KI T42 27.373 DFAS T42 27.403 DFAC T42 27.403 DFAK, DFA-KI T42 27.403 DFAS T42 27.423 DFAC T42 27.423 DFAK, DFA-KI T42 27.423 DFAS T42	01.94-	D2866	 3400 122 201 ⊗ 3482 083 032 ⊗ 1878 004 832 ⊙ 3151 000 034	430 10 MFZ430 430WGTZ KZISZ-5	T39,40,42,48		
	01.94-		 3483 023 003 ⊕	445 GMFZ445W	für Fahrzeuge mit Wandlerschaltkupplung / for vehicles with converter and clutch unit	(76)	
	01.94-		 1878 051 801	445 24 445GTZC	für Fahrzeuge mit Wandlerschaltkupplung / for vehicles with converter and clutch unit	(76)	
	01.94 - 12.95						
27.402 T39,40,42	01.94-	D2866LF16	 3400 122 201 ⊗ 3482 083 032 ⊗ 1878 004 832 ⊙ 3151 000 034	430 10 MFZ430 430WGTZ KZISZ-5			





















































		CODE				
--	--	------	--	---	---	---

MAN

F 2000		01.94 -						
27.403 DFC T48 27.403 DFK, DF-KI T48 27.403 DFS T48	01.94-	D2866	 3400 122 201 ⊗ 3482 083 032 ⊗ 1878 004 832 ⊙ 3151 000 034	430 10 MFZ430 430WGTZ KZISZ-5	T39,40,42,48			
	01.94-		 3482 114 031	430 GMFZ430N	T39,40,48 für Fahrzeuge mit Nebenantrieb / for vehicles with PTO für Nebenantrieb / for PTO	(73)	(82)	
	01.94-		 1878 004 832	430 10 430WGTZ	T39,40,48 für Nebenantrieb / for PTO	(82)		
	01.94-		 3151 000 034	KZISZ-5	T39,40,48 für Nebenantrieb / for PTO	(82)		
27.463 DFAC T42 27.463 DFAK, DFA-KI T42 27.463 DFAS T42 33.463 DFAC T42 33.463 DFAK, DFA-KI T42 33.463 DFAS T42	01.94-	D2876	 3400 122 201 ⊗ 3482 083 032 ⊗ 1878 004 832 ⊙ 3151 000 034	430 10 MFZ430 430WGTZ KZISZ-5				
	01.94-		 3400 700 327 ⊗ 3482 114 031 ⊗ 1878 004 832 ⊙ 3151 263 031	430 10 GMFZ430N 430WGTZ KZISZ-6	für Fahrzeuge mit Nebenantrieb / for vehicles with PTO für Nebenantrieb / for PTO	(73)	(82)	
	01.94-	D2876LF02	 3483 023 003 ⊕	445 GMFZ445W	für Fahrzeuge mit Wandlerschaltkupplung / for vehicles with converter and clutch unit	(76)		
	01.94-		 1878 051 801	445 24 445GTZC	für Fahrzeuge mit Wandlerschaltkupplung / for vehicles with converter and clutch unit	(76)		
	01.94-		 3400 122 201 ⊗ 3482 083 032 ⊗ 1878 004 832 ⊙ 3151 000 034	430 10 MFZ430 430WGTZ KZISZ-5				
	01.94-		 3400 700 327 ⊗ 3482 114 031 ⊗ 1878 004 832 ⊙ 3151 263 031	430 10 GMFZ430N 430WGTZ KZISZ-6	für Fahrzeuge mit Nebenantrieb / for vehicles with PTO für Nebenantrieb / for PTO	(73)	(82)	
27.463 DFC T48 28.463 T48 38.463 T48	01.94-	D2876	 3400 122 201 ⊗ 3482 083 032 ⊗ 1878 004 832 ⊙ 3151 000 034	430 10 MFZ430 430WGTZ KZISZ-5				
	01.94-		 3400 700 327 ⊗ 3482 114 031 ⊗ 1878 004 832 ⊙ 3151 263 031	430 10 GMFZ430N 430WGTZ KZISZ-6	für Fahrzeuge mit Nebenantrieb / for vehicles with PTO für Nebenantrieb / for PTO	(73)	(82)	
		D2840	 3488 017 447	400 MFZ2/400X	enthält eine Kupplungsscheibe / This part number includes one clutch disc	(66)		
			 1878 002 643 ▽	400 10 400WGTZ	Lose Kupplungsscheibe / Loose clutch disc	(39)		
			 3151 262 031	KZISZ-5				
		 1878 002 023 △	400 8 400GTZ	In 3483/3488 enthalten / Contained in 3483, 3488	(30)			
27.603 DFAS T72 33.603 DFAC T72 33.603 DFAS T72	01.96-	D2840LF20	 3488 017 447	400 MFZ2/400X	enthält eine Kupplungsscheibe / This part number includes one clutch disc	(66)		
	06.96-		 1878 002 643 ▽	400 10 400WGTZ	Lose Kupplungsscheibe / Loose clutch disc	(39)		
	06.96-		 3151 262 031	KZISZ-5				
	06.96-		 1878 002 023 △	400 8 400GTZ	In 3483/3488 enthalten / Contained in 3483, 3488	(30)		
27.603 DFS T78 33.603 DFC T78 33.603 DFS T78	01.96-	D2840LF20	 3488 017 447	400 MFZ2/400X	T78 enthält eine Kupplungsscheibe / This part number includes one clutch disc	(66)		
	06.96-		 1878 002 643 ▽	400 10 400WGTZ	T78 Lose Kupplungsscheibe / Loose clutch disc	(39)		
	06.96-		 3151 262 031	KZISZ-5	T78			
	06.96-		1878 002 023 △	400 8 400GTZ	T78 In 3483/3488 enthalten / Contained in 3483, 3488	(30)		
28.273 T08	01.94-	D2865	3400 122 301 ⊗ 3482 083 032 ⊗ 1878 080 034 ⊙ 3151 000 034	430 10 MFZ430 430WGTZ KZISZ-5				
		D2865, 2866	3482 114 031	430 GMFZ430N	T08,E69 für Fahrzeuge mit Nebenantrieb / for vehicles with PTO für Nebenantrieb / for PTO	(73)	(82)	
			1862 441 131 #	430 10 430WGTZ	T08,E69 für Nebenantrieb / for PTO	(82)		
			3151 263 031	KZISZ-6	T08,E69 für Nebenantrieb / for PTO	(82)		





















		CODE					
--	--	------	--	--	---	---	---

MAN

F 2000		01.94 -					
28.603 T70,78	01.96-	D2840LF20	 3488 017 447	400 MFZ2/400X	enthält eine Kupplungsscheibe / This part number includes one clutch disc		(66)
			 1878 002 643 ▽	400 10 400WGTZ	Lose Kupplungsscheibe / Loose clutch disc		(39)
			 3151 262 031	KZISZ-5			
			 1878 002 023 △	400 8 400GTZ	In 3483/3488 enthalten / Contained in 3483, 3488		(30)
32.293 VFC T15 32.343 VFC T15	08.95-	D2865LF	 3400 122 301  3482 083 032  1878 080 034  3151 000 034	430 10 MFZ430 430WGTZ KZISZ-5	T15		
	08.95-		 3482 114 031	430 GMFZ430N	T15 für Fahrzeuge mit Nebenantrieb / for vehicles with PTO		(73)
			 1862 441 131 #	430 10 430WGTZ	T15 für Nebenantrieb / for PTO		(82)
			 3151 263 031	KZIZ-6	T15 für Nebenantrieb / for PTO		(82)
			 3400 122 301  3482 083 032  1878 080 034  3151 000 034	430 10 MFZ430 430WGTZ KZISZ-5	T15 für Fahrzeuge mit Nebenantrieb / for vehicles with PTO		(73)
32.343 VFK T15	08.95-	D2865LF	 3482 114 031	430 GMFZ430N	T15 für Fahrzeuge mit Nebenantrieb / for vehicles with PTO		(73)
			 1862 441 131 #	430 10 430WGTZ	-> 02.1996 T15 für Nebenantrieb / for PTO		(82)
			 3151 263 031	KZIZ-6	T15 für Nebenantrieb / for PTO		(82)
			 3400 122 201  3482 083 032  1878 004 832  3151 000 034	430 10 MFZ430 430WGTZ KZISZ-5	-> 05.1996		
32.373 T45,46 35.373 T45,46 37.373 T45,46	01.94-	D2866LF21	 3400 122 301  3482 083 032  1878 080 034  3151 000 034	430 10 MFZ430 430WGTZ KZISZ-5	06.1996->		
	01.94-		 3400 700 327  3482 114 031  1878 004 832  3151 263 031	430 10 GMFZ430N 430WGTZ KZIZ-6	für Fahrzeuge mit Nebenantrieb / for vehicles with PTO für Nebenantrieb / for PTO		(73) (82)
	01.94-		 3400 122 201  3482 083 032  1878 004 832  3151 000 034	430 10 MFZ430 430WGTZ KZISZ-5	T45,46		
32.403 VFC T45	08.95-	D2866LF20	 3482 114 031	430 GMFZ430N	T45,46 für Fahrzeuge mit Nebenantrieb / for vehicles with PTO		(73)
			 1862 441 131 #	430 10 430WGTZ	06.1996-> T45,46 für Nebenantrieb / for PTO		(82)
			 3151 263 031	KZIZ-6	T45,46 für Nebenantrieb / for PTO		(82)
			 3400 122 201  3482 083 032  1878 004 832  3151 000 034	430 10 MFZ430 430WGTZ KZISZ-5	T45,46		
32.403 VFK T45	08.95-	D2866LF20	 3400 122 301  3482 083 032  1878 080 034  3151 000 034	430 10 MFZ430 430WGTZ KZISZ-5	06.1996-> T45,46		
			 3482 114 031	430 GMFZ430N	T45,46 für Fahrzeuge mit Nebenantrieb / for vehicles with PTO		(73)
			 1862 441 131 #	430 10 430WGTZ	06.1996-> T45,46 für Nebenantrieb / for PTO		(82)
			 3151 263 031	KZIZ-6	T45,46 für Nebenantrieb / for PTO		(82)
				 3400 122 201  3482 083 032  1878 004 832  3151 000 034	430 10 MFZ430 430WGTZ KZISZ-5	T45,46 für Nebenantrieb / for PTO	





















		CODE					
--	--	------	--	--	---	---	---

MAN

F 2000		01.94 -					
32.423 T45,46	01.94-	D2866LF22		3400 122 201 ⊗ 3482 083 032 ⊗ 1878 004 832 ⊙ 3151 000 034	430 10 MFZ430 430WGTZ KZISZ-5	->05.1996	
35.423 T45,46	01.94-						
37.423 T45,46	01.94-			3400 122 301 ⊗ 3482 083 032 ⊗ 1878 080 034 ⊙ 3151 000 034	430 10 MFZ430 430WGTZ KZISZ-5	06.1996->	
41.423 T45,46	01.94-			3400 700 327 ⊗ 3482 114 031 ⊗ 1878 004 832 ⊙ 3151 263 031	430 10 GMFZ430N 430WGTZ KZIZ-6	für Fahrzeuge mit Nebenantrieb / for vehicles with PTO für Nebenantrieb / for PTO	(73) (82)
32.463 VFC T45	08.95-	D2876LF02		3400 122 201 ⊗ 3482 083 032 ⊗ 1878 004 832 ⊙ 3151 000 034	430 10 MFZ430 430WGTZ KZISZ-5	T45,46	
32.463 VFK T45	08.95-			3482 114 031	430 GMFZ430N	T45,46 für Fahrzeuge mit Nebenantrieb / for vehicles with PTO für Nebenantrieb / for PTO	(73) (82)
				1862 441 131 #	430 10 430WGTZ	06.1996-> T45,46 für Nebenantrieb / for PTO	(82)
				3151 263 031	KZIZ-6	T45,46 für Nebenantrieb / for PTO	(82)
33.273 T12,E69	01.94-	D2865, 2866		3400 122 301 ⊗ 3482 083 032 ⊗ 1878 080 034 ⊙ 3151 000 034	430 10 MFZ430 430WGTZ KZISZ-5		
33.323 DFAC T12	01.94 - 12.95	D2865LF23		3400 122 301 ⊗ 3482 083 032 ⊗ 1878 080 034 ⊙ 3151 000 034	430 10 MFZ430 430WGTZ KZISZ-5		
33.323 DFAK T12	01.94 - 12.95						
33.323 DFAS T12	01.94 - 12.95						
33.323 DFC T18	01.94 - 12.95	D2865LF23		3400 122 301 ⊗ 3482 083 032 ⊗ 1878 080 034 ⊙ 3151 000 034	430 10 MFZ430 430WGTZ KZISZ-5		
33.323 DFK T18	01.94 - 12.95			3482 114 031	430 GMFZ430N	für Fahrzeuge mit Nebenantrieb / for vehicles with PTO für Nebenantrieb / for PTO	(73) (82)
33.323 DFS T18	01.94 - 12.95			1862 441 131 #	430 10 430WGTZ	für Nebenantrieb / for PTO	(82)
33.343 DFC T18	01.94-			3151 263 031	KZIZ-6	für Nebenantrieb / for PTO	(82)
33.343 DFK T18	01.94-						
33.343 DFS T18	01.94-						
33.343 DFAC T12	01.94-	D2865LF21		3400 122 301 ⊗ 3482 083 032 ⊗ 1878 080 034 ⊙ 3151 000 034	430 10 MFZ430 430WGTZ KZISZ-5	T12	
33.343 DFAK T12	01.94-						
33.343 DFAS T12	01.94-						
33.373 DFAC T42	01.94-	D2866LF21		3400 122 201 ⊗ 3482 083 032 ⊗ 1878 004 832 ⊙ 3151 000 034	430 10 MFZ430 430WGTZ KZISZ-5		
33.373 DFAK, DFA-KI T42	01.94-						
33.373 DFAS T42	01.94-			3400 700 327 ⊗ 3482 114 031 ⊗ 1878 004 832 ⊙ 3151 263 031	430 10 GMFZ430N 430WGTZ KZIZ-6	für Fahrzeuge mit Nebenantrieb / for vehicles with PTO für Nebenantrieb / for PTO	(73) (82)
				3483 023 003 ⊕	445 GMFZ445W	für Fahrzeuge mit Wandlerschaltkupplung / for vehicles with converter and clutch unit	(76)
				1878 051 801	445 24 445GTZC	für Fahrzeuge mit Wandlerschaltkupplung / for vehicles with converter and clutch unit	(76)
33.373 DFC T48	01.94-	D2866LF21		3400 122 201 ⊗ 3482 083 032 ⊗ 1878 004 832 ⊙ 3151 000 034	430 10 MFZ430 430WGTZ KZISZ-5		
33.373 DFK, DF-KI T48	01.94-						
33.373 DFS, DFRS T48	01.94-			3400 700 327	430 10	für Fahrzeuge mit Nebenantrieb / for vehicles with PTO für Nebenantrieb / for PTO	(73) (82)





















































		CODE				
--	--	------	--	---	---	---

MAN

F 2000		01.94 -					
33.403 DFAC T42 33.403 DFAK, DFA-KI T42 33.403 DFAS T42	01.94-	D2866		3400 122 201 ⊗ 3482 083 032 ⊗ 1878 004 832 ⊙ 3151 000 034	430 10 MFZ430 430WGTZ KZISZ-5		
	01.94-			3400 700 327 ⊗ 3482 114 031 ⊗ 1878 004 832 ⊙ 3151 263 031	430 10 GMFZ430N 430WGTZ KZIZ-6	für Fahrzeuge mit Nebenantrieb / for vehicles with PTO für Nebenantrieb / for PTO	(73) (82)
		D2866LF20		3483 023 003 ⊕	445 GMFZ445W	für Fahrzeuge mit Wandlerschaltkupplung / for vehicles with converter and clutch unit	(76)
				1878 051 801	445 24 445GTZC	für Fahrzeuge mit Wandlerschaltkupplung / for vehicles with converter and clutch unit	(76)
33.423 DFAC T42 33.423 DFAK, DFA-KI T42 33.423 DFAS T42	01.94-	D2866LF22		3400 122 201 ⊗ 3482 083 032 ⊗ 1878 004 832 ⊙ 3151 000 034	430 10 MFZ430 430WGTZ KZISZ-5		
	01.94-			3483 023 003 ⊕	445 GMFZ445W	für Fahrzeuge mit Wandlerschaltkupplung / for vehicles with converter and clutch unit	(76)
	01.94-			1878 051 801	445 24 445GTZC	für Fahrzeuge mit Wandlerschaltkupplung / for vehicles with converter and clutch unit	(76)
		D2866		3400 700 327 ⊗ 3482 114 031 ⊗ 1878 004 832 ⊙ 3151 263 031	430 10 GMFZ430N 430WGTZ KZIZ-6	für Fahrzeuge mit Nebenantrieb / for vehicles with PTO für Nebenantrieb / for PTO	(73) (82)
33.423 DFC T48 33.423 DFK, DF-KI T48 33.423 DFS, DFRS T48	01.94-	D2866LF22		3400 122 201 ⊗ 3482 083 032 ⊗ 1878 004 832 ⊙ 3151 000 034	430 10 MFZ430 430WGTZ KZISZ-5		
	01.94-	D2866		3400 700 327 ⊗ 3482 114 031 ⊗ 1878 004 832 ⊙ 3151 263 031	430 10 GMFZ430N 430WGTZ KZIZ-6	für Fahrzeuge mit Nebenantrieb / for vehicles with PTO für Nebenantrieb / for PTO	(73) (82)
35.314 VF (FE310A) T46 35.364 VF. (FE360A) T46 35.403 VF, VFC, VFRC T46 35.403 VFK, VF-HK, VF-KI T46 35.414 VF. (FE410A) T46 35.463 VF, VFC, VFRC T46 35.463 VFK, VF-HK, VF-KI T46 41.364 VF. (FE360A) T46 41.403 VF, VFC, VFRC T46 41.403 VFK, VF-HK, VF-KI T46 41.414 VF. (FE410A) T46 41.463 VF, VFC, VFRC T46 41.463 VFK, VF-HK, VF-KI T46	06.98-	D2866LF20		3400 122 201 ⊗ 3482 083 032 ⊗ 1878 004 832 ⊙ 3151 000 034	430 10 MFZ430 430WGTZ KZISZ-5		
	06.98-			3488 017 447	400 MFZ2/400X	für Fahrzeuge mit Zweischeibenkupplung / for vehicles with double disc clutch enthält eine Kupplungsscheibe / This part number includes one clutch disc	(77) (66)
	08.95-			1878 002 643	400 10 400WGTZ	für Fahrzeuge mit Zweischeibenkupplung / for vehicles with double disc clutch	(77)
	03.02-			3151 262 031	KZISZ-5	für Fahrzeuge mit Zweischeibenkupplung / for vehicles with double disc clutch	(77)
	06.98-			3400 700 327 ⊗ 3482 114 031 ⊗ 1878 004 832 ⊙ 3151 263 031	430 10 GMFZ430N 430WGTZ KZIZ-6	für Fahrzeuge mit Nebenantrieb / for vehicles with PTO für Nebenantrieb / for PTO	(73) (82)
	08.95-			3496 006 000		langer Bügel / long handle	(86)
	08.95-						
	08.95-						
	08.95-						
	08.95-						
35.343 VFC T16 35.343 VFK T16	08.95-	D2865LF		3400 122 301 ⊗ 3482 083 032 ⊗ 1878 080 034 ⊙ 3151 000 034	430 10 MFZ430 430WGTZ KZISZ-5	T15,16	
	08.95-			3482 114 031	430 GMFZ430N	für Fahrzeuge mit Nebenantrieb / for vehicles with PTO für Nebenantrieb / for PTO	(73) (82)
				1862 441 131 #	430 10 430WGTZ	für Nebenantrieb / for PTO	(82)
				3151 263 031	KZIZ-6	für Nebenantrieb / for PTO	(82)

		CODE				
--	--	------	--	---	---	---















MAN

F 2000		01.94 -					
35.364 VFAK E68 35.414 VFAK E68 35.464 VFAK E68 41.364 VFAK E68 41.414 VFAK E68 41.464 VFAK E68 50.414 VFK/VFAK E68 50.464 VFK/VFAK E68		D2876LF03, D2866LF24, D2866LF25	 3400 122 201  3482 083 032  1878 004 832  3151 000 034	430 10 MFZ430 430WGTZ KZISZ-5	Getr. / GBox: ZF / Eaton		
				 3488 017 447	400 MFZ2/400X	Getr. / GBox: ZF / Eaton für Fahrzeuge mit Zweischeibenkupplung / for vehicles with double disc clutch enthält eine Kupplungsscheibe / This part number includes one clutch disc	(77) (66)
				 1878 002 643	400 10 400WGTZ	Getr. / GBox: ZF / Eaton für Fahrzeuge mit Zweischeibenkupplung / for vehicles with double disc clutch	(77)
				 3151 262 031	KZISZ-5	Getr. / GBox: ZF / Eaton für Fahrzeuge mit Zweischeibenkupplung / for vehicles with double disc clutch	(77)
				 3483 023 003 ⊕	445 GMFZ445W	für Fahrzeuge mit Wandlerschaltkupplung / for vehicles with converter and clutch unit	(76)
				 1878 051 801	445 24 445GTZC	für Fahrzeuge mit Wandlerschaltkupplung / for vehicles with converter and clutch unit	(76)
				 3400 122 201  3482 083 032  1878 004 832  3151 000 034	430 10 MFZ430 430WGTZ KZISZ-5		
35.464 VF. (FE460A) T46	06.98 -	D2876LF03	 3400 700 327  3482 114 031  1878 004 832  3151 263 031	430 10 GMFZ430N 430WGTZ KZIZ-6	für Fahrzeuge mit Nebenantrieb / for vehicles with PTO für Nebenantrieb / for PTO	(73) (82)	
				 3496 006 000		langer Bügel / long handle	(86)
				 3483 023 003 ⊕	445 GMFZ445W	für Fahrzeuge mit Wandlerschaltkupplung / for vehicles with converter and clutch unit	(76)
35.604 E94 40.604 E94 41.604 E95 50.604 E98	08.98 - 03.04	D2840LF21					
	08.98 - 03.04						
	02.97 - 03.04						
	03.99 - 04.03						
37.403 T45,46		D2866LF20	 3400 122 201  3482 083 032  1878 004 832  3151 000 034	430 10 MFZ430 430WGTZ KZISZ-5	01.1994 - 05.1996		
				 3400 122 301  3482 083 032  1878 080 034  3151 000 034	430 10 MFZ430 430WGTZ KZISZ-5	06.1996->	
				 3400 700 327  3482 114 031  1878 004 832  3151 263 031	430 10 GMFZ430N 430WGTZ KZIZ-6	01.1994-> für Fahrzeuge mit Nebenantrieb / for vehicles with PTO für Nebenantrieb / for PTO	(73) (82)
37.463 T45,46		D2876LF02	 3400 122 201  3482 083 032  1878 004 832  3151 000 034	430 10 MFZ430 430WGTZ KZISZ-5	01.1994 - 05.1996		
				 3400 122 301  3482 083 032  1878 080 034  3151 000 034	430 10 MFZ430 430WGTZ KZISZ-5	06.1996->	
				 3400 700 327  3482 114 031  1878 004 832  3151 263 031	430 10 GMFZ430N 430WGTZ KZIZ-6	01.1994-> für Fahrzeuge mit Nebenantrieb / for vehicles with PTO für Nebenantrieb / for PTO	(73) (82)
40.373 T43 40.403 T43 40.423 T43 40.463 T43		D2840	 3488 017 447	400 MFZ2/400X	enthält eine Kupplungsscheibe / This part number includes one clutch disc	(66)	
				 1878 002 643 ▽	400 10 400WGTZ	Lose Kupplungsscheibe / Loose clutch disc	(39)
				 3151 262 031	KZISZ-5		
				 1878 002 023 △	400 8 400GTZ	In 3483/3488 enthalten / Contained in 3483, 3488	(30)
				 3400 700 327  3482 114 031  1878 004 832  3151 263 031	430 10 GMFZ430N 430WGTZ KZIZ-6	für Fahrzeuge mit Nebenantrieb / for vehicles with PTO für Nebenantrieb / for PTO	(73) (82)
40.463		D2876LF01	 3400 122 201	430 10			





		CODE				
--	--	------	--	---	---	---

MAN

F 2000 01.94 -



41.343 VFC T16 41.343 VFK T16	08.95 -	D2865LF		3400 122 301 ⊗ 3482 083 032 ⊗ 1878 080 034 ⊙ 3151 000 034	430 10 MFZ430 430WGTZ KZISZ-5	T16	
	08.95 -			3482 114 031	430 GMFZ430N	T16 für Fahrzeuge mit Nebenantrieb / for vehicles with PTO für Nebenantrieb / for PTO	(73) (82)
				1862 441 131 #	430 10 430WGTZ	T16 für Nebenantrieb / for PTO	(82)
				3151 263 031	KZIZ-6	T16 für Nebenantrieb / for PTO	(82)
41.373 T45,46	01.94 -	D2866LF21		3400 122 201 ⊗ 3482 083 032 ⊗ 1878 004 832 ⊙ 3151 000 034	430 10 MFZ430 430WGTZ KZISZ-5	->05.1996	
				3400 700 327 ⊗ 3482 114 031 ⊗ 1878 004 832 ⊙ 3151 263 031	430 10 GMFZ430N 430WGTZ KZIZ-6	für Fahrzeuge mit Nebenantrieb / for vehicles with PTO für Nebenantrieb / for PTO	(73) (82)
41.464 VF. (FE460A) T46	06.98 -	D2876LF03		3400 122 201 ⊗ 3482 083 032 ⊗ 1878 004 832 ⊙ 3151 000 034	430 10 MFZ430 430WGTZ KZISZ-5		
				3488 017 447	400 MFZ2/400X	für Fahrzeuge mit Zweischeibenkupplung / for vehicles with double disc clutch enthält eine Kupplungsscheibe / This part number includes one clutch disc	(77) (66)
				1878 002 643	400 10 400WGTZ	für Fahrzeuge mit Zweischeibenkupplung / for vehicles with double disc clutch	(77)
				3151 262 031	KZISZ-5	für Fahrzeuge mit Zweischeibenkupplung / for vehicles with double disc clutch	(77)
				3400 700 327 ⊗ 3482 114 031 ⊗ 1878 004 832 ⊙ 3151 263 031	430 10 GMFZ430N 430WGTZ KZIZ-6	für Fahrzeuge mit Nebenantrieb / for vehicles with PTO für Nebenantrieb / for PTO	(73) (82)
				3496 006 000		langer Bügel / long handle	(86)
				3483 023 003 ⊕	445 GMFZ445W	E75 für Fahrzeuge mit Wandlerschaltkupplung / for vehicles with converter and clutch unit	(76)
	1878 051 801	445 24 445GTZC	E75 für Fahrzeuge mit Wandlerschaltkupplung / for vehicles with converter and clutch unit	(76)			









G 10.79 - 08.88





6.90 F 560 6.90 FK 560 8.90 F 560 8.90 FK 560	10.79 - 09.87	D0224		3400 124 201 # ⊗ 3482 032 331 ⊗ 1861 841 132 ⊙ 3151 600 541	280 28 MFZ280 280GTPZ KZIZ-2	560	
	10.79 - 09.87			3400 124 201 # ⊗ 3482 032 331 ⊗ 1861 841 132 ⊙ 3151 600 541	280 28 MFZ280 280GTPZ KZIZ-2	561	
8.136 F,8.136 FL 561 8.136 FK 561	10.79 - 09.87	D0226		3400 124 201 # ⊗ 3482 032 331 ⊗ 1861 841 132 ⊙ 3151 600 541	280 28 MFZ280 280GTPZ KZIZ-2	561	
	10.79 - 08.88			3400 125 801 ⊗ 3482 102 031 ⊗ 1862 219 031 ⊙ 3151 600 541	310 28 MFZ310 310GTPD KZIZ-2	561 Je nach Kundenwunsch mit unterschiedlicher Kupplung / Equipped with different clutch according to customer requirement	(33)
8.136 FA, FAR 565 8.136 FAE 565 9.136 FA, FAR 565 9.136 FAE 565	05.83 - 05.90	D0226MF		3400 125 801 ⊗ 3482 102 031 ⊗ 1862 219 031 ⊙ 3151 600 541	310 28 MFZ310 310GTPD KZIZ-2		
	12.83 - 08.88						
	05.83 - 05.90						
	12.83 - 08.88						

		CODE				
--	--	------	--	---	---	---

MAN



















G 10.79 - 08.88						
9.136 F,9.136 FL 561	10.79-09.87	D0226		3400 124 201 # ⊗ 3482 032 331 ⊗ 1861 841 132 ⊙ 3151 600 541	280 28 MFZ280 280GTPZ KZIZ-2	
9.136 FK 561	10.79-08.88			3400 125 801 ⊗ 3482 102 031 ⊗ 1862 219 031 ⊙ 3151 600 541	310 28 MFZ310 310GTPD KZIZ-2	Je nach Kundenwunsch mit unterschiedlicher Kupplung / Equipped with different clutch according to customer requirement (33)
10.136 F,10.136 FL 491 562	09.81-09.87	D0226		3400 125 801 ⊗ 3482 102 031 ⊗ 1862 219 031 ⊙ 3151 600 541	310 28 MFZ310 310GTPD KZIZ-2	491,562
10.136 FK 491	09.81-09.87					

G 90 09.87 - 05.95						
6.100 F L01	09.87-10.93	D0824F, GF		3400 124 201 # ⊗ 3482 032 331 ⊗ 1861 841 132 ⊙ 3151 600 541	280 28 MFZ280 280GTPZ KZIZ-2	L01
6.100 FK L01	09.87-10.93					
8.100 F L01	09.87-10.93			3400 125 801 ⊗ 3482 102 031 ⊗ 1862 219 031 ⊙ 3151 600 541	310 28 MFZ310 310GTPD KZIZ-2	Je nach Kundenwunsch mit unterschiedlicher Kupplung / Equipped with different clutch according to customer requirement (33)
8.100 FK L01	09.87-10.93					
8.150 F,8.150 FL L02	09.87-10.93	D0826F, GF		3400 125 801 ⊗ 3482 102 031 ⊗ 1862 219 031 ⊙ 3151 600 541	310 28 MFZ310 310GTPD KZIZ-2	L02,03,05
8.150 FK L02	09.87-10.93					
8.150 FS,8.150 FLS L02	09.87-10.93					
9.150 F,9.150 FL L02	09.87-10.93					
9.150 FK L02	09.87-10.93					
9.150 FS,9.150 FLS L02	09.87-10.93					
8.150 FAE L03	05.88-05.95	D0826GF/03		3400 125 801 ⊗ 3482 102 031 ⊗ 1862 219 031 ⊙ 3151 600 541	310 28 MFZ310 310GTPD KZIZ-2	L3
9.150 FAE L03	05.88-05.92					
8.170 L05	01.88-12.94	D0226MCFO		3482 060 233	350 MF350	
9.170 L05	01.88-12.94			1861 777 041 #	350 10 350GTD	
				3151 199 001	KZIS-3	
10.150 F,10.150 FL L04	05.90-10.93	D0226MF		3400 125 801 ⊗ 3482 102 031 ⊗ 1862 219 031 ⊙ 3151 600 541	310 28 MFZ310 310GTPD KZIZ-2	
10.150 F,10.150 FL L04	09.87-10.93	D0826F, GF		3400 125 801 ⊗ 3482 102 031 ⊗ 1862 219 031 ⊙ 3151 600 541	310 28 MFZ310 310GTPD KZIZ-2	L04
10.150 FK L04	09.87-10.93					

L 2000 10.93 -						
6.103 L20 L33	01.93-	D0824FL		3400 700 322 ⊖ ⊗ 3482 093 032 ⊗ 1862 438 032	330 10 MFZ330 330WTB	->03.1996 Je nach Kundenwunsch mit unterschiedlicher Kupplung / Equipped with different clutch according to customer requirement (33)
6.153 L33 L20	01.93-					
6.163 L20	01.93-			3400 121 801 ⊖ ⊗ 3482 120 031 ⊗ 1878 044 631	362 10 MFZ362 362GTZ	Je nach Kundenwunsch mit unterschiedlicher Kupplung / Equipped with different clutch according to customer requirement (33)
7.153 L20 L33	01.93-			3182 005 231	HHISZ-3	Füllmedium: Bremsflüssigkeit / Fill Medium: Brake Fluid (23)
7.163 L20	01.93-			3400 710 001 ⊗ 3482 120 031 ⊗ 1878 044 631 ⊙ 3182 005 231	362 10 MFZ362 362GTZ HHISZ-3	Immer erneuern / Renew everytime (28)



















		CODE				
--	--	------	--	---	---	---

MAN

L 2000		10.93 -				
6.103 L L20 8.163 LAC, LAEC, LARC, LAERC, LA-LF, LAE-LF L22 8.163 LAEC L22	05.93 -	D0824FL	 3400 700 322 ◐ ⊗ 3482 093 032 ⊗ 1862 438 032	330 10 MFZ330 330WTB	Je nach Kundenwunsch mit unterschiedlicher Kupplung / Equipped with different clutch according to customer requirement	(33)
	01.95 -		 3400 121 801 ◐ ⊗ 3482 120 031 ⊗ 1878 044 631	362 10 MFZ362 362GTZ	Je nach Kundenwunsch mit unterschiedlicher Kupplung / Equipped with different clutch according to customer requirement	(33)
	08.95 - 03.97		 3182 005 231	HHISZ-3	Füllmedium: Bremsflüssigkeit / Fill Medium: Brake Fluid Immer erneuern / Renew everytime	(23) (28)
			 3400 710 001 ⊗ 3482 120 031 ⊗ 1878 044 631 ⊗ 3182 005 231	362 10 MFZ362 362GTZ HHISZ-3		
6.164 L20 L33 7.164 L20 L33 8.164 L22 L33 L20 9.164 L20 L33 L22 10.164 L35	01.93 -	D0824LFL	 3400 700 322 ◐ ⊗ 3482 093 032 ⊗ 1862 438 032	330 10 MFZ330 330WTB	Je nach Kundenwunsch mit unterschiedlicher Kupplung / Equipped with different clutch according to customer requirement	(33)
	01.93 -		 3400 121 801 ◐ ⊗ 3482 120 031 ⊗ 1878 044 631	362 10 MFZ362 362GTZ	Je nach Kundenwunsch mit unterschiedlicher Kupplung / Equipped with different clutch according to customer requirement	(33)
	01.93 -		 3182 005 231	HHISZ-3	Füllmedium: Bremsflüssigkeit / Fill Medium: Brake Fluid Immer erneuern / Renew everytime	(23) (28)
	01.93 -		 3400 710 001 ⊗ 3482 120 031 ⊗ 1878 044 631 ⊗ 3182 005 231	362 10 MFZ362 362GTZ HHISZ-3		
7.103 L20 L33	04.96 -	D0824FL	 3400 121 801 ◐ ⊗ 3482 120 031 ⊗ 1878 044 631	362 10 MFZ362 362GTZ		
			 3400 710 001 ⊗ 3482 120 031 ⊗ 1878 044 631 ⊗ 3182 005 231	362 10 MFZ362 362GTZ HHISZ-3		
			 3182 005 231	HHISZ-3	Füllmedium: Bremsflüssigkeit / Fill Medium: Brake Fluid Immer erneuern / Renew everytime	(23) (28)
8.. - 12..		D0834LFL	 3400 700 303 ◐ ⊗ 3482 000 461 ⊗ 1878 079 331	362 10 MF362 362WGTZ	Getr. / GBox: S 5-42; 6S 850	
			 3400 710 002 ⊗ 3482 000 461 ⊗ 1878 079 331 ⊗ 3182 998 501	362 10 MF362 362WGTZ HHIS-3	Getr. / GBox: S 5-42; 6 S850	
			 3182 998 501	HHIS-3	Getr. / GBox: S 5-42; 6 S850 ohne Sensor / without sensor Füllmedium: Bremsflüssigkeit / Fill Medium: Brake Fluid Immer erneuern / Renew everytime	(104) (23) (28)
			 3400 121 701 ⊗ 3482 000 467 ⊗ 1862 506 131 ⊗ 3151 253 031	395 10 MFZ395 395WGTZ KZIZ-4,5	Getr. / GBox: FS 8309	
8.103 LC, 8.103 LLC L33 L20	10.93 - 06.96	D0824FL01	 3400 700 322 ◐ ⊗ 3482 093 032 ⊗ 1862 438 032	330 10 MFZ330 330WTB	-> 03.1996 L20,33 Je nach Kundenwunsch mit unterschiedlicher Kupplung / Equipped with different clutch according to customer requirement	(33)
			 3400 121 801 ◐ ⊗ 3482 120 031 ⊗ 1878 044 631	362 10 MFZ362 362GTZ	Je nach Kundenwunsch mit unterschiedlicher Kupplung / Equipped with different clutch according to customer requirement	(33)
			 3182 005 231	HHISZ-3	L20,33 Füllmedium: Bremsflüssigkeit / Fill Medium: Brake Fluid Immer erneuern / Renew everytime	(23) (28)
			 3400 710 001 ⊗ 3482 120 031 ⊗ 1878 044 631 ⊗ 3182 005 231	362 10 MFZ362 362GTZ HHISZ-3	L20,33	



























































		CODE				
--	--	------	--	---	---	---

MAN

L 2000		10.93 -					
8.103 LK L20	10.93 - 06.96	D0824FL01	 3400 700 322 ☉ ⊗ 3482 093 032 ⊗ 1862 438 032	330 10 MFZ330 330WTB	->03.1996 L20 Je nach Kundenwunsch mit unterschiedlicher Kupplung / Equipped with different clutch according to customer requirement	(33)	
			 3400 121 801 ☉ ⊗ 3482 120 031 ⊗ 1878 044 631	362 10 MFZ362 362GTZ	L20 Je nach Kundenwunsch mit unterschiedlicher Kupplung / Equipped with different clutch according to customer requirement	(33)	
			 3400 710 001 ⊗ 3482 120 031 ⊗ 1878 044 631 ⚡ 3182 005 231	362 10 MFZ362 362GTZ HHISZ-3	L20		
			 3182 005 231	HHISZ-3	L20 Füllmedium: Bremsflüssigkeit / Fill Medium: Brake Fluid Immer erneuern / Renew everytime	(23) (28)	
8.113 LC, 8.113 LLC L20 L33	08.95 -	D0824LFL04	 3400 700 322 ☉ ⊗ 3482 093 032 ⊗ 1862 438 032	330 10 MFZ330 330WTB	->03.1996 L20,33 Je nach Kundenwunsch mit unterschiedlicher Kupplung / Equipped with different clutch according to customer requirement	(33)	
			 3400 121 801 ☉ ⊗ 3482 120 031 ⊗ 1878 044 631	362 10 MFZ362 362GTZ	L20,33 Je nach Kundenwunsch mit unterschiedlicher Kupplung / Equipped with different clutch according to customer requirement	(33)	
			 3182 005 231	HHISZ-3	L20,33 Füllmedium: Bremsflüssigkeit / Fill Medium: Brake Fluid Immer erneuern / Renew everytime	(23) (28)	
			 3400 710 001 ⊗ 3482 120 031 ⊗ 1878 044 631 ⚡ 3182 005 231	362 10 MFZ362 362GTZ HHISZ-3	L20,33		
8.113 LC, 8.113 LLC, LRC, LLRC, (LE110C) L33 L20 L20 L33	09.00 -	D0824LFL08	 3400 121 801 ☉ ⊗ 3482 120 031 ⊗ 1878 044 631	362 10 MFZ362 362GTZ	L20,33		
			 3400 710 001 ⊗ 3482 120 031 ⊗ 1878 044 631 ⚡ 3182 005 231	362 10 MFZ362 362GTZ HHISZ-3	L20,33		
			 3182 005 231	HHISZ-3	L20,33 Füllmedium: Bremsflüssigkeit / Fill Medium: Brake Fluid Immer erneuern / Renew everytime	(23) (28)	
8.113 LK, LRK, L-KI, LR-KI L20	08.95 -	D0824LFL04	 3400 700 322 ☉ ⊗ 3482 093 032 ⊗ 1862 438 032	330 10 MFZ330 330WTB	->03.1996 L20 Je nach Kundenwunsch mit unterschiedlicher Kupplung / Equipped with different clutch according to customer requirement	(33)	
			 3400 121 801 ☉ ⊗ 3482 120 031 ⊗ 1878 044 631	362 10 MFZ362 362GTZ	L20 Je nach Kundenwunsch mit unterschiedlicher Kupplung / Equipped with different clutch according to customer requirement	(33)	
			 3182 005 231	HHISZ-3	L20 Füllmedium: Bremsflüssigkeit / Fill Medium: Brake Fluid Immer erneuern / Renew everytime	(23) (28)	
			 3400 710 001 ⊗ 3482 120 031 ⊗ 1878 044 631 ⚡ 3182 005 231	362 10 MFZ362 362GTZ HHISZ-3	L20		
8.145 LC, 8.145 LLC, L-LF (LE140C) L33 L20 L20 L33 9.145 LC, 9.145 LLC, LRC, LLRC (LE140C) L20 L33 L33 L20	09.00 -	D0834LFL02	 3400 700 303 ☉ ⊗ 3482 000 461 ⊗ 1878 079 331	362 10 MF362 362WGTZ	L20,33		
	09.00 -		 3400 710 002 ⊗ 3482 000 461 ⊗ 1878 079 331 ⚡ 3182 998 501	362 10 MF362 362WGTZ HHIS-3	L20,33		
			 3182 998 501	HHIS-3	L20,33 ohne Sensor / without sensor Füllmedium: Bremsflüssigkeit / Fill Medium: Brake Fluid Immer erneuern / Renew everytime	(104) (23) (28)	

















		CODE				
--	--	------	--	---	---	---

MAN

L 2000		10.93 -					
8.145 LLS, LLRS (LE140C) L33	09.00 -	D0834LFL02	 3400 700 303   3482 000 461  1878 079 331	362 10 MF362 362WGTZ	L33		
			 3400 710 002   3482 000 461  1878 079 331  3182 998 501	362 10 MF362 362WGTZ HHIS-3	L33		
			 3182 998 501	HHIS-3	L33 ohne Sensor / without sensor Füllmedium: Bremsflüssigkeit / Fill Medium: Brake Fluid Immer erneuern / Renew everytime	(104) (23) (28)	
8.145 LRK, L-KI, LR-KILK (LE140C) L20	09.00 -	D0834LFL02	 3400 700 303   3482 000 461  1878 079 331	362 10 MF362 362WGTZ	L20		
9.145 LK, LRK, L-KI, LR-KI (LE140C) L20	09.00 -		 3400 710 002   3482 000 461  1878 079 331  3182 998 501	362 10 MF362 362WGTZ HHIS-3	L20		
			 3182 998 501	HHIS-3	L20 ohne Sensor / without sensor Füllmedium: Bremsflüssigkeit / Fill Medium: Brake Fluid Immer erneuern / Renew everytime	(104) (23) (28)	
8.150 FOC,8.150 FOCL L50 L51	02.95 -	D0824	 3400 700 322   3482 093 032  1862 438 032	330 10 MFZ330 330WTB	L50,51 Je nach Kundenwunsch mit unterschiedlicher Kupplung / Equipped with different clutch according to customer requirement	(33)	
			 3400 121 801   3482 120 031  1878 044 631	362 10 MFZ362 362GTZ	L50,51 Je nach Kundenwunsch mit unterschiedlicher Kupplung / Equipped with different clutch according to customer requirement	(33)	
			 3182 005 231	HHISZ-3	L50,51 Füllmedium: Bremsflüssigkeit / Fill Medium: Brake Fluid Immer erneuern / Renew everytime	(23) (28)	
			 3400 710 001   3482 120 031  1878 044 631  3182 005 231	362 10 MFZ362 362GTZ HHISZ-3	L50,51		
8.153 L20 L22 L33	04.96 -	D0826LFL	 3400 121 801   3482 120 031  1878 044 631	362 10 MFZ362 362GTZ			
			 3400 710 001   3482 120 031  1878 044 631  3182 005 231	362 10 MFZ362 362GTZ HHISZ-3			
			 3182 005 231	HHISZ-3	Füllmedium: Bremsflüssigkeit / Fill Medium: Brake Fluid Immer erneuern / Renew everytime	(23) (28)	
8.153 LAEC L22 8.153 LAEK L22	01.95 - 06.96	D0824LFL	 3400 700 322   3482 093 032  1862 438 032	330 10 MFZ330 330WTB	->03.1996 L22 Je nach Kundenwunsch mit unterschiedlicher Kupplung / Equipped with different clutch according to customer requirement	(33)	
	01.95 - 09.96		 3400 121 801   3482 120 031  1878 044 631	362 10 MFZ362 362GTZ	->03.1996 L22 Je nach Kundenwunsch mit unterschiedlicher Kupplung / Equipped with different clutch according to customer requirement	(33)	
			 3182 005 231	HHISZ-3	->03.1996 L22 Füllmedium: Bremsflüssigkeit / Fill Medium: Brake Fluid Immer erneuern / Renew everytime	(23) (28)	
			 3400 710 001   3482 120 031  1878 044 631  3182 005 231	362 10 MFZ362 362GTZ HHISZ-3	->03.1996 L22		





























		CODE				
--	--	------	--	---	---	---

MAN

L 2000		10.93 -					
8.153 LC,8.153 LLC L20 L33 9.153 LC,9.153 LLC L33 L20	10.93-07.97	D0824LFL01, 05	 3400 700 322 ☾ ⊗ 3482 093 032 ⊗ 1862 438 032	330 10 MFZ330 330WTB	->03.1996 L20,33 Je nach Kundenwunsch mit unterschiedlicher Kupplung / Equipped with different clutch according to customer requirement	(33)	
	10.93-06.96		 3400 121 801 ☾ ⊗ 3482 120 031 ⊗ 1878 044 631	362 10 MFZ362 362GTZ		L20,33 Je nach Kundenwunsch mit unterschiedlicher Kupplung / Equipped with different clutch according to customer requirement	(33)
			 3182 005 231	HHISZ-3		L20,33 Füllmedium: Bremsflüssigkeit / Fill Medium: Brake Fluid Immer erneuern / Renew everytime	(23) (28)
			 3400 710 001 ⊗ 3482 120 031 ⊗ 1878 044 631 ⚡ 3182 005 231	362 10 MFZ362 362GTZ HHISZ-3		L20,33	
8.153 LK L20 9.153 LK L20	10.93-07.97	D0824LFL01, 05	 3400 700 322 ☾ ⊗ 3482 093 032 ⊗ 1862 438 032	330 10 MFZ330 330WTB	->03.1996 L20 Je nach Kundenwunsch mit unterschiedlicher Kupplung / Equipped with different clutch according to customer requirement	(33)	
	10.93-06.96		 3400 121 801 ☾ ⊗ 3482 120 031 ⊗ 1878 044 631	362 10 MFZ362 362GTZ		L20 Je nach Kundenwunsch mit unterschiedlicher Kupplung / Equipped with different clutch according to customer requirement	(33)
			 3182 005 231	HHISZ-3		L20 Füllmedium: Bremsflüssigkeit / Fill Medium: Brake Fluid Immer erneuern / Renew everytime	(23) (28)
			 3400 710 001 ⊗ 3482 120 031 ⊗ 1878 044 631 ⚡ 3182 005 231	362 10 MFZ362 362GTZ HHISZ-3		L20	
8.153 LLS L33	10.93-06.96	D0824LFL01, 05	 3400 700 322 ☾ ⊗ 3482 093 032 ⊗ 1862 438 032	330 10 MFZ330 330WTB	->03.1996 L33 Je nach Kundenwunsch mit unterschiedlicher Kupplung / Equipped with different clutch according to customer requirement	(33)	
			 3400 121 801 ☾ ⊗ 3482 120 031 ⊗ 1878 044 631	362 10 MFZ362 362GTZ		L33 Je nach Kundenwunsch mit unterschiedlicher Kupplung / Equipped with different clutch according to customer requirement	(33)
			 3182 005 231	HHISZ-3		L33 Füllmedium: Bremsflüssigkeit / Fill Medium: Brake Fluid Immer erneuern / Renew everytime	(23) (28)
			 3400 710 001 ⊗ 3482 120 031 ⊗ 1878 044 631 ⚡ 3182 005 231	362 10 MFZ362 362GTZ HHISZ-3		L33	
8.160 L50 L51	01.94 -	D0824	 3400 700 322 ☾ ⊗ 3482 093 032 ⊗ 1862 438 032	330 10 MFZ330 330WTB	Je nach Kundenwunsch mit unterschiedlicher Kupplung / Equipped with different clutch according to customer requirement	(33)	
			 3400 121 801 ☾ ⊗ 3482 120 031 ⊗ 1878 044 631	362 10 MFZ362 362GTZ		Je nach Kundenwunsch mit unterschiedlicher Kupplung / Equipped with different clutch according to customer requirement	(33)
			 3182 005 231	HHISZ-3		Füllmedium: Bremsflüssigkeit / Fill Medium: Brake Fluid Immer erneuern / Renew everytime	(23) (28)
			 3400 710 001 ⊗ 3482 120 031 ⊗ 1878 044 631 ⚡ 3182 005 231	362 10 MFZ362 362GTZ HHISZ-3			



















		CODE				
--	--	------	--	---	---	---

MAN

L 2000		10.93 -					
8.163 LC, 8.163 LLC L20 L33 9.163 LC, 9.163 LLC, LRC, LLRC L20 L33	05.94 -	D0824LFL02, 06, 09	 3400 700 322  ⊗ 3482 093 032 ⊗ 1862 438 032	330 10 MFZ330 330WTB	->03.1996 L20,33 Je nach Kundenwunsch mit unterschiedlicher Kupplung / Equipped with different clutch according to customer requirement	(33)	
	05.94 -		 3400 121 801  ⊗ 3482 120 031 ⊗ 1878 044 631	362 10 MFZ362 362GTZ		L20,33 Je nach Kundenwunsch mit unterschiedlicher Kupplung / Equipped with different clutch according to customer requirement	(33)
			 3182 005 231	HHISZ-3		L20,33 Füllmedium: Bremsflüssigkeit / Fill Medium: Brake Fluid Immer erneuern / Renew everytime	(23) (28)
			 3400 710 001 ⊗ 3482 120 031 ⊗ 1878 044 631 🔧 3182 005 231	362 10 MFZ362 362GTZ HHISZ-3		L20,33	
8.163 LC, 8.163 LLC (LE160C) L20 L33 L20 L33	09.00 -	D0824LFL09	 3400 121 801  ⊗ 3482 120 031 ⊗ 1878 044 631	362 10 MFZ362 362GTZ	L20,33		
			 3400 710 001 ⊗ 3482 120 031 ⊗ 1878 044 631 🔧 3182 005 231	362 10 MFZ362 362GTZ HHISZ-3	L20,33		
			 3182 005 231	HHISZ-3	L20,33 Füllmedium: Bremsflüssigkeit / Fill Medium: Brake Fluid Immer erneuern / Renew everytime	(23) (28)	
8.163 LC, 8.163 LLC, LRC, LLRC, L-LF L33 L20	08.95 -	D0824LFL07	 3400 700 322  ⊗ 3482 093 032 ⊗ 1862 438 032	330 10 MFZ330 330WTB	->03.1996 L20,33 Je nach Kundenwunsch mit unterschiedlicher Kupplung / Equipped with different clutch according to customer requirement	(33)	
			 3400 121 801  ⊗ 3482 120 031 ⊗ 1878 044 631	362 10 MFZ362 362GTZ		L20,33 Je nach Kundenwunsch mit unterschiedlicher Kupplung / Equipped with different clutch according to customer requirement	(33)
			 3182 005 231	HHISZ-3		L20,33 Füllmedium: Bremsflüssigkeit / Fill Medium: Brake Fluid Immer erneuern / Renew everytime	(23) (28)
			 3400 710 001 ⊗ 3482 120 031 ⊗ 1878 044 631 🔧 3182 005 231	362 10 MFZ362 362GTZ HHISZ-3		L20,33	
8.163 LK, LRK, L-KI, LR-KI L20 9.163 LK, LRK, L-KI, LR-KI L20	05.94 -	D0824LFL02, 06, 09	 3400 700 322  ⊗ 3482 093 032 ⊗ 1862 438 032	330 10 MFZ330 330WTB	->03.1996 L20 Je nach Kundenwunsch mit unterschiedlicher Kupplung / Equipped with different clutch according to customer requirement	(33)	
	05.94 -		 3400 121 801  ⊗ 3482 120 031 ⊗ 1878 044 631	362 10 MFZ362 362GTZ		L20 Je nach Kundenwunsch mit unterschiedlicher Kupplung / Equipped with different clutch according to customer requirement	(33)
			 3182 005 231	HHISZ-3		L20 Füllmedium: Bremsflüssigkeit / Fill Medium: Brake Fluid Immer erneuern / Renew everytime	(23) (28)
			 3400 710 001 ⊗ 3482 120 031 ⊗ 1878 044 631 🔧 3182 005 231	362 10 MFZ362 362GTZ HHISZ-3		L20	
8.163 LLS, LLRS L33 9.163 LLS, LLRS L33	05.94 -	D0824LFL02, 06, 09	 3400 700 322  ⊗ 3482 093 032 ⊗ 1862 438 032	330 10 MFZ330 330WTB	->03.1996 L33 Je nach Kundenwunsch mit unterschiedlicher Kupplung / Equipped with different clutch according to customer requirement	(33)	
	05.94 -		 3400 121 801  ⊗ 3482 120 031 ⊗ 1878 044 631	362 10 MFZ362 362GTZ		L33 Je nach Kundenwunsch mit unterschiedlicher Kupplung / Equipped with different clutch according to customer requirement	(33)
			 3182 005 231	HHISZ-3		L33 Füllmedium: Bremsflüssigkeit / Fill Medium: Brake Fluid Immer erneuern / Renew everytime	(23) (28)
			 3400 710 001	362 10		L33	



















		CODE				
--	--	------	--	---	---	---

MAN

L 2000		10.93 -					
8.185 LAC, LAEC, LARC, LAERC, LA-LF, LAE-LF (LE180C) L22	09.00-	D0834LFL03, D0836LFL02, D0834LFL02		3400 700 303   3482 000 461  1878 079 331	362 10 MF362 362WGTZ		
	09.00-			3400 710 002  3482 000 461  1878 079 331  3182 998 501	362 10 MF362 362WGTZ HHIS-3		
	09.00-			3182 998 501	HHIS-3	ohne Sensor / without sensor Füllmedium: Bremsflüssigkeit / Fill Medium: Brake Fluid Immer erneuern / Renew everytime	(104) (23)
8.225 LAC, LAEC, LARC, LAERC (LE220C) L23	09.00-						
8.225 LAK, LAEK, LARK, LAERK (LE180C) L22	09.00-						
8.225 LLS, LLRS (LE220C) L34	09.00-						
9.225 LLS, LLRS (LE220C) L34	09.00-						
10.145 LC,10.145 LLC, LRC, LLRC (LE140C) L33 L24 L33 L20 L35 L20	09.00-						
10.145 LK, LRK, L-KI, LR-KI (LE140C) L24	09.00-						
10.145 LLS, LLRS (LE140C) L35	09.00-						
10.185 LAC, LAEC, LARC, LAERC, LA-LA, LAE-LF (LE180C) L26	09.00-						
10.185 LAK, LAEK, LARK, LAERK (LE180C) L26	09.00-						
10.185 LC,10.185 LLC, LRC, LLRC (LE180C) L35 L24 L35 L24	09.00-						
10.185 LK, LRK, L-KI, LR-KI (LE180C) L24	09.00-						
10.185 LLS, LLRS (LE180C) L35	09.00-						
10.225 LAC, LAEC, LARC, LAERC, LA-LF, LAE-LF (LE220C) L26 L27	09.00-						
10.225 LAK, LAEK, LARK, LAERK (LE220C) L27	09.00-						
10.225 LC, 10.225 LLC, LRC, LLRC (LE220C) L25 L36 L25 L36	09.00-						
10.225 LK, LRK, L-KI, LR-KI(LE220C) L25	09.00-						
10.225 LLS, LLRS (LE220C) L24 L36	09.00-						
12.185 LC, LLC (LE180C) L70 L72	09.99-						
12.225 LC, LLC (LE220C) L71 L72 L73	09.99-						
8.185 LC,8.185 LLC, LRC, LLRC, L-LF (LE180C) L33 L20 L20 L33	09.00-	D0834LFL03		3400 700 303   3482 000 461  1878 079 331	362 10 MF362 362WGTZ	L20,33	
	09.00-			3400 710 002  3482 000 461  1878 079 331  3182 998 501	362 10 MF362 362WGTZ HHIS-3	L20,33	
				3182 998 501	HHIS-3	L20,33 ohne Sensor / without sensor Füllmedium: Bremsflüssigkeit / Fill Medium: Brake Fluid	(104) (23)



















































		CODE			 Parameter		
--	--	------	--	--	---	---	---

MAN

L 2000		10.93 -					
8.185 LK, LRK, L-KI, LR-KI (LE180C) L20	09.00 -	D0834LFL03		3400 700 303 3482 000 461 1878 079 331	362 10 MF362 362WGTZ	L20	
9.185 LK, LRK, L-KI, LR-KI (LE180C) L20	09.00 -			3400 710 002 3482 000 461 1878 079 331 3182 998 501	362 10 MF362 362WGTZ HHIS-3	L20	
				3182 998 501	HHIS-3	L20 ohne Sensor / without sensor Füllmedium: Bremsflüssigkeit / Fill Medium: Brake Fluid Immer erneuern / Renew everytime	(104) (23) (28)
8.185 LLS, LLRS (LE180C) L33	09.00 -	D0834LFL03		3400 700 303 3482 000 461 1878 079 331	362 10 MF362 362WGTZ	L33	
9.185 LLS, LLRS (LE 180C) L33	09.00 -			3400 710 002 3482 000 461 1878 079 331 3182 998 501	362 10 MF362 362WGTZ HHIS-3	L33	
				3182 998 501	HHIS-3	L33 ohne Sensor / without sensor Füllmedium: Bremsflüssigkeit / Fill Medium: Brake Fluid Immer erneuern / Renew everytime	(104) (23) (28)
8.220 FOC,8.220 FOCL L52 L53	04.95 -	D0826		3482 060 132	350 MF350	L53	
10.220 FOC,10.220 FOCL L52 L53	02.95 -			1878 001 145	350 10 350WGTZ	L53	
				3151 199 001	KZIS-3	L53	
8.223 LAEC L23	01.95 - 06.96	D0826LFL		3482 060 132	350 MF350	L21,23,34	
8.224 LAC, LAEC, LARC, LAERC L23	01.95 -			1878 001 145	350 10 350WGTZ	L21,23,34	
8.224 LAK, LAEK, LARK, LAERK L23	01.95 -			3151 199 001	KZIS-3	L21,23,34	
8.224 LC,8.224 LLC, LRC, LLRC L21 L34	05.94 -						
8.224 LK, LRK, L-KI, LR-KI L21	05.94 -						
8.224 LLS, LLRS L34	05.94 -						
9.224 LC,9.224 LLC, LRC, LLRC L21 L34	05.94 -						
9.224 LK, LRK, L-KI, LR-KI L21	05.94 -						
9.224 LLS, LLRS L34	05.94 -						
8.223 LC,8.223 LLC L34 L21	10.93 - 06.96	D0826LFL		3400 125 501 3482 060 132 1878 001 077 3151 199 001	350 10 MF350 350GTZ KZIS-3	->02.1994 L34	
8.223 LK L21	10.93 - 06.96			3482 060 132	350 MF350	03.1994-> L23,34	
9.223 LC,9.223 LLC L34 L21	10.93 - 06.96			1878 001 145	350 10 350WGTZ	03.1994-> L23,34	
9.223 LK L21	10.93 - 06.96			3151 199 001	KZIS-3	03.1994-> L23,34	
		D0826LFL02, 06		3482 060 132	350 MF350	L21	
				1878 001 145	350 10 350WGTZ	L21	
				3151 199 001	KZIS-3	L21	













		CODE				
--	--	------	--	---	---	---





MAN

L 2000		10.93 -					
8.223 LLS L34 9.223 LLS L34	10.93 - 06.96	D0826LFL	 3400 125 501  3482 060 132  1878 001 077  3151 199 001	350 10 MF350 350GTZ KZIS-3	-> 02.1994 L21,34		
			 3482 060 132	350 MF350	03.1994-> L21,23,34		
			 1878 001 145	350 10 350WGTZ	03.1994-> L21,23,34		
			 3151 199 001	KZIS-3	03.1994-> L21,23,34		
8.224 L34 L21 9.224 L21 L34 10.224 L25,36	01.93 - 02.94	D0826LFL	 3400 125 501  3482 060 132  1878 001 077  3151 199 001	350 10 MF350 350GTZ KZIS-3			
	01.93 - 02.94						
	01.93 - 02.94						
8.225 LC,8.225 LLC, LRC, LLRC (LE220C) L34 L20 L21 L21 L34 8.225 LK, LRK, L-KI, LR-KI (LE220C) L21 9.145 LLS, LLRS (LE140C) L33 9.225 LK, LRK, L-KI, LR-KI (LE220C) L21	09.00 -	D0836LFL02	 3400 700 303   3482 000 461  1878 079 331	362 10 MF362 362WGTZ	L21		
	09.00 -		 3400 710 002  3482 000 461  1878 079 331  3182 998 501	362 10 MF362 362WGTZ HHIS-3	L21		
	09.00 -		 3182 998 501	HHIS-3	L21 ohne Sensor / without sensor Füllmedium: Bremsflüssigkeit / Fill Medium: Brake Fluid Immer erneuern / Renew everytime	(104) (23) (28)	
9.153 LLS L33	10.93 - 12.95	D0824LFL01, 05	 3400 700 322   3482 093 032  1862 438 032	330 10 MFZ330 330WTB	L33 Je nach Kundenwunsch mit unterschiedlicher Kupplung / Equipped with different clutch according to customer requirement	(33)	
			 3400 121 801   3482 120 031  1878 044 631	362 10 MFZ362 362GTZ	L33 Je nach Kundenwunsch mit unterschiedlicher Kupplung / Equipped with different clutch according to customer requirement	(33)	
			 3182 005 231	HHISZ-3	L33 Füllmedium: Bremsflüssigkeit / Fill Medium: Brake Fluid Immer erneuern / Renew everytime	(23) (28)	
			 3400 710 001  3482 120 031  1878 044 631  3182 005 231	362 10 MFZ362 362GTZ HHISZ-3	L33		
9.163 LC L20 9.163 LK L20	08.95 - 03.97	D0824LFL07	 3400 700 322   3482 093 032  1862 438 032	330 10 MFZ330 330WTB	-> 03.1996 L20 Je nach Kundenwunsch mit unterschiedlicher Kupplung / Equipped with different clutch according to customer requirement	(33)	
	08.95 - 03.97		 3400 121 801   3482 120 031  1878 044 631	362 10 MFZ362 362GTZ	L20 Je nach Kundenwunsch mit unterschiedlicher Kupplung / Equipped with different clutch according to customer requirement	(33)	
			 3182 005 231	HHISZ-3	L20 Füllmedium: Bremsflüssigkeit / Fill Medium: Brake Fluid Immer erneuern / Renew everytime	(23) (28)	
			 3400 710 001  3482 120 031  1878 044 631  3182 005 231	362 10 MFZ362 362GTZ HHISZ-3	L20		
9.225 LC,9.225 LLC, LRC, LLRC (LE220C) L34 L21 L21 L34	09.00 -	D0836LFL02	 3400 700 303   3482 000 461  1878 079 331	362 10 MF362 362WGTZ	L21		
			 3182 998 501	HHIS-3	L21 ohne Sensor / without sensor Füllmedium: Bremsflüssigkeit / Fill Medium: Brake Fluid Immer erneuern / Renew everytime	(104) (23) (28)	

		CODE		 Parameter		
--	--	------	--	---	---	---

















MAN

L 2000		10.93 -				
10.150 FOC L50 10.163 LC,10.163 LLC, LRC, LLRC (LE160C) L35 L24 L24 L35	02.95 - 01.96	D0824LFO, D0824LFL09	 3400 121 801 ◐ ⊗ 3482 120 031 ⊗ 1878 044 631	362 10 MFZ362 362GTZ	Je nach Kundenwunsch mit unterschiedlicher Kupplung / Equipped with different clutch according to customer requirement	(33)
	09.00 -		 3182 005 231	HHISZ-3	Füllmedium: Bremsflüssigkeit / Fill Medium: Brake Fluid Immer erneuern / Renew everytime	(23)
			 3400 710 001 ⊗ 3482 120 031 ⊗ 1878 044 631 ⊗ 3182 005 231	362 10 MFZ362 362GTZ HHISZ-3		
10.153 LAEK L26 10.153 LC,10.153 LLC L24 L35 10.153 LK L24 10.153 LLS L35 10.163 LAC, LAEC, LARC, LAERC L26 10.163 LAK, LAEK, LARK, LAERK L26 10.163 LC,10.163 LLC L24 L35 10.163 LK, LRK, L-KI, LR-KI L24 10.163 LLS, LLRS L35	10.93 - 06.96	D0824LFL	 3400 700 322 ◐ ⊗ 3482 093 032 ⊗ 1862 438 032	330 10 MFZ330 330WTB	->03.1996 L24,26,35 Je nach Kundenwunsch mit unterschiedlicher Kupplung / Equipped with different clutch according to customer requirement	(33)
	10.93 - 06.96		 3400 121 801 ◐ ⊗ 3482 120 031 ⊗ 1878 044 631	362 10 MFZ362 362GTZ	L24,26,35 Je nach Kundenwunsch mit unterschiedlicher Kupplung / Equipped with different clutch according to customer requirement	(33)
	10.93 - 06.96		 3182 005 231	HHISZ-3	L24,26,35 Füllmedium: Bremsflüssigkeit / Fill Medium: Brake Fluid Immer erneuern / Renew everytime	(23)
	05.94 -		 3400 710 001 ⊗ 3482 120 031 ⊗ 1878 044 631 ⊗ 3182 005 231	362 10 MFZ362 362GTZ HHISZ-3	L24,26,35	
	01.95 -					
	05.94 -					
10.223 LAEC L27 10.224 LAC, LAEC, LARC, LAERC L27 10.224 LAK, LAEK, LARK, LAERK L27 10.224 LC,10.224 LLC, LRC, LLRC L35 L36 L25 10.224 LK, LRK, L-KI, LR-KI L25 10.224 LLS, LLRS L36	01.95 - 06.96	D0826LFL	 3482 060 132	350 MF350	L25,27,36	
	01.95 -		 1878 001 145	350 10 350WGTZ	L25,27,36	
	01.95 -		 3151 199 001	KZIS-3	L25,27,36	
	05.94 -					
10.223 LC,10.223 LLC L25 L36 L35 10.223 LK L25 10.223 LLS L36 L35	10.93 - 06.96	D0826LFL	 3400 125 501 ⊗ 3482 060 132 ⊗ 1878 001 077 ⊗ 3151 199 001	350 10 MF350 350GTZ KZIS-3	->02.1994 L25,36	
	10.93 - 06.96		 1878 001 145	350 10 350WGTZ	03.1994-> L25,27,36	
	10.93 - 06.96					

MAN-BÜSSING						
400-SERIE 400 L 1 400-SERIE 415 L 1 H,HA,F 400-SERIE 420 HOC 500-SERIE 520 L 1 H,HA,F 600-SERIE 626 F,H,HA			 1880 083 132 #	280 G280		
			 1863 100 030	GR-3	mit Anlauftring / with thrust ring	(88)
400-SERIE 450 HALF 600-SERIE 635 FM Büssing Mowag SW II			 1880 092 415 #	310 G310		
			 1863 100 030	GR-3	mit Anlauftring / with thrust ring	(88)





























		CODE		 Parameter		
--	--	------	--	---	---	---

MAN

MAN-BÜSSING						
500-SERIE 515 L 1 600-SERIE 620 L 1 600-SERIE 630 L 1 A 700-SERIE 745 L 1 700-SERIE 750 L 1,L 13 Büssing MK,25,26				1861 034 147 #	350 10 350	
700-SERIE 770 L 1 1000-SERIE 1070 L 1,A,F 2000-SERIE 2170 L 1 D				1882 110 532 #	350 GF350	
				1878 001 074	350 10 350GTZ	->04.1972
				1878 005 367	350 10 350WGTZ	05.1972->
				1863 100 030	GR-3	mit Anlauftring / with thrust ring
700-SERIE 780 H,HA 1000-SERIE 1080 H 1000-SERIE 1580				1882 110 532 #	350 GF350	
				1878 001 074	350 10 350GTZ	->04.1972
				1878 005 367	350 10 350WGTZ	05.1972->
1000-SERIE 1580 DF,DH 2000-SERIE 2180 DH,DHA 1000-SERIE 1580 FN MA				1882 110 532 #	350 GF350	
				1882 110 542	350 GF350	
				1878 001 074	350 10 350GTZ	->04.1972
				1878 005 367	350 10 350WGTZ	05.1972->
BS 13 L 15L		U10D		1882 325 134	380 G380	
				1861 470 234	380 10 380GSZ	
Burglöwe K,L,S 10 126M36,T Burglöwe L 10 126M43,50 Burglöwe U,UK,US,UMK,UMW Büssing 8 RU 5 Büssing 11 RU 5HR Büssing 12 RU 5HR Büssing 4000 T,K Büssing 4500 T,U Büssing LS 5 TU Büssing LU,TU 5,10 Büssing LU,TU,LS,OLU 55				1880 092 415 #	310 G310	
				1861 600 033 #	310 10 310GTD	
				1863 100 030	GR-3	mit Anlauftring / with thrust ring
Burglöwe L09 110 M36				1861 600 033 #	310 10 310GTD	
Burglöwe U BS 11,L09				1880 092 415 #	310 G310	
				1861 600 033 #	310 10 310GTD	



































		CODE				
--	--	------	--	---	---	---

MAN

M 90		08.88 - 12.98				
12.152 F,12.152 FL M01 M02 12.152 FK M01 12.152 FS,12.152 FLS M01 M02	12.88 - 05.94	D0826F01, 02	 3482 008 141 #	310 MF310	M01,02 Je nach Kundenwunsch mit unterschiedlicher Kupplung / Equipped with different clutch according to customer requirement	(33)
	12.88 - 05.94		 1862 244 032	310 10 310GSB	M01,02	
	12.88 - 05.94		 3151 199 001	KZIS-3	M01,02	
			 3400 700 322	330 10 MFZ330 330WTB	M01,02 Je nach Kundenwunsch mit unterschiedlicher Kupplung / Equipped with different clutch according to customer requirement	(33)
			 3400 121 801	362 10 MFZ362 362GTZ	M01,02 Je nach Kundenwunsch mit unterschiedlicher Kupplung / Equipped with different clutch according to customer requirement	(33)
			 3482 093 032  1862 438 032			
			 3482 120 031  1878 044 631			
		 3182 005 231	HHISZ-3	M01,02 Füllmedium: Bremsflüssigkeit / Fill Medium: Brake Fluid Immer erneuern / Renew everytime	(23) (28)	
		 3400 710 001	362 10 MFZ362 362GTZ HHISZ-3	M01,02		
12.192 F,12.192 FL M01 M02 12.192 FA M07	07.90 - 06.96	D0826TF01, 05	 3400 125 501	350 10 MF350 350GTZ KZIS-3	M01,02,07 Je nach Kundenwunsch mit unterschiedlicher Kupplung / Equipped with different clutch according to customer requirement	(33)
	10.92 - 06.96		 3482 060 132  1878 001 077  3151 199 001			
			 3482 017 035	380 GMF380	M01,02,07 Je nach Kundenwunsch mit unterschiedlicher Kupplung / Equipped with different clutch according to customer requirement	(33)
			 3482 017 034	380 GMF380	M01,02,07 für Fahrzeuge mit Kupplungskraftverstärker / for vehicles with clutch booster	(72)
			 1878 001 152	380 10 380WGTZ	M01,02,07	
		 3151 000 395	KZIS-4	M01,02,07		
12.192 FAK M07 12.192 FK M01 12.192 FS,12.192 FLS M01 M02	10.92 - 06.96	D0826TF01, 05	 3400 125 501	350 10 MF350 350GTZ KZIS-3	M01,02,07 Je nach Kundenwunsch mit unterschiedlicher Kupplung / Equipped with different clutch according to customer requirement	(33)
	07.90 - 06.96		 3482 060 132  1878 001 077  3151 199 001			
	07.90 - 06.96	D0826LF02, 06	 3482 017 035	380 GMF380	M03,04	
			 1878 000 957	380 10 380GTZ	M03,04	
			 3151 000 395	KZIS-4	M03,04	
			 3482 017 034	380 GMF380	M03,04 für Fahrzeuge mit Kupplungskraftverstärker / for vehicles with clutch booster	(72)
			 1878 001 152	380 10 380WGTZ	M03,04 für Fahrzeuge mit Kupplungskraftverstärker / for vehicles with clutch booster	(72)
	 3151 000 395	KZIS-4	M03,04 für Fahrzeuge mit Kupplungskraftverstärker / for vehicles with clutch booster	(72)		





































		CODE				
--	--	------	--	---	---	---

MAN

M 90		08.88 - 12.98						
12.222 F,12.222 FL M01 M02	05.94 - 06.96	D0826LF13, D0824LF02, D0826LF11		3482 008 141 #	310 MF310	Je nach Kundenwunsch mit unterschiedlicher Kupplung / Equipped with different clutch according to customer requirement	(33)	
12.222 FA M07	05.94 - 06.96			1862 244 032	310 10 310GSB			
12.222 FAK M07	05.94 - 06.96			3151 199 001	KZIS-3			
12.222 FK M01	05.94 - 06.96			3400 700 322   3482 093 032  1862 438 032	330 10 MFZ330 330WTB	Je nach Kundenwunsch mit unterschiedlicher Kupplung / Equipped with different clutch according to customer requirement	(33)	
12.222 FLS M02	05.94 - 06.96			3182 005 231	HHISZ-3	nur in Verbindung mit / only in connection with: 3482 093 032 Füllmedium: Bremsflüssigkeit / Fill Medium: Brake Fluid Immer erneuern / Renew everytime	(101) (23) (28)	
12.262 F,12.262 FL M01 M02	08.95 - 06.96			3400 125 501  3482 060 132  1878 001 077  3151 199 001	350 10 MF350 350GTZ KZIS-3	Je nach Kundenwunsch mit unterschiedlicher Kupplung / Equipped with different clutch according to customer requirement	(33)	
12.262 FS,12.262 FLS M02 M01	08.95 - 06.96			3482 017 035	380 GMF380	Je nach Kundenwunsch mit unterschiedlicher Kupplung / Equipped with different clutch according to customer requirement	(33)	
14.162 F,14.162 FL M03 M04	08.95 - 06.96			1878 000 957	380 10 380GTZ			
14.162 FK M03	08.95 - 06.96			3151 000 395	KZIS-4			
14.162 FS,14.162 FLS M04 M03	08.95 - 06.96			3482 017 034	380 GMF380	für Fahrzeuge mit Kupplungskraftverstärker / for vehicles with clutch booster	(72)	
14.222 F,14.222 FL M04 M03	05.94 - 06.96			1878 001 152	380 10 380WGTZ	für Fahrzeuge mit Kupplungskraftverstärker / for vehicles with clutch booster	(72)	
14.222 FK M03	05.94 - 06.96			3151 000 395	KZIS-4	für Fahrzeuge mit Kupplungskraftverstärker / for vehicles with clutch booster	(72)	
14.222 FLS M04	05.94 - 06.96							
14.262 F,14.262 FL M04 M03	08.95 - 06.96							
14.262 FK M03	08.95 - 06.96							
14.262 FS,14.262 FLS M03 M04	08.95 - 06.96							
12.232 F,12.232 FL M02 M01	08.88 - 06.96		D0826LF02, 06		3482 017 035	380 GMF380	M01,02,07	
12.232 FA M07	05.90 - 06.96				1878 000 957	380 10 380GTZ	M01,02,07	
12.232 FAK M07	05.90 - 06.96				3151 000 395	KZIS-4	M01,02,07	
12.232 FK M01	08.88 - 06.96			3482 017 034	380 GMF380	M01,02,07 für Fahrzeuge mit Kupplungskraftverstärker / for vehicles with clutch booster	(72)	
12.232 FS,12.232 FLS M02 M01	08.88 - 06.96			1878 001 152	380 10 380WGTZ	M01,02,07 für Fahrzeuge mit Kupplungskraftverstärker / for vehicles with clutch booster	(72)	
				3151 000 395	KZIS-4	M01,02,07 für Fahrzeuge mit Kupplungskraftverstärker / for vehicles with clutch booster	(72)	
12.272 F,12.272 FL M01 M02	10.92 - 06.96	D0826LF04		3482 017 035	380 GMF380	M01,02		
12.272 FS,12.272 FLS M02 M01	10.92 - 06.96			1878 000 957	380 10 380GTZ	M01,02		
				3151 000 395	KZIS-4	M01,02		
				3482 017 034	380 GMF380	M01,02 für Fahrzeuge mit Kupplungskraftverstärker / for vehicles with clutch booster	(72)	
				1878 001 152	380 10 380WGTZ	M01,02 für Fahrzeuge mit Kupplungskraftverstärker / for vehicles with clutch booster	(72)	
				3151 000 395	KZIS-4	M01,02 für Fahrzeuge mit Kupplungskraftverstärker / for vehicles with clutch booster	(72)	































		CODE				
--	--	------	--	---	---	---

























MAN

M 90		08.88 - 12.98					
12.272 F,12.272 FL M02 M01 12.272 FA M07 12.272 FAK M07 12.272 FK M01 12.272 FS,12.272 FLS M01 M02 14.272 F,14.272 FL M04 M03 14.272 FK M03 14.272 FS,14.272 FLS M04 M03	09.91 - 10.92	D2865LF02, D0826LF04	 3482 017 035	380 GMF380			
	10.93 - 04.95		 1878 001 152	380 10 380WGTZ			
	10.93 - 04.95		 3151 000 395	KZIS-4			
	09.91 - 10.92		 3482 017 034	380 GMF380	für Fahrzeuge mit Kupplungskraftverstärker / for vehicles with clutch booster	(72)	
	09.91 - 10.92		 1878 000 957	380 10 380GTZ	für Fahrzeuge mit Kupplungskraftverstärker / for vehicles with clutch booster	(72)	
	09.91 - 10.92		 3151 000 395	KZIS-4	für Fahrzeuge mit Kupplungskraftverstärker / for vehicles with clutch booster	(72)	
	09.91 - 10.92						
12.272 FK M01 15.272 M03,04	10.92 - 06.96	D0826LF04	 3482 017 035	380 GMF380			
	01.91 -		 1878 000 957	380 10 380GTZ			
			 3151 000 395	KZIS-4			
			 3482 017 034	380 GMF380	für Fahrzeuge mit Kupplungskraftverstärker / for vehicles with clutch booster	(72)	
			 1878 001 152	380 10 380WGTZ	für Fahrzeuge mit Kupplungskraftverstärker / for vehicles with clutch booster	(72)	
			 3151 000 395	KZIS-4	für Fahrzeuge mit Kupplungskraftverstärker / for vehicles with clutch booster	(72)	
13.152 M01,02	01.88 -	D0826F01, 02	 3482 008 141 #	310 MF310	Je nach Kundenwunsch mit unterschiedlicher Kupplung / Equipped with different clutch according to customer requirement	(33)	
			 1862 244 032	310 10 310GSB			
			 3151 199 001	KZIS-3			
			 3400 700 322 ☹  3482 093 032  1862 438 032	330 10 MFZ330 330WTB	Je nach Kundenwunsch mit unterschiedlicher Kupplung / Equipped with different clutch according to customer requirement	(33)	
			 3400 121 801 ☹  3482 120 031  1878 044 631	362 10 MFZ362 362GTZ	Je nach Kundenwunsch mit unterschiedlicher Kupplung / Equipped with different clutch according to customer requirement	(33)	
			 3182 005 231	HHISZ-3	Füllmedium: Bremsflüssigkeit / Fill Medium: Brake Fluid Immer erneuern / Renew everytime	(23) (28)	
			 3400 710 001  3482 120 031  1878 044 631  3182 005 231	362 10 MFZ362 362GTZ HHISZ-3			
13.192 M01,02 15.192 M03,04	01.88 -	D0826TF01, 05	 3400 125 501  3482 060 132  1878 001 077  3151 199 001	350 10 MF350 350GTZ KZIS-3	Je nach Kundenwunsch mit unterschiedlicher Kupplung / Equipped with different clutch according to customer requirement	(33)	
	01.88 -		 3482 017 035	380 GMF380	Je nach Kundenwunsch mit unterschiedlicher Kupplung / Equipped with different clutch according to customer requirement	(33)	
			 1878 000 957	380 10 380GTZ			
			 3151 000 395	KZIS-4			
			 3482 017 034	380 GMF380	für Fahrzeuge mit Kupplungskraftverstärker / for vehicles with clutch booster	(72)	
			 1878 001 152	380 10 380WGTZ	für Fahrzeuge mit Kupplungskraftverstärker / for vehicles with clutch booster	(72)	
			 3151 000 395	KZIS-4	für Fahrzeuge mit Kupplungskraftverstärker / for vehicles with clutch booster	(72)	

		CODE				
--	--	------	--	---	---	---



































MAN

M 90		08.88 - 12.98					
13.232 M01,02 13.272 M01,02 15.232 M03,04	01.88 -	D0826LF02, 06	 3482 017 035	380 GMF380			
	01.91 -		 1878 000 957	380 10 380GTZ			
	01.88 -		 3151 000 395	KZIS-4			
			 3482 017 034	380 GMF380	für Fahrzeuge mit Kupplungskraftverstärker / for vehicles with clutch booster	(72)	
			 1878 001 152	380 10 380WGTZ	für Fahrzeuge mit Kupplungskraftverstärker / for vehicles with clutch booster	(72)	
			 3151 000 395	KZIS-4	für Fahrzeuge mit Kupplungskraftverstärker / for vehicles with clutch booster	(72)	
14.152 F,14.152 FL M03 M04 14.152 FK M03 14.152 FS,14.152 FLS M04 M03	12.88 - 04.94	D0826F01, 02	 3482 008 141 #	310 MF310	M03,04 Je nach Kundenwunsch mit unterschiedlicher Kupplung / Equipped with different clutch according to customer requirement	(33)	
	12.88 - 05.94		 1862 244 032	310 10 310GSB	M03,04		
	12.88 - 05.94		 3151 199 001	KZIS-3	M03,04		
			 3400 700 322	330 10 MFZ330 330WTB	M03,04 Je nach Kundenwunsch mit unterschiedlicher Kupplung / Equipped with different clutch according to customer requirement	(33)	
			 3400 121 801	362 10 MFZ362 362GTZ	M03,04 Je nach Kundenwunsch mit unterschiedlicher Kupplung / Equipped with different clutch according to customer requirement	(33)	
			 3482 093 032  1862 438 032				
			 3482 120 031  1878 044 631				
			 3182 005 231	HHISZ-3	M03,04 Füllmedium: Bremsflüssigkeit / Fill Medium: Brake Fluid Immer erneuern / Renew everytime	(23) (28)	
14.152 F,14.152 FL M04 M03 14.152 FK M03 14.152 FS,14.152 FLS M03 M04	05.94 - 06.96	D0824LF01	 3482 008 141 #	310 MF310	Je nach Kundenwunsch mit unterschiedlicher Kupplung / Equipped with different clutch according to customer requirement	(33)	
	05.94 - 06.96		 1862 244 032	310 10 310GSB			
	05.94 - 06.96		 3151 199 001	KZIS-3			
			 3400 700 322	330 10 MFZ330 330WTB	Je nach Kundenwunsch mit unterschiedlicher Kupplung / Equipped with different clutch according to customer requirement	(33)	
			 3182 005 231	HHISZ-3	nur in Verbindung mit / only in connection with: 3482 093 032 Füllmedium: Bremsflüssigkeit / Fill Medium: Brake Fluid Immer erneuern / Renew everytime	(101) (23) (28)	
14.192 F,14.192 FL M04 M03 14.192 FS,14.192 FLS M03 M04	08.88 - 06.90	D0826TF	 3400 125 501	350 10 MF350 350GTZ KZIS-3			
	08.88 - 06.90		 3482 060 132  1878 001 077  3151 199 001				
		 3400 125 501	350 10 MF350 350GTZ KZIS-3	M03,04 Je nach Kundenwunsch mit unterschiedlicher Kupplung / Equipped with different clutch according to customer requirement	(33)		
		 3482 017 035	380 GMF380	M03,04 Je nach Kundenwunsch mit unterschiedlicher Kupplung / Equipped with different clutch according to customer requirement	(33)		
		 3482 017 034	380 GMF380	M03,04 für Fahrzeuge mit Kupplungskraftverstärker / for vehicles with clutch booster	(72)		
		 1878 001 152	380 10 380WGTZ	M03,04			
		 3151 000 395	KZIS-4	M03,04			

M 90		08.88 - 12.98					
14.192 F,14.192 FL M04 M03	07.90 - 06.96	D0826LF13, D0826LF01, D0826LF05, D0826LF07, D0826LF11	 3400 125 501 ⊗ 3482 060 132 ⊗ 1878 001 077 ⊙ 3151 199 001	350 10 MF350 350GTZ KZIS-3	Je nach Kundenwunsch mit unterschiedlicher Kupplung / Equipped with different clutch according to customer requirement	(33)	
14.192 FK M03	07.90 - 06.96		 3482 017 035	380 GMF380	Je nach Kundenwunsch mit unterschiedlicher Kupplung / Equipped with different clutch according to customer requirement	(33)	
14.192 FS,14.192 FLS M03 M04	07.90 - 06.96		 1878 000 957	380 10 380GTZ			
17.222 FA M08	05.94 - 06.96		 3482 017 034	380 GMF380	für Fahrzeuge mit Kupplungskraftverstärker / for vehicles with clutch booster	(72)	
17.222 FAK M08	05.94 - 06.96		 1878 001 152	380 10 380WGTZ			
18.222 F,18.222 FL,18.222 FLL M06 M05 M16	05.94 - 06.96		 3151 000 395	KZIS-4			
18.222 FK M05	05.94 - 06.96						
18.262 F,18.262 FL,18.262 FLL M05 M06 M16	08.95 - 06.96						
18.262 FK M05	08.95 - 06.96						
24.222 FNL,24.222 FNLL,24.222 FVL M10 M09 M19	05.94 - 06.96						
24.262 FNL,24.262 FNLL,24.262 FVL M09 M10 M19	08.95 - 06.96						
14.192 FK M03	08.88 - 06.90	D0826TF	 1863 869 038				
			 3400 125 501 ⊗ 3482 060 132 ⊗ 1878 001 077 ⊙ 3151 199 001	350 10 MF350 350GTZ KZIS-3			
14.232 F,14.232 FL M03 M04	05.90 - 04.95	D0826LF02, 06	 3482 017 035	380 GMF380	M03,04		
14.232 F,14.232 FL M04 M03	08.88 - 06.96		 1878 000 957	380 10 380GTZ	M03,04		
14.232 FK M03	08.88 - 06.96		 3482 017 034	380 GMF380	M03,04 für Fahrzeuge mit Kupplungskraftverstärker / for vehicles with clutch booster	(72)	
14.232 FS,14.232 FLS M04 M03	05.90 - 04.95		 1878 001 152	380 10 380WGTZ	M03,04		
14.232 FS,14.232 FLS M03 M04	08.88 - 06.96		 3151 000 395	KZIS-4	M03,04		
14.272 F,14.272 FL M04 M03	10.92 - 06.96	D0826LF04	 3482 017 035	380 GMF380	M03,04		
14.272 FK M03	10.92 - 06.96		 1878 000 957	380 10 380GTZ	M03,04		
14.272 FS,14.272 FLS M04 M03	12.92 - 06.96		 3482 017 034	380 GMF380	M03,04 für Fahrzeuge mit Kupplungskraftverstärker / for vehicles with clutch booster	(72)	
			 1878 001 152	380 10 380WGTZ	M03,04		
			 3151 000 395	KZIS-4	M03,04		
17.192 F,17.192 FL M06 M05	08.88 - 06.90	D0826TF, D2865LF02	 3400 125 501 ⊗ 3482 060 132 ⊗ 1878 001 077 ⊙ 3151 199 001	350 10 MF350 350GTZ KZIS-3	Je nach Kundenwunsch mit unterschiedlicher Kupplung / Equipped with different clutch according to customer requirement	(33)	
17.192 FA M08	02.89 - 06.90		 3482 017 035	380 GMF380	Je nach Kundenwunsch mit unterschiedlicher Kupplung / Equipped with different clutch according to customer requirement	(33)	
17.192 FAK M08	02.89 - 06.90		 1878 000 957	380 10 380GTZ			
17.192 FK M05	08.88 - 06.90		 3482 017 034	380 GMF380	für Fahrzeuge mit Kupplungskraftverstärker / for vehicles with clutch booster	(72)	
17.192 FS,17.192 FLS M05 M06	08.88 - 06.90		 1878 001 152	380 10 380WGTZ			
17.272 FLS M06	09.91 - 05.95		 3151 000 395	KZIS-4			
18.272 F,18.272 FL,18.272 FLL M05 M16 M06	09.91 - 05.94		 1878 000 964	380 10 380GTZ	für Nebenantrieb / for PTO	(82)	
18.272 FK M05	09.91 - 05.94						







































		CODE		 Parameter		
--	--	------	--	---	---	---

MAN

M 90		08.88 - 12.98				
17.192 F,17.192 FL M06 M05 17.192 FA M08 17.192 FAK M08 17.192 FK M05 17.192 FS,17.192 FLS M06 M05	07.90 - 04.95	D0826LF01, 05	 3400 125 501  3482 060 132  1878 001 077  3151 199 001	350 10 MF350 350GTZ KZIS-3	M05,06,08 Je nach Kundenwunsch mit unterschiedlicher Kupplung / Equipped with different clutch according to customer requirement	(33)
	07.90 - 06.96		 3482 017 035	380 GMF380	M05,06,08 Je nach Kundenwunsch mit unterschiedlicher Kupplung / Equipped with different clutch according to customer requirement	(33)
	07.90 - 06.96		 1878 000 957	380 10 380GTZ	M05,06,08	
	07.90 - 01.91		 3482 017 034	380 GMF380	M05,06,08 für Fahrzeuge mit Kupplungskraftverstärker / for vehicles with clutch booster	(72)
	07.90 - 04.95		 1878 001 152	380 10 380WGTZ	M05,06,08	
			 3151 000 395	KZIS-4	M05,06,08	
			 3400 700 412  3482 017 034  1878 000 964  3151 000 395	380 10 GMF380 380GTZ KZIS-4	M05,06,08 für Fahrzeuge mit Kupplungskraftverstärker / for vehicles with clutch booster	(72)
			 1878 000 964	380 10 380GTZ	für Nebenantrieb / for PTO	(82)
17.232 F,17.232 FL M05 M06 17.232 F,17.232 FL M06 M05 17.232 FA M08 17.232 FA M08 17.232 FAK M08 17.232 FAK M08 17.232 FK M05 17.232 FK M05 17.232 FS,17.232 FLS M05 M06 17.232 FS,17.232 FLS M06 M05	05.90 - 04.95	D0826LF02, 06	 3482 017 035	380 GMF380	M05,06,08	
	08.88 - 04.95		 1878 000 957	380 10 380GTZ	M05,06,08	
	05.90 - 04.95		 3482 017 034	380 GMF380	M05,06,08 für Fahrzeuge mit Kupplungskraftverstärker / for vehicles with clutch booster	(72)
	02.89 - 06.96		 1878 001 152	380 10 380WGTZ	M05,06,08	
	05.90 - 04.95		 3151 000 395	KZIS-4	M05,06,08	
	02.89 - 06.96		 3400 700 412  3482 017 034  1878 000 964  3151 000 395	380 10 GMF380 380GTZ KZIS-4	M05,06,08 für Fahrzeuge mit Kupplungskraftverstärker / for vehicles with clutch booster	(72)
	05.90 - 01.91		 1878 000 964	380 10 380GTZ	für Nebenantrieb / for PTO	(82)
	08.88 - 01.91					
17.272 FLS M06 18.272 F,18.272 FL,18.272 FLL M16 M06 M05 18.272 FK M05	10.92 - 05.95	D0826LF04	 3482 017 035	380 GMF380	M05,06,16	
	10.92 - 06.96		 1878 000 957	380 10 380GTZ	M05,06,16	
	10.92 - 06.96		 3482 017 034	380 GMF380	M05,06,16 für Fahrzeuge mit Kupplungskraftverstärker / for vehicles with clutch booster	(72)
			 1878 001 152	380 10 380WGTZ	M05,06,16	
			 3151 000 395	KZIS-4	M05,06,16	
			 3400 700 412  3482 017 034  1878 000 964  3151 000 395	380 10 GMF380 380GTZ KZIS-4	M05,06,16 für Fahrzeuge mit Kupplungskraftverstärker / for vehicles with clutch booster	(72)
			 1878 000 964	380 10 380GTZ	für Nebenantrieb / for PTO	(82)





































		CODE				
--	--	------	--	---	---	---

MAN

M 90		08.88 - 12.98					
18.192 F,18.192 FL,18.192 FLL M06 M05 M16 18.192 FK M05	09.90 - 06.96	D0826LF01, 05	 3400 125 501  3482 060 132  1878 001 077  3151 199 001	350 10 MF350 350GTZ KZIS-3	M05,06,08,16 Je nach Kundenwunsch mit unterschiedlicher Kupplung / Equipped with different clutch according to customer requirement	(33)	
	09.90 - 06.96		 3482 017 035	380 GMF380	M05,06,08,16 Je nach Kundenwunsch mit unterschiedlicher Kupplung / Equipped with different clutch according to customer requirement	(33)	
			 3482 017 034	380 GMF380	M05,06,08,16 für Fahrzeuge mit Kupplungskraftverstärker / for vehicles with clutch booster	(72)	
			 1878 001 152	380 10 380WGTZ	M05,06,08,16		
			 3151 000 395	KZIS-4	M05,06,08,16		
			 3400 700 412  3482 017 034  1878 000 964  3151 000 395	380 10 GMF380 380GTZ KZIS-4	M05,06,08,16 für Fahrzeuge mit Kupplungskraftverstärker / for vehicles with clutch booster	(72)	
			D0826LF	 1878 000 964	380 10 380GTZ	für Nebenantrieb / for PTO	(82)
18.232 F,18.232 FL,18.232 FLL M05 M06 M16 18.232 FK M05	09.90 - 06.96	D0826LF	 3400 121 701  3482 000 467  1862 506 131  3151 253 031	395 10 MFZ395 395WGTZ KZIZ-4,5	X43		
	09.90 - 06.96		 1878 000 964	380 10 380GTZ	für Nebenantrieb / for PTO	(82)	
			D0826LF02, 06	 3482 017 035	380 GMF380	M05,06,08,16	
				 1878 000 957	380 10 380GTZ	M05,06,08,16	
				 3482 017 034	380 GMF380	M05,06,08,16 für Fahrzeuge mit Kupplungskraftverstärker / for vehicles with clutch booster	(72)
				 1878 001 152	380 10 380WGTZ	M05,06,08,16	
				 3151 000 395	KZIS-4	M05,06,08,16	
18.310		D2866LOH25	 3482 083 032	430 MFZ430	Getr. / GBox: ZF 6S85		
			 1878 061 841	430 10 430WGTZ	Getr. / GBox: ZF 6S85		
			 3151 000 034	KZISZ-5	Getr. / GBox: ZF 6S85		
18.350 18.400		D2866LOH26, D2866LOH23	 3400 122 201  3482 083 032  1878 004 832  3151 000 034	430 10 MFZ430 430WGTZ KZISZ-5	Getr. / GBox: ZF 8S180		
24.192 FNL,24.192 FNLL,24.192 FVL M09 M10 M19	07.89 - 06.96	D0826LF01, 05	 3400 125 501  3482 060 132  1878 001 077  3151 199 001	350 10 MF350 350GTZ KZIS-3	M09,10 Je nach Kundenwunsch mit unterschiedlicher Kupplung / Equipped with different clutch according to customer requirement	(33)	
			 3482 017 035	380 GMF380	M09,10 Je nach Kundenwunsch mit unterschiedlicher Kupplung / Equipped with different clutch according to customer requirement	(33)	
			 3482 017 034	380 GMF380	M09,10 für Fahrzeuge mit Kupplungskraftverstärker / for vehicles with clutch booster	(72)	
			 1878 001 152	380 10 380WGTZ	M09,10		
			 3151 000 395	KZIS-4	M09,10		











		CODE				
--	--	------	--	---	---	---

MAN

M 90		08.88 - 12.98				
24.232 FNL M09 24.232 FNL,24.232 FNLL,24.232 FVL M09 M10 M19	05.90 - 04.95	D0826LF02, 06	 3482 017 035	380 GMF380	M09,10	
	07.89 - 06.96		 1878 000 957	380 10 380GTZ	M09,10	
			 3482 017 034	380 GMF380	M09,10 für Fahrzeuge mit Kupplungskraftverstärker / for vehicles with clutch booster	(72)
			 1878 001 152	380 10 380WGTZ	M09,10	
			 3151 000 395	KZIS-4	M09,10	
24.272 FNL,24.272 FNLL,24.272 FVL M10 M09 M19	10.92 - 06.96	D0826LF04	 3482 017 035	380 GMF380	M09,10	
			 1878 000 957	380 10 380GTZ	M09,10	
			 3482 017 034	380 GMF380	M09,10 für Fahrzeuge mit Kupplungskraftverstärker / for vehicles with clutch booster	(72)
			 1878 001 152	380 10 380WGTZ	M09,10	
			 3151 000 395	KZIS-4	M09,10	
24.272 FNL,24.272 FVL M10 M09	09.91 - 05.94	D2865LF02, 04, 05	 3400 127 601	400 10 MFZ400	->06.1993 F20 Nabenprofil / Hub Profile: 2"-10N	(46)
			 3482 078 133	400WGVZ		
			 1862 364 031	KZISZ-5		
		D2865	 3400 122 301	430 10 MFZ430	07.1993-> F20	
			 3482 083 032	430WGTZ		
			 1878 080 034	KZISZ-5		
			 3151 000 034			
 1882 017 131	420 GF420XN	für Nebenantrieb / for PTO	(82)			
 1878 086 941	420 10 420WGTZ	für Nebenantrieb / for PTO	(82)			
 3151 204 001	KZI-6	für Nebenantrieb / for PTO mit Schmierrohranschluß / with lubricating pipe coupling	(82) (91)			
M 2000 L		08.95 -				
11.153 L72 11.163 L72 12.153 L72,74,76	- 03.96	D0824LFL	 3400 700 322	330 10 MFZ330	Je nach Kundenwunsch mit unterschiedlicher Kupplung / Equipped with different clutch according to customer requirement	(33)
	- 03.96		 3482 093 032	330WTB		
	- 03.96		 3400 121 801	362 10 MFZ362	Je nach Kundenwunsch mit unterschiedlicher Kupplung / Equipped with different clutch according to customer requirement	(33)
			 3482 120 031	362GTZ		
			 3182 005 231	HHISZ-3	Füllmedium: Bremsflüssigkeit / Fill Medium: Brake Fluid	(23)
			 3400 710 001	362 10 MFZ362	Immer erneuern / Renew everytime	(28)
			 3482 120 031	362 MFZ362		
			 1878 044 631	362 10 362GTZ		
			 3182 005 231	HHISZ-3	Füllmedium: Bremsflüssigkeit / Fill Medium: Brake Fluid	(23)
					Immer erneuern / Renew everytime	(28)
11.174 L72			 3482 120 031	362 MFZ362		
			 1878 044 631	362 10 362GTZ		
			 3182 005 231	HHISZ-3	Füllmedium: Bremsflüssigkeit / Fill Medium: Brake Fluid	(23)
					Immer erneuern / Renew everytime	(28)
11.223 L73 11.224 L73	01.96 -	D0826LF	 3400 121 701	395 10 MFZ395		
	01.96 -		 3482 000 467	395WGTZ		
			 1862 506 131	KZIZ-4,5		
			 3151 253 031			































		CODE				
--	--	------	--	---	---	---





MAN

M 2000 L		08.95 -								
12.163 LC, LLC, LRC, LLRC L70 L72	08.95-	D0824LFL	 3400 700 322 ☉ ⊗ 3482 093 032 ⊗ 1862 438 032	330 10 MFZ330 330WTB	->03.1996 L72,74,76 Je nach Kundenwunsch mit unterschiedlicher Kupplung / Equipped with different clutch according to customer requirement	(33)				
			 3400 121 801 ☉ ⊗ 3482 120 031 ⊗ 1878 044 631	362 10 MFZ362 362GTZ			L72,74,76 Je nach Kundenwunsch mit unterschiedlicher Kupplung / Equipped with different clutch according to customer requirement	(33)		
			 3182 005 231	HHISZ-3	L72,74,76 Füllmedium: Bremsflüssigkeit / Fill Medium: Brake Fluid	(23)				
			 3400 710 001 ⊗ 3482 120 031 ⊗ 1878 044 631 🔧 3182 005 231	362 10 MFZ362 362GTZ HHISZ-3	L72,74,76 Immer erneuern / Renew everytime	(28)				
			 3400 121 701 ⊗ 3482 000 467 ⊗ 1862 506 131 ⦿ 3151 253 031	395 10 MFZ395 395WGTZ KZIZ-4,5	04.1996-> T72,74,76 Je nach Kundenwunsch mit unterschiedlicher Kupplung / Equipped with different clutch according to customer requirement	(33)				
12.223 L73,75,77,79	01.96-	D0826LFL	 3400 121 701 ⊗ 3482 000 467 ⊗ 1862 506 131 ⦿ 3151 253 031	395 10 MFZ395 395WGTZ KZIZ-4,5						
12.263 L73,75,77,79	01.96-									
12.264 L73,75,77,79	01.96-									
13.223 L75,77,79,80	01.96-									
13.224 L75,77,79,80	01.96-									
13.263 L75,77,79,80	01.96-									
13.264 L75,77,79,80	01.96-									
13.283 L75,77,79,80	01.96-									
14.223 L75,77,79,80,86	01.96-									
14.263 L75,77,79,80,86	01.96-									
15.223 L82,84,86	01.96-									
15.263 L82,84,86	01.96-									
15.283 L82,84,86	01.96-									
18.223 L87,88,89,90	01.96-									
18.263 L87,88,89,90	01.96-									
18.283 L87,88,89,90	01.96-									
12.224 LC, LLC, LRC, LLRC L73 L71	08.95-	D0826LFL	 3400 121 701 ⊗ 3482 000 467 ⊗ 1862 506 131 ⦿ 3151 253 031	395 10 MFZ395 395WGTZ KZIZ-4,5	L73,75,77,79					
13.153 L74,76	-03.96	D0824L, LFL	 3400 700 322 ☉ ⊗ 3482 093 032 ⊗ 1862 438 032	330 10 MFZ330 330WTB	Je nach Kundenwunsch mit unterschiedlicher Kupplung / Equipped with different clutch according to customer requirement	(33)				
13.163 L74,76	-03.96						 3400 121 801 ☉ ⊗ 3482 120 031 ⊗ 1878 044 631	362 10 MFZ362 362GTZ	Je nach Kundenwunsch mit unterschiedlicher Kupplung / Equipped with different clutch according to customer requirement	(33)
14.153 L74,76,81,83	-03.96						 3182 005 231	HHISZ-3		
15.153 L81,83	-03.96						 3400 710 001 ⊗ 3482 120 031 ⊗ 1878 044 631 🔧 3182 005 231	362 10 MFZ362 362GTZ HHISZ-3	Immer erneuern / Renew everytime	(28)

		CODE				
--	--	------	--	---	---	---















MAN

M 2000 L		08.95 -				
14.. - 18..		D0836LF	 3400 121 701  3482 000 467  1862 506 131  3151 253 031 3400 700 302   3482 000 464  1862 506 131 3400 700 303   3482 000 461  1878 079 331	395 10 MFZ395 395WGTZ KZIZ-4,5 395 10 MF395 395WGTZ 362 10 MF362 362WGTZ	Getr. / GBox: FS 8309; 16 S109 Getr. / GBox: 6S 850, SAE 2 Getr. / GBox: 6S 850, SAE 3	
14.163 LC, LLC, LRC, LLRC L74 L76 14.163 LK, LRK L74	08.95 - 08.95 -	D0824L, LFL	 3400 700 322   3482 093 032  1862 438 032  3400 121 801   3482 120 031  1878 044 631  3182 005 231  3400 710 001  3482 120 031  1878 044 631  3182 005 231  3400 121 701  3482 000 467  1862 506 131  3151 253 031	330 10 MFZ330 330WTB 362 10 MFZ362 362GTZ HHISZ-3 362 10 MFZ362 362GTZ HHISZ-3 395 10 MFZ395 395WGTZ KZIZ-4,5	->03.1996 L74,76,81,83 Je nach Kundenwunsch mit unterschiedlicher Kupplung / Equipped with different clutch according to customer requirement (33) L74,76,81,83 Je nach Kundenwunsch mit unterschiedlicher Kupplung / Equipped with different clutch according to customer requirement (33) L74,76,81,83 Füllmedium: Bremsflüssigkeit / Fill Medium: Brake Fluid (23) Immer erneuern / Renew everytime (28) L74,76,81,83 04.1996-> T74,76,81,83 Je nach Kundenwunsch mit unterschiedlicher Kupplung / Equipped with different clutch according to customer requirement (33)	
14.224 LAC, LARC L80 14.224 LAK, LARK L80 14.224 LC, LLC, LLLC, LRC, LLRC, LLLRC L79 L75 L77 14.224 LK, LRK L75 14.263, 14.264 LAC, LARC L80 14.263, 14.264 LAK, LARK L80 14.263, 14.264 LC, LLC, LLLC, LRC, LLRC, LLLRC L77 L75 L79 14.263, 14.264 LK, LRK L75	08.95 - 08.95 - 08.95 - 08.95 - 08.95 - 08.95 - 08.95 - 08.95 - 08.95 -	D0826LFL	 3400 121 701  3482 000 467  1862 506 131  3151 253 031	395 10 MFZ395 395WGTZ KZIZ-4,5	L75,77,79,80,86	

M 2000 L		08.95 -				
14.284 LC, LLC, LLLC, LRC, LLRC, LLLRC L75J L77J L79J	10.98-	D0826LFL10, D0836LF01, D0836LFL01, D0836LFL02, D0836LFL05, D0826LFL03, D0836LFL03	 3400 121 701 ⊗ 3482 000 467 ⊗ 1862 506 131 ⊙ 3151 253 031	395 10 MFZ395 395WGTZ KZIZ-4,5		
14.284, 14.285, LAC, LARC L80J	06.98-					
14.284, 14.285, LAK, LARK L80J	06.98-					
14.284, 14.285, LA-LF L80J	06.98-					
14.284, 14.285, LK, LRK L75J	10.98-					
15.284 LC, LLC, LLLC, LRC, LLRC, LLLRC L82J L84J L86J	06.98-					
15.284 LK, LRK L82J	06.98-					
18.284 LAC, LARC L90J	06.98-					
18.284 LAK, LARK L90J	06.98-					
26.224 DL-HK 6x4/2 L95	02.99-					
26.224 DLR-HK 6x4/2 L95	02.99-					
26.225 DL-HK 6x4/2 L95	09.00-					
26.225 DLR-HK 6x4/2 L95	09.00-					
26.255 DL-HK 6x4/2 L95	09.00-					
26.255 DLR-HK 6x4/2 L95	09.00-					
26.284 DL-HK 6x4/2 L95	02.99-					
26.284 DLR-HK 6x4/2 L95	02.99-					
26.284 DL-TM 6x4/2 L95	02.99-					
26.285 DL-HK 6x4/2 L95	09.00-					
26.285 DLR-HK 6x4/2 L95	09.00-					
26.285 DL-TM 6x4/2 L95	09.00-					
15.163 LC, LLC, LRC L83 L81	08.95-	D0824L, LFL	 3400 700 322 ⊖ ⊗ 3482 093 032 ⊗ 1862 438 032	330 10 MFZ330 330WTB	->03.1996 L81,83 Je nach Kundenwunsch mit unterschiedlicher Kupplung / Equipped with different clutch according to customer requirement	(33)
15.163 LK, LRK L81	08.95-		 3400 121 801 ⊖ ⊗ 3482 120 031 ⊗ 1878 044 631	362 10 MFZ362 362GTZ	->03.1996 L81,83 Je nach Kundenwunsch mit unterschiedlicher Kupplung / Equipped with different clutch according to customer requirement	(33)
			 3182 005 231	HHISZ-3	->03.1996 L81,83 Füllmedium: Bremsflüssigkeit / Fill Medium: Brake Fluid Immer erneuern / Renew everytime	(23) (28)
			 3400 710 001 ⊗ 3482 120 031 ⊗ 1878 044 631 ⊙ 3182 005 231	362 10 MFZ362 362GTZ HHISZ-3	->03.1996 L81,83	



		CODE				
--	--	------	--	---	---	---





MAN

M 2000 L		08.95 -					
15.224 LC, LLC, LLLC, LRC, LLRC, LLLRC L86 L82 L84	08.95-	D0826LFL		3400 121 701 ⊗ 3482 000 467 ⊗ 1862 506 131 ⊙ 3151 253 031	395 10 MFZ395 395WGTZ KZIZ-4,5	L82,84,86	
15.224 LK, LRK L82	08.95-						
15.263, 15.264 LC, LLC, LLLC, LRC, LLRC, LLLRC L82 L84 L86	08.95-						
15.263, 15.264 LK, LRK L82	08.95-						
18.224, 18.225, LAC, LARC L90	08.95-	D0826LFL		3400 121 701 ⊗ 3482 000 467 ⊗ 1862 506 131 ⊙ 3151 253 031	395 10 MFZ395 395WGTZ KZIZ-4,5	L87,88,89,90	
18.224, 18.225, LAK, LARK L90	08.95-						
18.263, 18.264, LAC, LARC L90	08.95-						
18.263, 18.264, LAK, LARK L90	08.95-						
18.224, 18.225, LC, LLC, LLLC, LRC, LLRC, LLLRC L88 L87 L89	08.95-	D0826LFL10, D0836LFL02, D0826LFL03		3400 700 302  ⊗ 3482 000 464 ⊗ 1862 506 131	395 10 MF395 395WGTZ	->09.2002 Getr. / GBox: ZF 6S850 (SAE2)	
18.224, 18.225, LK, LLK, LRK, LLRK L88 L87	08.95-			3400 710 003 ⊗ 3482 000 464 ⊗ 1862 506 131 ⊙ 3182 998 501	395 10 MF395 395WGTZ HHIS-3	10.2002-> Getr. / GBox: ZF 6S850 (SAE2)	
				3182 998 501	HHIS-3	Getr. / GBox: ZF 6S850 (SAE2) ohne Sensor / without sensor Füllmedium: Bremsflüssigkeit / Fill Medium: Brake Fluid Immer erneuern / Renew everytime	(104) (23)
				3496 006 000		Getr. / GBox: ZF 6S850 (SAE2) langer Bügel / long handle	(28) (86)
				3400 121 701 ⊗ 3482 000 467 ⊗ 1862 506 131 ⊙ 3151 253 031	395 10 MFZ395 395WGTZ KZIZ-4,5	Getr. / GBox: Eaton	
				3496 006 000		Getr. / GBox: Eaton langer Bügel / long handle	(86)
				1878 000 964	380 10 380GTZ	Nebenantriebs-ID / PTO ID: NMV130E	(48)
				3151 204 001	KZI-6	mit Schmierrohranschluß / with lubricating pipe coupling Nebenantriebs-ID / PTO ID: NMV130E	(91) (48)
18.255 LC, LLC, LLLC, LRC, LLRC, LLLRC, (LE250B) L89 L88 L87	09.99-	D0836LFL01, D0826LFL09, D0836LFL05, D0836LFL03		3400 121 701 ⊗ 3482 000 467 ⊗ 1862 506 131 ⊙ 3151 253 031	395 10 MFZ395 395WGTZ KZIZ-4,5	Getr. / GBox: Eaton	
18.263, 18.264, LC, LLC, LLLC, LRC, LLRC, LLLRC L89 L87 L88	08.95-			1878 000 964	380 10 380GTZ	Nebenantriebs-ID / PTO ID: NMV130E	(48)
18.263, 18.264, LK, LLK, LRK, LLRK L88 L87	08.95-			3151 204 001	KZI-6	mit Schmierrohranschluß / with lubricating pipe coupling Nebenantriebs-ID / PTO ID: NMV130E	(91) (48)
18.284 LC, LLC, LLLC, LRC, LLRC, LLLRC L87J L88J L89J	06.98-						
18.284, 18.285, LK, LLK, LRK, LLRK L87J L88J	06.98-						
18.284, 18.285, L-KO, LR-KO L87J	06.98-						
18.285 LC, LLC, LLLC, LRC, LLRC, LLLRC, (LE280B) L89 L87 L88	09.99-						

		CODE				
--	--	------	--	---	---	---

MAN



M 2000 L		08.95 -				
26.224, 26.225, DL-HK, DLR-HK L95	11.02-		 3400 121 701 ⊗ 3482 000 467 ⊗ 1862 506 131 ⬢ 3151 253 031	395 10 MFZ395 395WGTZ KZIZ-4,5		
26.255 DL-HK, DLR-HK L95	11.02-		 1878 000 964	380 10 380GTZ	für Nebenantrieb / for PTO	(82)
26.284 DL-TM, DLR-TM L95	05.01-					
26.284, 26.285, DL-HK, DLR-HK L95	11.02-					

M 2000 M		08.95 - 12.05				
12.224 M32,33,34	08.95-	D0826LF	 3400 121 701 ⊗ 3482 000 467 ⊗ 1862 506 131 ⬢ 3151 253 031	395 10 MFZ395 395WGTZ KZIZ-4,5		
12.264 M32,33,34	08.95-					
13.224 M32,33,34	08.95-					
13.264 M32,33,34	08.95-					
13.283 M32,33,34	08.95-					
18.283 M38-41	03.95-					
23.224 M42,44	06.95-					
23.264 M42,44	06.95-					
23.283 M42,44	06.95-					
25.283 M42,44	06.95-					
25.283 M43	06.95-					
14.. - 18..		D0836LF	 3400 121 701 ⊗ 3482 000 467 ⊗ 1862 506 131 ⬢ 3151 253 031	395 10 MFZ395 395WGTZ KZIZ-4,5	Getr. / GBox: FS 8309; 16 S109	
			 3400 700 303 ⊗ 3482 000 461 ⊗ 1878 079 331	362 10 MF362 362WGTZ	Getr. / GBox: 6S 850, SAE 3	
			 3400 700 302 ⊗ 3482 000 464 ⊗ 1862 506 131	395 10 MF395 395WGTZ	Getr. / GBox: 6S 850, SAE 2	
14.224 MAK M34	08.95 - 12.05	D0826LF	 3400 121 701 ⊗ 3482 000 467 ⊗ 1862 506 131 ⬢ 3151 253 031	395 10 MFZ395 395WGTZ KZIZ-4,5	M32,33,34	
14.224 MC, MLC, MLLC M31 M32 M33	08.95 - 12.05					
14.224 MLS, MLRS M32	08.95 - 12.05					
14.264 MC, MLC, MLLC M32 M31 M33	08.95 - 12.05					
14.264 MLS, MLRS M32	08.95 - 12.05					



		CODE				
--	--	------	--	---	---	---

MAN

M 2000 M 08.95 - 12.05

14.284 MAK M34J	06.98 - 12.05	D0836LF01		3400 121 701 ⊗ 3482 000 467 ⊕ 1862 506 131 ◊ 3151 253 031	395 10 MFZ395 395WGTZ KZIZ-4,5		
14.284 MA-KO, MA-LF M34J	06.98 - 12.05						
14.284 MC, MLC, MLLC M33J M32J M31J	06.98 - 12.05						
14.284 MLS, MLRS M32J	06.98 - 12.05						
18.284 MAC, MARC M41J	06.98 - 12.05						
18.284 MAK, MARK M41J	06.98 - 12.05						
18.284 MC, MLC, MLLC, MRC, MLRC, LLRC M39J M38J M40J	06.98 - 12.05						
18.284 MK, 18.284 MLK, MRK, MLRK M39J M38J	06.98 - 12.05						
18.284 MLS, MLRS M39J	06.98 - 12.05						
18.224 MAC, MARC M41	08.95 - 12.05	D0826LF		3400 121 701 ⊗ 3482 000 467 ⊕ 1862 506 131 ◊ 3151 253 031	395 10 MFZ395 395WGTZ KZIZ-4,5	M38-41	
18.224 MAK, MARK M41	08.95 - 12.05						
18.224 MC, MLC, MLLC, MRC, MLRC, MLLRC M38 M40 M39	08.95 - 12.05						
18.224 MK, 18.224 MLK, MRK, MLRK M39 M38	08.95 - 12.05						
18.224 MLS, MLRS M39	08.95 - 12.05						
25.224 MNLC, MNLLC, MNLRC, MNLLRC, MVLC M42 M44 M43	08.95 - 12.05	D0826LF		3400 121 701 ⊗ 3482 000 467 ⊕ 1862 506 131 ◊ 3151 253 031	395 10 MFZ395 395WGTZ KZIZ-4,5	M42,44	
25.264 MNLC, MNLLC, MNLRC, MNLLRC, MVLC M42 M43 M44	08.95 - 12.05						

TGA 03.00 -

18.280 LL H04	02.01 - 08.01	D0836LF44, D0836LF41, D0836LF43		3400 121 701 ⊗ 3482 000 467 ⊕ 1862 506 131 ◊ 3151 253 031	395 10 MFZ395 395WGTZ KZIZ-4,5		
18.330 LL H04	02.01 - 08.01			3496 006 000		langer Bügel / long handle	(86)

		CODE				
--	--	------	--	---	---	---









MAN

TGA		03.00 -				
18.310 FAC, FARC H51	09.02-	D2866LF26, D2866LF27, D2866LF28, D2866LF37, D2866LF32		3400 127 401	430 10	
18.310 FAK, FAK-L, FALK H51 H70	09.02-			<ul style="list-style-type: none"> ⊗ 3482 000 361 ⊗ 1878 004 832 ⊙ 3151 000 034 	<ul style="list-style-type: none"> MFZ430 430WGTZ KZISZ-5 	
18.310 FAS, FARS H51	09.02-			3400 700 450	430 10	Getr. / GBox: AS-Tronic für Ausrückgabel mit Rollen / for release fork with rollers
18.360 FAC, FARC H51	09.02-			<ul style="list-style-type: none"> ⊗ 3482 000 361 ⊗ 1878 004 832 ⊙ 3151 000 493 	<ul style="list-style-type: none"> MFZ430 430WGTZ KZISZ-5 	
18.360 FAK, FALK, FAK-L, FALK-L H70 H51	09.02-			3400 700 403	430 10	Getr. / GBox: AS-Tronic für Ausrückgabel mit Nocken / for release fork with cams
18.360 FAS, FALS, FARS H51 H70	09.02-			<ul style="list-style-type: none"> ⊗ 3482 000 361 ⊗ 1878 004 832 ⊙ 3151 000 144 	<ul style="list-style-type: none"> MFZ430 430WGTZ KZISZ-5 	(69)
18.410 FAC, FARC H51	09.02-					
18.410, 18420 FAK, FAK-L, FALK H70 H51	09.02-					
18.410 FAS, FALS, FARS H51 H70	09.02-					
24.360 FNLLC/N, FNLLW, FNLLRW, FNLLRC H44	09.01-					
24.410 FNLLC/N, FNLLW, FNLLRW H44	09.01-					
26.310 FDAC, FDARC H55	02.02-					
26.310 FDAK H55	02.02-					
26.310 FDAS, FDARS H55	02.02-					
26.360 FDAC, FDARC H55	02.02-					
26.360 FDAK, FDALK H72 H55	02.02-					
26.360 FDAS, FDARS H55	02.02-					
26.410 FDAC, FDARC H55	02.02-					
26.410 FDAK, FDALK H72 H55	02.02-					
26.410 FDAS, FDALS, FDARS H55 H72	02.02-					
32.310 FFDC, FFDLC, FFDLRC H40 H36	01.02-					
32.310 FFDK, FFDLK H36 H40	01.02-					
32.310 FFD-TM H36	01.02-					
32.360 FFDC, FFDLC, FFDLRC H40 H36	01.02-					
32.360 FFDK, FFDLK H40 H36	01.02-					
32.410 FFDC, FFDLC, FFDRC, FFDLRC H40 H36	01.02-					
32.410 FFDK, FFDLK H40 H36	01.02-					
32.410 FFD-TM H36 H48	01.02-					
33.360 FDAC, FDARC, FDAC- WW H54 H55	09.02-					
33.360 FDAK, FDAK-WW H55 H54	09.02-					

		CODE				
--	--	------	--	---	---	---





































MAN

TGA		03.00 -					
33.360 FDAS, FDAS-WW H54 H55	09.02 -	D2866LF26, D2866LF27, D2866LF28, D2866LF37, D2866LF32		3400 127 401	430 10		
33.410 FDAC, FDAC-WW, FDALC H54 H72 H55	09.02 -			<ul style="list-style-type: none"> ⊗ 3482 000 361 ⊗ 1878 004 832 ◦ 3151 000 034 	<ul style="list-style-type: none"> MFZ430 430WGTZ KZISZ-5 		
33.410 FDAK, FDAK-WW, FDALK H54 H55 H72	09.02 -			<ul style="list-style-type: none"> ⊗ 3482 000 361 ⊗ 1878 004 832 ◦ 3151 000 493 	<ul style="list-style-type: none"> MFZ430 430WGTZ KZISZ-5 	Getr. / GBox: AS-Tronic für Ausrückgabel mit Rollen / for release fork with rollers	(70)
33.410 FDAS, FDAS-WW, FDALS H55 H54 H72	09.02 -			<ul style="list-style-type: none"> ⊗ 3482 000 361 ⊗ 1878 004 832 ◦ 3151 000 144 	<ul style="list-style-type: none"> MFZ430 430WGTZ KZISZ-5 	Getr. / GBox: AS-Tronic für Ausrückgabel mit Nocken / for release fork with cams	(69)
41.360 FFDC, FFDC/M, FFDC/M-WW, FFDCRC H46 HW3 H38	01.03 -						

TGA		03.00 -				
18.310, 18320 FC, FLC, FRC, FLLC, FLLC/N, FLLW, FLLRC, FLLRW H02 H09 H05 H14	04.00-	D2866LF27, D2866LF26, D2866LF28, D2866LF36, D2866LF37, D2866LF32	 3400 127 401 ⊗ 3482 000 361 ⊗ 1878 004 832 ⊙ 3151 000 034	430 10 MFZ430 430WGTZ KZISZ-5	Getr. / GBox: ZF Ecosplit-3	
18.310, 18320 FK, FLK, FK-L, FLRK H05 H02	12.00-		 3488 017 447	400 MFZ2/400X	Getr. / GBox: ZF Ecosplit-3 für Fahrzeuge mit Zweischeibenkupplung / for vehicles with double disc clutch enthält eine Kupplungsscheibe / This part number includes one clutch disc	(77) (66)
18.310 FLS, FLLS, FLLS/N, FLS-TS, FLRS, FLLRS H01 H12 H05 H09	04.00-		 1878 002 643	400 10 400WGTZ	Getr. / GBox: ZF Ecosplit-3 für Fahrzeuge mit Zweischeibenkupplung / for vehicles with double disc clutch	(77)
18.360 FC, FLC, FRC, FLLC, FLLC/N, FLLW, FLLRW H02 H05 H09 H14	04.00-		 3151 262 031	KZISZ-5	Getr. / GBox: ZF Ecosplit-3 für Fahrzeuge mit Zweischeibenkupplung / for vehicles with double disc clutch	(77)
18.360 FK, FLK, FK-L, FLRK H02 H05	12.00-		 3400 700 327 ⊗ 3482 114 031 ⊗ 1878 004 832 ⊙ 3151 263 031	430 10 GMFZ430N 430WGTZ KZIZ-6	Getr. / GBox: ZF 16S-151/181 für Fahrzeuge mit Nebenantrieb / for vehicles with PTO	(73)
18.360 FLS, FLLS, FLLS/N, FLS-TS, FLRS, FLLRS H12 H09 H61 H01 H05	04.00-		 3400 700 403 ⊗ 3482 000 361 ⊗ 1878 004 832 ⊙ 3151 000 144	430 10 MFZ430 430WGTZ KZISZ-5	Getr. / GBox: AS-Tronic für Ausrückgabel mit Nocken / for release fork with cams	(69)
18.410, 18420 FC, FRC, FLC, FLRC, FLLC, FLLC/N, FLLW, FLLRC H05 H09 H14 H02	04.00-		 3400 700 450 ⊗ 3482 000 361 ⊗ 1878 004 832 ⊙ 3151 000 493	430 10 MFZ430 430WGTZ KZISZ-5	Getr. / GBox: AS-Tronic für Ausrückgabel mit Rollen / for release fork with rollers	(70)
18.410, 18420 FK, FK-L, FLK, FLRK H05 H02	12.00-		 3496 006 000		langer Bügel / long handle	(86)
18.410 FLS, FLLS, FLLS/N, FLS-TS, FLRS, FLLRS H12 H05 H09 H61 H01	04.00-					
26.310 FDC, FDLC, FDRC, FDLC/M, FDLRC H25 H29	01.01-					
26.310 FDK, FDLK, FDRK H29 H25	09.02-					
26.310 FDS, FDLS, FDLS/M, FDLRS H25 H29	01.01-					
26.310 FD-TM, FDR-TM H25	10.00-					
26.310 FPLS, FVLS, FNLS, FNLLS, FPLRS, FNLRS, FVLR H23 H17 H20	12.00-					
26.310 FVL-KO H23	12.00-					
26.360 FDC, FDLC, FDLC/M, FDRC, FDLRC-WW H63 H67 H25 H29	01.01-					
26.360 FDK, FDLK, FDRK, FDLRK H29 H25	09.02-					
26.360 FDLS, FDLS/M, FDLRS, FDLRS/M, FDLRS-WW, FDRS H63 H67 H25 H29	09.03-					
26.360 FDS, FDLS, FNLS, FNLLS, FPLS, FPLRS, FVLS, FVLR H25 H23 H17 H20	12.00-					
26.360 FD-TM, FDR-TM H25	01.01-					
26.360 FVL-KO H23	12.00-					
26.410 FDC, FDLC, FDLC/M, FDLC-WW; FDRC-WW, FDLRC-WW H29 H63 H25	01.01-					
26.410 FDK, FDRK, FDLK, FDLRK H29 H25	09.01-					





















		CODE				
--	--	------	--	---	---	---

MAN

TGA		03.00 -						
26.410 FDS, FDLS, FDLS/M, FDLS-WW, FDRS-WW, FDLRS-WW H29 H63 H25 26.410 FD-TM, FDR-TM H25 26.410 FNLC, FNLLC, FNLLW, FNLR, FNLLRC, FVLC H20 H17 H23 26.410 FPLS, FPLRS, FVLS, FNLS, FNLLS H17 H23 H20 26.410 FVL-KO H23	06.01 -	D2866LF27, D2866LF26, D2866LF28, D2866LF36, D2866LF37, D2866LF32	 3400 127 401  3482 000 361  1878 004 832  3151 000 034	430 10 MFZ430 430WGTZ KZISZ-5	Getr. / GBox: ZF Ecosplit-3			
	01.01 -		 3488 017 447	400 MFZ2/400X	Getr. / GBox: ZF Ecosplit-3 für Fahrzeuge mit Zweischeibenkupplung / for vehicles with double disc clutch enthält eine Kupplungsscheibe / This part number includes one clutch disc	(77)		
	04.00 -		 1878 002 643	400 10 400WGTZ	Getr. / GBox: ZF Ecosplit-3 für Fahrzeuge mit Zweischeibenkupplung / for vehicles with double disc clutch	(77)		
	12.00 -		 3151 262 031	KZISZ-5	Getr. / GBox: ZF Ecosplit-3 für Fahrzeuge mit Zweischeibenkupplung / for vehicles with double disc clutch	(77)		
	12.00 -		 3400 700 327  3482 114 031  1878 004 832  3151 263 031	430 10 GMFZ430N 430WGTZ KZISZ-6	Getr. / GBox: ZF 16S-151/181 für Fahrzeuge mit Nebenantrieb / for vehicles with PTO	(73)		
			 3400 700 403  3482 000 361  1878 004 832  3151 000 144	430 10 MFZ430 430WGTZ KZISZ-5	Getr. / GBox: AS-Tronic für Ausrückgabel mit Nocken / for release fork with cams	(69)		
			 3400 700 450  3482 000 361  1878 004 832  3151 000 493	430 10 MFZ430 430WGTZ KZISZ-5	Getr. / GBox: AS-Tronic für Ausrückgabel mit Rollen / for release fork with rollers	(70)		
			 3496 006 000		langer Bügel / long handle	(86)		
	18.310, 18.320 FAC, FHLC H22 H52 18.310, 18.320 FAK, FAK-L, FALK, FALK-L, FHLK, FHLK/M H52 H80 H22 18.310, 18.320 FAS, FALS, FHLS, FHLS/M H80 H52 H22 18.350, 18.360 FAC, FHLC H22 H52 HV5 18.350, 18.360 FAK, FAK-L, FALK, FALK-L, FHLK, FHLK/M H52 H22 HV5 H80 18.350, 18.360 FAS, FALS, FHLS, FHLS/M HV5 H52 H80 H22 18.390, 18.400 FAC, FHLC HV5 H52 H22 18.390, 18.400 FAK, FAK-L, FALK, FALK-L, FHLK, FHLK/M H22 H52 H80 HV5 18.390, 18.400 FAS, FALS, FHLS, FHLS/M H22 H52 H80 HV5		05.04 -	D2066LF37, D2066LF39, D2066LF03, D2066LF02, D2066LF33, D2066LF35, D2066LF12, D2066LF14, D2066LF32, D2066LF13, D2066LF04, D2066LF38	 3400 700 380  3482 000 361  1878 080 037  3151 000 034	430 10 MFZ430 430WGTZ KZISZ-5	Getr. / GBox: ZF Ecosplit-3 H22	
			05.04 -		 3482 000 361	430 MFZ430	Getr. / GBox: AS-Tronic H22	
05.04 -		 1878 080 037	430 10 430WGTZ		Getr. / GBox: AS-Tronic H22			
05.04 -		 3151 000 144	KZISZ-5		Getr. / GBox: AS-Tronic H22 für Ausrückgabel mit Nocken / for release fork with cams	(69)		
05.04 -		 3400 700 381  3482 000 361  1878 080 037  3151 000 493	430 10 MFZ430 430WGTZ KZISZ-5		Getr. / GBox: AS-Tronic H22 für Ausrückgabel mit Rollen / for release fork with rollers	(70)		
05.04 -		 3400 700 327  3482 114 031  1878 004 832  3151 263 031	430 10 GMFZ430N 430WGTZ KZISZ-6		Getr. / GBox: ZF 16S-151/181 H22 für Fahrzeuge mit Nebenantrieb / for vehicles with PTO	(73)		
05.04 -		 3496 006 000			H22 langer Bügel / long handle	(86)		
05.04 -								
05.04 -								
05.04 -								









		CODE				
--	--	------	--	---	---	---

MAN

TGA		03.00 -						
18.310, 18.320 FC, FLC, FLLC, FLLC/N, FLLW, FLLW/N H15 H03 H06 H10 18.310, 18.320 FK, FK-L, FLK, FLK/M H02 H03 H06 18.350, 18.360 FC, FLC, FLLC, FLLRC, FLLC/N, FLLW, FLLW/N H10 H15 H03 H06 18.350, 18.360 FK, FK-L, FLK, FLK/M, H06 H03 18.390, 18.400 FC, FLC, FLLC, FLLC/N, FLLW, FLLW/N H06 H10 H03 H15 18.390, 18.400 FK, FK-L, FLK, FLK/M H03 H06	05.04-	D2066LF28, D2066LF37, D2066LF27, D2066LF39, D2066LF03, D2066LF02, D2066LF26, D2066LF33, D2066LF35, D2066LF12, D2066LF14, D2066LF32, D2066LF13, D2066LF04, D2066LF38		3400 700 380 ● 3482 000 361 ● 1878 080 037 ● 3151 000 034	430 10 MFZ430 430WGTZ KZISZ-5	Getr. / GBox: ZF Ecosplit-3 H03		
	05.04-			3482 000 361 MFZ430	430 MFZ430	Getr. / GBox: AS-Tronic H03		
	05.04-			1878 080 037 D2066LF35, D2066LF12, D2066LF14, D2066LF32, D2066LF13, D2066LF04, D2066LF38	430 10 430WGTZ	430 10 430WGTZ	Getr. / GBox: AS-Tronic H03	
	05.04-				3151 000 144 KZISZ-5	430 10 MFZ430 430WGTZ KZISZ-5	Getr. / GBox: AS-Tronic H03 für Ausrückgabel mit Nocken / for release fork with cams	(69)
	05.04-				3400 700 381 ● 3482 000 361 ● 1878 080 037 ● 3151 000 493	430 10 MFZ430 430WGTZ KZISZ-5	Getr. / GBox: AS-Tronic H03 für Ausrückgabel mit Rollen / for release fork with rollers	(70)
	05.04-				3400 700 327 ● 3482 114 031 ● 1878 004 832 ● 3151 263 031	430 10 GMFZ430N 430WGTZ KZIZ-6	Getr. / GBox: ZF 16S-151/181 H03 für Fahrzeuge mit Nebenantrieb / for vehicles with PTO	(73)
	05.04-				3496 006 000 H03 langer Bügel / long handle		für Nebenantrieb / for PTO	(82)
						H03 langer Bügel / long handle	(86)	
18.310, 18.320 FLS, FLRS, FLLS, FLLRS H13 H06 H08 H10	05.04-	D2066LF28, D2066LF39, D2066LF35, D2066LF14, D2066LF04		3400 127 401 ● 3482 000 361 ● 1878 004 832 ● 3151 000 034	430 10 MFZ430 430WGTZ KZISZ-5	Getr. / GBox: ZF Ecosplit-3		
				3400 700 403 ● 3482 000 361 ● 1878 004 832 ● 3151 000 144	430 10 MFZ430 430WGTZ KZISZ-5	Getr. / GBox: AS-Tronic für Ausrückgabel mit Nocken / for release fork with cams	(69)	
				3400 700 450 ● 3482 000 361 ● 1878 004 832 ● 3151 000 493	430 10 MFZ430 430WGTZ KZISZ-5	Getr. / GBox: AS-Tronic für Ausrückgabel mit Rollen / for release fork with rollers	(70)	
				3496 006 000 langer Bügel / long handle				(86)
18.350 FLS, FLS/N, FLS/M, FLS-TS, FLLS, FLLS/N, FLLRS H10 H13 H65 H08 H06 18.390 FLS, FLS-TS, FLS/M, FLLS, FLLS/N, FLLS/M, FLLRS H06 H08 H10 H13 H65 18.430 FLS, FLS/M, FLS-TS, FLLS, FLLS/N, FLLRS, FLRS H08 H13 H10 H06 H65	05.04-	D2066LF03, D2066LF02, D2066LF11, D2066LF01, D2066LF12, D2066LF13		3400 700 380 ● 3482 000 361 ● 1878 080 037 ● 3151 000 034	430 10 MFZ430 430WGTZ KZISZ-5	Getr. / GBox: ZF Ecosplit-3		
	05.04-			3400 700 381 ● 3482 000 361 ● 1878 080 037 ● 3151 000 493	430 10 MFZ430 430WGTZ KZISZ-5	Getr. / GBox: ZF AS-Tronic für Ausrückgabel mit Rollen / for release fork with rollers	(70)	
	05.04-			3400 700 403 ● 3482 000 361 ● 1878 004 832 ● 3151 000 144	430 10 MFZ430 430WGTZ KZISZ-5	Getr. / GBox: ZF AS-Tronic für Ausrückgabel mit Nocken / for release fork with cams	(69)	
				3400 700 327 ● 3482 114 031 ● 1878 004 832 ● 3151 263 031	430 10 GMFZ430N 430WGTZ KZIZ-6	Getr. / GBox: ZF Ecosplit-3 für Fahrzeuge mit Nebenantrieb / for vehicles with PTO	(73)	
				3488 017 447 MFZ2/400X	400 MFZ2/400X	Getr. / GBox: ZF Ecosplit-3 für Fahrzeuge mit Zweischeibenkupplung / for vehicles with double disc clutch enthält eine Kupplungsscheibe / This part number includes one clutch disc	(77)	
				1878 002 643 400WGTZ	400 10 400WGTZ	Getr. / GBox: ZF Ecosplit-3 für Fahrzeuge mit Zweischeibenkupplung / for vehicles with double disc clutch	(77)	
				3151 262 031 KZISZ-5	400 10 400WGTZ	Getr. / GBox: ZF Ecosplit-3 für Fahrzeuge mit Zweischeibenkupplung / for vehicles with double disc clutch	(77)	
				3496 006 000 langer Bügel / long handle		Getr. / GBox: ZF langer Bügel / long handle	(86)	
				1863 869 038		Getr. / GBox: ZF		









		CODE		 Parameter		
--	--	------	--	---	---	---

MAN

TGA		03.00 -			
18.360 FLS, FLLS, FLRS, FLLRS H06 H13 H10 H08 H65	01.06-	 3400 700 380 ⊗ 3482 000 361 ⊗ 1878 080 037 ⊙ 3151 000 034	430 10 MFZ430 430WGTZ KZISZ-5	Getr. / GBox: ZF Ecosplit-3	
18.400 FLS, FLLS, FLRS, FLLRS H65 H08 H13 H06 H10	10.05-	 3482 000 361	430 MFZ430	Getr. / GBox: AS-Tronic	
18.440 FLS, FLLS, FLRS, FLLRS H08 H06 H13 H10	09.05-	 1878 080 037	430 10 430WGTZ	Getr. / GBox: AS-Tronic	
19.350 FS, FRS, FLS, FLRS-WW HW7 HW1 H64	05.04-	 3151 000 144	KZISZ-5	Getr. / GBox: AS-Tronic für Ausrückgabel mit Nocken / for release fork with cams	(69)
19.360 FS, FRS, FLS, FLRS-WW HW1 HW5 HW7 H64	05.04-	 3400 700 381 ⊗ 3482 000 361 ⊗ 1878 080 037 ⊙ 3151 000 493	430 10 MFZ430 430WGTZ KZISZ-5	Getr. / GBox: AS-Tronic für Ausrückgabel mit Rollen / for release fork with rollers	(70)
19.360 FS/M-WW, FRS/M-WW H60 H43	05.04-	 3400 700 327 ⊗ 3482 114 031 ⊗ 1878 004 832 ⊙ 3151 263 031	430 10 GMFZ430N 430WGTZ KZISZ-6	Getr. / GBox: ZF 16S-151/181 für Fahrzeuge mit Nebenantrieb / for vehicles with PTO	(73)
19.390 FS, FRS, FLS, FLRS-WW H64 HW1 HW7	05.04-	 3496 006 000		für Nebenantrieb / for PTO	(82)
19.400 FS/M-WW, FRS/M-WW, FLS, FLRS HW1 H64 HW7 HW5	05.04-	 1863 869 038		langer Bügel / long handle	(86)
19.410 FS/M-WW, FRS/M-WW H60 H43	05.04-				
19.430 FS/M-WW, FLS, FRS, FLRS HW7 HW1 H64	05.04-				
24.350, 24.360 FNLLC, FNLLW/N, FNLLRW H45	05.04-				
24.350, 24.360 FPLS, FPLRS H24	02.04-				
24.390, 24.400 FNLLC/N, FNLLW/N, FNLLRC, FNLLRW H45	05.04-				
24.390, 24.400 FPLS, FPLRS H24	05.04-				
24.430, 24.440 FNLLC/N, FNLRC, FNLLW H45	05.04-				
24.430, 24.440 FPLS, FPLRS H24	05.04-				
26.310 FDAC H56	01.04-				
26.310 FDAK H56	01.04-				
26.310 FDAS H56	01.04-				
26.310 FVLC H23	09.03-				
26.310, 26.320 FDH, FDHC, FDHC/M H47	06.05-				
26.310, 26.320 FDHK H47	06.05-				
26.310, 26.320 FDHS, FDHS/M H47	06.05-				
26.310, 26.320 FDH-TM H47	06.05-				
26.310, 26.320 FVLC H24	02.04-				
26.310, 26.320 FVL-KO H24	02.04-				
26.320 FDAC H56	04.06-				
26.320 FDAK H56	04.06-				









		CODE		 Parameter		
--	--	------	--	---	---	---

MAN

TGA		03.00 -				
26.320 FDAS H56	04.06-		3400 700 380 ⊗ 3482 000 361 ⊗ 1878 080 037 ⊙ 3151 000 034	430 10 MFZ430 430WGTZ KZISZ-5	Getr. / GBox: ZF Ecosplit-3	
26.350 FDAC H56	02.04-		3482 000 361	430 MFZ430	Getr. / GBox: AS-Tronic	
26.350 FDAK H56	02.04-		1878 080 037	430 10 430WGTZ	Getr. / GBox: AS-Tronic	
26.350 FDAS H56	02.04-		3151 000 144	KZISZ-5	Getr. / GBox: AS-Tronic für Ausrückgabel mit Nocken / for release fork with cams	(69)
26.350 FDHC, FDHC/M H47	04.05-		3400 700 381 ⊗ 3482 000 361 ⊗ 1878 080 037 ⊙ 3151 000 493	430 10 MFZ430 430WGTZ KZISZ-5	Getr. / GBox: AS-Tronic für Ausrückgabel mit Rollen / for release fork with rollers	(70)
26.350 FDLRC-WW H67	05.04-		3400 700 327 ⊗ 3482 114 031 ⊗ 1878 004 832 ⊙ 3151 263 031	430 10 GMFZ430N 430WGTZ KZISZ-6	Getr. / GBox: ZF 16S-151/181 für Fahrzeuge mit Nebenantrieb / for vehicles with PTO	(73)
26.350 FDLRS, FDLRS, FDLRS/M, FDLRS-WW HV2 H67 H30	05.04-				für Nebenantrieb / for PTO	(82)
26.350 FVHLC H42	06.05-		3496 006 000		langer Bügel / long handle	(86)
26.350 FVHLS H42	07.05-		1863 869 038			
26.350 FVLC H24	01.04-					
26.350 FVLS, FVLS H24	07.05-					
26.350, 26.360 FDHK, FDHLK HH1 H47	05.04-					
26.350, 26.360 FDHS, FDHS/M, FDHLS HH1 H47	05.04-					
26.350, 26.360 FDH-TM H47	05.04-					
26.350, 26.360 FVL-KO H24	01.04-					
26.360 FDAC, FDARC H56	06.04-					
26.360 FDAK, FDARK H56	06.04-					
26.360 FDAS, FDARS H56	06.04-					
26.360 FDHC, FDHLC H47 HH1	05.04-					
26.360 FDLC-WW, FDLRC H67	05.04-					
26.360 FDLRS, FDLRS-WW, FNHLS H35 H67	05.04-					
26.360 FVHLC H42	04.06-					
26.360 FVHLS H42	04.06-					
26.360 FVLC H24	04.06-					
26.360 FVLS, FVLS H24	04.06-					
26.390 FDAC, FDALC H56 H82	01.04-					
26.390 FDAK, FDALK H82 H56	02.04-					
26.390 FDAS, FDALS H56 H82	02.04-					
26.390 FDH-TM H47	06.05-					
26.390 FVLC H24	02.04-					
26.390 FVLS, FVLS H24	07.05-					









		CODE				
--	--	------	--	---	---	---

MAN

TGA		03.00 -			
26.390, 26.400 FDHC, FDHC/M, FDHLC H47 HH1	06.05-	 3400 700 380 ⊙ 3482 000 361 ⊙ 1878 080 037 ⊙ 3151 000 034	430 10 MFZ430 430WGTZ KZISZ-5	Getr. / GBox: ZF Ecosplit-3	
26.390, 26.400 FDHK, FDHLK H47 HH1	06.05-	 3482 000 361	430 MFZ430	Getr. / GBox: AS-Tronic	
26.390, 26.400 FDHS, FDHS/M, FDHLS HH1 H47	06.05-	 1878 080 037	430 10 430WGTZ	Getr. / GBox: AS-Tronic	
26.390, 26.400 FVL-KO H24	02.04-	 3151 000 144	KZISZ-5	Getr. / GBox: AS-Tronic für Ausrückgabel mit Nocken / for release fork with cams	(69)
26.400 FDAC, FDALC H56 H82	01.04-	 3400 700 381 ⊙ 3482 000 361 ⊙ 1878 080 037 ⊙ 3151 000 493	430 10 MFZ430 430WGTZ KZISZ-5	Getr. / GBox: AS-Tronic für Ausrückgabel mit Rollen / for release fork with rollers	(70)
26.400 FDAQ, FDALK H56 H82	01.04-	 3400 700 327 ⊙ 3482 114 031 ⊙ 1878 004 832 ⊙ 3151 263 031	430 10 GMFZ430N 430WGTZ KZISZ-6	Getr. / GBox: ZF 16S-151/181 für Fahrzeuge mit Nebenantrieb / for vehicles with PTO	(73)
26.400 FDAS, FDALS H56 H82	01.04-			für Nebenantrieb / for PTO	(82)
26.400 FDH-TM H47	04.06-	 3496 006 000		langer Bügel / long handle	(86)
26.400 FVLS, FVLRS H24	04.06-	 1863 869 038			
26.410 FVLC H23	09.03-				
26.410 FVLS, FVLRS H23	07.05-				
26.430 FDAC, FDALC H56 H82	01.04-				
26.430 FDAQ, FDALK H56 H82	01.04-				
26.430 FDAS, FDALS H82 H56	01.04-				
26.430 FDLS, FDLS/M, FDLRS- WW HV2 H67	02.04-				
26.430 FVL-KO H24	12.00-				
26.430 FVLS, FVLRS H24	07.05-				
26.430, 26.440 FDHC, FDHC/M, FDHLC H47 HH1	06.05-				
26.430, 26.440 FDHK, FDHLK H47 HH1	06.05-				
26.430, 26.440 FDHS, FDHS/M, FDHLS H47 HH1	06.05-				
26.430, 26.440 FDH-TM H47	06.05-				
26.440 FDAC, FDALC H82 H56	09.05-				
26.440 FDAQ, FDALK H82 H56	01.04-				
26.440 FDAS, FDALS H56 H82	01.04-				
26.440 FVL-KO H24	09.05-				
26.440 FVLS, FVLRS H24	09.05-				
28.310 FNLC, FNLLC H71	09.02-				
28.310 FNLC, FNLLC, FNLRC H89 H85	09.02-				
28.310 FNLS, FNLRS H89	06.04-				
28.310, 28.320 FNLC, FNLLC, FNLL-LE, FNLLR-LE H99 H74 H75	07.06-				









		CODE				
--	--	------	--	---	---	---

MAN

TGA		03.00 -			
28.310, 28.320 FNLC, FNLLC, FNLLRC, FNLLR-LE H74 H89 H99	07.06-	 3400 700 380 ⊗ 3482 000 361 ⊗ 1878 080 037 ⊙ 3151 000 034	430 10 MFZ430 430WGTZ KZISZ-5	Getr. / GBox: ZF Ecosplit-3	
28.320 FNLC, FNLLC, FNLR H85 H89	06.04-	 3482 000 361	430 MFZ430	Getr. / GBox: AS-Tronic	
28.320 FNLS, FNLR H89	06.04-	 1878 080 037	430 10 430WGTZ	Getr. / GBox: AS-Tronic	
28.350 FANLC H84	07.06-	 3151 000 144	KZISZ-5	Getr. / GBox: AS-Tronic für Ausrückgabel mit Nocken / for release fork with cams	(69)
28.350 FANLK H84	07.06-				
28.350 FNLS, FNLR-WW HV4 HV7 H89	02.04-	 3400 700 381 ⊗ 3482 000 361 ⊗ 1878 080 037 ⊙ 3151 000 493	430 10 MFZ430 430WGTZ KZISZ-5	Getr. / GBox: AS-Tronic für Ausrückgabel mit Rollen / for release fork with rollers	(70)
28.350, 28.360 FNLC, FNLLC, FNLL-LE H74 H99 H75 H89	07.06-	 3400 700 327 ⊗ 3482 114 031 ⊗ 1878 004 832 ⊙ 3151 263 031	430 10 GMFZ430N 430WGTZ KZISZ-6	Getr. / GBox: ZF 16S-151/181 für Fahrzeuge mit Nebenantrieb / for vehicles with PTO	(73)
28.350, 28.360 FNLC, FNLLC, FNLR, FNLL-LE H85 H89 H74 HV4 H75 H99	06.04-	 3496 006 000		für Nebenantrieb / for PTO	(82)
28.360 FANLC H81	07.06-			langer Bügel / long handle	(86)
28.360 FANLC H84	07.06-	 1863 869 038			
28.360 FANLK H81	07.06-				
28.360 FANLK H84	07.06-				
28.360 FNLC, FNLLC H71	09.02-				
28.360 FNLS, FNLR-WW H89	04.06-				
28.390 FANLC H84	07.06-				
28.390 FANLK H84	07.06-				
28.390 FNLS, FNLR H89 HV4 HV7	05.04-				
28.390, 28.400 FNLC, FNLLC, FNLR-WW H74 H75 HV4 HV7 H85 H89	06.04-				
28.400 FANLC H84	07.06-				
28.400 FANLK H74	07.06-				
28.400 FNLS, FNLR H89	04.06-				
28.410 FANLC H81	07.06-				
28.410 FANLK H81	07.06-				
28.410 FNLC, FNLLC H71	09.02-				
28.430 FANLC H84	07.06-				
28.430 FANLK H84	07.06-				
28.430 FNLS, FNLR-WW H89 HV4 HV7	05.04-				
28.430, 28.440 FNLC, FNLLC, FNLR-WW H74 H85 H89 HV7 HV4 H75	06.04-				
28.440 FANLC H84	07.06-				
28.440 FANLK H84	07.06-				
28.440 FNLS, FNLR-WW H89	09.05-				









		CODE				
--	--	------	--	---	---	---

MAN

TGA		03.00 -				
32.350, 32.360 FFDC HV8 H49	05.04-		3400 700 380 ⊗ 3482 000 361 ⊗ 1878 080 037 ⊙ 3151 000 034	430 10 MFZ430 430WGTZ KZISZ-5	Getr. / GBox: ZF Ecosplit-3	
32.350, 32.360 FFD-TM, FFDR-TM H49	02.04-		3482 000 361	430 MFZ430	Getr. / GBox: AS-Tronic	
32.390, 32.400 FFDC H49	05.04-		1878 080 037	430 10 430WGTZ	Getr. / GBox: AS-Tronic	
32.390, 32.400 FFD-TM, FFDR-TM H49	05.04-		3151 000 144	KZISZ-5	Getr. / GBox: AS-Tronic für Ausrückgabel mit Nocken / for release fork with cams	(69)
32.430, 32.440 FFDC H49	05.04-		3400 700 381 ⊗ 3482 000 361 ⊗ 1878 080 037 ⊙ 3151 000 493	430 10 MFZ430 430WGTZ KZISZ-5	Getr. / GBox: AS-Tronic für Ausrückgabel mit Rollen / for release fork with rollers	(70)
32.430, 32.440 FFD-TM, FFDR-TM H49	05.04-		3400 700 327 ⊗ 3482 114 031 ⊗ 1878 004 832 ⊙ 3151 263 031	430 10 GMFZ430N 430WGTZ KZISZ-6	Getr. / GBox: ZF 16S-151/181 für Fahrzeuge mit Nebenantrieb / for vehicles with PTO für Nebenantrieb / for PTO	(73) (82)
33.350 FDC-TM, FDRC-TM HW2	09.07-		3496 006 000		langer Bügel / long handle	(86)
33.350, 33.360 FDAC, FDHC, FDHC/M H47 HW4 H56	06.05-		1863 869 038			
33.350, 33.360 FDAK, FDHK H56 H47 HW4	06.05-					
33.350, 33.360 FDAS, FDHS, FDHS/M H56 H47 HW4	06.05-					
33.360 FDC-TM, FDRC-TM HW2	09.07-					
33.390, 33.400 FDAC, FDHC, FDHC/M HW4 H56 H47	06.05-					
33.390, 33.400 FDAK, FDHK HW4 H47 H56	06.05-					
33.390, 33.400 FDAS, FDHS, FDHS/M H47 HW4 H56	06.05-					
33.390, 33.400 FDC-TM, FDRC-TM HW2	09.07-					
33.430, 33.440 FDAC, FDALC, FDHC, FDHC/M H82 H56 HW4 H47	06.05-					
33.430, 33.440 FDAK, FDALK, FDHK H56 HW4 H82 H47	06.05-					
33.430, 33.440 FDAS, FDALS, FDHS H82 H56 H47 HW4	06.05-					
35.310, 35.320 FFDC, FFDC H37 H41	02.04-					
35.310, 35.320 FFDK, FFDLK H41 H37	02.04-					
35.310, 35.320 FFD-TM H37	02.04-					
35.350 FFDHK, FFDHLK H50 H59	07.06-					
35.350 FFDH-TM H50	07.06-					
35.350 FFNLC H90	07.06-					
35.350, 35.360 FFDC, FFDC H41 H37	02.04-					
35.350, 35.360 FFDK, FFDRK, FFDLK H41 H37	02.04-					
35.350, 35.360 FFD-TM H37	02.04-					









		CODE				
--	--	------	--	---	---	---









MAN

TGA		03.00 -					
35.360 FFDHK, FFDHLK H59 H50	07.06-		 3400 700 380 ⊗ 3482 000 361 ⊗ 1878 080 037 ⊙ 3151 000 034	430 10 MFZ430 430WGTZ KZISZ-5	Getr. / GBox: ZF Ecosplit-3		
35.360 FFDH-TM H50	07.06-		 3482 000 361	430 MFZ430	Getr. / GBox: AS-Tronic		
35.360 FFNHLC HH4	07.06-		 1878 080 037	430 10 430WGTZ	Getr. / GBox: AS-Tronic		
35.360 FFNLC H90	07.06-		 3151 000 144	KZISZ-5	Getr. / GBox: AS-Tronic für Ausrückgabel mit Nocken / for release fork with cams	(69)	
35.360 FFNLC H88	07.06-		 3400 700 381 ⊗ 3482 000 361 ⊗ 1878 080 037 ⊙ 3151 000 493	430 10 MFZ430 430WGTZ KZISZ-5	Getr. / GBox: AS-Tronic für Ausrückgabel mit Rollen / for release fork with rollers	(70)	
35.390 FDNLC H92	07.06-		 3400 700 327 ⊗ 3482 114 031 ⊗ 1878 004 832 ⊙ 3151 263 031	430 10 GMFZ430N 430WGTZ KZISZ-6	Getr. / GBox: ZF 16S-151/181 für Fahrzeuge mit Nebenantrieb / for vehicles with PTO	(73)	
35.390 FFDAC H96 HV6	02.04-		 3496 006 000		langer Bügel / long handle	(82)	
35.390 FFDAC, FFDHK, FFDHLK H93 H50 H59	07.06-		 1863 869 038			(86)	
35.390 FFDH-TM H50	07.06-						
35.390 FFNLC H90	07.06-						
35.390, 35.400 FFDC, FFDC, FFDLC H37 HW3 H41	02.04-						
35.390, 35.400 FFDK, FFDRK, FFDLK H37 H41	02.04-						
35.390, 35.400 FFD-TM H37	02.04-						
35.400 FDNLC H92	07.06-						
35.400 FFDAC H96	02.04-						
35.400 FFDAC, FFDHK, FFDHLK H59 H50 H93	07.06-						
35.400 FFDH-TM H50	07.06-						
35.400 FFNHLC HH4	11.06-						
35.400 FFNLC H90	07.06-						
35.410 FDNLC H91	07.06-						
35.410 FFDAC H73	07.06-						
35.410 FFDAC H76	07.06-						
35.410 FFNLC H88	07.06-						
35.430 FDNLC H92	07.06-						
35.430 FFDAC, FFDHK, FFDHLK H50 H93 H59	07.06-						
35.430 FFDAC, FFDHK, FFDHLK H59 H93 H96 H50	07.06-						
35.430 FFDH-TM H50	07.06-						
35.430 FFNLC H90	07.06-						
35.430, 35.440 FFDC, FFDC, FFDLC H37 H41	02.04-						

		CODE				
--	--	------	--	---	---	---













































MAN

TGA		03.00 -			
35.430, 35.440 FFDK, FFDRK, FFDLK H37 H41	02.04-	 3400 700 380 ⊙ 3482 000 361 ⊙ 1878 080 037 ⬥ 3151 000 034	430 10 MFZ430 430WGTZ KZISZ-5	Getr. / GBox: ZF Ecosplit-3	
35.430, 35.440 FFD-TM H37	02.04-	 3482 000 361	430 MFZ430	Getr. / GBox: AS-Tronic	
35.440 FDNLC H92	07.06-	 1878 080 037	430 10 430WGTZ	Getr. / GBox: AS-Tronic	
35.440 FFDAK, FFDHK, FFDHLK H50 H59 H96	07.06-	 3151 000 144	KZISZ-5	Getr. / GBox: AS-Tronic für Ausrückgabel mit Nocken / for release fork with cams	(69)
35.440 FFDH-TM H50	07.06-	 3400 700 381 ⊙ 3482 000 361 ⊙ 1878 080 037 ⬥ 3151 000 493	430 10 MFZ430 430WGTZ KZISZ-5	Getr. / GBox: AS-Tronic für Ausrückgabel mit Rollen / for release fork with rollers	(70)
35.440 FFNHLC HH4	11.06-				
35.440 FFNLC H90	07.06-	 3400 700 327 ⊙ 3482 114 031 ⊙ 1878 004 832 ⬥ 3151 263 031	430 10 GMFZ430N 430WGTZ KZISZ-6	Getr. / GBox: ZF 16S-151/181 für Fahrzeuge mit Nebenantrieb / for vehicles with PTO	(73)
37.310 FFDC H38	12.04-	 3496 006 000		langer Bügel / long handle	(82)
37.310 FFDK H38	12.04-	 1863 869 038			(86)
37.310 FFD-TM H38	12.04-				
37.310, 37.320 FFDC H39	12.04-				
37.310, 37.320 FFDK H39	12.04-				
37.310, 37.320 FFD-TM H39	12.04-				
37.350, 37.360 FFDC H39	12.04-				
37.350, 37.360 FFDK H39	12.04-				
37.350, 37.360 FFD-TM H39	12.04-				
37.360 FFD-TM H38	12.04-				
37.360 FFDC H38	12.04-				
37.360 FFDK H38	12.04-				
37.390, 37.400 FFD-TM H39	12.04-				
37.390, 37.400 FFDC H39	12.04-				
37.390, 37.400 FFDK H39	12.04-				
37.410 FFD-TM H38	12.04-				
37.410 FFDC H38	12.04-				
37.410 FFDK H38	12.04-				
37.430, 37.440 FFD-TM H39	12.04-				
37.430, 37.440 FFDC H39	12.04-				
37.430, 37.440 FFDK H39	12.04-				
39.390 FVNLC H69	07.06-				
39.400 FVNLC H69	07.06-				
39.430 FVNLC H69	07.06-				
39.440 FVNLC H69	07.06-				

TGA		03.00 -			
40.390, 40.400 FDAK-WW H58	06.05-	 3400 700 380 ⊗ 3482 000 361 ⊗ 1878 080 037 ⊙ 3151 000 034	430 10 MFZ430 430WGTZ KZISZ-5	Getr. / GBox: ZF Ecosplit-3	
40.390, 40.400 FDAS-WW H58	06.05-	 3482 000 361	430 MFZ430	Getr. / GBox: AS-Tronic	
40.390, 40.400 FDK-WW, FDRK H11 H34	06.05-	 1878 080 037	430 10 430WGTZ	Getr. / GBox: AS-Tronic	
40.390, 40.400 FDS-WW, FDRS H34	06.05-	 3151 000 144	KZISZ-5	Getr. / GBox: AS-Tronic für Ausrückgabel mit Nocken / for release fork with cams	(69)
40.410 FDAK-WW H57	04.04-	 3400 700 381 ⊗ 3482 000 361 ⊗ 1878 080 037 ⊙ 3151 000 493	430 10 MFZ430 430WGTZ KZISZ-5	Getr. / GBox: AS-Tronic für Ausrückgabel mit Rollen / for release fork with rollers	(70)
40.410 FDAS-WW H57	04.04-	 3400 700 327 ⊗ 3482 114 031 ⊗ 1878 004 832 ⊙ 3151 263 031	430 10 GMFZ430N 430WGTZ KZISZ-6	Getr. / GBox: ZF 16S-151/181 für Fahrzeuge mit Nebenantrieb / for vehicles with PTO	(73)
40.410 FDK-WW H68 H33	04.04-			für Nebenantrieb / for PTO	(82)
40.410 FDS-WW H33	04.04-	 3496 006 000		langer Bügel / long handle	(86)
40.430 FDK-WW, FDRK H34	06.05-	 1863 869 038			
40.430 FDS-WW, FDRS H34	06.05-				
40.430, 40.440 FDAK-WW H58	06.05-				
40.430, 40.440 FDAS-WW H58	06.05-				
40.480 FDS-WW; FDRS H33 H34	06.05-				
41.350 FFDC-TM, FFDRK-TM HW3	09.07-				
41.350, 41.360 FFD-TM HW6 H39	12.04-				
41.350, 41.360 FFDC, FFDC/M, FFDRK H39 HW3	12.04-				
41.350, 41.360 FFDK, FFDRK H39 HW3	12.04-				
41.360 FFD HW6	12.08-				
41.360 FFD-TM H38	12.04-				
41.360 FFDC-TM, FDRK-TM HW3	09.07-				
41.360 FFDK-WW H46 H38	09.03-				
41.390 FFDAK HV6	12.04-				
41.390 FFDC-TM, FDRK-TM HW3	09.07-				
41.390, 41.400 FFDC, FFDRK, FFDC/M H39 HW3	12.04-				
41.390, 41.400 FFDK, FFDRK H39 HW6 HW3	12.04-				
41.390, 41.400 FFD-TM HW6 H39	12.04-				
41.400 FFD HW6	12.08-				
41.400 FFDC-TM, FDRK-TM HW3	09.07-				
41.410 FFD-TM H38	12.04-				
41.410 FFDAK H73	07.06-				
41.410 FFDAK H76	07.06-				

























		CODE				
--	--	------	--	---	---	---

MAN

TGA		03.00 -						
41.410 FFDC-WW, FDRC H46 H38 41.410 FFDK-WW H46 H38 41.430 FFDK HV6 H93 H96 41.430 FFDK H93 41.430 FFDC-TM, FFDRC HW3 41.430, 41.440 FFD-TM H39 41.430, 41.440 FFDC, FFDRC, FFDK/M H39 HW3 41.430, 41.440 FFDK, FFDRC H39 HW3 41.440 FFDK H93 41.440 FFDK H96	09.03-			3400 700 380  3482 000 361  1878 080 037  3151 000 034	430 10 MFZ430 430WGTZ KZISZ-5	Getr. / GBox: ZF Ecosplit-3		
		09.03-			3482 000 361	430 MFZ430	Getr. / GBox: AS-Tronic	
		12.04-			1878 080 037	430 10 430WGTZ	Getr. / GBox: AS-Tronic	
		07.06-			3151 000 144	KZISZ-5	Getr. / GBox: AS-Tronic für Ausrückgabel mit Nocken / for release fork with cams	(69)
		09.07-			3400 700 381  3482 000 361  1878 080 037  3151 000 493	430 10 MFZ430 430WGTZ KZISZ-5	Getr. / GBox: AS-Tronic für Ausrückgabel mit Rollen / for release fork with rollers	(70)
		12.04-			3400 700 327  3482 114 031  1878 004 832  3151 263 031	430 10 GMFZ430N 430WGTZ KZISZ-6	Getr. / GBox: ZF 16S-151/181 für Fahrzeuge mit Nebenantrieb / for vehicles with PTO	(73)
		12.04-					für Nebenantrieb / for PTO	(82)
		07.06-			3496 006 000		langer Bügel / long handle	(86)
		07.06-			1863 869 038			
	18.430, 18.440 FAC, FHLC H22 H52 HV5 18.430, 18.440 FAK, FALK, FALK-L, FHLK, FHLK/M H52 H80 HV5 H22 18.430, 18.440 FAS, FALS, FHLS, FHLS/M H52 HV5 H22 H80 18.480 FHLC H22 18.480 FHLK, FHLK/M H22 18.480 FHLS, FHLS/M H22	05.04-	D2066LF11, D2066LF31, D2066LF01, D2066LF36, D2676LF05, D2676LF01		3400 700 402  3482 000 246  1878 002 139  3151 000 034	430 10 MFZ430 430WGTZ KZISZ-5	Getr. / GBox: ZF Ecosplit-3 H22	
05.04-				3400 700 460 HD  3482 000 246  1878 004 104  3151 000 034	430 10 MFZ430 430WGTZ KZISZ-5	Getr. / GBox: ZF Ecosplit-3 H22		
05.04-				3400 700 404  3482 000 246  1878 002 139  3151 000 144	430 10 MFZ430 430WGTZ KZISZ-5	Getr. / GBox: AS-Tronic H22		
04.06-				3400 700 445  3482 000 246  1878 002 139  3151 000 493	430 10 MFZ430 430WGTZ KZISZ-5	Getr. / GBox: AS-Tronic H22 für Ausrückgabel mit Rollen / for release fork with rollers	(70)	
04.06-				3400 700 459 HD  3482 000 246  1878 004 104  3151 000 493	430 10 MFZ430 430WGTZ KZISZ-5	Getr. / GBox: AS-Tronic H22 für Ausrückgabel mit Rollen / for release fork with rollers	(70)	
04.06-				3400 700 327  3482 114 031  1878 004 832  3151 263 031	430 10 GMFZ430N 430WGTZ KZISZ-6	Getr. / GBox: ZF 16S-151/181 H22 für Fahrzeuge mit Nebenantrieb / for vehicles with PTO	(73)	
							für Nebenantrieb / for PTO	(82)
					3496 006 000		H22 langer Bügel / long handle	(86)









		CODE				
--	--	------	--	---	---	---

MAN

TGA		03.00 -				
18.430, 18.440 FC, FLC, FLLC, FLLW, FLLW/N, FLLRC, FLLRW H06 H03 H15 H10 18.430, 18.440 FK, FK-L, FLK, FLK/M H03 H06 18.480 FC, FLC, FLLC, FLLRC, FLLW, FLRC H03 H06 H15 H10 18.480 FK, FK-L, FLK H03 H06	05.04-	D2676LF14, D2066LF11, D2066LF25, D2066LF31, D2066LF01, D2066LF36, D2676LF05, D2676LF01	 3400 700 402  3482 000 246  1878 002 139  3151 000 034	430 10 MFZ430 430WGTZ KZISZ-5	Getr. / GBox: ZF Ecosplit-3 H03	
	05.04-		 3400 700 460 HD  3482 000 246  1878 004 104  3151 000 034	430 10 MFZ430 430WGTZ KZISZ-5	Getr. / GBox: ZF Ecosplit-3 H03	
	01.06-		 3400 700 404  3482 000 246  1878 002 139  3151 000 144	430 10 MFZ430 430WGTZ KZISZ-5	Getr. / GBox: AS-Tronic H03	
	01.06-		 3400 700 445  3482 000 246  1878 002 139  3151 000 493	430 10 MFZ430 430WGTZ KZISZ-5	Getr. / GBox: AS-Tronic H03 für Ausrückgabel mit Rollen / for release fork with rollers	(70)
			 3400 700 459 HD  3482 000 246  1878 004 104  3151 000 493	430 10 MFZ430 430WGTZ KZISZ-5	Getr. / GBox: AS-Tronic H03 für Ausrückgabel mit Rollen / for release fork with rollers	(70)
			 3400 700 327  3482 114 031  1878 004 832  3151 263 031	430 10 GMFZ430N 430WGTZ KZIZ-6	Getr. / GBox: ZF 16S-151/181 H03 für Fahrzeuge mit Nebenantrieb / for vehicles with PTO für Nebenantrieb / for PTO	(73) (82)
			 3496 006 000		H03 langer Bügel / long handle	(86)









		CODE				
--	--	------	--	---	---	---

MAN

TGA		03.00 -				
18.460 FAK	12.00-	D2866LF26,	 3400 700 402 ⊗ 3482 000 246 ⊗ 1878 002 139 ⊙ 3151 000 034	430 10 MFZ430 430WGTZ KZISZ-5	Getr. / GBox: ZF Ecosplit-3	
18.480 FAC H52	02.06-	D2866LF27, D2676LF04, D2866LF28,	 3400 700 460 HD ⊗ 3482 000 246 ⊗ 1878 004 104 ⊙ 3151 000 034	430 10 MFZ430 430WGTZ KZISZ-5	Getr. / GBox: ZF Ecosplit-3	
18.480 FAK, FALK H52	02.06-	D2876LF07, D2676LF13, D2676LF14, D2676LF05, D2876LF12,	 3400 700 404 ⊗ 3482 000 246 ⊗ 1878 002 139 ⊙ 3151 000 144	430 10 MFZ430 430WGTZ KZISZ-5	Getr. / GBox: AS-Tronic	
18.480 FAS, FALS H52 H80	02.06-	D2676LF02, D2676LF01, D2676LF12,	 3400 700 445 ⊗ 3482 000 246 ⊗ 1878 002 139 ⊙ 3151 000 493	430 10 MFZ430 430WGTZ KZISZ-5	Getr. / GBox: AS-Tronic für Ausrückgabel mit Rollen / for release fork with rollers	(70)
18.480 FLS, FLLS, FLRS, FLLRS H08 H13 H06 H10	01.06-	D2876LF25, D2676LF11, D2876LF04, D2876LF13, D2676LF03	 3400 700 459 HD ⊗ 3482 000 246 ⊗ 1878 004 104 ⊙ 3151 000 493	430 10 MFZ430 430WGTZ KZISZ-5	Getr. / GBox: AS-Tronic für Ausrückgabel mit Rollen / for release fork with rollers	(70)
18.530 FAC H51	04.04-		 3400 700 327 ⊗ 3482 114 031 ⊗ 1878 004 832 ⊙ 3151 263 031	430 10 GMFZ430N 430WGTZ KZIZ-6	Getr. / GBox: ZF 16S-151/181 für Fahrzeuge mit Nebenantrieb / for vehicles with PTO	(73)
18.530 FAK, FALK H51 H70	04.04-		 3496 006 000		langer Bügel / long handle	(86)
18.530 FAS, FALS H51 H70	04.04-		 1863 869 038			
18.540 FLC, FLRC, FLLC, FLLRC, FLLW H06 H10 H15	08.06-					
18.540 FLS, FLRS, FLLS, FLLRS H13 H10 H06	08.06-					
19.440 FRS, FS/M-WW, FLS, FLRS HW1 H64 HW7 HW5	02.06-					
19.460 FS/M-WW, FRS/M-WW H43 H60	05.04-					
19.480 FLS, FRS, FLRS-WW HW1 H64 HW5 HW7	02.06-					
19.480 FS/M, FRS/M-WW H64 HW1	02.06-					
19.480 FS/M-WW, FRS/M-WW H60 H43	05.04-					
24.480 FNLLC/N, FNLLW/N H45	01.06-					
24.480 FPLS, FPLRS H24	01.06-					
24.480 FPLS, FPLRS H23	07.05-					
24.530 FPLS, FPLRS H23	07.05-					
24.540 FNLLC/N, FLLCW/N H45	01.06-					
26.440 FDLC-WW, FDLRC-WW H67	02.06-					
26.440 FDS, FDLS, FDLS-WW, FDLRS-WW H67	02.06-					
26.480 FDAC, FDALC H82 H56	02.06-					
26.480 FDAK, FDALK H82 H56	02.06-					
26.480 FDAS, FDALS H56 H82	02.06-					
26.480 FDHC, FDHC/M, FDHLC HH1 H47	02.06-					
26.480 FDHK, FDHLK HH1 H47	02.06-					
26.480 FDHS, FDHS/M, FDHLS H47 HH1	02.06-					
26.480 FDH-TM H47	02.06-					
26.480 FVL-KO H24	01.06-					
26.530 FDAC, FDALC H72 H55	07.06-					









		CODE					
--	--	------	--	--	---	---	---







MAN

TGA		03.00 -				
26.530 FDAK, FDALK H55 H72	09.02-	D2866LF26, D2866LF27, D2676LF04, D2866LF28,	 3400 700 402 ⊗ 3482 000 246 ⊗ 1878 002 139 ⊙ 3151 000 034	430 10 MFZ430 430WGTZ KZISZ-5	Getr. / GBox: ZF Ecosplit-3	
26.530 FDAS, FDALS H55 H72	07.06-	D2866LF28, D2876LF07, D2676LF13, D2676LF14, D2676LF05, D2876LF12,	 3400 700 460 HD ⊗ 3482 000 246 ⊗ 1878 004 104 ⊙ 3151 000 034	430 10 MFZ430 430WGTZ KZISZ-5	Getr. / GBox: ZF Ecosplit-3	
26.540 FNLC, FNLLC, FNLLRC, FNLLW H18 H21	08.06-	D2876LF12, D2676LF02, D2676LF01, D2676LF12, D2876LF25, D2676LF11, D2876LF04, D2876LF13, D2676LF03	 3400 700 404 ⊗ 3482 000 246 ⊗ 1878 002 139 ⊙ 3151 000 144	430 10 MFZ430 430WGTZ KZISZ-5	Getr. / GBox: AS-Tronic	
27.440 FDS, FDLS, FDRS, FDLRS	10.08-		 3400 700 445 ⊗ 3482 000 246 ⊗ 1878 002 139 ⊙ 3151 000 493	430 10 MFZ430 430WGTZ KZISZ-5	Getr. / GBox: AS-Tronic für Ausrückgabel mit Rollen / for release fork with rollers	(70)
28.390 FNLLC H81	07.06-		 3400 700 459 HD ⊗ 3482 000 246 ⊗ 1878 004 104 ⊙ 3151 000 493	430 10 MFZ430 430WGTZ KZISZ-5	Getr. / GBox: AS-Tronic für Ausrückgabel mit Rollen / for release fork with rollers	(70)
28.480 FANLC H84	07.06-		 3400 700 327 ⊗ 3482 114 031 ⊗ 1878 004 832 ⊙ 3151 263 031	430 10 GMFZ430N 430WGTZ KZIZ-6	Getr. / GBox: ZF 16S-151/181 für Fahrzeuge mit Nebenantrieb / for vehicles with PTO	(73)
28.480 FANLC H81	07.06-		 3400 700 327 ⊗ 3482 114 031 ⊗ 1878 004 832 ⊙ 3151 263 031	430 10 GMFZ430N 430WGTZ KZIZ-6	für Nebenantrieb / for PTO	(82)
28.480 FANLC H84	07.06-		 3496 006 000		langer Bügel / long handle	(86)
28.480 FNLC, FNLLC- FNLLC H89 H85 HV7 HV4	02.06-		 1863 869 038			
28.480 FNLS, FNLLS- FNLLS H89 HV4 HV7	02.06-					
28.530 FANLC H81	07.06-					
28.530 FANLC H81	07.06-					
28.540 FNLC, FNLLC H85 H89	08.06-					
28.540 FNLS H89	08.06-					
32.480 FFDRS H49	02.06-					
32.480 FFD-TM, FFD- TM H49	02.06-					
33.440 FDAC, FDHC HW4	06.05-					
33.440 FDAK, FDHK HW4	06.05-					
33.440 FDAS, FDHS HW4	06.05-					
33.440 FDC, FDRS HW2 H66	06.05-					
33.440 FDC-TM, FDC- TM HW2	09.07-					
33.440 FDK, FDRK HW2 H66	06.05-					
33.440 FDS, FDRS HW8 H66 HW2 HW9	06.05-					
33.460 FDAC-WW H54	09.02-					
33.460 FDAK-WW H54	09.02-					
33.460 FDAS-WW H54	09.02-					
33.480 FDAC, FDALC, FDHC, FDHC/M H47 H56 HW4 H82	02.06-					
33.480 FDAK, FDALK, FDHK H47 H56 H82 HW4	02.06-					
33.480 FDAS, FDALS, FDHS H47 H82 H56 HW4	02.06-					
33.480 FDC-TM, FDC- TM HW2	09.07-					

		CODE				
--	--	------	--	---	---	---







MAN

TGA		03.00 -				
33.530 FDAC, FDALC H55 H72	09.02-	D2866LF26, D2866LF27, D2676LF04, D2866LF28,	 3400 700 402 ⊗ 3482 000 246 ⊗ 1878 002 139 ⊙ 3151 000 034	430 10 MFZ430 430WGTZ KZISZ-5	Getr. / GBox: ZF Ecosplit-3	
35.310 FFDC, FFDLC H40 H36	06.03-	D2876LF07, D2676LF13, D2676LF14, D2676LF05, D2876LF12,	 3400 700 460 HD ⊗ 3482 000 246 ⊗ 1878 004 104 ⊙ 3151 000 034	430 10 MFZ430 430WGTZ KZISZ-5	Getr. / GBox: ZF Ecosplit-3	
35.310 FFDK, FFDLC H40 H36	06.03-	D2676LF02, D2676LF01, D2676LF12, D2876LF25, D2676LF11, D2876LF04, D2876LF13, D2676LF03	 3400 700 404 ⊗ 3482 000 246 ⊗ 1878 002 139 ⊙ 3151 000 144	430 10 MFZ430 430WGTZ KZISZ-5	Getr. / GBox: AS-Tronic	
35.360 FFDK, FFDLC H40 H36	10.03-		 3400 700 445 ⊗ 3482 000 246 ⊗ 1878 002 139 ⊙ 3151 000 493	430 10 MFZ430 430WGTZ KZISZ-5	Getr. / GBox: AS-Tronic für Ausrückgabel mit Rollen / for release fork with rollers	(70)
35.360 FFDK, FFDLC H40 H36	10.03-		 3400 700 459 HD ⊗ 3482 000 246 ⊗ 1878 004 104 ⊙ 3151 000 493	430 10 MFZ430 430WGTZ KZISZ-5	Getr. / GBox: AS-Tronic für Ausrückgabel mit Rollen / for release fork with rollers	(70)
35.410 FFDK, FFDLC H36 H40	10.03-		 3400 700 327 ⊗ 3482 114 031 ⊗ 1878 004 832 ⊙ 3151 263 031	430 10 GMFZ430N 430WGTZ KZIZ-6	Getr. / GBox: ZF 16S-151/181 für Fahrzeuge mit Nebenantrieb / for vehicles with PTO	(73)
35.410 FFDK, FFDLC H36 H40	11.03-				für Nebenantrieb / for PTO	(82)
35.460 FFDK, FFDLC H40 H36	10.03-		 3496 006 000		langer Bügel / long handle	(86)
35.460 FFDK, FFDLC H36 H40	10.03-		 1863 869 038			
35.460 FFDK, FFDLC H36 H40	10.03-					
35.460 FFNLC H88	07.06-					
35.480 FDNLC H92	07.06-					
35.480 FDNLC H91	07.06-					
35.480 FFDK, FFDLC H76	07.06-					
35.480 FFDK, FFDLC H73	07.06-					
35.480 FFDK, FFDLC HV6 H96	07.06-					
35.480 FFDK, FFDK, FFDHLK H59 H93 H50	07.06-					
35.480 FFDK, FFDLC H76	07.06-					
35.480 FFDK, FFDLC H36 H40	10.03-					
35.480 FFDK, FFDLC H37 H41	02.04-					
35.480 FFDH-TM H50	07.06-					
35.480 FFDK, FFDLC H37 H41	02.04-					
35.480 FFDK, FFDLC H40 H36	10.03-					
35.480 FFD-TM H37	02.04-					
35.480 FFD-TM H36	11.03-					
35.480 FFNHLK HH4	11.06-					
35.480 FFNLC H90	07.06-					
35.480 FFNLC H88	07.06-					
35.530 FDNLC H91	04.04-					

TGA		03.00 -					
35.530 FFDK H73	07.06-	D2866LF26, D2866LF27, D2676LF04, D2866LF28, D2876LF07, D2676LF13, D2676LF14, D2676LF05, D2876LF12, D2676LF02, D2676LF01, D2676LF12, D2876LF25, D2676LF11, D2876LF04, D2876LF13, D2676LF03		3400 700 402 ⊗ 3482 000 246 ⊗ 1878 002 139 ⊙ 3151 000 034	430 10 MFZ430 430WGTZ KZISZ-5	Getr. / GBox: ZF Ecosplit-3	
35.530 FFDK H76	07.06-			3400 700 460 HD ⊗ 3482 000 246 ⊗ 1878 004 104 ⊙ 3151 000 034	430 10 MFZ430 430WGTZ KZISZ-5	Getr. / GBox: ZF Ecosplit-3	
35.530 FFDC, FFDLC H40 H36	04.04-			3400 700 404 ⊗ 3482 000 246 ⊗ 1878 002 139 ⊙ 3151 000 144	430 10 MFZ430 430WGTZ KZISZ-5	Getr. / GBox: AS-Tronic	
35.530 FFDK, FFDLK H36 H40	04.04-			3400 700 445 ⊗ 3482 000 246 ⊗ 1878 002 139 ⊙ 3151 000 493	430 10 MFZ430 430WGTZ KZISZ-5	Getr. / GBox: AS-Tronic für Ausrückgabel mit Rollen / for release fork with rollers	(70)
35.530 FFD-TM H36	04.04-			3400 700 459 HD ⊗ 3482 000 246 ⊗ 1878 004 104 ⊙ 3151 000 493	430 10 MFZ430 430WGTZ KZISZ-5	Getr. / GBox: AS-Tronic für Ausrückgabel mit Rollen / for release fork with rollers	(70)
35.530 FFNLC H88	07.06-			3400 700 327 ⊗ 3482 114 031 ⊗ 1878 004 832 ⊙ 3151 263 031	430 10 GMFZ430N 430WGTZ KZISZ-6	Getr. / GBox: ZF 16S-151/181 für Fahrzeuge mit Nebenantrieb / for vehicles with PTO	(73)
37.460 FFD-TM H38	12.04-			3496 006 000		langer Bügel / long handle	(86)
37.460 FFDK H38	12.04-			1863 869 038			
37.460 FFDK H38	12.04-						
37.460 FFDK H39	12.04-						
37.480 FFDK H38	12.04-						
37.480 FFDK H39	02.06-						
37.480 FFDK H38	12.04-						
37.480 FFDK H39	02.06-						
37.480 FFDK H38	12.04-						
37.530 FFD-TM H38	12.04-						
37.530 FFDK H38	12.04-						
37.530 FFDK H38	12.04-						
37.530 FVDLS H69	07.06-						
39.480 FVNLC H58	06.05-						
40.440 FDK-WW, FDRK H34 H11	06.05-						
40.440 FDS-WW, FDRS H34	06.05-						
40.460 FDK-WW H57	04.04-						
40.460 FDK-WW H57	04.04-						
40.460 FDK-WW H33	04.04-						
40.460 FDS-WW H33	04.04-						
40.480 FDK-WW H58	06.05-						
40.480 FDK-WW H57	04.04-						
40.480 FDK-WW H58	06.05-						
40.480 FDK-WW H58 H57	04.04-						
40.480 FDK-WW H33	04.04-						











		CODE				
--	--	------	--	---	---	---

MAN

TGA		03.00 -				
40.480 FDK-WW, FDRK H34 H11	06.05-	D2866LF26, D2866LF27, D2676LF04, D2866LF28,	 3400 700 402 ⊗ 3482 000 246 ⊗ 1878 002 139 ⊙ 3151 000 034	430 10 MFZ430 430WGTZ KZISZ-5	Getr. / GBox: ZF Ecosplit-3	
40.480 FDS-WW H33	04.04-	D2876LF07, D2676LF13, D2676LF14, D2676LF05, D2876LF12, D2676LF02, D2676LF01, D2676LF12, D2876LF25, D2676LF11, D2876LF04, D2876LF13, D2676LF03	 3400 700 460 HD ⊗ 3482 000 246 ⊗ 1878 004 104 ⊙ 3151 000 034	430 10 MFZ430 430WGTZ KZISZ-5	Getr. / GBox: ZF Ecosplit-3	
41.440 FFD/M HW6	12.04-					
41.440 FFDC, FFDRK HW3 HW6	12.04-					
41.440 FFDC-TM, FFDRK-TM HW3	09.07-					
41.440 FFDK, FFDRK HW3 HW6	12.04-					
41.460 FFD-TM H38	12.04-					
41.460 FFDC-WW, FFDRK H46 H38	09.03-					
41.460 FFDK-WW H38 H46	09.03-					
41.480 FFD HW6	12.08-					
41.480 FFD-TM H39 HW6	02.06-					
41.480 FFD-TM H38	12.04-					
41.480 FFDAK H73	07.06-					
41.480 FFDAK H76	07.06-					
41.480 FFDAK HV6 H96	07.06-					
41.480 FFDAK H93	07.06-					
41.480 FFDARC H76	07.06-					
41.480 FFDC, FFDRK, FFDC/M HW3 HW6 H39	02.06-					
41.480 FFDC-TM, FFDRK-TM HW3	09.07-					
41.480 FFDC-WW, FFDRK H46 H38	06.05-					
41.480 FFDK, FFDRK HW6 H39 HW3	02.06-					
41.480 FFDK-WW H38 H46	06.05-					
41.480 FVDS, FVDLS H94	07.06-					
41.530 FFD-TM H38	12.04-					
41.530 FFDAK H76	07.06-					
41.530 FFDAK H73	07.06-					
41.530 FFDAK H76	07.06-					
41.530 FFDC H38	12.04-					
41.530 FFDK H38	12.04-					
41.540 FVDS, FVDLS H94	11.06-					
			 3400 700 455 ⊗ 3482 000 246 ⊗ 1878 002 139 ⊙ 3151 000 493	430 10 MFZ430 430WGTZ KZISZ-5	Getr. / GBox: AS-Tronic für Ausrückgabel mit Rollen / for release fork with rollers	(70)
			 3400 700 459 HD ⊗ 3482 000 246 ⊗ 1878 004 104 ⊙ 3151 000 493	430 10 MFZ430 430WGTZ KZISZ-5	Getr. / GBox: AS-Tronic für Ausrückgabel mit Rollen / for release fork with rollers	(70)
			 3400 700 327 ⊗ 3482 114 031 ⊗ 1878 004 832 ⊙ 3151 263 031	430 10 GMFZ430N 430WGTZ KZISZ-6	Getr. / GBox: ZF 16S-151/181 für Fahrzeuge mit Nebenantrieb / for vehicles with PTO	(73)
			 3496 006 000		langer Bügel / long handle	(82)
			 1863 869 038			(86)













		CODE				
--	--	------	--	---	---	---

MAN

TGA		03.00 -				
D2876LF07, D2876LF05, D2876LF12, D2876LF25, D2876LF13, D2876LF04	18.460 FC, FLC, FRC, FLLC, FLLC/N, FLLW, FLLRC, FLLRW H02 H05 H09 H14	04.00-	 3400 700 402 ⊗ 3482 000 246 ⊗ 1878 002 139 ⊙ 3151 000 034	430 10 MFZ430 430WGTZ KZISZ-5	Getr. / GBox: ZF Ecosplit-3 Getr. / GBox: Eaton	
	18.460 FK, FK-L, FLK, FLRK H02 H05	12.00-	 3400 700 460 HD ⊗ 3482 000 246 ⊗ 1878 004 104 ⊙ 3151 000 034	430 10 MFZ430 430WGTZ KZISZ-5	Getr. / GBox: ZF Ecosplit-3 Getr. / GBox: Eaton	
	18.460 FLS, FLLS, FLLS/N, FLS-TS, FLRS, FLLRS H01 H09 H05 H12 H61	04.00-	 3488 017 447	400 MFZ2/400X	Getr. / GBox: ZF Ecosplit-3 für Fahrzeuge mit Zweischeibenkupplung / for vehicles with double disc clutch enthält eine Kupplungsscheibe / This part number includes one clutch disc	(77) (66)
	18.480 FC, FLC, FLLC, FLLW, FLLRW, FLLRC H02 H14 H09 H05	09.02-	 1878 002 643	400 10 400WGTZ	Getr. / GBox: ZF Ecosplit-3 für Fahrzeuge mit Zweischeibenkupplung / for vehicles with double disc clutch	(77)
	18.480 FK, FLK, FK-L H05 H02	09.02-	 3151 262 031	KZISZ-5	Getr. / GBox: ZF Ecosplit-3 für Fahrzeuge mit Zweischeibenkupplung / for vehicles with double disc clutch	(77)
	18.480 FLS, FLLS, FLLS/N, FLS-TS, FLRS-WW H12 H01 H05 H09 H61	09.02-	 3400 700 327 ⊗ 3482 114 031 ⊗ 1878 004 832 ⊙ 3151 263 031	430 10 GMFZ430N 430WGTZ KZIZ-6	Getr. / GBox: ZF 16S-151/181 für Fahrzeuge mit Nebenantrieb / for vehicles with PTO	(73) (82)
	18.510 FC, FLC, FRC, FLLC, FLLC/N, FLLW, FLLRC, FLLRW H02 H14 H05 H09	09.00-	 3400 700 404 ⊗ 3482 000 246 ⊗ 1878 002 139 ⊙ 3151 000 144	430 10 MFZ430 430WGTZ KZISZ-5	Getr. / GBox: AS-Tronic	
	18.510 FLS, FLLS, FLLS/N, FLRS, FLLRS H09 H05 H12	04.00-	 3400 700 445 ⊗ 3482 000 246 ⊗ 1878 002 139 ⊙ 3151 000 493	430 10 MFZ430 430WGTZ KZISZ-5	Getr. / GBox: AS-Tronic für Ausrückgabel mit Rollen / for release fork with rollers	(70)
	18.530 FC, FLC, FLLC, FLLC/N, FLLW, FLLRC, FLLRW H02 H05 H14 H09	09.02-	 3400 700 459 HD ⊗ 3482 000 246 ⊗ 1878 004 104 ⊙ 3151 000 493	430 10 MFZ430 430WGTZ KZISZ-5	Getr. / GBox: AS-Tronic für Ausrückgabel mit Rollen / for release fork with rollers	(70)
	18.530 FLS, FLLS, FLLS/N H09 H05 H12	09.02-	 3496 006 000		langer Bügel / long handle	(86)
	26.460 FPLS, FPLRS, FVLS, FVLR, FNLS, FNLLS, FNLRS H17 H20 H23	12.00-				
	26.460 FVLC H23	02.01-				
	26.460 FVL-KO H23	12.00-				
	26.480 FNLC, FNLLC, FVLC, FNLLRC, FVLLW H17 H20 H23	09.02-				
	26.480 FNLS, FNLLS, FNLRS, FPLS, FVLS H20 H17 H23	09.02-				
26.480 FVL-KO H23	09.02-					
26.510 FNLS, FNLLS, FNLRS, FPLS, FVLS H17 H23 H20	12.00-					
26.530 FNLC, FNLLC, FNLLW, FNLLRC, FVLC, FVLR H20 H17 H23	09.02-					
26.530 FNLS, FNLLS, FNLRS, FPLS, FVLS, FVLR H23 H17 H20	09.02-					









		CODE				
--	--	------	--	---	---	---

MAN

TGA		03.00 -						
18.480 FAC, FARC H51	09.02-	D2876LF05, D2876LF12, D2876LF25, D2876LF04, D2876LF13	 3400 700 402 ⊗ 3482 000 246 ⊗ 1878 002 139 ⊙ 3151 000 034	430 10 MFZ430 430WGTZ KZISZ-5				
18.480 FAK, FAK-L, FALK H51 H70	09.02-		 3400 700 460 HD ⊗ 3482 000 246 ⊗ 1878 004 104 ⊙ 3151 000 034	430 10 MFZ430 430WGTZ KZISZ-5				
18.480 FAS, FALS, FARS H51 H70	09.02-		 3400 700 404 ⊗ 3482 000 246 ⊗ 1878 002 139 ⊙ 3151 000 144	430 10 MFZ430 430WGTZ KZISZ-5	Getr. / GBox: AS-Tronic			
24.460 FNLLC/N, FNLLW, FNLLRC, FNLLRW H44	09.01-		 3400 700 445 ⊗ 3482 000 246 ⊗ 1878 002 139 ⊙ 3151 000 493	430 10 MFZ430 430WGTZ KZISZ-5	Getr. / GBox: AS-Tronic für Ausrückgabel mit Rollen / for release fork with rollers			(70)
24.480 FNLLC/N, FNLLW, FNLLRC, FNLLRW H44	09.02-		 3400 700 459 HD ⊗ 3482 000 246 ⊗ 1878 004 104 ⊙ 3151 000 493	430 10 MFZ430 430WGTZ KZISZ-5	Getr. / GBox: AS-Tronic für Ausrückgabel mit Rollen / for release fork with rollers			(70)
24.510 FNLLC/N, FNLLW, FNLLRW H44	09.01-							
24.530 FNLLC/N, FNLLW, FNLLRW H44	09.01-							
26.480 FDAC, FDALC, FDARC H72 H55	09.02-							
26.480 FDAK, FDALK H55 H72	09.02-							
26.480 FDAS, FDALS, FDARS H55 H72	09.02-							
32.460 FFDK, FFDLC, FFDLRC H36 H40	01.02-							
32.460 FFDK, FFDLC H40 H36	01.02-							
32.460 FFD-TM H36 H48	01.02-							
32.480 FFDK, FFDLC, FFDLRC H40 H36	09.02-							
32.480 FFDK, FFDLC H36 H40	09.02-							
32.480 FFD-TM H36 H48	09.02-							
33.480 FDAC, FDAC-WW, FDALC, FDARC H72 H54 H55	09.02-							
33.480 FDAK, FDAK-WW, FDALK H54 H55 H72	09.02-							
33.480 FDAS, FDAS-WW, FDARS, FDALS H54 H72 H55	09.02-							
33.530 FDAK, FDALK H55 H72	09.02-							
33.530 FDAS, FDALS H55 H72	09.02-							
26.280 FNLC, FNLLC, FNLLW H19 H16	11.02-	D0836LF44, D0836LF41	 3400 121 701 ⊗ 3482 000 467 ⊗ 1862 506 131 ⊙ 3151 253 031	395 10 MFZ395 395WGTZ KZIZ-4,5	Getr. / GBox: EATON FS/FSO-8309			
26.330 FNLC, FNLLC, FNLLW H16 H19	11.02-		 3496 006 000		Getr. / GBox: EATON FS/FSO-8309 langer Bügel / long handle			(86)
			 3482 000 546	395 MFZ395	Getr. / GBox: 12AS-1210TO Getr. / GBox: AS-Tronic			
			 1862 506 131	395 10 395WGTZ	Getr. / GBox: 12AS-1210TO Getr. / GBox: AS-Tronic			
			 3151 000 144	KZISZ-5	Getr. / GBox: 12AS-1210TO Getr. / GBox: AS-Tronic für Ausrückgabel mit Nocken / for release fork with cams			(69)
			 3400 700 364 ⊗ 3482 000 546 ⊗ 1862 506 131 ⊙ 3151 000 493	395 10 MFZ395 395WGTZ KZISZ-5	Getr. / GBox: 12AS-1210TO Getr. / GBox: AS-Tronic für Ausrückgabel mit Rollen / for release fork with rollers			(70)
			 3400 700 396	395 10	Getr. / GBox: ZF-9S-1310TO			

		CODE				
--	--	------	--	---	---	---

MAN

















TGA		03.00 -					
26.310 FNLC, FNLLC, FVLC, FNLLW, FNLRC, FNLLRW H23 H17 H20	09.00-	D2866LF26, D2866LF27, D2866LF28, D2866LF36, D2866LF37		3400 127 401 ⊗ 3482 000 361 ⊗ 1878 004 832 ⊙ 3151 000 034	430 10 MFZ430 430WGTZ KZISZ-5	Getr. / GBox: ZF Ecosplit-3	
26.360 FNLC, FNLLC, FNLLW, FNLLRC, FNLLRW, FVLC H20 H17 H23	09.00-			3488 017 447	400 MFZ2/400X	Getr. / GBox: ZF Ecosplit-3 für Fahrzeuge mit Zweischeibenkupplung / for vehicles with double disc clutch enthält eine Kupplungsscheibe / This part number includes one clutch disc	(77)
28.310 FNLC, FNLLC, FNLRC H87 H86	09.02-						(66)
28.310 FNLS, FNLRS H86	09.02-			1878 002 643	400 10 400WGTZ	Getr. / GBox: ZF Ecosplit-3 für Fahrzeuge mit Zweischeibenkupplung / for vehicles with double disc clutch	(77)
28.360 FNLC, FNLLC H87 H86	09.02-						
28.360 FNLS, FNLRS H86	09.02-			3151 262 031	KZISZ-5	Getr. / GBox: ZF Ecosplit-3 für Fahrzeuge mit Zweischeibenkupplung / for vehicles with double disc clutch	(77)
28.410 FNLC, FNLLC, FNLRC H86 H87	09.02-			3400 700 403 ⊗ 3482 000 361 ⊗ 1878 004 832 ⊙ 3151 000 144	430 10 MFZ430 430WGTZ KZISZ-5	Getr. / GBox: ZF AS-Tronic für Ausrückgabel mit Nocken / for release fork with cams	(69)
28.410 FNLS, FNLRS H86	09.02-			3400 700 450 ⊗ 3482 000 361 ⊗ 1878 004 832 ⊙ 3151 000 493	430 10 MFZ430 430WGTZ KZISZ-5	Getr. / GBox: ZF AS-Tronic für Ausrückgabel mit Rollen / for release fork with rollers	(70)
				3400 700 327 ⊗ 3482 114 031 ⊗ 1878 004 832 ⊙ 3151 263 031	430 10 GMFZ430N 430WGTZ KZIZ-6	Getr. / GBox: ZF 16S-151/181 für Fahrzeuge mit Nebenantrieb / for vehicles with PTO für Nebenantrieb / for PTO	(73) (82)
			3496 006 000		langer Bügel / long handle	(86)	



MAN





























TGA 03.00 -

<p>26.310, 26.320 FDC, FDRC, FDC/M, FDRC/M, FDLC, FNHLC, FVHLC H35 H42 H30 H26</p> <p>26.310, 26.320 FDK, FDLK H30 H26</p> <p>26.310, 26.320 FDS, FDS/M, FDLS, FDRS, FDRS/M, FNHLS, FDLRS H26 H35 H30</p> <p>26.310, 26.320 FD-TM H26</p> <p>26.350, 26.360 FDC, FDRC, FDC/M, FDRC/M, FDLC, FDLRC, FNHLC H30 H42 H67 H35 H26</p> <p>26.350, 26.360 FDK, FDLK, FDRK H26 H30</p> <p>26.350, 26.360 FDS, FDS/M, FDLS, FDRS, FNHLS, FPHLS H26 H30 H35 H67 H42 HV2</p> <p>26.350, 26.360 FD-TM H26</p> <p>26.390, 26.400 FDC, FDRC, FDLRC, FDRC/M, FDLC, FNHLC, FVHLC H30 H42 H26 H35 H67</p> <p>26.390, 26.400 FDK, FDLK H26 H30</p> <p>26.390, 26.400 FDS, FDS/M, FDLS, FDLRS, FNHLS, FPHLS, FVHLS H26 H30 H67 HV2 H35 H42</p> <p>26.390, 26.400 FD-TM H26</p> <p>33.350, 33.360 FDC, FDC/M, FDLC, FDRC H30 H26 HW2 H66</p> <p>33.350, 33.360 FDK, FDLK, FDRK H30 H66 HW2 H26</p> <p>33.350, 33.360 FDS, FDLS, FDS/M, FDRS H26 H30 HV2 H66 HW2</p> <p>33.390, 33.400 FDC, FDLC, FDRC, FDC/M H26 HW2 H30 H66</p> <p>33.390, 33.400 FDK, FDLK, FDRK H30 H66 H26 HW2</p> <p>33.390, 33.400 FDS, FDLS, FDLRS, FDRS, FDS/M H26 HV2 HW2 HW8 HW9 H30 H66</p>	<p>05.04 -</p> <p>05.04 -</p> <p>05.04 -</p> <p>06.05 -</p> <p>05.04 -</p> <p>05.04 -</p> <p>05.04 -</p> <p>02.04 -</p> <p>05.04 -</p> <p>05.04 -</p> <p>05.04 -</p> <p>05.04 -</p> <p>05.04 -</p> <p>05.04 -</p> <p>05.04 -</p> <p>05.04 -</p> <p>05.04 -</p> <p>05.04 -</p> <p>05.04 -</p> <p>05.04 -</p> <p>05.04 -</p> <p>05.04 -</p> <p>05.04 -</p> <p>05.04 -</p> <p>05.04 -</p>	<p>D2066LF37, D2066LF39, D2066LF03, D2066LF33, D2066LF02, D2066LF07, D2066LF35, D2066LF12, D2066LF14, D2066LF32, D2066LF13, D2066LF06, D2066LF04, D2066LF38</p>	<p> 3400 700 380 3482 000 361 1878 080 037 3151 000 034</p> <p> 3488 017 447</p> <p> 1878 002 643</p> <p> 3151 262 031</p> <p> 3482 000 361</p> <p> 1878 080 037</p> <p> 3151 000 144</p> <p> 3400 700 381 3482 000 361 1878 080 037 3151 000 493</p> <p> 3400 700 327 3482 114 031 1878 004 832 3151 263 031</p> <p> 3496 006 000</p>	<p>430 10 MFZ430 430WGTZ KZISZ-5</p> <p>400 MFZ2/400X</p> <p>400 10 400WGTZ</p> <p>430 MFZ430</p> <p>430 10 430WGTZ</p> <p>430 10 KZISZ-5</p> <p>430 10 MFZ430 430WGTZ KZISZ-5</p> <p>430 10 GMFZ430N 430WGTZ KZIZ-6</p>	<p>Getr. / GBox: ZF-Ecosplit-3 H26,H30,H42</p> <p>Getr. / GBox: ZF-Ecosplit-3 H26,H30,H42 für Fahrzeuge mit Zweischeibenkupplung / for vehicles with double disc clutch enthält eine Kupplungsscheibe / This part number includes one clutch disc</p> <p>Getr. / GBox: ZF-Ecosplit-3 H26,H30,H42 für Fahrzeuge mit Zweischeibenkupplung / for vehicles with double disc clutch</p> <p>Getr. / GBox: ZF-Ecosplit-3 H26,H30,H42</p> <p>Getr. / GBox: AS-Tronic H26,H30,H42</p> <p>Getr. / GBox: AS-Tronic H26,H30,H42</p> <p>Getr. / GBox: AS-Tronic H26,H30,H42 für Ausrückgabel mit Nocken / for release fork with cams</p> <p>Getr. / GBox: AS-Tronic H26,H30,H42 für Ausrückgabel mit Rollen / for release fork with rollers</p> <p>Getr. / GBox: ZF 16S-151/181 H26,H30,H42 für Fahrzeuge mit Nebenantrieb / for vehicles with PTO für Nebenantrieb / for PTO</p> <p>H26,H30,H42 langer Bügel / long handle</p>	<p></p> <p>(77)</p> <p>(66)</p> <p>(77)</p> <p>(77)</p> <p></p> <p></p> <p>(69)</p> <p>(70)</p> <p>(73)</p> <p>(82)</p> <p>(86)</p>
--	--	---	--	--	--	---

TGA		03.00 -				
26.310, 26.320 FNLC, FNLLC, FNLRC, FNLLRC, FNLLW H21 H18 26.310, 26.320 FNLS, FNLLS, FNLRS, FNLLRS H21 H18 26.310, 26.320 FVHL-KO H42 26.350, 26.360 FNLC, FNLLC, FNLLW, FNLRC, FNLLRC H21 H18 HV1 26.350, 26.360 FNLS, FNLLS, FNLRS, FNLLRS, FPLS, FPLRS HV1 H24 H21 H18 26.350, 26.360 FVHL-KO H42 26.390, 26.400 FNLC, FNLLC, FNLLW, FNLRC, FNLLRC H21 HV1 H18 26.390, 26.400 FNLS, FNLLS, FNLRS, FNLLRS, FPLS, FPLRS H18 HV1 H21 H24 26.390, 26.400 FVHL-KO H42	05.04 -	D2066LF28, D2066LF27, D2066LF37, D2066LF39, D2066LF03, D2066LF33, D2066LF02, D2066LF26, D2066LF35, D2066LF12, D2066LF14, D2066LF32, D2066LF13, D2066LF04, D2066LF38, D2066LF24	 3400 700 380 ⚙️ 3482 000 361 ⚙️ 1878 080 037 ⚙️ 3151 000 034	430 10 MFZ430 430WGTZ KZISZ-5	Getr. / GBox: ZF-Ecosplit-3 H18,H42	
	05.04 -		 3488 017 447	400 MFZ2/400X	Getr. / GBox: ZF-Ecosplit-3 H18,H42 für Fahrzeuge mit Zweischeibenkupplung / for vehicles with double disc clutch enthält eine Kupplungsscheibe / This part number includes one clutch disc	(77)
	06.05 -					(66)
	05.04 -		 1878 002 643	400 10 400WGTZ	Getr. / GBox: ZF-Ecosplit-3 H18,H42 für Fahrzeuge mit Zweischeibenkupplung / for vehicles with double disc clutch	(77)
	05.04 -		 3151 262 031	KZISZ-5	Getr. / GBox: ZF-Ecosplit-3 H18,H42 für Fahrzeuge mit Zweischeibenkupplung / for vehicles with double disc clutch	(77)
	06.05 -					
	05.04 -		 3482 000 361	430 MFZ430	Getr. / GBox: AS-Tronic H18,H42	
	05.04 -		 1878 080 037	430 10 430WGTZ	Getr. / GBox: AS-Tronic H18,H42	
	05.04 -		 3151 000 144	KZISZ-5	Getr. / GBox: AS-Tronic H18,H42 für Ausrückgabel mit Nocken / for release fork with cams	(69)
	06.05 -		 3400 700 381 ⚙️ 3482 000 361 ⚙️ 1878 080 037 ⚙️ 3151 000 493	430 10 MFZ430 430WGTZ KZISZ-5	Getr. / GBox: AS-Tronic H18,H42 für Ausrückgabel mit Rollen / for release fork with rollers	(70)
			 3400 700 327 ⚙️ 3482 114 031 ⚙️ 1878 004 832 ⚙️ 3151 263 031	430 10 GMFZ430N 430WGTZ KZISZ-6	Getr. / GBox: ZF 16S-151/181 H18,H42 für Fahrzeuge mit Nebenantrieb / for vehicles with PTO für Nebenantrieb / for PTO	(73) (82)
			 3496 006 000		H18,H42 langer Bügel / long handle	(86)
	26.400 FVLC H24		04.06 -	D2066LF37	 3400 700 380 ⚙️ 3482 000 361 ⚙️ 1878 080 037 ⚙️ 3151 000 034	430 10 MFZ430 430WGTZ KZISZ-5
 3482 000 361		430 MFZ430			Getr. / GBox: AS-Tronic	
 1878 080 037		430 10 430WGTZ			Getr. / GBox: AS-Tronic	
 3151 000 144		KZISZ-5			Getr. / GBox: AS-Tronic für Ausrückgabel mit Nocken / for release fork with cams	(69)
 3400 700 381 ⚙️ 3482 000 361 ⚙️ 1878 080 037 ⚙️ 3151 000 493		430 10 MFZ430 430WGTZ KZISZ-5			Getr. / GBox: AS-Tronic für Ausrückgabel mit Rollen / for release fork with rollers	(70)
 3400 700 327 ⚙️ 3482 114 031 ⚙️ 1878 004 832 ⚙️ 3151 263 031		430 10 GMFZ430N 430WGTZ KZISZ-6			Getr. / GBox: ZF 16S-151/181 für Fahrzeuge mit Nebenantrieb / for vehicles with PTO für Nebenantrieb / for PTO	(73) (82)
 3496 006 000		langer Bügel / long handle	(86)			











		CODE				
--	--	------	--	---	---	---

MAN

TGA		03.00 -				
26.430, 26.440 FDC, FDRC, FDLC, FDLRC, FDLC/M, FNHLC, FVHLC H26 H42 H67 H30 H35 26.430, 26.440 FDS, FDLS, FDRS, FDLRS, FNHLS, FPHLS, FVHLS H35 HV2 H42 H30 H26 H67 26.480 FDC, FDC/M, FDLC, FDLRC, FDRC, FNHLC, FVHLC, FDLRC-WW H35 H26 H67 H30 H42 26.480 FDS, FDLS, FDLRS, FNHLS, FPHLS, FVHLS HV2 H35 H67 H30 H42 H26	05.04-	D2066LF11, D2066LF31, D2066LF23, D2066LF01, D2066LF36, D2676LF05, D2676LF01, D2676LF02, D2676LF03	 3400 700 402  3482 000 246  1878 002 139  3151 000 034	430 10 MFZ430 430WGTZ KZISZ-5	Getr. / GBox: ZF-Ecosplit-3 H26,H30,H42	
	02.04-		 3400 700 460 HD  3482 000 246  1878 004 104  3151 000 034	430 10 MFZ430 430WGTZ KZISZ-5	Getr. / GBox: ZF-Ecosplit-3 H26,H30,H42	
	02.06-		 3488 017 447	400 MFZ2/400X	Getr. / GBox: ZF-Ecosplit-3 H26,H30,H42 für Fahrzeuge mit Zweischeibenkupplung / for vehicles with double disc clutch enthält eine Kupplungsscheibe / This part number includes one clutch disc	(77) (66)
	02.06-		 1878 002 643	400 10 400WGTZ	Getr. / GBox: ZF-Ecosplit-3 H26,H30,H42 für Fahrzeuge mit Zweischeibenkupplung / for vehicles with double disc clutch	(77)
			 3151 262 031	KZISZ-5	Getr. / GBox: ZF-Ecosplit-3 H26,H30,H42 für Fahrzeuge mit Zweischeibenkupplung / for vehicles with double disc clutch	(77)
			 3400 700 404  3482 000 246  1878 002 139  3151 000 144	430 10 MFZ430 430WGTZ KZISZ-5	Getr. / GBox: AS-Tronic H26,H30,H42	
			 3400 700 445  3482 000 246  1878 002 139  3151 000 493	430 10 MFZ430 430WGTZ KZISZ-5	Getr. / GBox: AS-Tronic H26,H30,H42 für Ausrückgabel mit Rollen / for release fork with rollers	(70)
			 3400 700 459 HD  3482 000 246  1878 004 104  3151 000 493	430 10 MFZ430 430WGTZ KZISZ-5	Getr. / GBox: AS-Tronic H26,H30,H42 für Ausrückgabel mit Rollen / for release fork with rollers	(70)
			 3400 700 327  3482 114 031  1878 004 832  3151 263 031	430 10 GMFZ430N 430WGTZ KZISZ-6	Getr. / GBox: ZF 16S-151/181 H26,H30,H42 für Fahrzeuge mit Nebenantrieb / for vehicles with PTO für Nebenantrieb / for PTO	(73) (82)
			 3496 006 000		H26,H30,H42 langer Bügel / long handle	(86)





























		CODE		 Parameter		
--	--	------	--	---	---	---

MAN

TGA		03.00 -				
26.430, 26.440 FDK, FDLK H26 H30 26.480 FDK, FDLK H26 H30	05.04 -	D2066LF11, D2066LF31, D2066LF01, D2066LF36, D2676LF05, D2676LF01	 3400 700 402 ⊗ 3482 000 246 ⊗ 1878 002 139 ⊙ 3151 000 034	430 10 MFZ430 430WGTZ KZISZ-5	Getr. / GBox: ZF-Ecosplit-3 H26,H30	
	02.06 -		 3400 700 460 HD ⊗ 3482 000 246 ⊗ 1878 004 104 ⊙ 3151 000 034	430 10 MFZ430 430WGTZ KZISZ-5	Getr. / GBox: ZF-Ecosplit-3 H26,H30	
			 3488 017 447	400 MFZ2/400X	Getr. / GBox: ZF-Ecosplit-3 H26,H30 für Fahrzeuge mit Zweischeibenkupplung / for vehicles with double disc clutch enthält eine Kupplungsscheibe / This part number includes one clutch disc	(77) (66)
			 1878 002 643	400 10 400WGTZ	Getr. / GBox: ZF-Ecosplit-3 H26,H30 für Fahrzeuge mit Zweischeibenkupplung / for vehicles with double disc clutch	(77)
			 3151 262 031	KZISZ-5	Getr. / GBox: ZF-Ecosplit-3 H26,H30 für Fahrzeuge mit Zweischeibenkupplung / for vehicles with double disc clutch	(77)
			 3400 700 404 ⊗ 3482 000 246 ⊗ 1878 002 139 ⊙ 3151 000 144	430 10 MFZ430 430WGTZ KZISZ-5	Getr. / GBox: AS-Tronic H26,H30	
			 3400 700 445 ⊗ 3482 000 246 ⊗ 1878 002 139 ⊙ 3151 000 493	430 10 MFZ430 430WGTZ KZISZ-5	Getr. / GBox: AS-Tronic H26,H30 für Ausrückgabel mit Rollen / for release fork with rollers	(70)
			 3400 700 459 HD ⊗ 3482 000 246 ⊗ 1878 004 104 ⊙ 3151 000 493	430 10 MFZ430 430WGTZ KZISZ-5	Getr. / GBox: AS-Tronic H26,H30 für Ausrückgabel mit Rollen / for release fork with rollers	(70)
			 3400 700 327 ⊗ 3482 114 031 ⊗ 1878 004 832 ⊙ 3151 263 031	430 10 GMFZ430N 430WGTZ KZISZ-6	Getr. / GBox: ZF 16S-151/181 H26,H30 für Fahrzeuge mit Nebenantrieb / for vehicles with PTO für Nebenantrieb / for PTO	(73) (82)
			 3496 006 000		H26,H30 langer Bügel / long handle	(86)





























		CODE				
--	--	------	--	---	---	---

MAN

TGA		03.00 -				
26.430, 26.440 FD-TM H26 26.480 FD-TM H26 33.430, 33.440 FDC, FDLC, FDRC, FDLRC, FDC/M H30 HW2 H26 H66 33.430, 33.440 FDK, FDLK, FDRK H66 HW2 H26 H30 33.430, 33.440 FDS, FDLS, FDRS, FDLRS, FDS/M HW8 HW2 H66 H26 H30 HV2 33.480 FDC, FDLC, FDRC, FDC/M H66 H26 HW2 H30 33.480 FDK, FDLK, FDRK H30 HW2 H26 H66 33.480 FDS, FDRS, FDLS, FDS/M H30 HW9 HV2 H66 HW2 H26 HW8	05.04 -	D2066LF11, D2066LF31, D2676LF05, D2066LF01, D2066LF36, D2676LF01, D2676LF02, D2676LF03	 3400 700 402  3482 000 246  1878 002 139  3151 000 034	430 10 MFZ430 430WGTZ KZISZ-5	Getr. / GBox: ZF-Ecosplit-3 H26	
	02.06 -		 3400 700 460 HD  3482 000 246  1878 004 104  3151 000 034	430 10 MFZ430 430WGTZ KZISZ-5	Getr. / GBox: ZF-Ecosplit-3 H26	
	05.04 -		 3488 017 447	400 MFZ2/400X	Getr. / GBox: ZF-Ecosplit-3 H26 für Fahrzeuge mit Zweischeibenkupplung / for vehicles with double disc clutch enthält eine Kupplungsscheibe / This part number includes one clutch disc	(77) (66)
	05.04 -		 1878 002 643	400 10 400WGTZ	Getr. / GBox: ZF-Ecosplit-3 H26 für Fahrzeuge mit Zweischeibenkupplung / for vehicles with double disc clutch	(77)
	01.06 -		 3151 262 031	KZISZ-5	Getr. / GBox: ZF-Ecosplit-3 H26 für Fahrzeuge mit Zweischeibenkupplung / for vehicles with double disc clutch	(77)
	01.06 -		 3400 700 404  3482 000 246  1878 002 139  3151 000 144	430 10 MFZ430 430WGTZ KZISZ-5	Getr. / GBox: AS-Tronic H26	
			 3400 700 445  3482 000 246  1878 002 139  3151 000 493	430 10 MFZ430 430WGTZ KZISZ-5	Getr. / GBox: AS-Tronic H26 für Ausrückgabel mit Rollen / for release fork with rollers	(70)
			 3400 700 459 HD  3482 000 246  1878 004 104  3151 000 493	430 10 MFZ430 430WGTZ KZISZ-5	Getr. / GBox: AS-Tronic H26 für Ausrückgabel mit Rollen / for release fork with rollers	(70)
			 3400 700 327  3482 114 031  1878 004 832  3151 263 031	430 10 GMFZ430N 430WGTZ KZISZ-6	Getr. / GBox: ZF 16S-151/181 H26 für Fahrzeuge mit Nebenantrieb / for vehicles with PTO für Nebenantrieb / for PTO	(73) (82)
			 3496 006 000		H26 langer Bügel / long handle	(86)











		CODE				
--	--	------	--	---	---	---

MAN

TGA		03.00 -				
26.430, 26.440, FNLC, FNLLC, FNLLW, FNLRC, FNLLRC, FVLC H18 H24 H21 HV1 26.430, 26.440, FNLS, FNLLS, FNLRs, FNLLRS, FPLS, FPLRS H24 H18 H21 HV1 26.480 FNLC, FNLRc-WW, FNLLC, FNLLRC, FNLLW, FVLC H18 H21 H24 HV1 26.480 FNLS, FNLLS, FNLRs, FPLS, FVLS, FVLRs H18 HV1 H21 H24	05.04-	D2676LF14, D2066LF11, D2066LF31, D2066LF23, D2066LF25, D2676LF05, D2066LF01, D2066LF36, D2676LF01, D2676LF02, D2676LF12	 3400 700 402  3482 000 246  1878 002 139  3151 000 034	430 10 MFZ430 430WGTZ KZISZ-5	Getr. / GBox: ZF-Ecosplit-3 H18	
	05.04-		 3400 700 460 HD  3482 000 246  1878 004 104  3151 000 034	430 10 MFZ430 430WGTZ KZISZ-5	Getr. / GBox: ZF-Ecosplit-3 H18	
	02.06-		 3488 017 447	400 MFZ2/400X	Getr. / GBox: ZF-Ecosplit-3 H18 für Fahrzeuge mit Zweischeibenkupplung / for vehicles with double disc clutch enthält eine Kupplungsscheibe / This part number includes one clutch disc	(77) (66)
	02.06-		 1878 002 643	400 10 400WGTZ	Getr. / GBox: ZF-Ecosplit-3 H18 für Fahrzeuge mit Zweischeibenkupplung / for vehicles with double disc clutch	(77)
			 3151 262 031	KZISZ-5	Getr. / GBox: ZF-Ecosplit-3 H18 für Fahrzeuge mit Zweischeibenkupplung / for vehicles with double disc clutch	(77)
			 3400 700 404  3482 000 246  1878 002 139  3151 000 144	430 10 MFZ430 430WGTZ KZISZ-5	Getr. / GBox: AS-Tronic H18	
			 3400 700 445  3482 000 246  1878 002 139  3151 000 493	430 10 MFZ430 430WGTZ KZISZ-5	Getr. / GBox: AS-Tronic H18 für Ausrückgabel mit Rollen / for release fork with rollers	(70)
			 3400 700 459 HD  3482 000 246  1878 004 104  3151 000 493	430 10 MFZ430 430WGTZ KZISZ-5	Getr. / GBox: AS-Tronic H18 für Ausrückgabel mit Rollen / for release fork with rollers	(70)
			 3400 700 327  3482 114 031  1878 004 832  3151 263 031	430 10 GMFZ430N 430WGTZ KZISZ-6	Getr. / GBox: ZF 16S-151/181 H18 für Fahrzeuge mit Nebenantrieb / for vehicles with PTO für Nebenantrieb / for PTO	(73) (82)
			 3496 006 000		H18 langer Bügel / long handle	(86)











		CODE					
--	--	------	--	--	---	---	---

MAN

TGA		03.00 -				
26.430, 26.440 FVLH-KO H42 26.480 FVHL-KO H42	06.05 -	D2066LF11, D2066LF31, D2066LF01, D2066LF36, D2676LF05, D2676LF01	 3400 700 402 ⊗ 3482 000 246 ⊗ 1878 002 139 ⊙ 3151 000 034	430 10 MFZ430 430WGTZ KZISZ-5	Getr. / GBox: ZF-Ecosplit-3 H42	
	02.06 -		 3400 700 460 HD ⊗ 3482 000 246 ⊗ 1878 004 104 ⊙ 3151 000 034	430 10 MFZ430 430WGTZ KZISZ-5	Getr. / GBox: ZF-Ecosplit-3 H42	
			 3488 017 447	400 MFZ2/400X	Getr. / GBox: ZF-Ecosplit-3 H42 für Fahrzeuge mit Zweischeibenkupplung / for vehicles with double disc clutch enthält eine Kupplungsscheibe / This part number includes one clutch disc	(77) (66)
			 1878 002 643	400 10 400WGTZ	Getr. / GBox: ZF-Ecosplit-3 H42 für Fahrzeuge mit Zweischeibenkupplung / for vehicles with double disc clutch	(77)
			 3151 262 031	KZISZ-5	Getr. / GBox: ZF-Ecosplit-3 H42 für Fahrzeuge mit Zweischeibenkupplung / for vehicles with double disc clutch	(77)
			 3400 700 404 ⊗ 3482 000 246 ⊗ 1878 002 139 ⊙ 3151 000 144	430 10 MFZ430 430WGTZ KZISZ-5	Getr. / GBox: AS-Tronic H42	
			 3400 700 445 ⊗ 3482 000 246 ⊗ 1878 002 139 ⊙ 3151 000 493	430 10 MFZ430 430WGTZ KZISZ-5	Getr. / GBox: AS-Tronic H42 für Ausrückgabel mit Rollen / for release fork with rollers	(70)
			 3400 700 459 HD ⊗ 3482 000 246 ⊗ 1878 004 104 ⊙ 3151 000 493	430 10 MFZ430 430WGTZ KZISZ-5	Getr. / GBox: AS-Tronic H42 für Ausrückgabel mit Rollen / for release fork with rollers	(70)
			 3400 700 327 ⊗ 3482 114 031 ⊗ 1878 004 832 ⊙ 3151 263 031	430 10 GMFZ430N 430WGTZ KZISZ-6	Getr. / GBox: ZF 16S-151/181 H42 für Fahrzeuge mit Nebenantrieb / for vehicles with PTO für Nebenantrieb / for PTO	(73) (82)
			 3496 006 000		H42 langer Bügel / long handle	(86)



























































		CODE				
--	--	------	--	---	---	---

MAN

TGA		03.00 -				
26.460 FDC, FDLC, FDLC/M, FDLC-WW, FDRC, FDLRC-WW H29 H25 H63	01.01 -	D2876LF07, D2876LF05, D2876LF12, D2876LF25, D2876LF13, D2876LF04	 3400 700 402 ⊗ 3482 000 246 ⊗ 1878 002 139 ⊙ 3151 000 034	430 10 MFZ430 430WGTZ KZISZ-5	Getr. / GBox: ZF Ecosplit-3, Eaton	
26.460 FDK, FDLK, FDLRK H29 H25	01.01 -		 3400 700 460 HD ⊗ 3482 000 246 ⊗ 1878 004 104 ⊙ 3151 000 034	430 10 MFZ430 430WGTZ KZISZ-5	Getr. / GBox: ZF Ecosplit-3, Eaton	
26.460 FDS, FDLS, FDLS/M, FDLS-WW, FDRS-WW, FDLRS-WW H25 H29 H63	06.01 -		 3488 017 447	400 MFZ2/400X	Getr. / GBox: ZF Ecosplit-3 für Fahrzeuge mit Zweischeibenkupplung / for vehicles with double disc clutch enthält eine Kupplungsscheibe / This part number includes one clutch disc	(77) (66)
26.460 FD-TM, FDR-TM H25	01.01 -		 1878 002 643	400 10 400WGTZ	Getr. / GBox: ZF Ecosplit-3 für Fahrzeuge mit Zweischeibenkupplung / for vehicles with double disc clutch	(77)
26.460 FNLC, FNLCR, FNLLC, FNLLRW, FNLLRC H17 H20	04.00 -		 3151 262 031	KZISZ-5	Getr. / GBox: ZF Ecosplit-3 für Fahrzeuge mit Zweischeibenkupplung / for vehicles with double disc clutch	(77)
26.480 FDC, FDLC, FDRC, FDLC/M, FDLRC-WW H29 H63 H25	09.02 -		 3400 700 404 ⊗ 3482 000 246 ⊗ 1878 002 139 ⊙ 3151 000 144	430 10 MFZ430 430WGTZ KZISZ-5	Getr. / GBox: ZF-AS-Tronic	
26.480 FDK, FDLK, FDLRK H25 H29	09.02 -		 3400 700 445 ⊗ 3482 000 246 ⊗ 1878 002 139 ⊙ 3151 000 493	430 10 MFZ430 430WGTZ KZISZ-5	Getr. / GBox: ZF-AS-Tronic für Ausrückgabel mit Rollen / for release fork with rollers	(70)
26.480 FDS, FDLS, FDLS/M, FDLRS-WW, FDRS H25 H63 H29	09.02 -		 3400 700 459 HD ⊗ 3482 000 246 ⊗ 1878 004 104 ⊙ 3151 000 493	430 10 MFZ430 430WGTZ KZISZ-5	Getr. / GBox: ZF-AS-Tronic für Ausrückgabel mit Rollen / for release fork with rollers	(70)
26.480 FD-TM H63 H25	09.02 -		 3400 700 327 ⊗ 3482 114 031 ⊗ 1878 004 832 ⊙ 3151 263 031	430 10 GMFZ430N 430WGTZ KZISZ-6	Getr. / GBox: ZF 16S-151/181 für Fahrzeuge mit Nebenantrieb / for vehicles with PTO	(73)
26.510 FDC, FDC/M, FDRC, FDLC, FDLC/M, FDLRC H25 H29	01.01 -		 3496 006 000		langer Bügel / long handle	(82) (86)
26.510 FDS, FDLS, FDLS/M, FDRS, FDLRS H25 H29	01.01 -					
26.510 FNLC, FNLLC, FNLLW, FNLLRC, FVLC H17 H23 H20	12.00 -					
26.530 FDC, FDLC, FDC/M, FDLRC H29 H25	01.01 -					
26.530 FDK, FDLK, FDLRK H29 H25	09.02 -					
26.530 FDS, FDLS, FDLS/M, FDLRS H29 H25	01.01 -					
28.460 FNLC, FNLLC, FNLCR H86 H87	09.02 -					
28.460 FNLS, FNLSR H86	09.02 -					
28.480 FNLC, FNLLC, FNLCR H86 H87	09.02 -					
28.480 FNLS, FNLSR H86	09.02 -					
28.510 FNLC, FNLLC, FNLCR H86 H87	09.02 -					
28.510 FNLS, FNLSR H86	09.02 -					
28.530 FNLC, FNLLC, FNLCR H87 H86	09.02 -					
28.530 FNLS, FNLSR H86	09.02 -					
33.460 FDC, FDC-WW, FDLC, FDLRC, FDRC-WW H25 H29 H62 H28	09.02 -					
33.460 FDK, FDK-WW, FDLK, FDRK-WW H29 H28 H25 H62	09.02 -					
33.460 FDS, FDLS, FDLS/M, FDLRS, FDRS-WW H29 H25 H62 H28	09.02 -					
33.460 FD-TM, FDR-TM H25	09.02 -					

		CODE				
--	--	------	--	---	---	---













MAN

TGA		03.00 -				
33.480 FDC, FDC-WW, FDLRC, FDRK-WW, FDLRC H29 H28 H62 H25 33.480 FDK, FDK-WW, FDLK, FDRK-WW H29 H62 H25 H28 33.480 FDS, FDS-WW, FDLK, FDLR/M, FDRS-WW, FDLRS H62 H28 H25 H29 33.480 FD-TM H25 33.510 FDC, FDC/M, FDLRC, FDRK, FDLRC H29 H25 33.510 FDS, FDLK/M, FDRS, FDLRS/M H29 H25 33.530 FDC, FDC/M, FDLRC, FDRK, FDLRC H25 H29 33.530 FDK, FDLK H25 H29 33.530 FDS, FDLK, FDLK/M, FDRS, FDLRS H25 H29	09.02-	D2876LF07, D2876LF05, D2876LF12, D2876LF25, D2876LF13, D2876LF04	 3400 700 402  3482 000 246  1878 002 139  3151 000 034	430 10 MFZ430 430WGTZ KZISZ-5	Getr. / GBox: ZF Ecosplit-3, Eaton	
	09.02-		 3400 700 460 HD  3482 000 246  1878 004 104  3151 000 034	430 10 MFZ430 430WGTZ KZISZ-5	Getr. / GBox: ZF Ecosplit-3, Eaton	
	09.02-		 3488 017 447	400 MFZ2/400X	Getr. / GBox: ZF Ecosplit-3 für Fahrzeuge mit Zweischeibenkupplung / for vehicles with double disc clutch enthält eine Kupplungsscheibe / This part number includes one clutch disc	(77) (66)
	09.02-		 1878 002 643	400 10 400WGTZ	Getr. / GBox: ZF Ecosplit-3 für Fahrzeuge mit Zweischeibenkupplung / for vehicles with double disc clutch	(77)
	09.02-		 3151 262 031	KZISZ-5	Getr. / GBox: ZF Ecosplit-3 für Fahrzeuge mit Zweischeibenkupplung / for vehicles with double disc clutch	(77)
	09.02-		 3400 700 404  3482 000 246  1878 002 139  3151 000 144	430 10 MFZ430 430WGTZ KZISZ-5	Getr. / GBox: ZF-AS-Tronic	
	07.03-		 3400 700 445  3482 000 246  1878 002 139  3151 000 493	430 10 MFZ430 430WGTZ KZISZ-5	Getr. / GBox: ZF-AS-Tronic für Ausrückgabel mit Rollen / for release fork with rollers	(70)
	07.03-		 3400 700 459 HD  3482 000 246  1878 004 104  3151 000 493	430 10 MFZ430 430WGTZ KZISZ-5	Getr. / GBox: ZF-AS-Tronic für Ausrückgabel mit Rollen / for release fork with rollers	(70)
			 3400 700 327  3482 114 031  1878 004 832  3151 263 031	430 10 GMFZ430N 430WGTZ KZISZ-6	Getr. / GBox: ZF 16S-151/181 für Fahrzeuge mit Nebenantrieb / for vehicles with PTO für Nebenantrieb / for PTO	(73) (82)
			 3496 006 000		langer Bügel / long handle	(86)
32.360 FFD-TM H36 H48	01.02-	D2866LF27	 3400 700 403  3482 000 361  1878 004 832  3151 000 144	430 10 MFZ430 430WGTZ KZISZ-5	Getr. / GBox: AS-Tronic für Ausrückgabel mit Nocken / for release fork with cams	(69)
			3400 127 401  3482 000 361  1878 004 832  3151 000 034	430 10 MFZ430 430WGTZ KZISZ-5	Getr. / GBox: Ecosplit 3	
33.360 FDC, FDC-WW, FDLK/M, FDRK-WW, FDLRC H25 H28 H29 H62 33.360 FDK, FDK-WW, FDLK, FDRK-WW H29 H62 H25 H28 33.360 FDS, FDS-WW, FDLK, FDLR/M, FDRS-WW H29 H62 H25 H28 33.360 FD-TM, FDR-TM H25 33.410 FDC, FDC-WW, FDLK, FDLRC, FDRK-WW H29 H28 H62 H25 33.410 FDK, FDK-WW, FDLK, FDRK-WW H25 H28 H62 H29 33.410 FDS, FDS-WW, FDLK, FDLR/M, FDLRS, FDRS-WW H29 H62 H28 H25 33.410 FD-TM, FDR-TM H25	10.00-	D2866LF27, D2866LF28, D2866LF37, D2866LF32	 3400 127 401  3482 000 361  1878 004 832  3151 000 034	430 10 MFZ430 430WGTZ KZISZ-5	Getr. / GBox: ZF Ecosplit-3	
	01.01-		 3400 700 380 HD  3482 000 361  1878 080 037  3151 000 034	430 10 MFZ430 430WGTZ KZISZ-5	Getr. / GBox: ZF Ecosplit-3	
	10.00-		 3488 017 447	400 MFZ2/400X	Getr. / GBox: ZF Ecosplit-3 für Fahrzeuge mit Zweischeibenkupplung / for vehicles with double disc clutch enthält eine Kupplungsscheibe / This part number includes one clutch disc	(77) (66)
	10.00-		 1878 002 643	400 10 400WGTZ	Getr. / GBox: ZF Ecosplit-3 für Fahrzeuge mit Zweischeibenkupplung / for vehicles with double disc clutch	(77)
	10.00-		 3151 262 031	KZISZ-5	Getr. / GBox: ZF Ecosplit-3 für Fahrzeuge mit Zweischeibenkupplung / for vehicles with double disc clutch	(77)
	10.00-		 3400 700 403  3482 000 361  1878 004 832  3151 000 144	430 10 MFZ430 430WGTZ KZISZ-5	Getr. / GBox: ZF-AS-Tronic für Ausrückgabel mit Nocken / for release fork with cams	(69)
	10.00-		 3400 700 450  3482 000 361  1878 004 832  3151 000 493	430 10 MFZ430 430WGTZ KZISZ-5	Getr. / GBox: ZF-AS-Tronic für Ausrückgabel mit Rollen / for release fork with rollers	(70)
	10.00-		 3400 700 327  3482 114 031  1878 004 832  3151 263 031	430 10 GMFZ430N 430WGTZ KZISZ-6	Getr. / GBox: ZF 16S-151/181 für Fahrzeuge mit Nebenantrieb / for vehicles with PTO für Nebenantrieb / for PTO	(73) (82)
			 3496 006 000		langer Bügel / long handle	(86)





		CODE				
--	--	------	--	---	---	---

MAN

TGA 03.00 -







































41.530 FVDS, FVDLS H94	09.02-	D2876LF13	 3400 700 402 ⊗ 3482 000 246 ⊗ 1878 002 139 ⊙ 3151 000 034	430 10 MFZ430 430WGTZ KZISZ-5	Getr. / GBox: ZF Ecosplit-3	
			 3400 700 460 HD ⊗ 3482 000 246 ⊗ 1878 004 104 ⊙ 3151 000 034	430 10 MFZ430 430WGTZ KZISZ-5	Getr. / GBox: ZF Ecosplit-3	
			 3488 017 447	400 MFZ2/400X	Getr. / GBox: ZF Ecosplit-3 für Fahrzeuge mit Zweischeibenkupplung / for vehicles with double disc clutch enthält eine Kupplungsscheibe / This part number includes one clutch disc	(77) (66)
			 1878 002 643	400 10 400WGTZ	Getr. / GBox: ZF Ecosplit-3 für Fahrzeuge mit Zweischeibenkupplung / for vehicles with double disc clutch	(77)
			 3151 262 031	KZISZ-5	Getr. / GBox: ZF Ecosplit-3 für Fahrzeuge mit Zweischeibenkupplung / for vehicles with double disc clutch	(77)
			 3400 700 404 ⊗ 3482 000 246 ⊗ 1878 002 139 ⊙ 3151 000 144	430 10 MFZ430 430WGTZ KZISZ-5	Getr. / GBox: AS-Tronic	
			 3400 700 445 ⊗ 3482 000 246 ⊗ 1878 002 139 ⊙ 3151 000 493	430 10 MFZ430 430WGTZ KZISZ-5	Getr. / GBox: AS-Tronic für Ausrückgabel mit Rollen / for release fork with rollers	(70)
			 3400 700 459 HD ⊗ 3482 000 246 ⊗ 1878 004 104 ⊙ 3151 000 493	430 10 MFZ430 430WGTZ KZISZ-5	Getr. / GBox: AS-Tronic für Ausrückgabel mit Rollen / for release fork with rollers	(70)
 3496 006 000		langer Bügel / long handle	(86)			
41.660 FVDS, FVDLS H95	09.02-	D2840LF25	 3488 017 447	400 MFZ2/400X	Getr. / GBox: ZF Ecosplit-3 für Fahrzeuge mit Zweischeibenkupplung / for vehicles with double disc clutch enthält eine Kupplungsscheibe / This part number includes one clutch disc	(77) (66)
			 1878 002 643	400 10 400WGTZ	Getr. / GBox: ZF Ecosplit-3 für Fahrzeuge mit Zweischeibenkupplung / for vehicles with double disc clutch	(77)
			 3151 262 031	KZISZ-5	Getr. / GBox: ZF Ecosplit-3 für Fahrzeuge mit Zweischeibenkupplung / for vehicles with double disc clutch	(77)
			 3496 006 000		Getr. / GBox: ZF Ecosplit-3 für Fahrzeuge mit Zweischeibenkupplung / for vehicles with double disc clutch langer Bügel / long handle	(77) (86)



















TGL 04.05 -

7.150, 8.150 FC, FRC, FLC, FLRC N03 N11 N13 N01 8.150 FK, FRK, FK-L, FRK-L N13 N03	04.05-	D0834LFL63/66	 3400 710 011 ⊗ 3482 000 461 ⊗ 1878 079 331 ⊙ 3182 600 142	362 10 MF362 362WGTZ	Getr. / GBox: ZF 6S-850 N03,N13 Abgasnorm: Euro5/Euro6 / Exhaust Emission Norm: Euro5/Euro6 Füllmedium: Mineralöl / Fill Medium: Mineral Oil	(7) (24)	
			 3400 700 303 ⊗ 3482 000 461 ⊗ 1878 079 331	362 10 MF362 362WGTZ	Getr. / GBox: ZF 6S-850 Getr. / GBox: ZF 6AS-850 N03,N13 Abgasnorm: Euro5/Euro6 / Exhaust Emission Norm: Euro5/Euro6	(7)	
	10.06-			 3400 700 394 ⊗ 3482 000 664 ⊗ 1878 004 540 ⊙ 3151 000 512	395 10 MF395 395WGTZ KZIS-4	Getr. / GBox: ZF 6S-800 TO Getr. / GBox: ZF 6AS-800/1000 N03,N13 Abgasnorm: Euro5/Euro6 / Exhaust Emission Norm: Euro5/Euro6	(7)
				 3151 000 512	KZIS-4	Getr. / GBox: ZF 6AS-850 Getr. / GBox: ZF 6S-800 TO Getr. / GBox: ZF 6AS-800/1000 N03,N13 Abgasnorm: Euro5/Euro6 / Exhaust Emission Norm: Euro5/Euro6	(7)
				 1863 869 042		N03,N13 Abgasnorm: Euro5/Euro6 / Exhaust Emission Norm: Euro5/Euro6	(7)

		CODE				
--	--	------	--	---	---	---





































MAN

TGL		04.05 -				
7.180 FC, FLC, FRC, FLRC N13 N01 N03 N11 8.180 FC, FRC, FLC, FLRC N03 N13 8.180 FK, FK-L, FRK, FRK-L N03 N13	04.05 -	D0834LFL64/67	 3400 710 011  3482 000 461  1878 079 331  3182 600 142	362 10 MF362 362WGTZ	Getr. / GBox: ZF 6S-850 N03,N13 Abgasnorm: Euro5/Euro6 / Exhaust Emission Norm: Euro5/Euro6 Füllmedium: Mineralöl / Fill Medium: Mineral Oil	(7) (24)
	04.05 -		 3400 700 303  3482 000 461  1878 079 331	362 10 MF362 362WGTZ	Getr. / GBox: ZF 6S-850 Getr. / GBox: ZF 6AS-850 N03,N13 Abgasnorm: Euro5/Euro6 / Exhaust Emission Norm: Euro5/Euro6	(7)
	04.05 -		 3400 700 394  3482 000 664  1878 004 540  3151 000 512	395 10 MF395 395WGTZ KZIS-4	Getr. / GBox: ZF 6S-800 TO Getr. / GBox: ZF 6AS-800/1000 N03,N13 Abgasnorm: Euro5/Euro6 / Exhaust Emission Norm: Euro5/Euro6	(7)
			 3151 000 512	KZIS-4	Getr. / GBox: ZF 6AS-850 Getr. / GBox: ZF 6S-800 TO Getr. / GBox: ZF 6AS-800/1000 N03,N13 Abgasnorm: Euro5/Euro6 / Exhaust Emission Norm: Euro5/Euro6	(7)
			 1863 869 042		N03,N13 Abgasnorm: Euro5/Euro6 / Exhaust Emission Norm: Euro5/Euro6	(7)
7.220 FC, FLC, FRC, FLRC 7.250 FC, FLC, FRC, FLRC	04.05 -	D0834LFL63/65	 3400 710 011  3482 000 461  1878 079 331  3182 600 142	362 10 MF362 362WGTZ	Getr. / GBox: ZF 6S-850 N03,N13 Abgasnorm: Euro5/Euro6 / Exhaust Emission Norm: Euro5/Euro6 Füllmedium: Mineralöl / Fill Medium: Mineral Oil	(7) (24)
	04.05 -		 3400 700 303  3482 000 461  1878 079 331	362 10 MF362 362WGTZ	Getr. / GBox: ZF 6S-850 Getr. / GBox: ZF 6AS-850 N03,N13 Abgasnorm: Euro5/Euro6 / Exhaust Emission Norm: Euro5/Euro6	(7)
			 3400 700 394  3482 000 664  1878 004 540  3151 000 512	395 10 MF395 395WGTZ KZIS-4	Getr. / GBox: ZF 6S-800 TO Getr. / GBox: ZF 6AS-800/1000 N03,N13 Abgasnorm: Euro5/Euro6 / Exhaust Emission Norm: Euro5/Euro6	(7)
			 3151 000 512	KZIS-4	Getr. / GBox: ZF 6AS-850 Getr. / GBox: ZF 6S-800 TO Getr. / GBox: ZF 6AS-800/1000 N03,N13 Abgasnorm: Euro5/Euro6 / Exhaust Emission Norm: Euro5/Euro6	(7)
			 1863 869 042		N03,N13 Abgasnorm: Euro5/Euro6 / Exhaust Emission Norm: Euro5/Euro6	(7)
8.210 FC, FRC, FLC, FLRC N13 N03 8.210 FK, FK-L, FRK, FRK-L N03 N13	04.05 -	D0834LFL55	 3400 710 011  3482 000 461  1878 079 331  3182 600 142	362 10 MF362 362WGTZ	Getr. / GBox: ZF 6S-850 N03,N13 Abgasnorm: Euro 4 (D4) / Exhaust Emission Norm: Euro 4 (D4) Füllmedium: Mineralöl / Fill Medium: Mineral Oil	(2) (24)
	04.05 -		 3400 700 303  3482 000 461  1878 079 331	362 10 MF362 362WGTZ	Getr. / GBox: ZF 6S-850 Getr. / GBox: ZF 6AS-850 N03,N13 Abgasnorm: Euro 4 (D4) / Exhaust Emission Norm: Euro 4 (D4)	(2)
			 3400 700 394  3482 000 664  1878 004 540  3151 000 512	395 10 MF395 395WGTZ KZIS-4	Getr. / GBox: ZF 6S-800 TO Getr. / GBox: ZF 6AS-800/1000 N03,N13 Abgasnorm: Euro 4 (D4) / Exhaust Emission Norm: Euro 4 (D4)	(2)
			 3151 000 512	KZIS-4	Getr. / GBox: ZF 6AS-850 Getr. / GBox: ZF 6S-800 TO Getr. / GBox: ZF 6AS-800/1000 N03,N13 Abgasnorm: Euro 4 (D4) / Exhaust Emission Norm: Euro 4 (D4)	(2)
			 1863 869 042		N03,N13 Abgasnorm: Euro 4 (D4) / Exhaust Emission Norm: Euro 4 (D4)	(2)

TGL		04.05 -				
8.220 FC, FLC, FRC, FLRC N03 N13 8.220 FK, FRK, FK-L, FRK-L N03 N13	04.05 -	D0834LFL65/68	 3400 710 011 3482 000 461 1878 079 331 3182 600 142	362 10 MF362 362WGTZ	Getr. / GBox: ZF 6S-850 N03,N13 Abgasnorm: Euro5/Euro6 / Exhaust Emission Norm: Euro5/Euro6 Füllmedium: Mineralöl / Fill Medium: Mineral Oil	(7) (24)
	04.05 -		 3400 700 303 3482 000 461 1878 079 331	362 10 MF362 362WGTZ	Getr. / GBox: ZF 6S-850 Getr. / GBox: ZF 6AS-850 N03,N13 Abgasnorm: Euro5/Euro6 / Exhaust Emission Norm: Euro5/Euro6	(7)
			 3400 700 394 3482 000 664 1878 004 540 3151 000 512	395 10 MF395 395WGTZ KZIS-4	Getr. / GBox: ZF 6S-800 TO Getr. / GBox: ZF 6AS-800/1000 N03,N13 Abgasnorm: Euro5/Euro6 / Exhaust Emission Norm: Euro5/Euro6	(7)
			 3151 000 512	KZIS-4	Getr. / GBox: ZF 6AS-850 Getr. / GBox: ZF 6S-800 TO Getr. / GBox: ZF 6AS-800/1000 N03,N13 Abgasnorm: Euro5/Euro6 / Exhaust Emission Norm: Euro5/Euro6	(7)
			 1863 869 042		N03,N13 Abgasnorm: Euro5/Euro6 / Exhaust Emission Norm: Euro5/Euro6	(7)
8.240 FC, FRC, FLC, FLRC N02 N12 8.240 FK, FK-L, FRK, FRK-L N12 N02	04.05 -	D0836LFL50, D0836LFL40, D0836LFL53	 3400 121 701 3482 000 467 1862 506 131 3151 253 031	395 10 MFZ395 395WGTZ KZIS-4,5	Getr. / GBox: EATON FS/FSO-8309	
	04.05 -		 3496 006 000		Getr. / GBox: EATON FS/FSO-8309 langer Bügel / long handle	(86)
			 3482 000 546	395 MFZ395	Getr. / GBox: 12 AS 1210 TO Getr. / GBox: AS-Tronic	
			 1862 506 131	395 10 395WGTZ	Getr. / GBox: 12 AS 1210 TO Getr. / GBox: AS-Tronic	
			 3151 000 144	KZISZ-5	Getr. / GBox: 12 AS 1210 TO Getr. / GBox: AS-Tronic für Ausrückgabel mit Nocken / for release fork with cams	(69)
			 3400 700 364 3482 000 546 1862 506 131 3151 000 493	395 10 MFZ395 395WGTZ KZISZ-5	Getr. / GBox: 12 AS 1210 TO Getr. / GBox: AS-Tronic für Ausrückgabel mit Rollen / for release fork with rollers	(70)
			 3400 700 396 3482 000 679 1862 506 131 3151 000 512	395 10 MF395 395WGTZ KZIS-4	Getr. / GBox: ZF-9S-1310TO	
8.250 FC, FLC, FLRC, FRC N02 N12 8.250 FK, FK-L, FRK, FRK-L N02 N12	04.05 -	D0836LFL63/66	 3400 700 364 3482 000 546 1862 506 131 3151 000 493	395 10 MFZ395 395WGTZ KZISZ-5	Getr. / GBox: ZF 12AS-1210 TO N02,N12 Abgasnorm: Euro5/Euro6 / Exhaust Emission Norm: Euro5/Euro6	(7) (70)
	04.05 -		 3482 000 546	395 MFZ395	Getr. / GBox: ZF 12AS-1010/1210 Getr. / GBox: ZF 12AS-1210 TO N02,N12 Abgasnorm: Euro5/Euro6 / Exhaust Emission Norm: Euro5/Euro6	(7)
			 1862 506 131	395 10 395WGTZ	Getr. / GBox: ZF 12AS-1010/1210 Getr. / GBox: ZF 12AS-1210 TO Getr. / GBox: ZF 9S-1310 TO, HD N02,N12 Abgasnorm: Euro5/Euro6 / Exhaust Emission Norm: Euro5/Euro6	(7)
			 3151 000 144	KZISZ-5	Getr. / GBox: ZF 12AS-1210 TO N02,N12 Abgasnorm: Euro5/Euro6 / Exhaust Emission Norm: Euro5/Euro6 für Ausrückgabel mit Nocken / for release fork with cams	(7) (69)
			 3400 700 396 3482 000 679 1862 506 131 3151 000 512	395 10 MF395 395WGTZ KZIS-4	Getr. / GBox: ZF 9S-1310 TO, HD N02,N12 Abgasnorm: Euro5/Euro6 / Exhaust Emission Norm: Euro5/Euro6	(7)
			 1878 006 713 HD	395 10 395WGTZ	N02,N12 Abgasnorm: Euro5/Euro6 / Exhaust Emission Norm: Euro5/Euro6	(7)
			 1863 869 042		N02,N12 Abgasnorm: Euro5/Euro6 / Exhaust Emission Norm: Euro5/Euro6	(7)



























		CODE				
--	--	------	--	---	---	---

MAN

TGL		04.05 -				
10.180 FC, FRC, FLC, FLRC N05 N15 10.180 FK, FRK N05 12.180 FC, FRC, FLC, FLRC N61 N05 N15 12.180 FK, FRK N15 N05	04.05-	D0834LFL64/67	 3400 710 011  3482 000 461  1878 079 331  3182 600 142	362 10 MF362 362WGTZ	Getr. / GBox: ZF 6S-850 N05,N15 Abgasnorm: Euro5/Euro6 / Exhaust Emission Norm: Euro5/Euro6 Füllmedium: Mineralöl / Fill Medium: Mineral Oil	(7) (24)
	04.05-		 3400 700 303 	362 10 MF362 362WGTZ	Getr. / GBox: ZF 6S-850 Getr. / GBox: ZF 6AS-850 N05,N15 Abgasnorm: Euro5/Euro6 / Exhaust Emission Norm: Euro5/Euro6	(7)
	04.05-		 3400 700 394  3482 000 664  1878 004 540  3151 000 512	395 10 MF395 395WGTZ KZIS-4	Getr. / GBox: ZF 6S-800 TO Getr. / GBox: ZF 6AS-800/1000 N05,N15 Abgasnorm: Euro5/Euro6 / Exhaust Emission Norm: Euro5/Euro6	(7)
	04.05-		 3151 000 512	KZIS-4	Getr. / GBox: ZF 6AS-850 Getr. / GBox: ZF 6S-800 TO Getr. / GBox: ZF 6AS-800/1000 N05,N15 Abgasnorm: Euro5/Euro6 / Exhaust Emission Norm: Euro5/Euro6	(7)
			 1863 869 042		N05,N15 Abgasnorm: Euro5/Euro6 / Exhaust Emission Norm: Euro5/Euro6	(7)
10.210 FC, FRC, FLC, FLRC N15 N05	04.05-	D0834LFL55	 3400 710 011  3482 000 461  1878 079 331  3182 600 142	362 10 MF362 362WGTZ	Getr. / GBox: ZF 6S-850 N05,N15 Abgasnorm: Euro 5 / Exhaust Emission Norm: Euro 5 Füllmedium: Mineralöl / Fill Medium: Mineral Oil	(3) (24)
			 3400 700 303 	362 10 MF362 362WGTZ	Getr. / GBox: ZF 6S-850 Getr. / GBox: ZF 6AS-850 N05,N15 Abgasnorm: Euro 5 / Exhaust Emission Norm: Euro 5	(3)
			 3400 700 394  3482 000 664  1878 004 540  3151 000 512	395 10 MF395 395WGTZ KZIS-4	Getr. / GBox: ZF 6S-800 TO Getr. / GBox: ZF 6AS-800/1000 N05,N15 Abgasnorm: Euro 5 / Exhaust Emission Norm: Euro 5	(3)
			 3151 000 512	KZIS-4	Getr. / GBox: ZF 6AS-850 Getr. / GBox: ZF 6S-800 TO Getr. / GBox: ZF 6AS-800/1000 N05,N15 Abgasnorm: Euro 5 / Exhaust Emission Norm: Euro 5	(3)
			 1863 869 042		N05,N15 Abgasnorm: Euro 5 / Exhaust Emission Norm: Euro 5	(3)
10.210 FK, FRK N05	04.05-	D0834LFL55/65	 3400 710 011  3482 000 461  1878 079 331  3182 600 142	362 10 MF362 362WGTZ	Getr. / GBox: ZF 6S-850 N05,N15 Abgasnorm: Euro 5 / Exhaust Emission Norm: Euro 5 Füllmedium: Mineralöl / Fill Medium: Mineral Oil	(3) (24)
			 3400 700 303 	362 10 MF362 362WGTZ	Getr. / GBox: ZF 6S-850 Getr. / GBox: ZF 6AS-850 N05,N15 Abgasnorm: Euro 5 / Exhaust Emission Norm: Euro 5	(3)
			 3400 700 394  3482 000 664  1878 004 540  3151 000 512	395 10 MF395 395WGTZ KZIS-4	Getr. / GBox: ZF 6S-800 TO Getr. / GBox: ZF 6AS-800/1000 N05,N15 Abgasnorm: Euro 5 / Exhaust Emission Norm: Euro 5	(3)
			 3151 000 512	KZIS-4	Getr. / GBox: ZF 6AS-850 Getr. / GBox: ZF 6S-800 TO Getr. / GBox: ZF 6AS-800/1000 N05,N15 Abgasnorm: Euro 5 / Exhaust Emission Norm: Euro 5	(3)
			 1863 869 042		N05,N15 Abgasnorm: Euro 5 / Exhaust Emission Norm: Euro 5	(3)

		CODE				
--	--	------	--	---	---	---



































MAN







TGL		04.05 -				
10.220 FC, FLC, FRC, FLRC N15 N05 10.220 FK, FRK N05 12.220 FC, FRC, FLC, FLRC N05 N15 12.220 FK, FRK N05 N15	04.05-	D0834LFL65/68	 3400 710 011  3482 000 461  1878 079 331  3182 600 142	362 10 MF362 362WGTZ	Getr. / GBox: ZF 6S-850 N05,N15 Abgasnorm: Euro5/Euro6 / Exhaust Emission Norm: Euro5/Euro6 Füllmedium: Mineralöl / Fill Medium: Mineral Oil	(7) (24)
	04.05-		 3400 700 303  3482 000 461  1878 079 331	362 10 MF362 362WGTZ	Getr. / GBox: ZF 6S-850 Getr. / GBox: ZF 6AS-850 N05,N15 Abgasnorm: Euro5/Euro6 / Exhaust Emission Norm: Euro5/Euro6	(7)
	04.05-		 3400 700 394  3482 000 664  1878 004 540  3151 000 512	395 10 MF395 395WGTZ KZIS-4	Getr. / GBox: ZF 6S-800 TO Getr. / GBox: ZF 6AS-800/1000 N05,N15 Abgasnorm: Euro5/Euro6 / Exhaust Emission Norm: Euro5/Euro6	(7)
	04.05-		 3151 000 512	KZIS-4	Getr. / GBox: ZF 6AS-850 Getr. / GBox: ZF 6S-800 TO Getr. / GBox: ZF 6AS-800/1000 N05,N15 Abgasnorm: Euro5/Euro6 / Exhaust Emission Norm: Euro5/Euro6	(7)
			 1863 869 042		N05,N15 Abgasnorm: Euro5/Euro6 / Exhaust Emission Norm: Euro5/Euro6	(7)
10.240 FC, FRC, FLC, FLRC N04 N14 10.240 FK, FRK N04 12.240 FC, FRC, FLC, FLRC N14 N04 12.240 FK, FRK N04 N14	04.05-	D0836LFL53	 3400 700 364  3482 000 546  1862 506 131  3151 000 493	395 10 MFZ395 395WGTZ KZISZ-5	Getr. / GBox: ZF 12AS-1210 TO N04,N14 Abgasnorm: Euro 4 (D4) / Exhaust Emission Norm: Euro 4 (D4) für Ausrückgabel mit Rollen / for release fork with rollers	(2) (70)
	04.05-		 3482 000 546	395 MFZ395	Getr. / GBox: ZF 12AS-1010/1210 Getr. / GBox: ZF 12AS-1210 TO N04,N14 Abgasnorm: Euro 4 (D4) / Exhaust Emission Norm: Euro 4 (D4)	(2)
	04.05-		 1862 506 131	395 10 395WGTZ	Getr. / GBox: ZF 12AS-1010/1210 Getr. / GBox: ZF 12AS-1210 TO Getr. / GBox: ZF 9S-1310 TO, HD N04,N14 Abgasnorm: Euro 4 (D4) / Exhaust Emission Norm: Euro 4 (D4)	(2)
	04.05-		 3151 000 144	KZISZ-5	Getr. / GBox: ZF 12AS-1210 TO N04,N14 Abgasnorm: Euro 4 (D4) / Exhaust Emission Norm: Euro 4 (D4) für Ausrückgabel mit Nocken / for release fork with cams	(2) (69)
			 3400 700 396  3482 000 679  1862 506 131  3151 000 512	395 10 MFZ395 395WGTZ KZIS-4	Getr. / GBox: ZF 9S-1310 TO, HD N04,N14 Abgasnorm: Euro 4 (D4) / Exhaust Emission Norm: Euro 4 (D4)	(2)
			 1878 006 713 HD	395 10 395WGTZ	N04,N14 Abgasnorm: Euro 4 (D4) / Exhaust Emission Norm: Euro 4 (D4)	(2)
			 1863 869 042		N04,N14 Abgasnorm: Euro 4 (D4) / Exhaust Emission Norm: Euro 4 (D4)	(2)

		CODE				
--	--	------	--	---	---	---

MAN













TGL 04.05 -

10.250 FC, FLC, FRC, FLRC N04 N14 10.250 FK, FRK N04 12.250 FC, FLC, FRC, FLRC N04 N14 12.250 FK, FRK N14 N04	04.05-	D0836LFL63/66	 3400 700 364  3482 000 546  1862 506 131  3151 000 493	395 10 MFZ395 395WGTZ KZISZ-5	Getr. / GBox: ZF 12AS-1210 TO N04,N14 Abgasnorm: Euro5/Euro6 / Exhaust Emission Norm: Euro5/Euro6 für Ausrückgabel mit Rollen / for release fork with rollers	(7) (70)
	04.05-		 3482 000 546	395 MFZ395	Getr. / GBox: ZF 12AS-1010/1210 Getr. / GBox: ZF 12AS-1210 TO N04,N14 Abgasnorm: Euro5/Euro6 / Exhaust Emission Norm: Euro5/Euro6	(7)
	04.05-		 1862 506 131	395 10 395WGTZ	Getr. / GBox: ZF 12AS-1010/1210 Getr. / GBox: ZF 12AS-1210 TO Getr. / GBox: ZF 9S-1310 TO, HD N04,N14 Abgasnorm: Euro5/Euro6 / Exhaust Emission Norm: Euro5/Euro6	(7)
	04.05-		 3151 000 144	KZISZ-5	Getr. / GBox: ZF 12AS-1210 TO N04,N14 Abgasnorm: Euro5/Euro6 / Exhaust Emission Norm: Euro5/Euro6 für Ausrückgabel mit Nocken / for release fork with cams	(7) (69)
			 3400 700 396  3482 000 679  1862 506 131  3151 000 512	395 10 MF395 395WGTZ KZIS-4	Getr. / GBox: ZF 9S-1310 TO, HD N04,N14 Abgasnorm: Euro5/Euro6 / Exhaust Emission Norm: Euro5/Euro6	(7)
			 1878 006 713 HD	395 10 395WGTZ	N04,N14 Abgasnorm: Euro5/Euro6 / Exhaust Emission Norm: Euro5/Euro6	(7)
			 1863 869 042		N04,N14 Abgasnorm: Euro5/Euro6 / Exhaust Emission Norm: Euro5/Euro6	(7)
12.210 FC, FRC, FLC, FLRC N61 N05 N15	04.05-	D0834LFL64	 3400 710 011  3482 000 461  1878 079 331  3182 600 142	362 10 MF362 362WGTZ	Getr. / GBox: ZF 6S-850 N05,N15 Abgasnorm: Euro 5 / Exhaust Emission Norm: Euro 5 Füllmedium: Mineralöl / Fill Medium: Mineral Oil	(3) (24)
			 3400 700 303	362 10 MF362 362WGTZ	Getr. / GBox: ZF 6S-850 Getr. / GBox: ZF 6AS-850 N05,N15 Abgasnorm: Euro 5 / Exhaust Emission Norm: Euro 5	(3)
			 3400 700 394  3482 000 664  1878 004 540  3151 000 512	395 10 MF395 395WGTZ KZIS-4	Getr. / GBox: ZF 6S-800 TO Getr. / GBox: ZF 6AS-800/1000 N05,N15 Abgasnorm: Euro 5 / Exhaust Emission Norm: Euro 5	(3)
			 3151 000 512	KZIS-4	Getr. / GBox: ZF 6AS-850 Getr. / GBox: ZF 6S-800 TO Getr. / GBox: ZF 6AS-800/1000 N05,N15 Abgasnorm: Euro 5 / Exhaust Emission Norm: Euro 5	(3)
			 1863 869 042		N05,N15 Abgasnorm: Euro 5 / Exhaust Emission Norm: Euro 5	(3)
12.210 FK, FRK N15 N05	04.05-	D0834LFL55	 3400 710 011  3482 000 461  1878 079 331  3182 600 142	362 10 MF362 362WGTZ	Getr. / GBox: ZF 6S-850 N05,N15 Abgasnorm: Euro 4 (D4) / Exhaust Emission Norm: Euro 4 (D4) Füllmedium: Mineralöl / Fill Medium: Mineral Oil	(2) (24)
			 3400 700 303	362 10 MF362 362WGTZ	Getr. / GBox: ZF 6S-850 Getr. / GBox: ZF 6AS-850 N05,N15 Abgasnorm: Euro 4 (D4) / Exhaust Emission Norm: Euro 4 (D4)	(2)
			 3400 700 394  3482 000 664  1878 004 540  3151 000 512	395 10 MF395 395WGTZ KZIS-4	Getr. / GBox: ZF 6S-800 TO Getr. / GBox: ZF 6AS-800/1000 N05,N15 Abgasnorm: Euro 4 (D4) / Exhaust Emission Norm: Euro 4 (D4)	(2)
			 3151 000 512	KZIS-4	Getr. / GBox: ZF 6AS-850 Getr. / GBox: ZF 6S-800 TO Getr. / GBox: ZF 6AS-800/1000 N05,N15 Abgasnorm: Euro 4 (D4) / Exhaust Emission Norm: Euro 4 (D4)	(2)
			 1863 869 042		N05,N15 Abgasnorm: Euro 4 (D4) / Exhaust Emission Norm: Euro 4 (D4)	(2)

TGM		10.05 -				
12.240 FLC, FLLC N16 N26	10.05-	D0836LFL50, D0836LFL51, D0836LFL40, D0836LFL44,	 3400 121 701 ⊗ 3482 000 467 ⊗ 1862 506 131 ⊙ 3151 253 031	395 10 MFZ395 395WGTZ KZIZ-4,5	Getr. / GBox: Eaton FS/FSO-8309	
12.280 FC, FLC, FLLC N16 N26	10.05-	D0836LFL54, D0836LFL41, D0836LFL64, D0836LFL53, D0836LFL55, D0836LFL52	 3400 700 364 ⊗ 3482 000 546 ⊗ 1862 506 131 ⊙ 3151 000 493	395 10 MFZ395 395WGTZ KZISZ-5	Getr. / GBox: AS-Tronic 12AS-1010 für Ausrückgabel mit Rollen / for release fork with rollers	(70)
13.240 FALK, FALRK, FALK-L, FALRK-L N36	04.06-		 3482 000 546	395 MFZ395	Getr. / GBox: AS-Tronic 12AS-1010	
15.240 FLK, FLRK N18	10.05-		 1862 506 131	395 10 395WGTZ	Getr. / GBox: AS-Tronic 12AS-1010	
15.280 FC, FLC, FLLC, FLRC, FLLRC N26 N18 N08 N16	10.05-		 3151 000 144	KZISZ-5	Getr. / GBox: AS-Tronic 12AS-1010 für Ausrückgabel mit Nocken / for release fork with cams	(69)
15.290 FC, FLC, FLRC, FLLC, FLLRC N16 N18 N08 N26	10.05-		 3400 700 396 ⊗ 3482 000 679 ⊗ 1862 506 131 ⊙ 3151 000 512	395 10 MF395 395WGTZ KZIS-4	Getr. / GBox: ZF-9S-1310TO	
15.330 FC, FLC, FRC, FLRC N08 N18	10.05-		 1863 869 042			
22.240 FNLLC N26	10.05-					
22.280 FNL, 22.280 FNLLC N26	10.05-					
26.280 FDK-HK, FDRK-HK N48	04.06-					
26.280 FD-TM, FDR-TM N48	04.06-					
26.330 FD, FDR N48	10.05-					
26.330 FDK-HK, FDRK-HK N48	04.06-					
26.330 FD-TM, FDR-TM N48	04.06-					







		CODE				
--	--	------	--	---	---	---

MAN

TGM		10.05 -					
12.250 FLC, FLLC N16 N26	10.05-	D0836LFL54, D0836LFL65, D0836LFL64, D0836LFL63, D0836LFL55	 3400 121 701  3482 000 467  1862 506 131  3151 253 031	395 10 MFZ395 395WGTZ KZIZ-4,5	Getr. / GBox: Eaton FS/FSO-8309		
12.290 FLC, FLLC N16 N26	10.05-		 3400 700 364  3482 000 546  1862 506 131  3151 000 493	395 10 MFZ395 395WGTZ KZISZ-5	Getr. / GBox: AS-Tronic 12AS-1010 für Ausrückgabel mit Rollen / for release fork with rollers	(70)	
13.250 FAEC, FAERC, FALC, FAL, FALRC, FALR N36 N34 N37	10.05-		 3482 000 546	395 MFZ395	Getr. / GBox: AS-Tronic 12AS-1010		
13.250 FALK, FALRK, FALK-L, FALRK-L N36	10.05-		 1862 506 131	395 10 395WGTZ	Getr. / GBox: AS-Tronic 12AS-1010		
13.290 FAEC, FAERC, FAL, FALR, FALC, FALRC N36 N34 N37	10.05-		 3151 000 144	KZISZ-5	Getr. / GBox: AS-Tronic 12AS-1010 für Ausrückgabel mit Nocken / for release fork with cams	(69)	
13.290 FALK, FALRK, FALK-L, FALRK-L N36	10.05-		 1863 869 042				
15.250 FC, FLC, FLRC, FLLC, FLLRC N08 N18 N16 N26	10.05-						
15.250 FLK, FLRK N18	10.05-						
15.290 FLK, FLRK N18	10.05-						
15.340 FC, FLC, FLRC N08 N18	10.05-						
15.340 FLK, FLRK N18	10.05-						
18.250 C/L/LX N28							
18.250 FAC, FARC N38	10.05-						
18.250 FAK, FARK, FAK-L, FARK-L N38	10.05-						
18.250 FC, FLC, FLLC, FRC, FLRC, FLLRC N08 N28 N18	10.05-						
18.250 FK, FLK, FRK, FLRK N08 N18	10.05-						
18.290 C/L/LX N28							
18.290 FAC, FARC N38	10.05-						
18.290 FAK, FARK, FAK-L, FARK-L N38	10.05-						
18.290 FC, FLC, FRC, FLRC, FLLC, FLLRC N08 N28 N18	10.05-						
18.290 FK, FLK, FRK, FLRK N08 N18	10.05-						
18.340 C/L/LX N28							
18.340 FAC, FARC N38	10.05-						
18.340 FAK, FARK, FAK-L, FARK-L N38	10.05-						
18.340 FC, FLC, FLRC, FLLC, FLLRC, FRC N18 N08 N28	10.05-						
18.340 FK, FRK, FLK, FLRK N08 N18	10.05-						
22.250 FNLLC N26	10.05-						
22.290 FNL, 22.290 FNLLC N26	10.05-						













		CODE		 Parameter		
--	--	------	--	---	---	---



MAN

TGM		10.05 -					
26.280 FD N48	10.05-	D0836LFL54, D0836LFL65, D0836LFL64, D0836LFL63, D0836LFL55	 3400 121 701 ⊗ 3482 000 467 ⊗ 1862 506 131 ⊙ 3151 253 031	395 10 MFZ395 395WGTZ KZIZ-4,5	Getr. / GBox: Eaton FS/FSO-8309		
26.280 FNLC, FNLLC, FNLRC, FNLLRC N46 N44	10.05-		 3400 700 364 ⊗ 3482 000 546 ⊗ 1862 506 131 ⊙ 3151 000 493	395 10 MFZ395 395WGTZ KZISZ-5	Getr. / GBox: AS-Tronic 12AS-1010 für Ausrückgabel mit Rollen / for release fork with rollers	(70)	
26.290 FD, FDR N48	10.05-		 3482 000 546	395 MFZ395	Getr. / GBox: AS-Tronic 12AS-1010		
26.290 FD-TM, FDR-TM N48	07.08-		 1862 506 131	395 10 395WGTZ	Getr. / GBox: AS-Tronic 12AS-1010		
26.290 FDK-HK, FDRK-HK N48	10.05-		 3151 000 144	KZISZ-5	Getr. / GBox: AS-Tronic 12AS-1010 für Ausrückgabel mit Nocken / for release fork with cams	(69)	
26.290 FNLC, FNLLC, FNLRC, FNLLRC, FVL N44 N46	10.05-		 1863 869 042				
26.330 FNLC, FNLLC, FNLRC, FNLLRC, FVL N44 N46	10.05-						
26.340 FD, FDR N48	10.05-						
26.340 FDK-HK, FDRK-HK N48	10.05-						
26.340 FNLC, FNLLC, FNLRC, FNLLRC N44 N46	10.05-						
26.340 FD-TM, FDR-TM N48	07.08-						

		CODE				
--	--	------	--	---	---	---









MAN

TGM		10.05 -					
13.240 FAL, FALC, FALRC, FAEC, FAERC, FALR N37 N34 N36	04.06-	D0836LFL50, D0836LFL51, D0836LFL40, D0836LFL44, D0836LFL41, D0836LFL54, D0836LFL53, D0836LFL55, D0836LFL52	 3400 121 701 ⊗ 3482 000 467 ⊗ 1862 506 131 ⊙ 3151 253 031	395 10 MFZ395 395WGTZ KZIZ-4,5	Getr. / GBox: Eaton FS/FSO-8309		
13.280 FAEC, FAERC, FAL, FALC, FALRC N37 N34 N36	04.06-		 3400 700 364 ⊗ 3482 000 546 ⊗ 1862 506 131 ⊙ 3151 000 493	395 10 MFZ395 395WGTZ KZISZ-5	Getr. / GBox: AS-Tronic 12AS-1010 für Ausrückgabel mit Rollen / for release fork with rollers	(70)	
13.280 FALK, FALRK, FALK-L, FALRK-L N36	04.06-		 3482 000 546	395 MFZ395	Getr. / GBox: AS-Tronic 12AS-1010		
15.240 FC, FLC, FLLC, FLRC, FLLRC N18 N63 N26 N64 N08 N16	10.05-		 1862 506 131	395 10 395WGTZ	Getr. / GBox: AS-Tronic 12AS-1010		
15.280 FLK, FLRK N18	10.05-		 3151 000 144	KZISZ-5	Getr. / GBox: AS-Tronic 12AS-1010 für Ausrückgabel mit Nocken / for release fork with cams	(69)	
15.330 FLK, FLRK N18	10.05-		 3400 700 396 ⊗ 3482 000 679 ⊗ 1862 506 131 ⊙ 3151 000 512	395 10 MFZ395 395WGTZ KZIS-4	Getr. / GBox: ZF-9S-1310TO		
18.240 FAC, FARC N64 N38	10.05-		 3400 710 001 ⊗ 3482 120 031 ⊗ 1878 044 631 ⊙ 3182 005 231	362 10 MFZ362 362GTZ HHISZ-3			
18.240 FAK, FARK, FAK-L, FARK-L N38	05.06-		 3482 083 032	430 MFZ430	Getr. / GBox: ZF S6-85/1600/1200		
18.240 FC, FRC, FLC, FLRC, FLLC, FLLRC N08 N18 N28 N62	10.05-		 1878 080 031	430 10 430WGTZ	Getr. / GBox: ZF S6-85/1600/1200		
18.240 FK, FRK, FLK, FK-L, FLRK N08 N18 N62	10.05-		 3151 000 034	KZISZ-5	Getr. / GBox: ZF S6-85/1600/1200		
18.280 FAC, FARC N38	10.05-		 3496 006 000		Getr. / GBox: ZF S6-85/1600/1200 langer Bügel / long handle	(86)	
18.280 FAK, FARK, FAK-L, FARK-L N38	10.05-		 1863 869 042				
18.280 FC, FRC, FLC, FLRC, FLLC, FLLRC N18 N62 N65 N28 N08	10.05-						
18.280 FK, FLK, FRK, FLRK, FK-L N08 N18 N62	10.05-						
18.330 FAC, FARC N38	10.05-						
18.330 FAK, FARK, FAK-L, FARK, L N38	10.05-						
18.330 FC, FRC, FLC, FLRC, FLLC, FLLRC N08 N18 N28	10.05-						
18.330 FK, FLK, FRK, FLRK, FK-L N08 N18	10.05-						

TGS		08.07 -					
TGS Euro 6	01.14-	D3876LF	 3400 700 613 ⊗ 3482 001 145 ⊗ 1878 007 126 ⊙ 3151 000 493	430 10 MZ430 430WGTPZ KZISZ-5	Getr. / GBox: AS Tronic Abgasnorm: Euro 6 / Exhaust Emission Norm: Euro 6	(4)	
			 3400 700 614 ⊗ 3482 001 180 ⊗ 1878 007 126	430 10 M430 430WGTPZ	Getr. / GBox: Traxon Abgasnorm: Euro 6 / Exhaust Emission Norm: Euro 6	(4)	
			 6482 000 216	PHIS-6/38	Getr. / GBox: Traxon Abgasnorm: Euro 6 / Exhaust Emission Norm: Euro 6 Immer erneuern / Renew everytime	(4)	(28)





















		CODE		 Parameter		
--	--	------	--	---	---	---

MAN

TGS		08.07 -				
18.320 FAC, FHLC 52S 22S	10.07-	D2066LF43, D2066LF28, D2066LF27, D2066LF42, D2066LF37, D2066LF39, D2066LF41, D2066LF26, D2066LF38	 3400 700 380 ⊗ 3482 000 361 ⊗ 1878 080 037 ⊙ 3151 000 034	430 10 MFZ430 430WGTZ KZISZ-5	Getr. / GBox: ZF Ecosplit-3 18S,22S,24S,52S,80S Abgasnorm: Euro5/Euro6 / Exhaust Emission Norm: Euro5/Euro6	(7)
18.320 FAK, FAK-L, FALK, FALK-L, FHLK, FHLK/M 80S 22S 52S	10.07-		 3400 700 381 ⊗ 3482 000 361 ⊗ 1878 080 037 ⊙ 3151 000 493	430 10 MFZ430 430WGTZ KZISZ-5	Getr. / GBox: ZF AS-Tronic 18S,22S,24S,52S,80S Abgasnorm: Euro5/Euro6 / Exhaust Emission Norm: Euro5/Euro6	(7)
18.320 FAS, FHLS, FHLS/M 52S 22S	10.07-				für Ausrückgabel mit Rollen / for release fork with rollers	(70)
18.360 FAC, FHLC 52S 22S	10.07-		 3400 700 403 ⊗ 3482 000 361 ⊗ 1878 004 832 ⊙ 3151 000 144	430 10 MFZ430 430WGTZ KZISZ-5	Getr. / GBox: ZF AS-Tronic 18S,22S,24S,52S,80S Abgasnorm: Euro5/Euro6 / Exhaust Emission Norm: Euro5/Euro6	(7)
18.360 FAK, FAK-L, FALK, FALK-L, FHLK, FHLK/M 80S 52S 22S	10.07-				für Ausrückgabel mit Nocken / for release fork with cams	(69)
18.360 FAS, FALS, FHLS, FHLS/M 52S 22S 80S	10.07-		 3400 700 327 ⊗ 3482 114 031 ⊗ 1878 004 832 ⊙ 3151 263 031	430 10 GMFZ430N 430WGTZ KZIZ-6	Getr. / GBox: ZF Ecosplit-3 18S,22S,24S,52S,80S Abgasnorm: Euro5/Euro6 / Exhaust Emission Norm: Euro5/Euro6	(7)
18.400 FAC, FHLC 22S 52S	10.07-				für Fahrzeuge mit Nebenantrieb / for vehicles with PTO	(73)
18.400 FAK, FAK-L, FALK, FALK-L, FHLK, FHLK/M 80S 52S 22S	10.07-				für Nebenantrieb / for PTO	(82)
18.400 FAS, FALS, FHLS, FHLS/M 52S 80S 22S	10.07-		 3488 017 447	400 MFZ2/400X	Getr. / GBox: ZF Ecosplit-3 18S,22S,24S,52S,80S Abgasnorm: Euro5/Euro6 / Exhaust Emission Norm: Euro5/Euro6	(7)
					für Fahrzeuge mit Zweischeibenkupplung / for vehicles with double disc clutch	(77)
					enthält eine Kupplungsscheibe / This part number includes one clutch disc	(66)
			 1878 002 643	400 10 400WGTZ	Getr. / GBox: ZF Ecosplit-3 18S,22S,24S,52S,80S Abgasnorm: Euro5/Euro6 / Exhaust Emission Norm: Euro5/Euro6	(7)
					für Fahrzeuge mit Zweischeibenkupplung / for vehicles with double disc clutch	(77)
			 3151 262 031	KZISZ-5	Getr. / GBox: ZF Ecosplit-3 18S,22S,24S,52S,80S Abgasnorm: Euro5/Euro6 / Exhaust Emission Norm: Euro5/Euro6	(7)
					für Fahrzeuge mit Zweischeibenkupplung / for vehicles with double disc clutch	(77)
			 3496 006 000		Getr. / GBox: ZF 18S,22S,24S,52S,80S Abgasnorm: Euro5/Euro6 / Exhaust Emission Norm: Euro5/Euro6	(7)
					langer Bügel / long handle	(86)
			 1863 869 038		Getr. / GBox: ZF 18S,22S,24S,52S,80S Abgasnorm: Euro5/Euro6 / Exhaust Emission Norm: Euro5/Euro6	(7)





















		CODE				
--	--	------	--	---	---	---

MAN

TGS		08.07 -					
18.320 FC, FLC, FLRC, FLLC, FLLRC, FLLW, FLLW/N 10S 06S 03S 15S 18.320 FK, FK-L, FLK, FLK/M 06S 03S 18.320 FLS, FLS/M, FLS-TS, FLRS, FLRS/M, FLLS, FLLS/N, FLLRS 06S 08S 13S 10S 18.360 FK, FK-L, FLK, FLK/M 03S 06S 18.400 FC, FLC, FLRC, FLLC, FLLRC, FLLW, FLLW/N 03S 06S 10S 15S	10.07-	D2066LF42, D2066LF37, D2066LF28, D2066LF43, D2066LF41, D2066LF39, D2066LF38	 3400 700 380  3482 000 361  1878 080 037  3151 000 034	430 10 MFZ430 430WGTZ KZISZ-5	Getr. / GBox: ZF Ecosplit-3 03S, 06S, 10S, 13S Abgasnorm: Euro4/Euro5 / Exhaust Emission Norm: Euro4/Euro5 Abgasnorm: Euro 6 / Exhaust Emission Norm: Euro 6	(6) (4)	
	10.07-		 3400 700 381  3482 000 361  1878 080 037  3151 000 493	430 10 MFZ430 430WGTZ KZISZ-5	Getr. / GBox: ZF AS-Tronic 03S, 06S, 10S, 13S Abgasnorm: Euro4/Euro5 / Exhaust Emission Norm: Euro4/Euro5 Abgasnorm: Euro 6 / Exhaust Emission Norm: Euro 6 für Ausrückgabel mit Rollen / for release fork with rollers	(6) (4) (70)	
	10.07-		 3400 700 403  3482 000 361  1878 004 832  3151 000 144	430 10 MFZ430 430WGTZ KZISZ-5	Getr. / GBox: ZF AS-Tronic 03S, 06S, 10S, 13S Abgasnorm: Euro4/Euro5 / Exhaust Emission Norm: Euro4/Euro5 Abgasnorm: Euro 6 / Exhaust Emission Norm: Euro 6 für Ausrückgabel mit Nocken / for release fork with cams	(6) (4) (69)	
	10.07-		 3400 700 327  3482 114 031  1878 004 832  3151 263 031	430 10 GMFZ430N 430WGTZ KZIZ-6	Getr. / GBox: ZF Ecosplit-3 03S, 06S, 10S, 13S Abgasnorm: Euro 6 / Exhaust Emission Norm: Euro 6 Abgasnorm: Euro4/Euro5 / Exhaust Emission Norm: Euro4/Euro5 für Fahrzeuge mit Nebenantrieb / for vehicles with PTO für Nebenantrieb / for PTO	(4) (6) (73) (82)	
				 3488 017 447	400 MFZ2/400X	Getr. / GBox: ZF Ecosplit-3 03S, 06S, 10S, 13S Abgasnorm: Euro4/Euro5 / Exhaust Emission Norm: Euro4/Euro5 Abgasnorm: Euro 6 / Exhaust Emission Norm: Euro 6 für Fahrzeuge mit Zweischeibenkupplung / for vehicles with double disc clutch enthält eine Kupplungsscheibe / This part number includes one clutch disc	(6) (4) (77) (66)
				 1878 002 643	400 10 400WGTZ	Getr. / GBox: ZF Ecosplit-3 03S, 06S, 10S, 13S Abgasnorm: Euro4/Euro5 / Exhaust Emission Norm: Euro4/Euro5 Abgasnorm: Euro 6 / Exhaust Emission Norm: Euro 6 für Fahrzeuge mit Zweischeibenkupplung / for vehicles with double disc clutch	(6) (4) (77)
				 3151 262 031	KZISZ-5	Getr. / GBox: ZF Ecosplit-3 03S, 06S, 10S, 13S Abgasnorm: Euro4/Euro5 / Exhaust Emission Norm: Euro4/Euro5 Abgasnorm: Euro 6 / Exhaust Emission Norm: Euro 6 für Fahrzeuge mit Zweischeibenkupplung / for vehicles with double disc clutch	(6) (4) (77)
				 3496 006 000		Getr. / GBox: ZF 03S, 06S, 10S, 13S Abgasnorm: Euro4/Euro5 / Exhaust Emission Norm: Euro4/Euro5 Abgasnorm: Euro 6 / Exhaust Emission Norm: Euro 6 langer Bügel / long handle	(6) (4) (86)
				 1863 869 038		Getr. / GBox: ZF 03S, 06S, 10S, 13S Abgasnorm: Euro4/Euro5 / Exhaust Emission Norm: Euro4/Euro5 Abgasnorm: Euro 6 / Exhaust Emission Norm: Euro 6	(6) (4)



















































		CODE				
--	--	------	--	---	---	---

MAN

TGS		08.07 -				
18.360 FC, FLC, FLRC, FLLC, FLLRC, FLLW, FLLW/N 06S 03S 10S 15S 18.360 FLS, FLS/M, FLS-TS, FLRS, FLRS/M, FLLS, FLLS/N, FLLRS 08S 13S 06S 10S 18.400 FK, FK-L, FLK, FLK/M 03S 06S 18.400 FLS, FLS/M, FLS-TS, FLRS, FLRS/M, FLLS, FLLS/N, FLLRS 06S 08S 10S 13S	10.07 -	D2066LF27, D2066LF42, D2066LF37, D2066LF41, D2066LF26, D2066LF38	 3400 700 380  3482 000 361  1878 080 037  3151 000 034	430 10 MFZ430 430WGTZ KZISZ-5	Getr. / GBox: ZF Ecosplit-3 03S,06S,10S,13S,24S Abgasnorm: Euro4/Euro5 / Exhaust Emission Norm: Euro4/Euro5 Abgasnorm: Euro 6 / Exhaust Emission Norm: Euro 6	(6) (4)
	10.07 -		 3400 700 381  3482 000 361  1878 080 037  3151 000 493	430 10 MFZ430 430WGTZ KZISZ-5	Getr. / GBox: ZF AS-Tronic 03S,06S,10S,13S,24S Abgasnorm: Euro4/Euro5 / Exhaust Emission Norm: Euro4/Euro5 Abgasnorm: Euro 6 / Exhaust Emission Norm: Euro 6 für Ausrückgabel mit Rollen / for release fork with rollers	(6) (4) (70)
	10.07 -		 3400 700 403  3482 000 361  1878 004 832  3151 000 144	430 10 MFZ430 430WGTZ KZISZ-5	Getr. / GBox: ZF AS-Tronic 03S,06S,10S,13S,24S Abgasnorm: Euro4/Euro5 / Exhaust Emission Norm: Euro4/Euro5 Abgasnorm: Euro 6 / Exhaust Emission Norm: Euro 6 für Ausrückgabel mit Nocken / for release fork with cams	(6) (4) (69)
	10.07 -		 3400 700 327  3482 114 031  1878 004 832  3151 263 031	430 10 GMFZ430N 430WGTZ KZISZ-6	Getr. / GBox: ZF Ecosplit-3 03S,06S,10S,13S,24S Abgasnorm: Euro4/Euro5 / Exhaust Emission Norm: Euro4/Euro5 Abgasnorm: Euro 6 / Exhaust Emission Norm: Euro 6 für Fahrzeuge mit Nebenantrieb / for vehicles with PTO für Nebenantrieb / for PTO	(6) (4) (73) (82)
			 3488 017 447	400 MFZ2/400X	Getr. / GBox: ZF Ecosplit-3 03S,06S,10S,13S,24S Abgasnorm: Euro4/Euro5 / Exhaust Emission Norm: Euro4/Euro5 Abgasnorm: Euro 6 / Exhaust Emission Norm: Euro 6 für Fahrzeuge mit Zweischeibenkupplung / for vehicles with double disc clutch enthält eine Kupplungsscheibe / This part number includes one clutch disc	(6) (4) (77) (66)
			 1878 002 643	400 10 400WGTZ	Getr. / GBox: ZF Ecosplit-3 03S,06S,10S,13S,24S Abgasnorm: Euro4/Euro5 / Exhaust Emission Norm: Euro4/Euro5 Abgasnorm: Euro 6 / Exhaust Emission Norm: Euro 6 für Fahrzeuge mit Zweischeibenkupplung / for vehicles with double disc clutch	(6) (4) (77)
			 3151 262 031	KZISZ-5	Getr. / GBox: ZF Ecosplit-3 03S,06S,10S,13S,24S Abgasnorm: Euro4/Euro5 / Exhaust Emission Norm: Euro4/Euro5 Abgasnorm: Euro 6 / Exhaust Emission Norm: Euro 6 für Fahrzeuge mit Zweischeibenkupplung / for vehicles with double disc clutch	(6) (4) (77)
			 3496 006 000		Getr. / GBox: ZF 03S,06S,10S,13S,24S Abgasnorm: Euro4/Euro5 / Exhaust Emission Norm: Euro4/Euro5 Abgasnorm: Euro 6 / Exhaust Emission Norm: Euro 6 langer Bügel / long handle	(6) (4) (86)
			 1863 869 038		Getr. / GBox: ZF 03S,06S,10S,13S,24S Abgasnorm: Euro4/Euro5 / Exhaust Emission Norm: Euro4/Euro5 Abgasnorm: Euro 6 / Exhaust Emission Norm: Euro 6	(6) (4)



















		CODE				
--	--	------	--	---	---	---

MAN

TGS		08.07 -				
18.440 FAC, FHLC 22S 52S 18.440 FAK, FAK-L, FALK, FALK-L, FHLK, FHLK/M 52S 80S 22S 18.440 FAS, FALS, FHLS, FHLS/M 52S 80S 22S	10.07-	D2066LF25, D2066LF36, D2066LF40	 3400 700 402  3482 000 246  1878 002 139  3151 000 034	430 10 MFZ430 430WGTZ KZISZ-5	Getr. / GBox: ZF Ecosplit 3 52S,80S	
	10.07-		 3400 700 460 HD  3482 000 246  1878 004 104  3151 000 034	430 10 MFZ430 430WGTZ KZISZ-5	Getr. / GBox: ZF Ecosplit 3 52S,80S	
	10.07-		 3400 700 381  3482 000 361  1878 080 037  3151 000 493	430 10 MFZ430 430WGTZ KZISZ-5	Getr. / GBox: ZF AS-Tronic 52S,80S für Ausrückgabel mit Rollen / for release fork with rollers	(70)
			 3400 700 403  3482 000 361  1878 004 832  3151 000 144	430 10 MFZ430 430WGTZ KZISZ-5	Getr. / GBox: ZF AS-Tronic 52S,80S für Ausrückgabel mit Nocken / for release fork with cams	(69)
			 3400 700 327  3482 114 031  1878 004 832  3151 263 031	430 10 GMFZ430N 430WGTZ KZISZ-6	Getr. / GBox: ZF Ecosplit 3 52S,80S für Fahrzeuge mit Nebenantrieb / for vehicles with PTO für Nebenantrieb / for PTO	(73) (82)
			 3488 017 447	400 MFZ2/400X	Getr. / GBox: ZF Ecosplit 3 52S,80S für Fahrzeuge mit Zweischeibenkupplung / for vehicles with double disc clutch enthält eine Kupplungsscheibe / This part number includes one clutch disc	(77) (66)
			 1878 002 643	400 10 400WGTZ	Getr. / GBox: ZF Ecosplit 3 52S,80S für Fahrzeuge mit Zweischeibenkupplung / for vehicles with double disc clutch	(77)
			 3151 262 031	KZISZ-5	Getr. / GBox: ZF Ecosplit 3 52S,80S für Fahrzeuge mit Zweischeibenkupplung / for vehicles with double disc clutch	(77)
			 3496 006 000		52S,80S langer Bügel / long handle	(86)
			 1863 869 038		52S,80S	
18.440 FC, FLC, FLRC, FLLC, FLLRC, FLLW, FLLW/N 06S 15S 03S 10S 18.440 FK, FK-L, FLK, FLK/M 03S 06S 18.440 FLS, FLS/M, FLS-TS, FLRS, FLRS/M, FLLS, FLLS/N, FLLRS 10S 13S 08S 06S 24.440 FPLS, FPLRS 24S	10.07-	D2066LF25EUR O5, D2066LF36EUR O4	 3400 700 402  3482 000 246  1878 002 139  3151 000 034	430 10 MFZ430 430WGTZ KZISZ-5	Getr. / GBox: ZF Ecosplit-3 03S,06S,10S,13S,24S	
	10.07-		 3400 700 460 HD  3482 000 246  1878 004 104  3151 000 034	430 10 MFZ430 430WGTZ KZISZ-5	Getr. / GBox: ZF Ecosplit-3 03S,06S,10S,13S,24S	
	10.07-		 3400 700 381  3482 000 361  1878 080 037  3151 000 493	430 10 MFZ430 430WGTZ KZISZ-5	Getr. / GBox: ZF AS-Tronic 03S,06S,10S,13S,24S für Ausrückgabel mit Rollen / for release fork with rollers	(70)
	10.07-		 3400 700 403  3482 000 361  1878 004 832  3151 000 144	430 10 MFZ430 430WGTZ KZISZ-5	Getr. / GBox: ZF AS-Tronic 03S,06S,10S,13S,24S für Ausrückgabel mit Nocken / for release fork with cams	(69)
			 3400 700 327  3482 114 031  1878 004 832  3151 263 031	430 10 GMFZ430N 430WGTZ KZISZ-6	Getr. / GBox: ZF Ecosplit-3 03S,06S,10S,13S,24S für Fahrzeuge mit Nebenantrieb / for vehicles with PTO für Nebenantrieb / for PTO	(73) (82)
			 3488 017 447	400 MFZ2/400X	Getr. / GBox: ZF Ecosplit-3 03S,06S,10S,13S,24S für Fahrzeuge mit Zweischeibenkupplung / for vehicles with double disc clutch enthält eine Kupplungsscheibe / This part number includes one clutch disc	(77) (66)
			 1878 002 643	400 10 400WGTZ	Getr. / GBox: ZF Ecosplit-3 03S,06S,10S,13S,24S für Fahrzeuge mit Zweischeibenkupplung / for vehicles with double disc clutch	(77)
			 3151 262 031	KZISZ-5	Getr. / GBox: ZF Ecosplit-3 03S,06S,10S,13S,24S für Fahrzeuge mit Zweischeibenkupplung / for vehicles with double disc clutch	(77)
			 3496 006 000		Getr. / GBox: ZF 03S,06S,10S,13S,24S langer Bügel / long handle	(86)
			 1863 869 038		Getr. / GBox: ZF 03S,06S,10S,13S,24S	

























		CODE				
--	--	------	--	---	---	---











































MAN

TGS		08.07 -				
18.480 FAC, FHLC 22S 52S 18.480 FAK, FAK-L, FALK, FALK-L, FHLK, FHLK/M 80S 52S 22S 18.480 FAS, FALS, FHLS 80S 52S 22S	10.07 -	D2676LF07, D2676LF05		3400 700 460 HD  3482 000 246  1878 004 104  3151 000 034	430 10 MFZ430 430WGTZ KZISZ-5	Getr. / GBox: ZF Ecosplit 3 52S,80S Abgasnorm: Euro5/Euro6 / Exhaust Emission Norm: Euro5/Euro6 (7)
	10.07 -			3400 700 459 HD  3482 000 246  1878 004 104  3151 000 493	430 10 MFZ430 430WGTZ KZISZ-5	Getr. / GBox: ZF AS-Tronic 52S,80S Abgasnorm: Euro5/Euro6 / Exhaust Emission Norm: Euro5/Euro6 (7) für Ausrückgabel mit Rollen / for release fork with rollers (70)
	10.07 -			3151 000 144	KZISZ-5	Getr. / GBox: ZF AS-Tronic 52S,80S Abgasnorm: Euro5/Euro6 / Exhaust Emission Norm: Euro5/Euro6 (7) für Ausrückgabel mit Nocken / for release fork with cams (69)
				3400 700 327  3482 114 031  1878 004 832  3151 263 031	430 10 GMFZ430N 430WGTZ KZIZ-6	Getr. / GBox: ZF Ecosplit 3 52S,80S Abgasnorm: Euro5/Euro6 / Exhaust Emission Norm: Euro5/Euro6 (7) für Fahrzeuge mit Nebenantrieb / for vehicles with PTO (73) für Nebenantrieb / for PTO (82)
				3488 017 447	400 MFZ2/400X	Getr. / GBox: ZF Ecosplit 3 52S,80S Abgasnorm: Euro5/Euro6 / Exhaust Emission Norm: Euro5/Euro6 (7) für Fahrzeuge mit Zweischeibenkupplung / for vehicles with double disc clutch (77) enthält eine Kupplungsscheibe / This part number includes one clutch disc (66)
				1878 002 643	400 10 400WGTZ	Getr. / GBox: ZF Ecosplit 3 52S,80S Abgasnorm: Euro5/Euro6 / Exhaust Emission Norm: Euro5/Euro6 (7) für Fahrzeuge mit Zweischeibenkupplung / for vehicles with double disc clutch (77)
				3151 262 031	KZISZ-5	Getr. / GBox: ZF Ecosplit 3 52S,80S Abgasnorm: Euro5/Euro6 / Exhaust Emission Norm: Euro5/Euro6 (7) für Fahrzeuge mit Zweischeibenkupplung / for vehicles with double disc clutch (77)
				3496 006 000		52S,80S Abgasnorm: Euro5/Euro6 / Exhaust Emission Norm: Euro5/Euro6 (7) langer Bügel / long handle (86)
				1863 869 038		52S,80S Abgasnorm: Euro5/Euro6 / Exhaust Emission Norm: Euro5/Euro6 (7)

		CODE				
--	--	------	--	---	---	---





















MAN

TGS		08.07 -				
18.480 FC, FLC, FLRC, FLLC, FLLRC, FLLW, FLLW/N 10S 03S 06S 18.480 FK, FK-L, FLK, FLK/M 03S 06S 18.480 FLS, FLS/M, FLS-TS, FLRS, FLRS/M, FLLS, FLLS/N, FLLRS 06S 10S 13S 08S 24.480 FPLS, FPLRS 24S	10.07-	D2676LF07, D2676LF14, D2676LF05	 3400 700 402  3482 000 246  1878 002 139  3151 000 034	430 10 MFZ430 430WGTZ KZISZ-5	Getr. / GBox: ZF Ecosplit-3 03S,06S,08S,13S / 10S,18S,22S,24S Abgasnorm: Euro4/Euro5 / Exhaust Emission Norm: Euro4/Euro5 Abgasnorm: Euro 6 / Exhaust Emission Norm: Euro 6	(6) (4)
	10.07-		 3400 700 460 HD  3482 000 246  1878 004 104  3151 000 034	430 10 MFZ430 430WGTZ KZISZ-5	Getr. / GBox: ZF Ecosplit-3 03S,06S,08S,13S / 10S,18S,22S,24S Abgasnorm: Euro4/Euro5 / Exhaust Emission Norm: Euro4/Euro5 Abgasnorm: Euro 6 / Exhaust Emission Norm: Euro 6	(6) (4)
	10.07-		 3400 700 459 HD  3482 000 246  1878 004 104  3151 000 493	430 10 MFZ430 430WGTZ KZISZ-5	Getr. / GBox: ZF AS-Tronic 03S,06S,08S,13S / 10S,18S,22S,24S Abgasnorm: Euro 6 / Exhaust Emission Norm: Euro 6 Abgasnorm: Euro4/Euro5 / Exhaust Emission Norm: Euro4/Euro5 für Ausrückgabel mit Rollen / for release fork with rollers	(4) (6) (70)
	10.07-		 3400 700 404  3482 000 246  1878 002 139  3151 000 144	430 10 MFZ430 430WGTZ KZISZ-5	Getr. / GBox: ZF AS-Tronic 03S,06S,08S,13S / 10S,18S,22S,24S Abgasnorm: Euro4/Euro5 / Exhaust Emission Norm: Euro4/Euro5 Abgasnorm: Euro 6 / Exhaust Emission Norm: Euro 6 für Ausrückgabel mit Nocken / for release fork with cams	(6) (4) (69)
			 3400 700 327  3482 114 031  1878 004 832  3151 263 031	430 10 GMFZ430N 430WGTZ KZIZ-6	Getr. / GBox: ZF Ecosplit-3 03S,06S,08S,13S / 10S,18S,22S,24S Abgasnorm: Euro4/Euro5 / Exhaust Emission Norm: Euro4/Euro5 Abgasnorm: Euro 6 / Exhaust Emission Norm: Euro 6 für Fahrzeuge mit Nebenantrieb / for vehicles with PTO für Nebenantrieb / for PTO	(6) (4) (73) (82)
			 3488 017 447	400 MFZZ/400X	Getr. / GBox: ZF Ecosplit-3 03S,06S,08S,13S / 10S,18S,22S,24S Abgasnorm: Euro4/Euro5 / Exhaust Emission Norm: Euro4/Euro5 Abgasnorm: Euro 6 / Exhaust Emission Norm: Euro 6 für Fahrzeuge mit Zweischeibenkupplung / for vehicles with double disc clutch enthält eine Kupplungsscheibe / This part number includes one clutch disc	(6) (4) (77) (66)
			 1878 002 643	400 10 400WGTZ	Getr. / GBox: ZF Ecosplit-3 03S,06S,08S,13S / 10S,18S,22S,24S Abgasnorm: Euro4/Euro5 / Exhaust Emission Norm: Euro4/Euro5 Abgasnorm: Euro 6 / Exhaust Emission Norm: Euro 6 für Fahrzeuge mit Zweischeibenkupplung / for vehicles with double disc clutch	(6) (4) (77)
			 3151 262 031	KZISZ-5	Getr. / GBox: ZF Ecosplit-3 03S,06S,08S,13S / 10S,18S,22S,24S Abgasnorm: Euro4/Euro5 / Exhaust Emission Norm: Euro4/Euro5 Abgasnorm: Euro 6 / Exhaust Emission Norm: Euro 6 für Fahrzeuge mit Zweischeibenkupplung / for vehicles with double disc clutch	(6) (4) (77)
			 3496 006 000		Getr. / GBox: ZF 03S,06S,08S,13S / 10S,18S,22S,24S Abgasnorm: Euro4/Euro5 / Exhaust Emission Norm: Euro4/Euro5 Abgasnorm: Euro 6 / Exhaust Emission Norm: Euro 6 langer Bügel / long handle	(6) (4) (86)
			 1863 869 038		Getr. / GBox: ZF 03S,06S,08S,13S / 10S,18S,22S,24S Abgasnorm: Euro4/Euro5 / Exhaust Emission Norm: Euro4/Euro5 Abgasnorm: Euro 6 / Exhaust Emission Norm: Euro 6	(6) (4)

TGS		08.07 -					
18.540 FAC, FHLC 22S 52S 18.540 FAK, FAK-L, FALK, FALK-L, FHLK, FHLK/M 80S 52S 22S 18.540 FAS, FALS, FHLS, FHLS/M 22S 80S 52S	10.07-	D2676LF13, D2676LF06	 3400 700 460 HD  3482 000 246  1878 004 104  3151 000 034	430 10 MFZ430 430WGTZ KZISZ-5	Getr. / GBox: ZF Ecosplit 3 52S,80S		
	10.07-		 3400 700 459 HD  3482 000 246  1878 004 104  3151 000 493	430 10 MFZ430 430WGTZ KZISZ-5	Getr. / GBox: ZF AS-Tronic 52S,80S für Ausrückgabel mit Rollen / for release fork with rollers	(70)	
	10.07-		 3151 000 144	KZISZ-5	Getr. / GBox: ZF AS-Tronic 52S,80S für Ausrückgabel mit Nocken / for release fork with cams	(69)	
			 3400 700 327  3482 114 031  1878 004 832  3151 263 031	430 10 GMFZ430N 430WGTZ KZISZ-6	Getr. / GBox: ZF Ecosplit 3 52S,80S für Fahrzeuge mit Nebenantrieb / for vehicles with PTO für Nebenantrieb / for PTO	(73) (82)	
			 3488 017 447	400 MFZ2/400X	Getr. / GBox: ZF Ecosplit 3 52S,80S für Fahrzeuge mit Zweischeibenkupplung / for vehicles with double disc clutch enthält eine Kupplungsscheibe / This part number includes one clutch disc	(77) (66)	
			 1878 002 643	400 10 400WGTZ	Getr. / GBox: ZF Ecosplit 3 52S,80S für Fahrzeuge mit Zweischeibenkupplung / for vehicles with double disc clutch	(77)	
			 3151 262 031	KZISZ-5	Getr. / GBox: ZF Ecosplit 3 52S,80S für Fahrzeuge mit Zweischeibenkupplung / for vehicles with double disc clutch	(77)	
			 3496 006 000		52S,80S langer Bügel / long handle	(86)	
			 1863 869 038		52S,80S		
	18.540 FC, FLC, FLRC, FLLC, FLLRC, FLLW, FLLW/N 10S 03S 06S 18.540 FK, FK-L, FLK, FLK/M 03S 06S 18.540 FLS, FLS/M, FLRS, FLRS/M, FLLS, FLLS/N, FLLRS 06S 10S 08S 24.540 FPLS, FPLRS 24S 26.540 FNLK, FNLRC, FNLLC, FNLLRC, FNLLW, FVLC, FVL-KO 24S 18S 21S 26.540 FNLS, FNLLS, FPLS, FPLRS, FVLS 21S 24S 18S		10.07-	D2676LF13EUR O5	 3400 700 402  3482 000 246  1878 002 139  3151 000 034	430 10 MFZ430 430WGTZ KZISZ-5	Getr. / GBox: ZF Ecosplit-3 03S,06S,08S,10S / 18S,22S,24S
10.07-		 3400 700 460 HD  3482 000 246  1878 004 104  3151 000 034	430 10 MFZ430 430WGTZ KZISZ-5		Getr. / GBox: ZF Ecosplit-3 03S,06S,08S,10S / 18S,22S,24S		
10.07-		 3400 700 459 HD  3482 000 246  1878 004 104  3151 000 493	430 10 MFZ430 430WGTZ KZISZ-5		Getr. / GBox: ZF AS-Tronic 03S,06S,08S,10S / 18S,22S,24S für Ausrückgabel mit Rollen / for release fork with rollers	(70)	
10.07-		 3400 700 404  3482 000 246  1878 002 139  3151 000 144	430 10 MFZ430 430WGTZ KZISZ-5		Getr. / GBox: ZF AS-Tronic 03S,06S,08S,10S / 18S,22S,24S für Ausrückgabel mit Nocken / for release fork with cams	(69)	
10.07-		 3400 700 327  3482 114 031  1878 004 832  3151 263 031	430 10 GMFZ430N 430WGTZ KZISZ-6		Getr. / GBox: ZF Ecosplit-3 03S,06S,08S,10S / 18S,22S,24S für Fahrzeuge mit Nebenantrieb / for vehicles with PTO für Nebenantrieb / for PTO	(73) (82)	
02.09-		 3488 017 447	400 MFZ2/400X		Getr. / GBox: ZF Ecosplit-3 03S,06S,08S,10S / 18S,22S,24S für Fahrzeuge mit Zweischeibenkupplung / for vehicles with double disc clutch enthält eine Kupplungsscheibe / This part number includes one clutch disc	(77) (66)	
		 1878 002 643	400 10 400WGTZ		Getr. / GBox: ZF Ecosplit-3 03S,06S,08S,10S / 18S,22S,24S für Fahrzeuge mit Zweischeibenkupplung / for vehicles with double disc clutch	(77)	
		 3151 262 031	KZISZ-5		Getr. / GBox: ZF Ecosplit-3 03S,06S,08S,10S / 18S,22S,24S für Fahrzeuge mit Zweischeibenkupplung / for vehicles with double disc clutch	(77)	
		 3496 006 000			Getr. / GBox: ZF 03S,06S,08S,10S / 18S,22S,24S langer Bügel / long handle	(86)	
		 1863 869 038			Getr. / GBox: ZF 03S,06S,08S,10S / 18S,22S,24S		















































		CODE				
--	--	------	--	---	---	---

MAN

TGS		08.07 -					
24.320 FNLLW/N 45S 24.360 FNLLW/N 45S 24.400 FNLLW/N 45S 26.400 FNLS, FNLRS, FNLLS, FNLLRS, FPLS, FPLRS, FVLS 21S 18S 24S	10.07-	D2066LF37, D2066LF28, D2066LF43, D2066LF27, D2066LF42, D2066LF41, D2066LF26, D2066LF38	 3400 700 380  3482 000 361  1878 080 037  3151 000 034	430 10 MFZ430 430WGTZ KZISZ-5	Getr. / GBox: ZF Ecosplit-3 21S,42S,45S Abgasnorm: Euro5/Euro6 / Exhaust Emission Norm: Euro5/Euro6 Abgasnorm: Euro 6 / Exhaust Emission Norm: Euro 6	(7) (4)	
	10.07-		 3400 700 381  3482 000 361  1878 080 037  3151 000 493	430 10 MFZ430 430WGTZ KZISZ-5	Getr. / GBox: ZF AS-Tronic 21S,42S,45S Abgasnorm: Euro5/Euro6 / Exhaust Emission Norm: Euro5/Euro6 Abgasnorm: Euro 6 / Exhaust Emission Norm: Euro 6 für Ausrückgabel mit Rollen / for release fork with rollers	(7) (4) (70)	
	10.07-		 3400 700 403  3482 000 361  1878 004 832  3151 000 144	430 10 MFZ430 430WGTZ KZISZ-5	Getr. / GBox: ZF AS-Tronic 21S,42S,45S Abgasnorm: Euro5/Euro6 / Exhaust Emission Norm: Euro5/Euro6 Abgasnorm: Euro 6 / Exhaust Emission Norm: Euro 6 für Ausrückgabel mit Nocken / for release fork with cams	(7) (4) (69)	
	02.09-		 3400 700 327  3482 114 031  1878 004 832  3151 263 031	430 10 GMFZ430N 430WGTZ KZISZ-6	Getr. / GBox: ZF Ecosplit-3 21S,42S,45S Abgasnorm: Euro5/Euro6 / Exhaust Emission Norm: Euro5/Euro6 Abgasnorm: Euro 6 / Exhaust Emission Norm: Euro 6 für Fahrzeuge mit Nebenantrieb / for vehicles with PTO für Nebenantrieb / for PTO	(7) (4) (73) (82)	
				 3488 017 447	400 MFZ2/400X	Getr. / GBox: ZF Ecosplit-3 21S,42S,45S Abgasnorm: Euro5/Euro6 / Exhaust Emission Norm: Euro5/Euro6 Abgasnorm: Euro 6 / Exhaust Emission Norm: Euro 6 für Fahrzeuge mit Zweischeibenkupplung / for vehicles with double disc clutch enthält eine Kupplungsscheibe / This part number includes one clutch disc	(7) (4) (77) (66)
				 1878 002 643	400 10 400WGTZ	Getr. / GBox: ZF Ecosplit-3 21S,42S,45S Abgasnorm: Euro5/Euro6 / Exhaust Emission Norm: Euro5/Euro6 Abgasnorm: Euro 6 / Exhaust Emission Norm: Euro 6 für Fahrzeuge mit Zweischeibenkupplung / for vehicles with double disc clutch	(7) (4) (77)
				 3151 262 031	KZISZ-5	Getr. / GBox: ZF Ecosplit-3 21S,42S,45S Abgasnorm: Euro5/Euro6 / Exhaust Emission Norm: Euro5/Euro6 Abgasnorm: Euro 6 / Exhaust Emission Norm: Euro 6 für Fahrzeuge mit Zweischeibenkupplung / for vehicles with double disc clutch	(7) (4) (77)
				 3496 006 000		Getr. / GBox: ZF 21S,42S,45S Abgasnorm: Euro5/Euro6 / Exhaust Emission Norm: Euro5/Euro6 Abgasnorm: Euro 6 / Exhaust Emission Norm: Euro 6 langer Bügel / long handle	(7) (4) (86)
				 1863 869 038		Getr. / GBox: ZF 21S,42S,45S Abgasnorm: Euro5/Euro6 / Exhaust Emission Norm: Euro5/Euro6 Abgasnorm: Euro 6 / Exhaust Emission Norm: Euro 6	(7) (4)





















		CODE				
--	--	------	--	---	---	---

MAN

TGS		08.07 -				
24.360 FPLS, FPLRS 24S 24.400 FPLS, FPLRS 24S 26.320 FNLC, FNLCR, FNLLC, FNLLRC, FNLLW, FVLC, FVL-KO 24S 21S 18S 26.320 FNLS, FNLSR, FNLLS, FPLS, FVLS 21S 24S 18S 26.360 FNLC, FNLCR, FNLLC, FNLLRC, FVLC, FVL-KO 21S 24S 18S 26.360 FNLS, FNLLS, FNLSR, FPLS, FPLRS, FVLS 24S 21S 18S 26.400 FNLC, FNLCR, FNLLC, FNLLRC, FVLC, FVL-KO, FNLLW 21S 24S 18S	10.07 -	D2066LF43, D2066LF42, D2066LF28, D2066LF27, D2066LF37, D2066LF39, D2066LF41, D2066LF26, D2066LF38	 3400 700 380  3482 000 361  1878 080 037  3151 000 034	430 10 MFZ430 430WGTZ KZISZ-5	Getr. / GBox: ZF Ecosplit-3 06S,10S,18S,22S,24S Abgasnorm: Euro4/Euro5 / Exhaust Emission Norm: Euro4/Euro5 Abgasnorm: Euro 6 / Exhaust Emission Norm: Euro 6	(6)
	10.07 -		 3400 700 381  3482 000 361  1878 080 037  3151 000 493	430 10 MFZ430 430WGTZ KZISZ-5	Getr. / GBox: ZF AS-Tronic 06S,10S,18S,22S,24S für Ausrückgabel mit Rollen / for release fork with rollers	(70)
	07.08 -		 3400 700 403  3482 000 361  1878 004 832  3151 000 144	430 10 MFZ430 430WGTZ KZISZ-5	Getr. / GBox: ZF AS-Tronic 06S,10S,18S,22S,24S für Ausrückgabel mit Nocken / for release fork with cams	(69)
	10.07 -		 3400 700 327  3482 114 031  1878 004 832  3151 263 031	430 10 GMFZ430N 430WGTZ KZISZ-6	Getr. / GBox: ZF Ecosplit-3 06S,10S,18S,22S,24S für Fahrzeuge mit Nebenantrieb / for vehicles with PTO	(73)
	08.08 -		 3488 017 447	400 MFZ2/400X	Getr. / GBox: ZF Ecosplit-3 06S,10S,18S,22S,24S für Fahrzeuge mit Zweischeibenkupplung / for vehicles with double disc clutch enthält eine Kupplungsscheibe / This part number includes one clutch disc	(77)
	10.07 -		 1878 002 643	400 10 400WGTZ	Getr. / GBox: ZF Ecosplit-3 06S,10S,18S,22S,24S für Fahrzeuge mit Zweischeibenkupplung / for vehicles with double disc clutch	(77)
			 3151 262 031	KZISZ-5	Getr. / GBox: ZF Ecosplit-3 06S,10S,18S,22S,24S für Fahrzeuge mit Zweischeibenkupplung / for vehicles with double disc clutch	(77)
			 3496 006 000		Getr. / GBox: ZF 06S,10S,18S,22S,24S langer Bügel / long handle	(86)
			 1863 869 038		Getr. / GBox: ZF 06S,10S,18S,22S,24S	
	24.440 FNLLW/N 45S 26.440 FNLC, FNLLC, FNLLW, FNLCR, FNLLRC, FVLC, FVL-KO 24S 18S 21S 26.440 FNLS, FNLLS, FNLSR, FPLS, FPLRS, FVLS 18S 21S 24S		10.07 -	D2066LF25EUR O5, D2066LF36EUR O4	 3400 700 402  3482 000 246  1878 002 139  3151 000 034	430 10 MFZ430 430WGTZ KZISZ-5
10.07 -		 3400 700 460 HD  3482 000 246  1878 004 104  3151 000 034	430 10 MFZ430 430WGTZ KZISZ-5		Getr. / GBox: ZF Ecosplit-3	
02.09 -		 3400 700 381  3482 000 361  1878 080 037  3151 000 493	430 10 MFZ430 430WGTZ KZISZ-5		Getr. / GBox: ZF AS-Tronic für Ausrückgabel mit Rollen / for release fork with rollers	(70)
		 3400 700 403  3482 000 361  1878 004 832  3151 000 144	430 10 MFZ430 430WGTZ KZISZ-5		Getr. / GBox: ZF AS-Tronic für Ausrückgabel mit Nocken / for release fork with cams	(69)
10.07 -		 3400 700 327  3482 114 031  1878 004 832  3151 263 031	430 10 GMFZ430N 430WGTZ KZISZ-6		Getr. / GBox: ZF Ecosplit-3 für Fahrzeuge mit Nebenantrieb / for vehicles with PTO	(73)
		 3488 017 447	400 MFZ2/400X		Getr. / GBox: ZF Ecosplit-3 für Fahrzeuge mit Zweischeibenkupplung / for vehicles with double disc clutch enthält eine Kupplungsscheibe / This part number includes one clutch disc	(77)
		 1878 002 643	400 10 400WGTZ		Getr. / GBox: ZF Ecosplit-3 für Fahrzeuge mit Zweischeibenkupplung / for vehicles with double disc clutch	(77)
		 3151 262 031	KZISZ-5		Getr. / GBox: ZF Ecosplit-3 für Fahrzeuge mit Zweischeibenkupplung / for vehicles with double disc clutch	(77)
10.07 -		 3496 006 000			Getr. / GBox: ZF langer Bügel / long handle	(86)
10.07 -		 1863 869 038			Getr. / GBox: ZF	





















		CODE		 Parameter		
--	--	------	--	---	---	---

MAN

TGS		08.07 -					
26.320 FDAC, FDALC, FDHLC, FDHLC/M 70S 82S 56S 26.320 FDAK, FDALK, FDHK, FDHLK 47S 56S 82S 70S 26.320 FDAS, FDALS, FDHS, FDHLS, FDHLS/M 82S 70S 56S 47S 26.360 FDAC, FDALC, FDHLC, FDHLC/M 56S 70S 82S 26.360 FDAK, FDALK, FDHK, FDHLK 70S 47S 82S 56S 26.360 FDAS, FDALS, FDHS, FDHLS, FDHLS/M 47S 82S 56S 70S 26.400 FDAC, FDALC, FDHLC, FDHLC/M 70S 56S 82S 26.400 FDAK, FDALK, FDHK, FDHLK 56S 70S 47S 82S 26.400 FDAS, FDALS, FDHS, FDHLS, FDHLS/M 56S 70S 47S 82S 33.360 FDAC, FDALC 56S 82S 33.360 FDAK, FDALK, FDHK 47S 82S 56S 33.360 FDAS, FDALS, FDHS 47S 56S 82S 33.400 FDAC, FDALC 56S 33.400 FDAK, FDALK, FDHK 56S 47S 33.400 FDAS, FDALS, FDHS 56S 47S	07.08-	D2066LF43, D2066LF42, D2066LF37, D2066LF27, D2066LF39, D2066LF41, D2066LF26, D2066LF38	 3400 700 380  3482 000 361  1878 080 037  3151 000 034	430 10 MFZ430 430WGTZ KZISZ-5	Getr. / GBox: ZF Ecosplit-3 56S,70S,82S Abgasnorm: Euro5/Euro6 / Exhaust Emission Norm: Euro5/Euro6	(7)	
		07.08-		 3400 700 381  3482 000 361  1878 080 037  3151 000 493	430 10 MFZ430 430WGTZ KZISZ-5	Getr. / GBox: ZF AS-Tronic 56S,70S,82S Abgasnorm: Euro5/Euro6 / Exhaust Emission Norm: Euro5/Euro6 für Ausrückgabel mit Rollen / for release fork with rollers	(7) (70)
		08.08-		 3400 700 403  3482 000 361  1878 004 832  3151 000 144	430 10 MFZ430 430WGTZ KZISZ-5	Getr. / GBox: ZF AS-Tronic 56S,70S,82S Abgasnorm: Euro5/Euro6 / Exhaust Emission Norm: Euro5/Euro6 für Ausrückgabel mit Nocken / for release fork with cams	(7) (69)
		08.08-		 3400 700 327  3482 114 031  1878 004 832  3151 263 031	430 10 GMFZ430N 430WGTZ KZIZ-6	Getr. / GBox: ZF Ecosplit-3 56S,70S,82S Abgasnorm: Euro5/Euro6 / Exhaust Emission Norm: Euro5/Euro6 für Fahrzeuge mit Nebenantrieb / for vehicles with PTO für Nebenantrieb / for PTO	(7) (73) (82)
		11.07-		 3488 017 447	400 MFZ2/400X	Getr. / GBox: ZF Ecosplit-3 56S,70S,82S Abgasnorm: Euro5/Euro6 / Exhaust Emission Norm: Euro5/Euro6 für Fahrzeuge mit Zweischeibenkupplung / for vehicles with double disc clutch enthält eine Kupplungsscheibe / This part number includes one clutch disc	(7) (77) (66)
		06.08-		 1878 002 643	400 10 400WGTZ	Getr. / GBox: ZF Ecosplit-3 56S,70S,82S Abgasnorm: Euro5/Euro6 / Exhaust Emission Norm: Euro5/Euro6 für Fahrzeuge mit Zweischeibenkupplung / for vehicles with double disc clutch	(7) (77)
		10.07-		 3151 262 031	KZISZ-5	Getr. / GBox: ZF Ecosplit-3 56S,70S,82S Abgasnorm: Euro5/Euro6 / Exhaust Emission Norm: Euro5/Euro6 für Fahrzeuge mit Zweischeibenkupplung / for vehicles with double disc clutch	(7) (77)
		07.08-		 3496 006 000		Getr. / GBox: ZF 56S,70S,82S Abgasnorm: Euro5/Euro6 / Exhaust Emission Norm: Euro5/Euro6 langer Bügel / long handle	(7) (86)
		07.08-		 1863 869 038		Getr. / GBox: ZF 56S,70S,82S Abgasnorm: Euro5/Euro6 / Exhaust Emission Norm: Euro5/Euro6	(7)











































		CODE				
--	--	------	--	---	---	---

MAN

TGS		08.07 -				
26.320 FDC, FDRC, FDLC, FDLC/M, FDLRC, FDLRC/M, FNHLC 26S 35S 30S 26.320 FDK, FDLK 30S 26S 26.320 FDS, FDLS, FDLS/M, FDRS, FDLRS, FDLRS/M, FNHLS 26S 30S 35S 26.320 FD-TM 26S 26.360 FDC, FDRC, FDRC/M, FDLC, FDLRC, FNHLC 35S 26S 30S 26.360 FDK, FDLK, FDRK 26S 30S 26.360 FDS, FDRS, FDRS/M, FDLS, FDLRS, FNHLS 35S 30S 26S 26.360 FD-TM 26S 26.400 FDC, FDRC, FDC/M, FDLC, FDLC/M, FDLRC, FDLRC/M, FNHLC 30S 35S 26S 26.400 FDK, FDLK 26S 30S 26.400 FDS, FDS/M, FDLS, FDLS/M, FDRS, FDLRS, FNHLS 26S 35S 30S 26.400 FD-TM 26S 33.360 FDC, FDLC 30S 26S 33.360 FDK, FDLK 30S 26S 33.360 FDS, FDLS 26S 30S 33.400 FDC, FDLC 30S 26S 33.400 FDK, FDLK 26S 30S 33.400 FDS, FDLS 26S 30S	07.08 -	D2066LF43, D2066LF42, D2066LF37, D2066LF39, D2066LF41, D2066LF38	 3400 700 380  3482 000 361  1878 080 037  3151 000 034	430 10 MFZ430 430WGTZ KZISZ-5	Getr. / GBox: ZF Ecosplit-3 26S,30S,35S Abgasnorm: Euro4/Euro5 / Exhaust Emission Norm: Euro4/Euro5 Abgasnorm: Euro 6 / Exhaust Emission Norm: Euro 6	(6) (4)
	07.08 -		 3400 700 381  3482 000 361  1878 080 037  3151 000 493	430 10 MFZ430 430WGTZ KZISZ-5	Getr. / GBox: ZF AS-Tronic 26S,30S,35S Abgasnorm: Euro4/Euro5 / Exhaust Emission Norm: Euro4/Euro5 Abgasnorm: Euro 6 / Exhaust Emission Norm: Euro 6 für Ausrückgabel mit Rollen / for release fork with rollers	(6) (4) (70)
	07.08 -		 3400 700 403  3482 000 361  1878 004 832  3151 000 144	430 10 MFZ430 430WGTZ KZISZ-5	Getr. / GBox: ZF AS-Tronic 26S,30S,35S Abgasnorm: Euro4/Euro5 / Exhaust Emission Norm: Euro4/Euro5 Abgasnorm: Euro 6 / Exhaust Emission Norm: Euro 6 für Ausrückgabel mit Nocken / for release fork with cams	(6) (4) (69)
	08.08 -		 3400 700 327  3482 114 031  1878 004 832  3151 263 031	430 10 GMFZ430N 430WGTZ KZISZ-6	Getr. / GBox: ZF Ecosplit-3 26S,30S,35S Abgasnorm: Euro4/Euro5 / Exhaust Emission Norm: Euro4/Euro5 Abgasnorm: Euro 6 / Exhaust Emission Norm: Euro 6 für Fahrzeuge mit Nebenantrieb / for vehicles with PTO für Nebenantrieb / for PTO	(6) (4) (73) (82)
	08.08 -		 3488 017 447	400 MFZ2/400X	Getr. / GBox: ZF Ecosplit-3 26S,30S,35S Abgasnorm: Euro4/Euro5 / Exhaust Emission Norm: Euro4/Euro5 Abgasnorm: Euro 6 / Exhaust Emission Norm: Euro 6 für Fahrzeuge mit Zweis Scheibenkupplung / for vehicles with double disc clutch enthält eine Kupplungsscheibe / This part number includes one clutch disc	(6) (4) (77) (66)
	02.09 -		 1878 002 643	400 10 400WGTZ	Getr. / GBox: ZF Ecosplit-3 26S,30S,35S Abgasnorm: Euro4/Euro5 / Exhaust Emission Norm: Euro4/Euro5 Abgasnorm: Euro 6 / Exhaust Emission Norm: Euro 6 für Fahrzeuge mit Zweis Scheibenkupplung / for vehicles with double disc clutch	(6) (4) (77)
	02.09 -		 3151 262 031	KZISZ-5	Getr. / GBox: ZF Ecosplit-3 26S,30S,35S Abgasnorm: Euro4/Euro5 / Exhaust Emission Norm: Euro4/Euro5 Abgasnorm: Euro 6 / Exhaust Emission Norm: Euro 6 für Fahrzeuge mit Zweis Scheibenkupplung / for vehicles with double disc clutch	(6) (4) (77)
	06.08 -		 3496 006 000		Getr. / GBox: ZF 26S,30S,35S Abgasnorm: Euro4/Euro5 / Exhaust Emission Norm: Euro4/Euro5 Abgasnorm: Euro 6 / Exhaust Emission Norm: Euro 6 langer Bügel / long handle	(6) (4) (86)
	06.08 -		 1863 869 038		Getr. / GBox: ZF 26S,30S,35S Abgasnorm: Euro4/Euro5 / Exhaust Emission Norm: Euro4/Euro5 Abgasnorm: Euro 6 / Exhaust Emission Norm: Euro 6	(6) (4)















































		CODE				
--	--	------	--	---	---	---

MAN

TGS		08.07 -				
26.320 FVHLC 42S	10.07 -	D2066LF39	 3400 700 380  3482 000 361  1878 080 037  3151 000 034	430 10 MFZ430 430WGTZ KZISZ-5	Getr. / GBox: ZF Ecosplit-3 37S,41S,42S,92S	
			 3400 700 381  3482 000 361  1878 080 037  3151 000 493	430 10 MFZ430 430WGTZ KZISZ-5	Getr. / GBox: ZF AS-Tronic 37S,41S,42S,92S für Ausrückgabel mit Rollen / for release fork with rollers	(70)
			 3400 700 403  3482 000 361  1878 004 832  3151 000 144	430 10 MFZ430 430WGTZ KZISZ-5	Getr. / GBox: ZF AS-Tronic 37S,41S,42S,92S für Ausrückgabel mit Nocken / for release fork with cams	(69)
			 3400 700 327  3482 114 031  1878 004 832  3151 263 031	430 10 GMFZ430N 430WGTZ KZIZ-6	Getr. / GBox: ZF Ecosplit-3 37S,41S,42S,92S für Fahrzeuge mit Nebenantrieb / for vehicles with PTO	(73)
			 3488 017 447	400 MFZ2/400X	Getr. / GBox: ZF Ecosplit-3 37S,41S,42S,92S für Fahrzeuge mit Zweischeibenkupplung / for vehicles with double disc clutch	(77)
			 1878 002 643	400 10 400WGTZ	Getr. / GBox: ZF Ecosplit-3 37S,41S,42S,92S für Fahrzeuge mit Zweischeibenkupplung / for vehicles with double disc clutch	(77)
			 3151 262 031	KZISZ-5	Getr. / GBox: ZF Ecosplit-3 37S,41S,42S,92S für Fahrzeuge mit Zweischeibenkupplung / for vehicles with double disc clutch	(77)
			 3496 006 000		Getr. / GBox: ZF 37S,41S,42S,92S langer Bügel / long handle	(86)
			 1863 869 038		Getr. / GBox: ZF 37S,41S,42S,92S	
26.360 FNLLW 21S	04.08 -	D2066LF37, D2066LF42, D2066LF26, D2066LF38	 3400 700 380  3482 000 361  1878 080 037  3151 000 034	430 10 MFZ430 430WGTZ KZISZ-5	Getr. / GBox: ZF Ecosplit-3	
26.360 FPHLS 42S	05.08 -		 3400 700 381  3482 000 361  1878 080 037  3151 000 493	430 10 MFZ430 430WGTZ KZISZ-5	Getr. / GBox: ZF AS-Tronic für Ausrückgabel mit Rollen / for release fork with rollers	(70)
26.360 FVHLC 24S	10.07 -		 3400 700 403  3482 000 361  1878 004 832  3151 000 144	430 10 MFZ430 430WGTZ KZISZ-5	Getr. / GBox: ZF AS-Tronic für Ausrückgabel mit Nocken / for release fork with cams	(69)
26.360 FVHLS 42S	05.08 -		 3400 700 327  3482 114 031  1878 004 832  3151 263 031	430 10 GMFZ430N 430WGTZ KZIZ-6	Getr. / GBox: ZF Ecosplit-3 für Fahrzeuge mit Nebenantrieb / for vehicles with PTO	(73)
26.400 FVHLC 24S	10.07 -		 3488 017 447	400 MFZ2/400X	Getr. / GBox: ZF Ecosplit-3 für Fahrzeuge mit Zweischeibenkupplung / for vehicles with double disc clutch	(77)
35.400 FFNHLC 73S	10.07 -		 1878 002 643	400 10 400WGTZ	Getr. / GBox: ZF Ecosplit-3 für Fahrzeuge mit Zweischeibenkupplung / for vehicles with double disc clutch	(77)
			 3151 262 031	KZISZ-5	Getr. / GBox: ZF Ecosplit-3 für Fahrzeuge mit Zweischeibenkupplung / for vehicles with double disc clutch	(77)
			 3496 006 000		Getr. / GBox: ZF langer Bügel / long handle	(86)
			 1863 869 038		Getr. / GBox: ZF	



















































		CODE				
--	--	------	--	---	---	---

MAN

TGS		08.07 -							
26.400 FPHLS 42S 26.400 FVHLS 42S	05.08 -	D2066LF37	 3400 700 380  3482 000 361  1878 080 037  3151 000 034	430 10 MFZ430 430WGTZ KZISZ-5	Getr. / GBox: ZF Ecosplit-3 21S,42S,45S				
	05.08 -		 3400 700 381  3482 000 361  1878 080 037  3151 000 493	430 10 MFZ430 430WGTZ KZISZ-5	Getr. / GBox: ZF AS-Tronic 21S,42S,45S für Ausrückgabel mit Rollen / for release fork with rollers	(70)			
			 3400 700 403  3482 000 361  1878 004 832  3151 000 144	430 10 MFZ430 430WGTZ KZISZ-5	Getr. / GBox: ZF AS-Tronic 21S,42S,45S für Ausrückgabel mit Nocken / for release fork with cams	(69)			
			 3400 700 327  3482 114 031  1878 004 832  3151 263 031	430 10 GMFZ430N 430WGTZ KZISZ-6	Getr. / GBox: ZF Ecosplit-3 21S,42S,45S für Fahrzeuge mit Nebenantrieb / for vehicles with PTO für Nebenantrieb / for PTO	(73) (82)			
			 3488 017 447	400 MFZ2/400X	Getr. / GBox: ZF Ecosplit-3 21S,42S,45S für Fahrzeuge mit Zweischeibenkupplung / for vehicles with double disc clutch enthält eine Kupplungsscheibe / This part number includes one clutch disc	(77) (66)			
			 1878 002 643	400 10 400WGTZ	Getr. / GBox: ZF Ecosplit-3 21S,42S,45S für Fahrzeuge mit Zweischeibenkupplung / for vehicles with double disc clutch	(77)			
			 3151 262 031	KZISZ-5	Getr. / GBox: ZF Ecosplit-3 21S,42S,45S für Fahrzeuge mit Zweischeibenkupplung / for vehicles with double disc clutch	(77)			
			 3496 006 000		Getr. / GBox: ZF 21S,42S,45S langer Bügel / long handle	(86)			
			 1863 869 038		Getr. / GBox: ZF 21S,42S,45S				
26.440 FDAC, FDALC, FDHLC, FDHLC/M 56S 82S 70S 26.440 FDAK, FDALK, FDHK, FDHLK 70S 82S 56S 47S 26.440 FDAS, FDALS, FDHLS, FDHLS/M 70S 82S 47S 56S 33.440 FDAC, FDALC 82S 56S 33.440 FDAK, FDALK, FDHK 82S 47S 56S 33.440 FDAS, FDALS, FDHS 56S 47S 82S	02.09 -	D2066LF25, D2066LF36, D2066LF40	 3400 700 402  3482 000 246  1878 002 139  3151 000 034	430 10 MFZ430 430WGTZ KZISZ-5	Getr. / GBox: ZF Ecosplit 3 56S,70S,82S				
	02.09 -		 3400 700 460 HD  3482 000 246  1878 004 104  3151 000 034	430 10 MFZ430 430WGTZ KZISZ-5	Getr. / GBox: ZF Ecosplit 3 56S,70S,82S				
			07.08 -	 3400 700 381  3482 000 361  1878 080 037  3151 000 493	430 10 MFZ430 430WGTZ KZISZ-5	Getr. / GBox: ZF AS-Tronic 56S,70S,82S für Ausrückgabel mit Rollen / for release fork with rollers	(70)		
				11.07 -	 3400 700 403  3482 000 361  1878 004 832  3151 000 144	430 10 MFZ430 430WGTZ KZISZ-5	Getr. / GBox: ZF AS-Tronic 56S,70S,82S für Ausrückgabel mit Nocken / for release fork with cams	(69)	
					10.07 -	 3400 700 327  3482 114 031  1878 004 832  3151 263 031	430 10 GMFZ430N 430WGTZ KZISZ-6	Getr. / GBox: ZF Ecosplit 3 56S,70S,82S für Fahrzeuge mit Nebenantrieb / for vehicles with PTO für Nebenantrieb / for PTO	(73) (82)
						 3488 017 447	400 MFZ2/400X	Getr. / GBox: ZF Ecosplit 3 56S,70S,82S für Fahrzeuge mit Zweischeibenkupplung / for vehicles with double disc clutch enthält eine Kupplungsscheibe / This part number includes one clutch disc	(77) (66)
						 1878 002 643	400 10 400WGTZ	Getr. / GBox: ZF Ecosplit 3 56S,70S,82S für Fahrzeuge mit Zweischeibenkupplung / for vehicles with double disc clutch	(77)
						 3151 262 031	KZISZ-5	Getr. / GBox: ZF Ecosplit 3 56S,70S,82S für Fahrzeuge mit Zweischeibenkupplung / for vehicles with double disc clutch	(77)
						 3496 006 000		56S,70S,82S langer Bügel / long handle	(86)
						 1863 869 038		56S,70S,82S	



















		CODE				
--	--	------	--	---	---	---

MAN

TGS		08.07 -					
26.440 FDC, FDRC, FDC/M, FDLC, FDLC/M, FDLRC, FNHLC 26S 35S 30S 26.440 FDK, FDLK 26S 30S 26.440 FDS, FDRS, FDS/M, FDLS, FDLRS, FNHLS 30S 26S 35S 26.440 FD-TM 26S 33.440 FDC, FDLC 26S 30S 33.440 FDK, FDLK 26S 30S 33.440 FDS, FDLS, FDLS/M 30S 26S	02.09 -	D2066LF36, D2066LF40	 3400 700 402  3482 000 246  1878 002 139  3151 000 034	430 10 MFZ430 430WGTZ KZISZ-5	Getr. / GBox: ZF Ecosplit 3 26S,30S,35S		
	07.08 -		 3400 700 460 HD  3482 000 246  1878 004 104  3151 000 034	430 10 MFZ430 430WGTZ KZISZ-5	Getr. / GBox: ZF Ecosplit 3 26S,30S,35S		
	02.09 -		 3400 700 381  3482 000 361  1878 080 037  3151 000 493	430 10 MFZ430 430WGTZ KZISZ-5	Getr. / GBox: ZF AS-Tronic 26S,30S,35S für Ausrückgabel mit Rollen / for release fork with rollers	(70)	
	07.08 -		 3400 700 403  3482 000 361  1878 004 832  3151 000 144	430 10 MFZ430 430WGTZ KZISZ-5	Getr. / GBox: ZF AS-Tronic 26S,30S,35S für Ausrückgabel mit Nocken / for release fork with cams	(69)	
	06.08 -		 3400 700 327  3482 114 031  1878 004 832  3151 263 031	430 10 GMFZ430N 430WGTZ KZISZ-6	Getr. / GBox: ZF Ecosplit 3 26S,30S,35S für Fahrzeuge mit Nebenantrieb / for vehicles with PTO für Nebenantrieb / for PTO	(73) (82)	
	06.08 -		 3488 017 447	400 MFZ2/400X	Getr. / GBox: ZF Ecosplit 3 26S,30S,35S für Fahrzeuge mit Zweischeibenkupplung / for vehicles with double disc clutch enthält eine Kupplungsscheibe / This part number includes one clutch disc	(77) (66)	
	06.08 -		 1878 002 643	400 10 400WGTZ	Getr. / GBox: ZF Ecosplit 3 26S,30S,35S für Fahrzeuge mit Zweischeibenkupplung / for vehicles with double disc clutch	(77)	
	06.08 -		 3151 262 031	KZISZ-5	Getr. / GBox: ZF Ecosplit 3 26S,30S,35S für Fahrzeuge mit Zweischeibenkupplung / for vehicles with double disc clutch	(77)	
			 3496 006 000		26S,30S,35S langer Bügel / long handle	(86)	
			 1863 869 038		26S,30S,35S		
26.440 FPHLS 42S 26.440 FVHLC 42S 26.440 FVHLS 42S 32.440 FFD-TM, FFDR-TM 49S	05.08 -	D2066LF25, D2066LF36, D2066LF40	 3400 700 402  3482 000 246  1878 002 139  3151 000 034	430 10 MFZ430 430WGTZ KZISZ-5	Getr. / GBox: ZF Ecosplit 3 42S,49S		
	10.07 -		 3400 700 460 HD  3482 000 246  1878 004 104  3151 000 034	430 10 MFZ430 430WGTZ KZISZ-5	Getr. / GBox: ZF Ecosplit 3 42S,49S		
	05.08 -		 3400 700 381  3482 000 361  1878 080 037  3151 000 493	430 10 MFZ430 430WGTZ KZISZ-5	Getr. / GBox: ZF AS-Tronic 42S,49S für Ausrückgabel mit Rollen / for release fork with rollers	(70)	
	10.07 -		 3400 700 403  3482 000 361  1878 004 832  3151 000 144	430 10 MFZ430 430WGTZ KZISZ-5	Getr. / GBox: ZF AS-Tronic 42S,49S für Ausrückgabel mit Nocken / for release fork with cams	(69)	
			 3400 700 327  3482 114 031  1878 004 832  3151 263 031	430 10 GMFZ430N 430WGTZ KZISZ-6	Getr. / GBox: ZF Ecosplit 3 42S,49S für Fahrzeuge mit Nebenantrieb / for vehicles with PTO für Nebenantrieb / for PTO	(73) (82)	
			 3488 017 447	400 MFZ2/400X	Getr. / GBox: ZF Ecosplit 3 42S,49S für Fahrzeuge mit Zweischeibenkupplung / for vehicles with double disc clutch enthält eine Kupplungsscheibe / This part number includes one clutch disc	(77) (66)	
			 1878 002 643	400 10 400WGTZ	Getr. / GBox: ZF Ecosplit 3 42S,49S für Fahrzeuge mit Zweischeibenkupplung / for vehicles with double disc clutch	(77)	
			 3151 262 031	KZISZ-5	Getr. / GBox: ZF Ecosplit 3 42S,49S für Fahrzeuge mit Zweischeibenkupplung / for vehicles with double disc clutch	(77)	
			 3496 006 000		42S,49S langer Bügel / long handle	(86)	
			 1863 869 038		42S,49S		



















		CODE				
--	--	------	--	---	---	---

MAN

TGS		08.07 -				
26.480 FDAC, FDALC, FDHLC, FDHLC/M 56S 70S 82S 26.480 FDAK, FDALK, FDHK, FDHLK 70S 82S 56S 26.480 FDAS, FDALS, FDHS, FDHLS 82S 70S 47S 56S 33.480 FDAC, FDALC 56S 82S 33.480 FDAK, FDALK 47S 56S 82S 33.480 FDAS, FDALS, FDHS 82S 56S 47S	02.09-	D2676LF07, D2676LF14, D2676LF05	 3400 700 460 HD  3482 000 246  1878 004 104  3151 000 034	430 10 MFZ430 430WGTZ KZISZ-5	Getr. / GBox: ZF Ecosplit 3 56S,70S,82S Abgasnorm: Euro5/Euro6 / Exhaust Emission Norm: Euro5/Euro6	(7)
	02.09-		 3400 700 459 HD  3482 000 246  1878 004 104  3151 000 493	430 10 MFZ430 430WGTZ KZISZ-5	Getr. / GBox: ZF AS-Tronic 56S,70S,82S Abgasnorm: Euro5/Euro6 / Exhaust Emission Norm: Euro5/Euro6 für Ausrückgabel mit Rollen / for release fork with rollers	(7) (70)
	02.09-		 3151 000 144	KZISZ-5	Getr. / GBox: ZF AS-Tronic 56S,70S,82S Abgasnorm: Euro5/Euro6 / Exhaust Emission Norm: Euro5/Euro6 für Ausrückgabel mit Nocken / for release fork with cams	(7) (69)
	08.08-		 3400 700 327  3482 114 031  1878 004 832  3151 263 031	430 10 GMFZ430N 430WGTZ KZIZ-6	Getr. / GBox: ZF Ecosplit 3 56S,70S,82S Abgasnorm: Euro5/Euro6 / Exhaust Emission Norm: Euro5/Euro6 für Fahrzeuge mit Nebenantrieb / for vehicles with PTO für Nebenantrieb / for PTO	(7) (73) (82)
	08.08-		 3488 017 447	400 MFZ2/400X	Getr. / GBox: ZF Ecosplit 3 56S,70S,82S Abgasnorm: Euro5/Euro6 / Exhaust Emission Norm: Euro5/Euro6 für Fahrzeuge mit Zweischeibenkupplung / for vehicles with double disc clutch enthält eine Kupplungsscheibe / This part number includes one clutch disc	(7) (77) (66)
	10.07-		 1878 002 643	400 10 400WGTZ	Getr. / GBox: ZF Ecosplit 3 56S,70S,82S Abgasnorm: Euro5/Euro6 / Exhaust Emission Norm: Euro5/Euro6 für Fahrzeuge mit Zweischeibenkupplung / for vehicles with double disc clutch	(7) (77)
			 3151 262 031	KZISZ-5	Getr. / GBox: ZF Ecosplit 3 56S,70S,82S Abgasnorm: Euro5/Euro6 / Exhaust Emission Norm: Euro5/Euro6 für Fahrzeuge mit Zweischeibenkupplung / for vehicles with double disc clutch	(7) (77)
			 3496 006 000		56S,70S,82S Abgasnorm: Euro5/Euro6 / Exhaust Emission Norm: Euro5/Euro6 langer Bügel / long handle	(7) (86)
			 1863 869 038		56S,70S,82S Abgasnorm: Euro5/Euro6 / Exhaust Emission Norm: Euro5/Euro6	(7)











































		CODE				
--	--	------	--	---	---	---

MAN

TGS		08.07 -					
26.480 FDC, FDC/M, FDLC, FDLC/M, FDRC, FDRC/M, FDLRC, FNLHC 35S 30S 26S 26.480 FDK, FDLK 30S 26S 26.480 FDS, FDS/M, FDLS, FDLS/M, FDRS, FDLRS, FDRS/M, FNHLS 26S 35S 30S 33.480 FDC, FDC/M, FDLC, FDLC/M 26S 30S 33.480 FDK, FDLK 26S 30S 33.480 FDS, FDLS, FDLS/M 26S 30S	02.09-	D2676LF07, D2676LF05	 3400 700 460 HD  3482 000 246  1878 004 104  3151 000 034	430 10 MFZ430 430WGTZ KZISZ-5	Getr. / GBox: ZF Ecosplit 3 26S,30S,35S Abgasnorm: Euro4/Euro5 / Exhaust Emission Norm: Euro4/Euro5 Abgasnorm: Euro 6 / Exhaust Emission Norm: Euro 6	(6) (4)	
	07.08-		 3400 700 459 HD  3482 000 246  1878 004 104  3151 000 493	430 10 MFZ430 430WGTZ KZISZ-5	Getr. / GBox: ZF AS-Tronic 26S,30S,35S Abgasnorm: Euro4/Euro5 / Exhaust Emission Norm: Euro4/Euro5 Abgasnorm: Euro 6 / Exhaust Emission Norm: Euro 6 für Ausrückgabel mit Rollen / for release fork with rollers	(6) (4) (70)	
	02.09-						
	08.08-			 3151 000 144	KZISZ-5	Getr. / GBox: ZF AS-Tronic 26S,30S,35S Abgasnorm: Euro4/Euro5 / Exhaust Emission Norm: Euro4/Euro5 Abgasnorm: Euro 6 / Exhaust Emission Norm: Euro 6 für Ausrückgabel mit Nocken / for release fork with cams	(6) (4) (69)
	08.08-						
	08.08-			 3400 700 327  3482 114 031  1878 004 832  3151 263 031	430 10 GMFZ430N 430WGTZ KZIZ-6	Getr. / GBox: ZF Ecosplit 3 26S,30S,35S Abgasnorm: Euro4/Euro5 / Exhaust Emission Norm: Euro4/Euro5 Abgasnorm: Euro 6 / Exhaust Emission Norm: Euro 6 für Fahrzeuge mit Nebenantrieb / for vehicles with PTO für Nebenantrieb / for PTO	(6) (4) (73) (82)
				 3488 017 447	400 MFZ2/400X	Getr. / GBox: ZF Ecosplit 3 26S,30S,35S Abgasnorm: Euro4/Euro5 / Exhaust Emission Norm: Euro4/Euro5 Abgasnorm: Euro 6 / Exhaust Emission Norm: Euro 6 für Fahrzeuge mit Zweischeibenkupplung / for vehicles with double disc clutch enthält eine Kupplungsscheibe / This part number includes one clutch disc	(6) (4) (77) (66)
				 1878 002 643	400 10 400WGTZ	Getr. / GBox: ZF Ecosplit 3 26S,30S,35S Abgasnorm: Euro4/Euro5 / Exhaust Emission Norm: Euro4/Euro5 Abgasnorm: Euro 6 / Exhaust Emission Norm: Euro 6 für Fahrzeuge mit Zweischeibenkupplung / for vehicles with double disc clutch	(6) (4) (77)
				 3151 262 031	KZISZ-5	Getr. / GBox: ZF Ecosplit 3 26S,30S,35S Abgasnorm: Euro4/Euro5 / Exhaust Emission Norm: Euro4/Euro5 Abgasnorm: Euro 6 / Exhaust Emission Norm: Euro 6 für Fahrzeuge mit Zweischeibenkupplung / for vehicles with double disc clutch	(6) (4) (77)
			 3496 006 000		26S,30S,35S Abgasnorm: Euro4/Euro5 / Exhaust Emission Norm: Euro4/Euro5 Abgasnorm: Euro 6 / Exhaust Emission Norm: Euro 6 langer Bügel / long handle	(6) (4) (86)	
			 1863 869 038		26S,30S,35S Abgasnorm: Euro4/Euro5 / Exhaust Emission Norm: Euro4/Euro5 Abgasnorm: Euro 6 / Exhaust Emission Norm: Euro 6	(6) (4)	





































		CODE				
--	--	------	--	---	---	---

MAN

TGS		08.07 -				
26.480 FNLC, FNLCR, FNLLC, FNLLRC, FNLLW, FVLC, FVLCO 18S 24S 21S 26.480 FNLS, FNLLS, FNLRs, FPLS, FPLRS, FVLS 21S 24S 18S	10.07 -	D2676LF07, D2676LF14, D2676LF05	 3400 700 402  3482 000 246  1878 002 139  3151 000 034	430 10 MFZ430 430WGTZ KZISZ-5	Getr. / GBox: ZF Ecosplit-3 03S,06S,08S,13S / 10S,18S,22S,24S Abgasnorm: Euro4/Euro5 / Exhaust Emission Norm: Euro4/Euro5 Abgasnorm: Euro 6 / Exhaust Emission Norm: Euro 6	(6) (4)
	02.09 -		 3400 700 460 HD  3482 000 246  1878 004 104  3151 000 034	430 10 MFZ430 430WGTZ KZISZ-5	Getr. / GBox: ZF Ecosplit-3 03S,06S,08S,13S / 10S,18S,22S,24S	
			 3400 700 459 HD  3482 000 246  1878 004 104  3151 000 493	430 10 MFZ430 430WGTZ KZISZ-5	Getr. / GBox: ZF AS-Tronic 03S,06S,08S,13S / 10S,18S,22S,24S für Ausrückgabel mit Rollen / for release fork with rollers	(70)
			 3400 700 404  3482 000 246  1878 002 139  3151 000 144	430 10 MFZ430 430WGTZ KZISZ-5	Getr. / GBox: ZF AS-Tronic 03S,06S,08S,13S / 10S,18S,22S,24S für Ausrückgabel mit Nocken / for release fork with cams	(69)
			 3400 700 327  3482 114 031  1878 004 832  3151 263 031	430 10 GMFZ430N 430WGTZ KZISZ-6	Getr. / GBox: ZF Ecosplit-3 03S,06S,08S,13S / 10S,18S,22S,24S für Fahrzeuge mit Nebenantrieb / for vehicles with PTO für Nebenantrieb / for PTO	(73) (82)
			 3488 017 447	400 MFZ2/400X	Getr. / GBox: ZF Ecosplit-3 03S,06S,08S,13S / 10S,18S,22S,24S für Fahrzeuge mit Zweischeibenkupplung / for vehicles with double disc clutch enthält eine Kupplungsscheibe / This part number includes one clutch disc	(77) (66)
			 1878 002 643	400 10 400WGTZ	Getr. / GBox: ZF Ecosplit-3 03S,06S,08S,13S / 10S,18S,22S,24S für Fahrzeuge mit Zweischeibenkupplung / for vehicles with double disc clutch	(77)
			 3151 262 031	KZISZ-5	Getr. / GBox: ZF Ecosplit-3 03S,06S,08S,13S / 10S,18S,22S,24S für Fahrzeuge mit Zweischeibenkupplung / for vehicles with double disc clutch	(77)
			 3496 006 000		Getr. / GBox: ZF 03S,06S,08S,13S / 10S,18S,22S,24S langer Bügel / long handle	(86)
			 1863 869 038		Getr. / GBox: ZF 03S,06S,08S,13S / 10S,18S,22S,24S	
26.480 FPHLS 42S 26.480 FVHLC 42S 26.480 FVHLS 42S 28.540 FNHLC 71S 28.540 FNLC 89S 74S 28.540 FNLS 89S	05.08 -	D2676LF06, D2676LF05	 3400 700 460 HD  3482 000 246  1878 004 104  3151 000 034	430 10 MFZ430 430WGTZ KZISZ-5	Getr. / GBox: ZF Ecosplit 3 42S,71S,74S,84S,89S	
	10.07 -		 3400 700 459 HD  3482 000 246  1878 004 104  3151 000 493	430 10 MFZ430 430WGTZ KZISZ-5	Getr. / GBox: ZF AS-Tronic 42S,71S,74S,84S,89S für Ausrückgabel mit Rollen / for release fork with rollers	(70)
	05.08 -		 3151 000 144	KZISZ-5	Getr. / GBox: ZF AS-Tronic 42S,71S,74S,84S,89S für Ausrückgabel mit Nocken / for release fork with cams	(69)
	06.08 -		 3400 700 327  3482 114 031  1878 004 832  3151 263 031	430 10 GMFZ430N 430WGTZ KZISZ-6	Getr. / GBox: ZF Ecosplit 3 42S,71S,74S,84S,89S für Fahrzeuge mit Nebenantrieb / for vehicles with PTO für Nebenantrieb / for PTO	(73) (82)
	02.09 -		 3488 017 447	400 MFZ2/400X	Getr. / GBox: ZF Ecosplit 3 42S,71S,74S,84S,89S für Fahrzeuge mit Zweischeibenkupplung / for vehicles with double disc clutch enthält eine Kupplungsscheibe / This part number includes one clutch disc	(77) (66)
	02.09 -		 1878 002 643	400 10 400WGTZ	Getr. / GBox: ZF Ecosplit 3 42S,71S,74S,84S,89S für Fahrzeuge mit Zweischeibenkupplung / for vehicles with double disc clutch	(77)
			 3151 262 031	KZISZ-5	Getr. / GBox: ZF Ecosplit 3 42S,71S,74S,84S,89S für Fahrzeuge mit Zweischeibenkupplung / for vehicles with double disc clutch	(77)
			 3496 006 000		42S,71S,74S,84S,89S langer Bügel / long handle	(86)
			 1863 869 038		42S,71S,74S,84S,89S	





















		CODE				
--	--	------	--	---	---	---

MAN

TGS		08.07 -				
26.540 FDAC, FDALC, FDHLC, FDHLC/M 82S 56S 70S 26.540 FDAK, FDALK, FDHLK 82S 56S 70S 26.540 FDAS, FDALS, FDHLS 70S 56S 82S 33.540 FDAC, FDALC 82S 56S 33.540 FDAK, FDALK 82S 56S 33.540 FDAS, FDALS 56S 82S	02.09-	D2676LF13, D2676LF06	 3400 700 460 HD  3482 000 246  1878 004 104  3151 000 034	430 10 MFZ430 430WGTZ KZISZ-5	Getr. / GBox: ZF Ecosplit 3 56S,70S,82S	
	11.07-		 3400 700 459 HD  3482 000 246  1878 004 104  3151 000 493	430 10 MFZ430 430WGTZ KZISZ-5	Getr. / GBox: ZF AS-Tronic 56S,70S,82S für Ausrückgabel mit Rollen / for release fork with rollers	(70)
	02.09-		 3151 000 144	KZISZ-5	Getr. / GBox: ZF AS-Tronic 56S,70S,82S für Ausrückgabel mit Nocken / for release fork with cams	(69)
	02.09-		 3400 700 327  3482 114 031  1878 004 832  3151 263 031	430 10 GMFZ430N 430WGTZ KZISZ-6	Getr. / GBox: ZF Ecosplit 3 56S,70S,82S für Fahrzeuge mit Nebenantrieb / for vehicles with PTO für Nebenantrieb / for PTO	(73) (82)
	02.09-		 3488 017 447	400 MFZ2/400X	Getr. / GBox: ZF Ecosplit 3 56S,70S,82S für Fahrzeuge mit Zweischeibenkupplung / for vehicles with double disc clutch enthält eine Kupplungsscheibe / This part number includes one clutch disc	(77) (66)
	02.09-		 1878 002 643	400 10 400WGTZ	Getr. / GBox: ZF Ecosplit 3 56S,70S,82S für Fahrzeuge mit Zweischeibenkupplung / for vehicles with double disc clutch	(77)
	02.09-		 3151 262 031	KZISZ-5	Getr. / GBox: ZF Ecosplit 3 56S,70S,82S für Fahrzeuge mit Zweischeibenkupplung / for vehicles with double disc clutch	(77)
	02.09-		 3496 006 000		56S,70S,82S langer Bügel / long handle	(86)
	02.09-		 1863 869 038		56S,70S,82S	
	26.540 FDC, FDC/M, FDLC, FDLC/M, FDLRC, FDLRC/M, FNHLC 30S 35S 26S 26.540 FDK, FDLK 26S 30S 26.540 FDS, FDS/M, FDLS, FDRS, FDLRS, FDLS/M, FNHLS 35S 30S 26S 33.540 FDC, FDLC, FDLC/M 26S 30S 33.540 FDK, FDLK 26S 30S 33.540 FDS, FDLS, FDLS/M 30S 26S		02.09-	D2676LF06	 3400 700 460 HD  3482 000 246  1878 004 104  3151 000 034	430 10 MFZ430 430WGTZ KZISZ-5
02.09-		 3400 700 459 HD  3482 000 246  1878 004 104  3151 000 493	430 10 MFZ430 430WGTZ KZISZ-5		Getr. / GBox: ZF AS-Tronic 26S,30S,35S für Ausrückgabel mit Rollen / for release fork with rollers	(70)
02.09-		 3151 000 144	KZISZ-5		Getr. / GBox: ZF AS-Tronic 26S,30S,35S für Ausrückgabel mit Nocken / for release fork with cams	(69)
02.09-		 3400 700 327  3482 114 031  1878 004 832  3151 263 031	430 10 GMFZ430N 430WGTZ KZISZ-6		Getr. / GBox: ZF Ecosplit 3 26S,30S,35S für Fahrzeuge mit Nebenantrieb / for vehicles with PTO für Nebenantrieb / for PTO	(73) (82)
02.09-		 3488 017 447	400 MFZ2/400X		Getr. / GBox: ZF Ecosplit 3 26S,30S,35S für Fahrzeuge mit Zweischeibenkupplung / for vehicles with double disc clutch enthält eine Kupplungsscheibe / This part number includes one clutch disc	(77) (66)
02.09-		 1878 002 643	400 10 400WGTZ		Getr. / GBox: ZF Ecosplit 3 26S,30S,35S für Fahrzeuge mit Zweischeibenkupplung / for vehicles with double disc clutch	(77)
02.09-		 3151 262 031	KZISZ-5		Getr. / GBox: ZF Ecosplit 3 26S,30S,35S für Fahrzeuge mit Zweischeibenkupplung / for vehicles with double disc clutch	(77)
02.09-		 3496 006 000			26S,30S,35S langer Bügel / long handle	(86)
02.09-		 1863 869 038			26S,30S,35S	



















		CODE				
--	--	------	--	---	---	---

MAN

TGS		08.07 -			
28.320 FNHLC 71S	07.08-	D2066LF43, D2066LF42, D2066LF37, D2066LF39, D2066LF41, D2066LF38	 3400 700 380  3482 000 361  1878 080 037  3151 000 034	430 10 MFZ430 430WGTZ KZISZ-5	Getr. / GBox: ZF Ecosplit-3 71S,74S,84S,89S Abgasnorm: Euro5/Euro6 / Exhaust Emission Norm: Euro5/Euro6 (7)
28.320 FNLC 74S 89S	07.08-		 3400 700 381  3482 000 361  1878 080 037  3151 000 493	430 10 MFZ430 430WGTZ KZISZ-5	Getr. / GBox: ZF AS-Tronic 71S,74S,84S,89S Abgasnorm: Euro5/Euro6 / Exhaust Emission Norm: Euro5/Euro6 (7)
28.320 FNLS 89S	07.08-				für Ausrückgabel mit Rollen / for release fork with rollers (70)
28.360 FANLK 84S	08.08-		 3400 700 403  3482 000 361  1878 004 832  3151 000 144	430 10 MFZ430 430WGTZ KZISZ-5	Getr. / GBox: ZF AS-Tronic 71S,74S,84S,89S Abgasnorm: Euro5/Euro6 / Exhaust Emission Norm: Euro5/Euro6 (7)
28.360 FNLC 89S 74S	08.08-				für Ausrückgabel mit Nocken / for release fork with cams (69)
28.360 FNLS 89S	08.08-				
28.400 FANLC, FNHLC 71S 84S	08.08-		 3400 700 327  3482 114 031  1878 004 832  3151 263 031	430 10 GMFZ430N 430WGTZ KZIZ-6	Getr. / GBox: ZF Ecosplit-3 71S,74S,84S,89S Abgasnorm: Euro5/Euro6 / Exhaust Emission Norm: Euro5/Euro6 (7)
28.400 FANLK 84S	08.08-				für Fahrzeuge mit Nebenantrieb / for vehicles with PTO (73)
28.400 FNLC 89S 74S	08.08-				für Nebenantrieb / for PTO (82)
28.400 FNLS 89S	08.08-		 3488 017 447	400 MFZ2/400X	Getr. / GBox: ZF Ecosplit-3 71S,74S,84S,89S Abgasnorm: Euro5/Euro6 / Exhaust Emission Norm: Euro5/Euro6 (7)
					für Fahrzeuge mit Zweischeibenkupplung / for vehicles with double disc clutch (77)
					enthält eine Kupplungsscheibe / This part number includes one clutch disc (66)
			 1878 002 643	400 10 400WGTZ	Getr. / GBox: ZF Ecosplit-3 71S,74S,84S,89S Abgasnorm: Euro5/Euro6 / Exhaust Emission Norm: Euro5/Euro6 (7)
					für Fahrzeuge mit Zweischeibenkupplung / for vehicles with double disc clutch (77)
			 3151 262 031	KZISZ-5	Getr. / GBox: ZF Ecosplit-3 71S,74S,84S,89S Abgasnorm: Euro5/Euro6 / Exhaust Emission Norm: Euro5/Euro6 (7)
					für Fahrzeuge mit Zweischeibenkupplung / for vehicles with double disc clutch (77)
			 3496 006 000		Getr. / GBox: ZF 71S,74S,84S,89S Abgasnorm: Euro5/Euro6 / Exhaust Emission Norm: Euro5/Euro6 (7)
					langer Bügel / long handle (86)
			 1863 869 038		Getr. / GBox: ZF 71S,74S,84S,89S Abgasnorm: Euro5/Euro6 / Exhaust Emission Norm: Euro5/Euro6 (7)



















		CODE				
--	--	------	--	---	---	---

MAN

TGS		08.07 -				
28.360 FANLC, FNHLC 84S 71S	08.08 -	D2066LF42, D2066LF38	 3400 700 380 ⊕ 3482 000 361 ⊕ 1878 080 037 ⊕ 3151 000 034	430 10 MFZ430 430WGTZ KZISZ-5	Getr. / GBox: ZF Ecosplit-3 71S,74S,84S,89S	
			 3400 700 381 ⊕ 3482 000 361 ⊕ 1878 080 037 ⊕ 3151 000 493	430 10 MFZ430 430WGTZ KZISZ-5	Getr. / GBox: ZF AS-Tronic 71S,74S,84S,89S für Ausrückgabel mit Rollen / for release fork with rollers	(70)
			 3400 700 403 ⊕ 3482 000 361 ⊕ 1878 004 832 ⊕ 3151 000 144	430 10 MFZ430 430WGTZ KZISZ-5	Getr. / GBox: ZF AS-Tronic 71S,74S,84S,89S für Ausrückgabel mit Nocken / for release fork with cams	(69)
			 3400 700 327 ⊕ 3482 114 031 ⊕ 1878 004 832 ⊕ 3151 263 031	430 10 GMFZ430N 430WGTZ KZIZ-6	Getr. / GBox: ZF Ecosplit-3 71S,74S,84S,89S für Fahrzeuge mit Nebenantrieb / for vehicles with PTO	(73)
			 3488 017 447	400 MFZ2/400X	Getr. / GBox: ZF Ecosplit-3 71S,74S,84S,89S für Fahrzeuge mit Zweischeibenkupplung / for vehicles with double disc clutch	(77)
			 1878 002 643	400 10 400WGTZ	Getr. / GBox: ZF Ecosplit-3 71S,74S,84S,89S für Fahrzeuge mit Zweischeibenkupplung / for vehicles with double disc clutch	(66)
			 3151 262 031	KZISZ-5	Getr. / GBox: ZF Ecosplit-3 71S,74S,84S,89S für Fahrzeuge mit Zweischeibenkupplung / for vehicles with double disc clutch	(77)
			 3496 006 000		Getr. / GBox: ZF 71S,74S,84S,89S langer Bügel / long handle	(77)
			 1863 869 038		Getr. / GBox: ZF 71S,74S,84S,89S	(86)
28.440 FANLC, FNHLC 84S 71S 28.440 FANLK 84S 28.440 FNLC 89S 74S 28.440 FNLS 89S 32.440 FFDRC 49S	08.08 - 08.08 - 08.08 - 08.08 - 08.08 -	D2066LF36, D2066LF40	 3400 700 402 ⊕ 3482 000 246 ⊕ 1878 002 139 ⊕ 3151 000 034	430 10 MFZ430 430WGTZ KZISZ-5	Getr. / GBox: ZF Ecosplit 3 49S,71S,74S,84S,89S	
			 3400 700 460 HD ⊕ 3482 000 246 ⊕ 1878 004 104 ⊕ 3151 000 034	430 10 MFZ430 430WGTZ KZISZ-5	Getr. / GBox: ZF Ecosplit 3 49S,71S,74S,84S,89S	
			 3400 700 381 ⊕ 3482 000 361 ⊕ 1878 080 037 ⊕ 3151 000 493	430 10 MFZ430 430WGTZ KZISZ-5	Getr. / GBox: ZF AS-Tronic 49S,71S,74S,84S,89S für Ausrückgabel mit Rollen / for release fork with rollers	(70)
			 3400 700 403 ⊕ 3482 000 361 ⊕ 1878 004 832 ⊕ 3151 000 144	430 10 MFZ430 430WGTZ KZISZ-5	Getr. / GBox: ZF AS-Tronic 49S,71S,74S,84S,89S für Ausrückgabel mit Nocken / for release fork with cams	(69)
			 3400 700 327 ⊕ 3482 114 031 ⊕ 1878 004 832 ⊕ 3151 263 031	430 10 GMFZ430N 430WGTZ KZIZ-6	Getr. / GBox: ZF Ecosplit 3 49S,71S,74S,84S,89S für Fahrzeuge mit Nebenantrieb / for vehicles with PTO	(73)
			 3488 017 447	400 MFZ2/400X	Getr. / GBox: ZF Ecosplit 3 49S,71S,74S,84S,89S für Fahrzeuge mit Zweischeibenkupplung / for vehicles with double disc clutch	(82)
			 1878 002 643	400 10 400WGTZ	Getr. / GBox: ZF Ecosplit 3 49S,71S,74S,84S,89S für Fahrzeuge mit Zweischeibenkupplung / for vehicles with double disc clutch	(77)
			 3151 262 031	KZISZ-5	Getr. / GBox: ZF Ecosplit 3 49S,71S,74S,84S,89S für Fahrzeuge mit Zweischeibenkupplung / for vehicles with double disc clutch	(66)
			 3496 006 000		Getr. / GBox: ZF Ecosplit 3 49S,71S,74S,84S,89S langer Bügel / long handle	(77)
			 1863 869 038		Getr. / GBox: ZF Ecosplit 3 49S,71S,74S,84S,89S	(86)





















		CODE				
--	--	------	--	---	---	---

MAN

TGS		08.07 -				
28.480 FANLC, FNHLC 71S 84S 28.480 FANLK 84S 28.480 FNLC 74S 89S 28.480 FNLS 89S	08.08-	D2676LF07, D2676LF05	 3400 700 460 HD  3482 000 246  1878 004 104  3151 000 034	430 10 MFZ430 430WGTZ KZISZ-5	Getr. / GBox: ZF Ecosplit 3 42S,71S,74S,84S,89S Abgasnorm: Euro5/Euro6 / Exhaust Emission Norm: Euro5/Euro6	(7)
	08.08-		 3400 700 459 HD  3482 000 246  1878 004 104  3151 000 493	430 10 MFZ430 430WGTZ KZISZ-5	Getr. / GBox: ZF AS-Tronic 42S,71S,74S,84S,89S Abgasnorm: Euro5/Euro6 / Exhaust Emission Norm: Euro5/Euro6 für Ausrückgabel mit Rollen / for release fork with rollers	(7) (70)
	08.08-		 3151 000 144	KZISZ-5	Getr. / GBox: ZF AS-Tronic 42S,71S,74S,84S,89S Abgasnorm: Euro5/Euro6 / Exhaust Emission Norm: Euro5/Euro6 für Ausrückgabel mit Nocken / for release fork with cams	(7) (69)
	08.08-		 3400 700 327  3482 114 031  1878 004 832  3151 263 031	430 10 GMFZ430N 430WGTZ KZIZ-6	Getr. / GBox: ZF Ecosplit 3 42S,71S,74S,84S,89S Abgasnorm: Euro5/Euro6 / Exhaust Emission Norm: Euro5/Euro6 für Fahrzeuge mit Nebenantrieb / for vehicles with PTO für Nebenantrieb / for PTO	(7) (73) (82)
			 3488 017 447	400 MFZ2/400X	Getr. / GBox: ZF Ecosplit 3 42S,71S,74S,84S,89S Abgasnorm: Euro5/Euro6 / Exhaust Emission Norm: Euro5/Euro6 für Fahrzeuge mit Zweischeibenkupplung / for vehicles with double disc clutch enthält eine Kupplungsscheibe / This part number includes one clutch disc	(7) (77) (66)
			 1878 002 643	400 10 400WGTZ	Getr. / GBox: ZF Ecosplit 3 42S,71S,74S,84S,89S Abgasnorm: Euro5/Euro6 / Exhaust Emission Norm: Euro5/Euro6 für Fahrzeuge mit Zweischeibenkupplung / for vehicles with double disc clutch	(7) (77)
			 3151 262 031	KZISZ-5	Getr. / GBox: ZF Ecosplit 3 42S,71S,74S,84S,89S Abgasnorm: Euro5/Euro6 / Exhaust Emission Norm: Euro5/Euro6 für Fahrzeuge mit Zweischeibenkupplung / for vehicles with double disc clutch	(7) (77)
			 3496 006 000		42S,71S,74S,84S,89S Abgasnorm: Euro5/Euro6 / Exhaust Emission Norm: Euro5/Euro6 langer Bügel / long handle	(7) (86)
			 1863 869 038		42S,71S,74S,84S,89S Abgasnorm: Euro5/Euro6 / Exhaust Emission Norm: Euro5/Euro6	(7)









		CODE		 Parameter	 i	
--	--	------	--	---	---	---

MAN

TGS		08.07 -					
32.320 FFD-TM 49S 32.360 FFD-TM, FFDR-TM 49S 32.400 FFD-TM, FFDR-TM 49S 35.320 FFNLC 90S 35.360 FFNLC 90S 35.400 FFNLC 90S	02.09-	D2066LF43, D2066LF27, D2066LF42, D2066LF37, D2066LF39, D2066LF41, D2066LF26, D2066LF38		3400 700 380  3482 000 361  1878 080 037  3151 000 034	430 10 MFZ430 430WGTZ KZISZ-5	Getr. / GBox: ZF Ecosplit-3 49S,59S,93S,90S,96S Abgasnorm: Euro5/Euro6 / Exhaust Emission Norm: Euro5/Euro6	(7)
	10.07-			3400 700 381  3482 000 361  1878 080 037  3151 000 493	430 10 MFZ430 430WGTZ KZISZ-5	Getr. / GBox: ZF AS-Tronic 49S,59S,93S,90S,96S Abgasnorm: Euro5/Euro6 / Exhaust Emission Norm: Euro5/Euro6 für Ausrückgabel mit Rollen / for release fork with rollers	(7)
	10.07-			3400 700 403  3482 000 361  1878 004 832  3151 000 144	430 10 MFZ430 430WGTZ KZISZ-5	Getr. / GBox: ZF AS-Tronic 49S,59S,93S,90S,96S Abgasnorm: Euro5/Euro6 / Exhaust Emission Norm: Euro5/Euro6 für Ausrückgabel mit Nocken / for release fork with cams	(7)
	01.09-			3400 700 327  3482 114 031  1878 004 832  3151 263 031	430 10 GMFZ430N 430WGTZ KZIZ-6	Getr. / GBox: ZF Ecosplit-3 49S,59S,93S,90S,96S Abgasnorm: Euro5/Euro6 / Exhaust Emission Norm: Euro5/Euro6 für Fahrzeuge mit Nebenantrieb / for vehicles with PTO für Nebenantrieb / for PTO	(7)
	06.08-			3488 017 447	400 MFZ2/400X	Getr. / GBox: ZF Ecosplit-3 49S,59S,93S,90S,96S Abgasnorm: Euro5/Euro6 / Exhaust Emission Norm: Euro5/Euro6 für Fahrzeuge mit Zweischeibenkupplung / for vehicles with double disc clutch enthält eine Kupplungsscheibe / This part number includes one clutch disc	(7)
	06.08-			1878 002 643	400 10 400WGTZ	Getr. / GBox: ZF Ecosplit-3 49S,59S,93S,90S,96S Abgasnorm: Euro5/Euro6 / Exhaust Emission Norm: Euro5/Euro6 für Fahrzeuge mit Zweischeibenkupplung / for vehicles with double disc clutch	(7)
				3151 262 031	KZISZ-5	Getr. / GBox: ZF Ecosplit-3 49S,59S,93S,90S,96S Abgasnorm: Euro5/Euro6 / Exhaust Emission Norm: Euro5/Euro6 für Fahrzeuge mit Zweischeibenkupplung / for vehicles with double disc clutch	(7)
				3496 006 000		Getr. / GBox: ZF 49S,59S,93S,90S,96S Abgasnorm: Euro5/Euro6 / Exhaust Emission Norm: Euro5/Euro6 langer Bügel / long handle	(7)
				1863 869 038		Getr. / GBox: ZF 49S,59S,93S,90S,96S Abgasnorm: Euro5/Euro6 / Exhaust Emission Norm: Euro5/Euro6	(7)



















		CODE				
--	--	------	--	---	---	---





















MAN

TGS		08.07 -						
32.360 FFDRC 49S	08.08-	D2066LF43, D2066LF42, D2066LF37, D2066LF39, D2066LF41, D2066LF38		3400 700 380 ⊗ 3482 000 361 ⊗ 1878 080 037 ⊙ 3151 000 034	430 10 MFZ430 430WGTZ KZISZ-5	Getr. / GBox: ZF Ecosplit-3 49S,59S,93S,90S,96S		
32.400 FFDRC 49S	08.08-			3400 700 381 ⊗ 3482 000 361 ⊗ 1878 080 037 ⊙ 3151 000 493	430 10 MFZ430 430WGTZ KZISZ-5	Getr. / GBox: ZF AS-Tronic 49S,59S,93S,90S,96S für Ausrückgabel mit Rollen / for release fork with rollers	(70)	
35.320 FFDAK 96S	06.08-			3400 700 403 ⊗ 3482 000 361 ⊗ 1878 004 832 ⊙ 3151 000 144	430 10 MFZ430 430WGTZ KZISZ-5	Getr. / GBox: ZF AS-Tronic 49S,59S,93S,90S,96S für Ausrückgabel mit Nocken / for release fork with cams	(69)	
35.320 FFDAK, FFDHLK 93S 59S	06.08-			3400 700 327 ⊗ 3482 114 031 ⊗ 1878 004 832 ⊙ 3151 263 031	430 10 GMFZ430N 430WGTZ KZIZ-6	Getr. / GBox: ZF Ecosplit-3 49S,59S,93S,90S,96S für Fahrzeuge mit Nebenantrieb / for vehicles with PTO	(73)	
35.360 FFDAK 96S	06.08-				3488 017 447	400 MFZ2/400X	Getr. / GBox: ZF Ecosplit-3 49S,59S,93S,90S,96S für Fahrzeuge mit Zweischeibenkupplung / for vehicles with double disc clutch	(77)
35.360 FFDAK, FFDHLK 93S 59S 93S	06.08-						enthält eine Kupplungsscheibe / This part number includes one clutch disc	(66)
41.320 FFDAK 93S	06.08-				1878 002 643	400 10 400WGTZ	Getr. / GBox: ZF Ecosplit-3 49S,59S,93S,90S,96S für Fahrzeuge mit Zweischeibenkupplung / for vehicles with double disc clutch	(77)
41.320 FFDAK 96S	06.08-				3151 262 031	KZISZ-5	Getr. / GBox: ZF Ecosplit-3 49S,59S,93S,90S,96S für Fahrzeuge mit Zweischeibenkupplung / for vehicles with double disc clutch	(77)
41.360 FFDAK 93S	06.08-				3496 006 000		Getr. / GBox: ZF 49S,59S,93S,90S,96S langer Bügel / long handle	(86)
41.360 FFDAK 96S	06.08-				1863 869 038		Getr. / GBox: ZF 49S,59S,93S,90S,96S	

		CODE		 Parameter		
--	--	------	--	---	---	---



















































MAN

TGS		08.07 -			
32.480 FFD-TM 49S 35.480 FFNLC 90S	08.08 -	D2676LF07, D2676LF05	 3400 700 460 HD  3482 000 246  1878 004 104  3151 000 034	430 10 MFZ430 430WGTZ KZISZ-5	Getr. / GBox: ZF Ecosplit 3 49S,59S,73S,90S,93S Abgasnorm: Euro5/Euro6 / Exhaust Emission Norm: Euro5/Euro6 (7)
	06.08 -		 3400 700 459 HD  3482 000 246  1878 004 104  3151 000 493	430 10 MFZ430 430WGTZ KZISZ-5	Getr. / GBox: ZF AS-Tronic 49S,59S,73S,90S,93S Abgasnorm: Euro5/Euro6 / Exhaust Emission Norm: Euro5/Euro6 für Ausrückgabel mit Rollen / for release fork with rollers (7) (70)
			 3151 000 144	KZISZ-5	Getr. / GBox: ZF AS-Tronic 49S,59S,73S,90S,93S Abgasnorm: Euro5/Euro6 / Exhaust Emission Norm: Euro5/Euro6 für Ausrückgabel mit Nocken / for release fork with cams (7) (69)
			 3400 700 327  3482 114 031  1878 004 832  3151 263 031	430 10 GMFZ430N 430WGTZ KZIZ-6	Getr. / GBox: ZF Ecosplit 3 49S,59S,73S,90S,93S Abgasnorm: Euro5/Euro6 / Exhaust Emission Norm: Euro5/Euro6 für Fahrzeuge mit Nebenantrieb / for vehicles with PTO für Nebenantrieb / for PTO (7) (73) (82)
			 3488 017 447	400 MFZ2/400X	Getr. / GBox: ZF Ecosplit 3 49S,59S,73S,90S,93S Abgasnorm: Euro5/Euro6 / Exhaust Emission Norm: Euro5/Euro6 für Fahrzeuge mit Zweischeibenkupplung / for vehicles with double disc clutch enthält eine Kupplungsscheibe / This part number includes one clutch disc (7) (77) (66)
			 1878 002 643	400 10 400WGTZ	Getr. / GBox: ZF Ecosplit 3 49S,59S,73S,90S,93S Abgasnorm: Euro5/Euro6 / Exhaust Emission Norm: Euro5/Euro6 für Fahrzeuge mit Zweischeibenkupplung / for vehicles with double disc clutch (7) (77)
			 3151 262 031	KZISZ-5	Getr. / GBox: ZF Ecosplit 3 49S,59S,73S,90S,93S Abgasnorm: Euro5/Euro6 / Exhaust Emission Norm: Euro5/Euro6 für Fahrzeuge mit Zweischeibenkupplung / for vehicles with double disc clutch (7) (77)
			 3496 006 000		49S,59S,73S,90S,93S Abgasnorm: Euro5/Euro6 / Exhaust Emission Norm: Euro5/Euro6 langer Bügel / long handle (7) (86)
			 1863 869 038		49S,59S,73S,90S,93S Abgasnorm: Euro5/Euro6 / Exhaust Emission Norm: Euro5/Euro6 (7)

TGS		08.07 -				
35.320 FFDLC, FFDLC, FDNLC 92S 41S 37S 35.320 FFDK, FFDLK 37S 41S 35.320 FFD-TM 37S 35.360 FFDLC, FFDLC, FDNLC 92S 41S 37S 35.360 FFDK, FFDLK, FFDK 41S 37S 35.360 FFD-TM 37S 35.400 FFDLC, FFDLC, FDNLC 92S 41S 37S 35.400 FFDK, FFDLK, FFDK 41S 37S 35.400 FFD-TM 37S	06.08 -	D2066LF43, D2066LF42, D2066LF37, D2066LF28, D2066LF27, D2066LF39, D2066LF41, D2066LF26, D2066LF38	 3400 700 380  3482 000 361  1878 080 037  3151 000 034	430 10 MFZ430 430WGTZ KZISZ-5	Getr. / GBox: ZF Ecosplit-3 37S,41S,42S,92S Abgasnorm: Euro5/Euro6 / Exhaust Emission Norm: Euro5/Euro6 (7)	
	08.08 -		 3400 700 381  3482 000 361  1878 080 037  3151 000 493	430 10 MFZ430 430WGTZ KZISZ-5	Getr. / GBox: ZF AS-Tronic 37S,41S,42S,92S Abgasnorm: Euro5/Euro6 / Exhaust Emission Norm: Euro5/Euro6 (7)	
	10.07 -					für Ausrückgabel mit Rollen / for release fork with rollers (70)
	06.08 -			 3400 700 403  3482 000 361  1878 004 832  3151 000 144	430 10 MFZ430 430WGTZ KZISZ-5	Getr. / GBox: ZF AS-Tronic 37S,41S,42S,92S Abgasnorm: Euro5/Euro6 / Exhaust Emission Norm: Euro5/Euro6 (7)
	10.07 -					für Ausrückgabel mit Nocken / for release fork with cams (69)
	06.08 -			 3400 700 327  3482 114 031  1878 004 832  3151 263 031	430 10 GMFZ430N 430WGTZ KZIZ-6	Getr. / GBox: ZF Ecosplit-3 37S,41S,42S,92S Abgasnorm: Euro5/Euro6 / Exhaust Emission Norm: Euro5/Euro6 (7)
	08.08 -					für Fahrzeuge mit Nebenantrieb / for vehicles with PTO (73)
	10.07 -					für Nebenantrieb / for PTO (82)
				 3488 017 447	400 MFZ2/400X	Getr. / GBox: ZF Ecosplit-3 37S,41S,42S,92S Abgasnorm: Euro5/Euro6 / Exhaust Emission Norm: Euro5/Euro6 (7)
						für Fahrzeuge mit Zweischeibenkupplung / for vehicles with double disc clutch (77)
					enthält eine Kupplungsscheibe / This part number includes one clutch disc (66)	
			 1878 002 643	400 10 400WGTZ	Getr. / GBox: ZF Ecosplit-3 37S,41S,42S,92S Abgasnorm: Euro5/Euro6 / Exhaust Emission Norm: Euro5/Euro6 (7)	
					für Fahrzeuge mit Zweischeibenkupplung / for vehicles with double disc clutch (77)	
			 3151 262 031	KZISZ-5	Getr. / GBox: ZF Ecosplit-3 37S,41S,42S,92S Abgasnorm: Euro5/Euro6 / Exhaust Emission Norm: Euro5/Euro6 (7)	
					für Fahrzeuge mit Zweischeibenkupplung / for vehicles with double disc clutch (77)	
			 3496 006 000		Getr. / GBox: ZF 37S,41S,42S,92S Abgasnorm: Euro5/Euro6 / Exhaust Emission Norm: Euro5/Euro6 (7)	
					langer Bügel / long handle (86)	
			 1863 869 038		Getr. / GBox: ZF 37S,41S,42S,92S Abgasnorm: Euro5/Euro6 / Exhaust Emission Norm: Euro5/Euro6 (7)	



















		CODE				
--	--	------	--	---	---	---

MAN

TGS		08.07 -				
35.440 FDNLC, FFDC, FFDLC, FFNLC 37S 41S 42S 92S 35.440 FFDK, FFDLK, FFDRK 37S 41S 35.440 FFD-TM 37S 35.440 FFNLC 90S	06.08-	D2066LF25, D2066LF36, D2066LF40	 3400 700 402  3482 000 246  1878 002 139  3151 000 034	430 10 MFZ430 430WGTZ KZISZ-5	Getr. / GBox: ZF Ecosplit 3 37S,41S,90S,92S	
	08.08-		 3400 700 460 HD  3482 000 246  1878 004 104  3151 000 034	430 10 MFZ430 430WGTZ KZISZ-5	Getr. / GBox: ZF Ecosplit 3 37S,41S,90S,92S	
	10.07-		 3400 700 381  3482 000 361  1878 080 037  3151 000 493	430 10 MFZ430 430WGTZ KZISZ-5	Getr. / GBox: ZF AS-Tronic 37S,41S,90S,92S für Ausrückgabel mit Rollen / for release fork with rollers	(70)
	06.08-		 3400 700 403  3482 000 361  1878 004 832  3151 000 144	430 10 MFZ430 430WGTZ KZISZ-5	Getr. / GBox: ZF AS-Tronic 37S,41S,90S,92S für Ausrückgabel mit Nocken / for release fork with cams	(69)
			 3400 700 327  3482 114 031  1878 004 832  3151 263 031	430 10 GMFZ430N 430WGTZ KZISZ-6	Getr. / GBox: ZF Ecosplit 3 37S,41S,90S,92S für Fahrzeuge mit Nebenantrieb / for vehicles with PTO für Nebenantrieb / for PTO	(73) (82)
			 3488 017 447	400 MFZ2/400X	Getr. / GBox: ZF Ecosplit 3 37S,41S,90S,92S für Fahrzeuge mit Zweischeibenkupplung / for vehicles with double disc clutch enthält eine Kupplungsscheibe / This part number includes one clutch disc	(77) (66)
			 1878 002 643	400 10 400WGTZ	Getr. / GBox: ZF Ecosplit 3 37S,41S,90S,92S für Fahrzeuge mit Zweischeibenkupplung / for vehicles with double disc clutch	(77)
			 3151 262 031	KZISZ-5	Getr. / GBox: ZF Ecosplit 3 37S,41S,90S,92S für Fahrzeuge mit Zweischeibenkupplung / for vehicles with double disc clutch	(77)
			 3496 006 000		37S,41S,90S,92S langer Bügel / long handle	(86)
			 1863 869 038		37S,41S,90S,92S	
35.440 FFDAK 96S 35.440 FFDAK, FFDHLK 93S 59S 35.440 FFNHLK 73S 37.440 FFDC 39S 37.440 FFDK 39S 37.440 FFD-TM 39S 41.440 FFDAK 93S 41.440 FFDAK 96S 41.440 FFDC 39S 41.440 FFDK 39S 41.440 FFD-TM 39S	06.08-	D2066LF25, D2066LF36, D2066LF40	 3400 700 402  3482 000 246  1878 002 139  3151 000 034	430 10 MFZ430 430WGTZ KZISZ-5	Getr. / GBox: ZF Ecosplit 3 39S,59S,73S,93S,96S	
	06.08-		 3400 700 460 HD  3482 000 246  1878 004 104  3151 000 034	430 10 MFZ430 430WGTZ KZISZ-5	Getr. / GBox: ZF Ecosplit 3 39S,59S,73S,93S,96S	
	10.07-		 3400 700 381  3482 000 361  1878 080 037  3151 000 493	430 10 MFZ430 430WGTZ KZISZ-5	Getr. / GBox: ZF AS-Tronic 39S,59S,73S,93S,96S für Ausrückgabel mit Rollen / for release fork with rollers	(70)
	07.08-		 3400 700 403  3482 000 361  1878 004 832  3151 000 144	430 10 MFZ430 430WGTZ KZISZ-5	Getr. / GBox: ZF AS-Tronic 39S,59S,73S,93S,96S für Ausrückgabel mit Nocken / for release fork with cams	(69)
	07.08-		 3400 700 327  3482 114 031  1878 004 832  3151 263 031	430 10 GMFZ430N 430WGTZ KZISZ-6	Getr. / GBox: ZF Ecosplit 3 39S,59S,73S,93S,96S für Fahrzeuge mit Nebenantrieb / for vehicles with PTO für Nebenantrieb / for PTO	(73) (82)
	06.08-		 3488 017 447	400 MFZ2/400X	Getr. / GBox: ZF Ecosplit 3 39S,59S,73S,93S,96S für Fahrzeuge mit Zweischeibenkupplung / for vehicles with double disc clutch enthält eine Kupplungsscheibe / This part number includes one clutch disc	(77) (66)
	06.08-		 1878 002 643	400 10 400WGTZ	Getr. / GBox: ZF Ecosplit 3 39S,59S,73S,93S,96S für Fahrzeuge mit Zweischeibenkupplung / for vehicles with double disc clutch	(77)
	07.08-		 3151 262 031	KZISZ-5	Getr. / GBox: ZF Ecosplit 3 39S,59S,73S,93S,96S für Fahrzeuge mit Zweischeibenkupplung / for vehicles with double disc clutch	(77)
	07.08-		 3496 006 000		39S,59S,73S,93S,96S langer Bügel / long handle	(86)
	10.07-		 1863 869 038		39S,59S,73S,93S,96S	





































		CODE				
--	--	------	--	---	---	---

MAN

TGS		08.07 -				
35.480 FDNLC, FFDC, FFDLC 41S 92S 37S 35.480 FFDK, FFDLK, FFDRK 41S 37S 35.480 FFD-TM 37S	06.08 -	D2676LF07, D2676LF14, D2676LF05	 3400 700 460 HD  3482 000 246  1878 004 104  3151 000 034	430 10 MFZ430 430WGTZ KZISZ-5	Getr. / GBox: ZF Ecosplit 3 37S,41S,92S,96S Abgasnorm: Euro5/Euro6 / Exhaust Emission Norm: Euro5/Euro6	(7)
	08.08 -		 3400 700 459 HD  3482 000 246  1878 004 104  3151 000 493	430 10 MFZ430 430WGTZ KZISZ-5	Getr. / GBox: ZF AS-Tronic 37S,41S,92S,96S Abgasnorm: Euro5/Euro6 / Exhaust Emission Norm: Euro5/Euro6 für Ausrückgabel mit Rollen / for release fork with rollers	(7) (70)
	10.07 -		 3151 000 144	KZISZ-5	Getr. / GBox: ZF AS-Tronic 37S,41S,92S,96S Abgasnorm: Euro5/Euro6 / Exhaust Emission Norm: Euro5/Euro6 für Ausrückgabel mit Nocken / for release fork with cams	(7) (69)
	 3400 700 327  3482 114 031  1878 004 832  3151 263 031		430 10 GMFZ430N 430WGTZ KZIZ-6	Getr. / GBox: ZF Ecosplit 3 37S,41S,92S,96S Abgasnorm: Euro5/Euro6 / Exhaust Emission Norm: Euro5/Euro6 für Fahrzeuge mit Nebenantrieb / for vehicles with PTO für Nebenantrieb / for PTO	(7) (73) (82)	
	 3488 017 447		400 MFZ2/400X	Getr. / GBox: ZF Ecosplit 3 37S,41S,92S,96S Abgasnorm: Euro5/Euro6 / Exhaust Emission Norm: Euro5/Euro6 für Fahrzeuge mit Zweischeibenkupplung / for vehicles with double disc clutch enthält eine Kupplungsscheibe / This part number includes one clutch disc	(7) (77) (66)	
	 1878 002 643		400 10 400WGTZ	Getr. / GBox: ZF Ecosplit 3 37S,41S,92S,96S Abgasnorm: Euro5/Euro6 / Exhaust Emission Norm: Euro5/Euro6 für Fahrzeuge mit Zweischeibenkupplung / for vehicles with double disc clutch	(7) (77)	
	 3151 262 031		KZISZ-5	Getr. / GBox: ZF Ecosplit 3 37S,41S,92S,96S Abgasnorm: Euro5/Euro6 / Exhaust Emission Norm: Euro5/Euro6 für Fahrzeuge mit Zweischeibenkupplung / for vehicles with double disc clutch	(7) (77)	
	 3496 006 000			37S,41S,92S,96S Abgasnorm: Euro5/Euro6 / Exhaust Emission Norm: Euro5/Euro6 langer Bügel / long handle	(7) (86)	
	 1863 869 038			37S,41S,92S,96S Abgasnorm: Euro5/Euro6 / Exhaust Emission Norm: Euro5/Euro6	(7)	









		CODE				
--	--	------	--	---	---	---

MAN

TGS		08.07 -				
35.480 FFDK 96S	06.08-	D2676LF07, D2676LF06, D2676LF05	 3400 700 460 HD  3482 000 246  1878 004 104  3151 000 034	430 10 MFZ430 430WGTZ KZISZ-5	Getr. / GBox: ZF Ecosplit 3 37S,41S,92S,96S	
35.540 FDNLC, FFDC, FFDLC 92S	06.08-		 3400 700 459 HD  3482 000 246  1878 004 104  3151 000 493	430 10 MFZ430 430WGTZ KZISZ-5	Getr. / GBox: ZF AS-Tronic 37S,41S,92S,96S für Ausrückgabel mit Rollen / for release fork with rollers	(70)
35.540 FFDK, FFDLK, FFDRK 37S 41S	02.09-		 3151 000 144	KZISZ-5	Getr. / GBox: ZF AS-Tronic 37S,41S,92S,96S für Ausrückgabel mit Nocken / for release fork with cams	(69)
41.480 FFDK 96S	06.08-		 3400 700 327  3482 114 031  1878 004 832  3151 263 031	430 10 GMFZ430N 430WGTZ KZISZ-6	Getr. / GBox: ZF Ecosplit 3 37S,41S,92S,96S für Fahrzeuge mit Nebenantrieb / for vehicles with PTO für Nebenantrieb / for PTO	(73) (82)
41.480 FFDARC 96S	06.08-		 3488 017 447	400 MFZ2/400X	Getr. / GBox: ZF Ecosplit 3 37S,41S,92S,96S für Fahrzeuge mit Zweischeibenkupplung / for vehicles with double disc clutch enthält eine Kupplungsscheibe / This part number includes one clutch disc	(77) (66)
			 1878 002 643	400 10 400WGTZ	Getr. / GBox: ZF Ecosplit 3 37S,41S,92S,96S für Fahrzeuge mit Zweischeibenkupplung / for vehicles with double disc clutch	(77)
			 3151 262 031	KZISZ-5	Getr. / GBox: ZF Ecosplit 3 37S,41S,92S,96S für Fahrzeuge mit Zweischeibenkupplung / for vehicles with double disc clutch	(77)
			 3496 006 000		37S,41S,92S,96S langer Bügel / long handle	(86)
			 1863 869 038		37S,41S,92S,96S	
35.480 FFDK, FFDHLK 93S 59S	06.08-		D2676LF14, D2676LF07, D2676LF06, D2676LF05	 3400 700 460 HD  3482 000 246  1878 004 104  3151 000 034	430 10 MFZ430 430WGTZ KZISZ-5	Getr. / GBox: ZF Ecosplit 3 49S,59S,73S,90S,93S
35.480 FFNHLC 73S	10.07-	 3400 700 459 HD  3482 000 246  1878 004 104  3151 000 493		430 10 MFZ430 430WGTZ KZISZ-5	Getr. / GBox: ZF AS-Tronic 49S,59S,73S,90S,93S für Ausrückgabel mit Rollen / for release fork with rollers	(70)
35.540 FFNLC 90S	02.09-	 3151 000 144		KZISZ-5	Getr. / GBox: ZF AS-Tronic 49S,59S,73S,90S,93S für Ausrückgabel mit Nocken / for release fork with cams	(69)
41.480 FFDK 93S	06.08-	 3400 700 327  3482 114 031  1878 004 832  3151 263 031		430 10 GMFZ430N 430WGTZ KZISZ-6	Getr. / GBox: ZF Ecosplit 3 49S,59S,73S,90S,93S für Fahrzeuge mit Nebenantrieb / for vehicles with PTO für Nebenantrieb / for PTO	(73) (82)
		 3488 017 447		400 MFZ2/400X	Getr. / GBox: ZF Ecosplit 3 49S,59S,73S,90S,93S für Fahrzeuge mit Zweischeibenkupplung / for vehicles with double disc clutch enthält eine Kupplungsscheibe / This part number includes one clutch disc	(77) (66)
		 1878 002 643		400 10 400WGTZ	Getr. / GBox: ZF Ecosplit 3 49S,59S,73S,90S,93S für Fahrzeuge mit Zweischeibenkupplung / for vehicles with double disc clutch	(77)
		 3151 262 031		KZISZ-5	Getr. / GBox: ZF Ecosplit 3 49S,59S,73S,90S,93S für Fahrzeuge mit Zweischeibenkupplung / for vehicles with double disc clutch	(77)
		 3496 006 000			49S,59S,73S,90S,93S langer Bügel / long handle	(86)
		 1863 869 038			49S,59S,73S,90S,93S	









		CODE				
--	--	------	--	---	---	---

MAN

TGS		08.07 -				
35.540 FFDK 96S	02.09-	D2676LF13, D2676LF06	 3400 700 460 HD ⊗ 3482 000 246 ⊗ 1878 004 104 ⊙ 3151 000 034	430 10 MFZ430 430WGTZ KZISZ-5	Getr. / GBox: ZF Ecosplit 3 37S,39S,93S,96S	
35.540 FFDK, FFDHLK 93S	02.09-		 3400 700 459 HD ⊗ 3482 000 246 ⊗ 1878 004 104 ⊙ 3151 000 493	430 10 MFZ430 430WGTZ KZISZ-5	Getr. / GBox: ZF AS-Tronic 37S,39S,93S,96S für Ausrückgabel mit Rollen / for release fork with rollers	(70)
35.540 FFD-TM 37S	10.07-		 3151 000 144	KZISZ-5	Getr. / GBox: ZF AS-Tronic 37S,39S,93S,96S für Ausrückgabel mit Nocken / for release fork with cams	(69)
37.540 FFDC 39S	02.09-		 3400 700 327 ⊗ 3482 114 031 ⊗ 1878 004 832 ⊙ 3151 263 031	430 10 GMFZ430N 430WGTZ KZIZ-6	Getr. / GBox: ZF Ecosplit 3 37S,39S,93S,96S für Fahrzeuge mit Nebenantrieb / for vehicles with PTO	(73)
37.540 FFDK 39S	02.09-		 3488 017 447	400 MFZ2/400X	Getr. / GBox: ZF Ecosplit 3 37S,39S,93S,96S für Fahrzeuge mit Zweischeibenkupplung / for vehicles with double disc clutch	(77)
37.540 FFDK 39S	02.09-		 1878 002 643	400 10 400WGTZ	Getr. / GBox: ZF Ecosplit 3 37S,39S,93S,96S für Fahrzeuge mit Zweischeibenkupplung / for vehicles with double disc clutch	(66)
37.540 FFD-TM 39S	10.07-		 3151 262 031	KZISZ-5	Getr. / GBox: ZF Ecosplit 3 37S,39S,93S,96S für Fahrzeuge mit Zweischeibenkupplung / for vehicles with double disc clutch	(77)
			 3496 006 000		37S,39S,93S,96S langer Bügel / long handle	(86)
			 1863 869 038		37S,39S,93S,96S	









		CODE				
--	--	------	--	---	---	---



MAN

TGS		08.07 -				
37.320 FFDC 39S	07.08-	D2066LF43, D2066LF42, D2066LF37, D2066LF28, D2066LF27, D2066LF39, D2066LF41, D2066LF26, D2066LF38	 3400 700 380 ⊗ 3482 000 361 ⊗ 1878 080 037 ⊙ 3151 000 034	430 10 MFZ430 430WGTZ KZISZ-5	Getr. / GBox: ZF Ecosplit-3 39S Abgasnorm: Euro4/Euro5 / Exhaust Emission Norm: Euro4/Euro5 Abgasnorm: Euro 6 / Exhaust Emission Norm: Euro 6	(6) (4)
37.320 FFDC 39S	07.08-		 3400 700 381 ⊗ 3482 000 361 ⊗ 1878 080 037 ⊙ 3151 000 493	430 10 MFZ430 430WGTZ KZISZ-5	Getr. / GBox: ZF AS-Tronic 39S Abgasnorm: Euro4/Euro5 / Exhaust Emission Norm: Euro4/Euro5 Abgasnorm: Euro 6 / Exhaust Emission Norm: Euro 6 für Ausrückgabel mit Rollen / for release fork with rollers	(6) (4) (70)
37.320 FFD-TM 39S	10.07-		 3400 700 403 ⊗ 3482 000 361 ⊗ 1878 004 832 ⊙ 3151 000 144	430 10 MFZ430 430WGTZ KZISZ-5	Getr. / GBox: ZF AS-Tronic 39S Abgasnorm: Euro4/Euro5 / Exhaust Emission Norm: Euro4/Euro5 Abgasnorm: Euro 6 / Exhaust Emission Norm: Euro 6 für Ausrückgabel mit Nocken / for release fork with cams	(6) (4) (69)
37.360 FFDC 39S	07.08-		 3400 700 327 ⊗ 3482 114 031 ⊗ 1878 004 832 ⊙ 3151 263 031	430 10 GMFZ430N 430WGTZ KZISZ-6	Getr. / GBox: ZF Ecosplit-3 39S Abgasnorm: Euro4/Euro5 / Exhaust Emission Norm: Euro4/Euro5 Abgasnorm: Euro 6 / Exhaust Emission Norm: Euro 6 für Fahrzeuge mit Nebenantrieb / for vehicles with PTO	(6) (4) (73)
37.360 FFD-TM 39S	10.07-		 3488 017 447	400 MFZ2/400X	Getr. / GBox: ZF Ecosplit-3 39S Abgasnorm: Euro4/Euro5 / Exhaust Emission Norm: Euro4/Euro5 Abgasnorm: Euro 6 / Exhaust Emission Norm: Euro 6 für Fahrzeuge mit Zweischeibenkupplung / for vehicles with double disc clutch enthält eine Kupplungsscheibe / This part number includes one clutch disc	(6) (4) (77) (66)
37.400 FFDC 39S	07.08-		 1878 002 643	400 10 400WGTZ	Getr. / GBox: ZF Ecosplit-3 39S Abgasnorm: Euro4/Euro5 / Exhaust Emission Norm: Euro4/Euro5 Abgasnorm: Euro 6 / Exhaust Emission Norm: Euro 6 für Fahrzeuge mit Zweischeibenkupplung / for vehicles with double disc clutch	(6) (4) (77)
37.400 FFDK 39S	07.08-		 3151 262 031	KZISZ-5	Getr. / GBox: ZF Ecosplit-3 39S Abgasnorm: Euro4/Euro5 / Exhaust Emission Norm: Euro4/Euro5 Abgasnorm: Euro 6 / Exhaust Emission Norm: Euro 6 für Fahrzeuge mit Zweischeibenkupplung / for vehicles with double disc clutch	(6) (4) (77)
37.400 FFD-TM 39S	10.07-		 3496 006 000		Getr. / GBox: ZF 39S Abgasnorm: Euro4/Euro5 / Exhaust Emission Norm: Euro4/Euro5 Abgasnorm: Euro 6 / Exhaust Emission Norm: Euro 6 langer Bügel / long handle	(6) (4) (86)
41.360 FFDC 39S	07.08-		 1863 869 038		Getr. / GBox: ZF 39S Abgasnorm: Euro4/Euro5 / Exhaust Emission Norm: Euro4/Euro5 Abgasnorm: Euro 6 / Exhaust Emission Norm: Euro 6	(6) (4)

		CODE					
--	--	------	--	--	---	---	---











































MAN

TGS		08.07 -					
37.480 FFDC 39S 37.480 FFDC 39S 37.480 FFD-TM 39S 41.480 FFDC 39S 41.480 FFDC 39S 41.480 FFD-TM 39S	07.08-	D2676LF07, D2676LF14, D2676LF05		3400 700 460 HD ⊗ 3482 000 246 ⊗ 1878 004 104 ⊙ 3151 000 034	430 10 MFZ430 430WGTZ KZISZ-5	Getr. / GBox: ZF Ecosplit 3 37S,39S,93S,96S Abgasnorm: Euro4/Euro5 / Exhaust Emission Norm: Euro4/Euro5 Abgasnorm: Euro 6 / Exhaust Emission Norm: Euro 6	(6) (4)
	07.08-			3400 700 459 HD ⊗ 3482 000 246 ⊗ 1878 004 104 ⊙ 3151 000 493	430 10 MFZ430 430WGTZ KZISZ-5	Getr. / GBox: ZF AS-Tronic 37S,39S,93S,96S Abgasnorm: Euro4/Euro5 / Exhaust Emission Norm: Euro4/Euro5 Abgasnorm: Euro 6 / Exhaust Emission Norm: Euro 6 für Ausrückgabel mit Rollen / for release fork with rollers	(6) (4) (70)
	10.07-			3151 000 144	KZISZ-5	Getr. / GBox: ZF AS-Tronic 37S,39S,93S,96S Abgasnorm: Euro4/Euro5 / Exhaust Emission Norm: Euro4/Euro5 Abgasnorm: Euro 6 / Exhaust Emission Norm: Euro 6 für Ausrückgabel mit Nocken / for release fork with cams	(6) (4) (69)
	07.08-			3400 700 327 ⊗ 3482 114 031 ⊗ 1878 004 832 ⊙ 3151 263 031	430 10 GMFZ430N 430WGTZ KZIZ-6	Getr. / GBox: ZF Ecosplit 3 37S,39S,93S,96S Abgasnorm: Euro4/Euro5 / Exhaust Emission Norm: Euro4/Euro5 Abgasnorm: Euro 6 / Exhaust Emission Norm: Euro 6 für Fahrzeuge mit Nebenantrieb / for vehicles with PTO für Nebenantrieb / for PTO	(6) (4) (73) (82)
	07.08-			3488 017 447	400 MFZ2/400X	Getr. / GBox: ZF Ecosplit 3 37S,39S,93S,96S Abgasnorm: Euro4/Euro5 / Exhaust Emission Norm: Euro4/Euro5 Abgasnorm: Euro 6 / Exhaust Emission Norm: Euro 6 für Fahrzeuge mit Zweischeibenkupplung / for vehicles with double disc clutch enthält eine Kupplungsscheibe / This part number includes one clutch disc	(6) (4) (77) (66)
	10.07-			1878 002 643	400 10 400WGTZ	Getr. / GBox: ZF Ecosplit 3 37S,39S,93S,96S Abgasnorm: Euro4/Euro5 / Exhaust Emission Norm: Euro4/Euro5 Abgasnorm: Euro 6 / Exhaust Emission Norm: Euro 6 für Fahrzeuge mit Zweischeibenkupplung / for vehicles with double disc clutch	(6) (4) (77)
				3151 262 031	KZISZ-5	Getr. / GBox: ZF Ecosplit 3 37S,39S,93S,96S Abgasnorm: Euro4/Euro5 / Exhaust Emission Norm: Euro4/Euro5 Abgasnorm: Euro 6 / Exhaust Emission Norm: Euro 6 für Fahrzeuge mit Zweischeibenkupplung / for vehicles with double disc clutch	(6) (4) (77)
				3496 006 000		37S,39S,93S,96S Abgasnorm: Euro4/Euro5 / Exhaust Emission Norm: Euro4/Euro5 Abgasnorm: Euro 6 / Exhaust Emission Norm: Euro 6 langer Bügel / long handle	(6) (4) (86)
				1863 869 038		37S,39S,93S,96S Abgasnorm: Euro4/Euro5 / Exhaust Emission Norm: Euro4/Euro5 Abgasnorm: Euro 6 / Exhaust Emission Norm: Euro 6	(6) (4)

TGX		09.07 -					
TGX Euro 6	01.14-	D3876LF		3400 700 613 ⊗ 3482 001 145 ⊗ 1878 007 126 ⊙ 3151 000 493	430 10 MZ430 430WGTPZ KZISZ-5	Getr. / GBox: AS Tronic Abgasnorm: Euro 6 / Exhaust Emission Norm: Euro 6	(4)
				3400 700 614 ⊗ 3482 001 180 ⊗ 1878 007 126	430 10 M430 430WGTPZ	Getr. / GBox: Traxon Abgasnorm: Euro 6 / Exhaust Emission Norm: Euro 6	(4)
				6482 000 216	PHIS-6/38	Getr. / GBox: Traxon Abgasnorm: Euro 6 / Exhaust Emission Norm: Euro 6 Immer erneuern / Renew everytime	(4) (28)















































		CODE				
--	--	------	--	---	---	---

MAN

TGX		09.07 -					
18.360 FHLC 22X 18.360 FHLS, FHLS/M 22X 18.400 FHLC 22X 18.400 FHLS, FHLS/M 22X 26.360 FDHLC 70X 26.360 FDHLS 70X 26.360 FNHLC 35X 26.360 FNHLS 35X 26.400 FDHLC 70X 26.400 FDHLS 70X 26.400 FNHLS 35X 26.400 FNHLC 35X	10.07 -	D2066LF37, D2066LF27, D2066LF42, D2066LF41, D2066LF26, D2066LF61, D2066LF38	 3400 700 380  3482 000 361  1878 080 037  3151 000 034	430 10 MFZ430 430WGTZ KZISZ-5	Getr. / GBox: ZF Ecosplit 3 22X,35X,70X		
		10.07 -		 3400 700 381  3482 000 361  1878 080 037  3151 000 493	430 10 MFZ430 430WGTZ KZISZ-5	Getr. / GBox: ZF AS-Tronic 22X,35X,70X für Ausrückgabel mit Rollen / for release fork with rollers	(70)
		10.07 -		 3400 700 403  3482 000 361  1878 004 832  3151 000 144	430 10 MFZ430 430WGTZ KZISZ-5	Getr. / GBox: ZF AS-Tronic 22X,35X,70X für Ausrückgabel mit Nocken / for release fork with cams	(69)
		10.07 -		 3400 700 327  3482 114 031  1878 004 832  3151 263 031	430 10 GMFZ430N 430WGTZ KZIZ-6	Getr. / GBox: ZF Ecosplit 3 22X,35X,70X für Fahrzeuge mit Nebenantrieb / for vehicles with PTO	(73)
		12.07 -		 3488 017 447	400 MFZ2/400X	Getr. / GBox: ZF Ecosplit 3 22X,35X,70X für Fahrzeuge mit Zweischeibenkupplung / for vehicles with double disc clutch	(77)
		10.07 -				enthält eine Kupplungsscheibe / This part number includes one clutch disc	(66)
		10.07 -		 1878 002 643	400 10 400WGTZ	Getr. / GBox: ZF Ecosplit 3 22X,35X,70X für Fahrzeuge mit Zweischeibenkupplung / for vehicles with double disc clutch	(77)
		12.07 -		 3151 262 031	KZISZ-5	Getr. / GBox: ZF Ecosplit 3 22X,35X,70X für Fahrzeuge mit Zweischeibenkupplung / for vehicles with double disc clutch	(77)
		12.07 -		 3496 006 000		22X,35X,70X langer Bügel / long handle	(86)
				 1863 869 038		22X,35X,70X	
18.360 FLC, FLRC, FLLC, FLLRC, FLLW, FLLW/N 06X 15X 10X 18.360 FLS, FLS/M, FLRS, FLRS/N, FLLS, FLLS/N, FLLRS, FLLRS/N 10X 06X 15X 13X 18.400 FLC, FLRC, FLLC, FLLRC, FLLW, FLLW/N 06X 15X 10X	10.07 -	D2066LF27, D2066LF42, D2066LF37, D2066LF41, D2066LF26, D2066LF52, D2066LF61, D2066LF67, D2066LF38, D2066LF51	 3400 700 380  3482 000 361  1878 080 037  3151 000 034	430 10 MFZ430 430WGTZ KZISZ-5	Getr. / GBox: ZF Ecosplit 3 06X,10X,13X,15X		
		10.07 -		 3400 700 381  3482 000 361  1878 080 037  3151 000 493	430 10 MFZ430 430WGTZ KZISZ-5	Getr. / GBox: ZF AS-Tronic 06X,10X,13X,15X für Ausrückgabel mit Rollen / for release fork with rollers	(70)
		10.07 -		 3400 700 403  3482 000 361  1878 004 832  3151 000 144	430 10 MFZ430 430WGTZ KZISZ-5	Getr. / GBox: ZF AS-Tronic 06X,10X,13X,15X für Ausrückgabel mit Nocken / for release fork with cams	(69)
				 3400 700 327  3482 114 031  1878 004 832  3151 263 031	430 10 GMFZ430N 430WGTZ KZIZ-6	Getr. / GBox: ZF Ecosplit 3 06X,10X,13X,15X für Fahrzeuge mit Nebenantrieb / for vehicles with PTO	(73)
				 3488 017 447	400 MFZ2/400X	Getr. / GBox: ZF Ecosplit 3 06X,10X,13X,15X für Fahrzeuge mit Zweischeibenkupplung / for vehicles with double disc clutch	(77)
						enthält eine Kupplungsscheibe / This part number includes one clutch disc	(66)
				 1878 002 643	400 10 400WGTZ	Getr. / GBox: ZF Ecosplit 3 06X,10X,13X,15X für Fahrzeuge mit Zweischeibenkupplung / for vehicles with double disc clutch	(77)
				 3151 262 031	KZISZ-5	Getr. / GBox: ZF Ecosplit 3 06X,10X,13X,15X für Fahrzeuge mit Zweischeibenkupplung / for vehicles with double disc clutch	(77)
				 3496 006 000		06X,10X,13X,15X langer Bügel / long handle	(86)
				 1863 869 038		06X,10X,13X,15X	











































		CODE				
--	--	------	--	---	---	---









































MAN

TGX		09.07 -					
18.400 FLS, FLS/M, FLRS, FLRS/N, FLLS, FLLS/N, FLLRS, FLLRS/N 06X 13X 05X 10X	10.07 -	D2066LF37, D2066LF41, D2066LF26, D2066LF61, D2066LF51	 3400 700 380  3482 000 361  1878 080 037  3151 000 034	430 10 MFZ430 430WGTZ KZISZ-5	Getr. / GBox: ZF Ecosplit 3 05X,06X,10X,13X,15X		
			 3400 700 381  3482 000 361  1878 080 037  3151 000 493	430 10 MFZ430 430WGTZ KZISZ-5	Getr. / GBox: ZF AS-Tronic 05X,06X,10X,13X,15X für Ausrückgabel mit Rollen / for release fork with rollers	(70)	
			 3400 700 403  3482 000 361  1878 004 832  3151 000 144	430 10 MFZ430 430WGTZ KZISZ-5	Getr. / GBox: ZF AS-Tronic 05X,06X,10X,13X,15X für Ausrückgabel mit Nocken / for release fork with cams	(69)	
			 3400 700 327  3482 114 031  1878 004 832  3151 263 031	430 10 GMFZ430N 430WGTZ KZISZ-6	Getr. / GBox: ZF Ecosplit 3 05X,06X,10X,13X,15X für Fahrzeuge mit Nebenantrieb / for vehicles with PTO für Nebenantrieb / for PTO	(73) (82)	
			 3488 017 447	400 MFZ2/400X	Getr. / GBox: ZF Ecosplit 3 05X,06X,10X,13X,15X für Fahrzeuge mit Zweischeibenkupplung / for vehicles with double disc clutch enthält eine Kupplungsscheibe / This part number includes one clutch disc	(77) (66)	
			 1878 002 643	400 10 400WGTZ	Getr. / GBox: ZF Ecosplit 3 05X,06X,10X,13X,15X für Fahrzeuge mit Zweischeibenkupplung / for vehicles with double disc clutch	(77)	
			 3151 262 031	KZISZ-5	Getr. / GBox: ZF Ecosplit 3 05X,06X,10X,13X,15X für Fahrzeuge mit Zweischeibenkupplung / for vehicles with double disc clutch	(77)	
			 3496 006 000		05X,06X,10X,13X,15X langer Bügel / long handle	(86)	
			 1863 869 038		05X,06X,10X,13X,15X		
18.440 FHLC 22X 18.440 FHLS, FHLS/M 22X 26.440 FDHLC 70X 26.440 FDHLS 70X 26.440 FNHLC 35X 26.440 FNHLS 35X	10.07 -	D2066LF25, D2066LF36, D2066LF40	 3400 700 402  3482 000 246  1878 002 139  3151 000 034	430 10 MFZ430 430WGTZ KZISZ-5	Getr. / GBox: ZF Ecosplit 3 22X,35X,70X		
	10.07 -		 3400 700 460 HD  3482 000 246  1878 004 104  3151 000 034	430 10 MFZ430 430WGTZ KZISZ-5	Getr. / GBox: ZF Ecosplit 3 22X,35X,70X		
	09.07 -		 3400 700 381  3482 000 361  1878 080 037  3151 000 493	430 10 MFZ430 430WGTZ KZISZ-5	Getr. / GBox: ZF AS-Tronic 22X,35X,70X für Ausrückgabel mit Rollen / for release fork with rollers	(70)	
	10.07 -		 3400 700 403  3482 000 361  1878 004 832  3151 000 144	430 10 MFZ430 430WGTZ KZISZ-5	Getr. / GBox: ZF AS-Tronic 22X,35X,70X für Ausrückgabel mit Nocken / for release fork with cams	(69)	
	12.07 -		 3400 700 327  3482 114 031  1878 004 832  3151 263 031	430 10 GMFZ430N 430WGTZ KZISZ-6	Getr. / GBox: ZF Ecosplit 3 22X,35X,70X für Fahrzeuge mit Nebenantrieb / for vehicles with PTO für Nebenantrieb / for PTO	(73) (82)	
	12.07 -		 3488 017 447	400 MFZ2/400X	Getr. / GBox: ZF Ecosplit 3 22X,35X,70X für Fahrzeuge mit Zweischeibenkupplung / for vehicles with double disc clutch enthält eine Kupplungsscheibe / This part number includes one clutch disc	(77) (66)	
			 1878 002 643	400 10 400WGTZ	Getr. / GBox: ZF Ecosplit 3 22X,35X,70X für Fahrzeuge mit Zweischeibenkupplung / for vehicles with double disc clutch	(77)	
			 3151 262 031	KZISZ-5	Getr. / GBox: ZF Ecosplit 3 22X,35X,70X für Fahrzeuge mit Zweischeibenkupplung / for vehicles with double disc clutch	(77)	
			 3496 006 000		22X,35X,70X langer Bügel / long handle	(86)	
			 1863 869 038		22X,35X,70X		

		CODE				
--	--	------	--	---	---	---



















MAN





































TGX		09.07 -				
18.440 FHLS, FHLS/M 22X 24.440 FNLLW/N 45X 26.440 FDS, FDS/M, FDLS, FDLS/M, FDRS, FDRS/M, FDLRS 30X 26X 26.440 FNLC, FNLC, FNLLC, FNLLRC, FNLLW 18X 21X 26.440 FNLS, FNLLS, FNLRs, FNLLRS, FPLS, FPLRS, FVLS 18X 24X 21X 28.440 FNLC 89X 28.440 FNLS 89X 33.440 FDC, FDC/M, FDLC 26X 30X 33.440 FDS, FDS/M, FDLS, FDLS/M 26X 30X	10.12-	D2676LF26	 3400 700 460 HD  3482 000 246  1878 004 104  3151 000 034	430 10 MFZ430 430WGTZ KZISZ-5	Getr. / GBox: ZF Ecosplit 3 Abgasnorm: Euro 6 / Exhaust Emission Norm: Euro 6	(4)
	10.12-		 3400 700 459 HD  3482 000 246  1878 004 104  3151 000 493	430 10 MFZ430 430WGTZ KZISZ-5	Getr. / GBox: ZF AS-Tronic Abgasnorm: Euro 6 / Exhaust Emission Norm: Euro 6 für Ausrückgabel mit Rollen / for release fork with rollers	(4) (70)
	10.12-		 3151 000 144	KZISZ-5	Getr. / GBox: ZF AS-Tronic Abgasnorm: Euro 6 / Exhaust Emission Norm: Euro 6 für Ausrückgabel mit Nocken / for release fork with cams	(4) (69)
	10.12-		 3400 700 327  3482 114 031  1878 004 832  3151 263 031	430 10 GMFZ430N 430WGTZ KZISZ-6	Getr. / GBox: ZF Ecosplit 3 Abgasnorm: Euro 6 / Exhaust Emission Norm: Euro 6 für Fahrzeuge mit Nebenantrieb / for vehicles with PTO	(4) (73) (82)
	10.12-		 3488 017 447	400 MFZ2/400X	Getr. / GBox: ZF Ecosplit 3 Abgasnorm: Euro 6 / Exhaust Emission Norm: Euro 6 für Fahrzeuge mit Zweis Scheibenkupplung / for vehicles with double disc clutch enthält eine Kupplungsscheibe / This part number includes one clutch disc	(4) (77) (66)
	10.12-		 1878 002 643	400 10 400WGTZ	Getr. / GBox: ZF Ecosplit 3 Abgasnorm: Euro 6 / Exhaust Emission Norm: Euro 6 für Fahrzeuge mit Zweis Scheibenkupplung / for vehicles with double disc clutch	(4) (77)
	10.12-		 3151 262 031	KZISZ-5	Getr. / GBox: ZF Ecosplit 3 Abgasnorm: Euro 6 / Exhaust Emission Norm: Euro 6 für Fahrzeuge mit Zweis Scheibenkupplung / for vehicles with double disc clutch	(4) (77)
	10.12-		 3496 006 000		Abgasnorm: Euro 6 / Exhaust Emission Norm: Euro 6 langer Bügel / long handle	(4) (86)
	10.12-		 1863 869 038		Abgasnorm: Euro 6 / Exhaust Emission Norm: Euro 6	(4)
	18.440 FLC, FLRC, FLLC, FLLRC, FLLW, FLLW/N 15X 10X 06X 18.440 FLS, FLS/M, FLRS, FLRS/M, FLLS, FLLS/N, FLLRS, FLLRS/ 10X 05X 13X 06X		10.07-	D2066LF25, D2066LF36, D2066LF40	 3400 700 402  3482 000 246  1878 002 139  3151 000 034	430 10 MFZ430 430WGTZ KZISZ-5
10.07-		 3400 700 460 HD  3482 000 246  1878 004 104  3151 000 034	430 10 MFZ430 430WGTZ KZISZ-5		Getr. / GBox: ZF Ecosplit 3 05X,06X10X,13X,15X	
		 3400 700 381  3482 000 361  1878 080 037  3151 000 493	430 10 MFZ430 430WGTZ KZISZ-5		Getr. / GBox: ZF AS-Tronic 05X,06X10X,13X,15X für Ausrückgabel mit Rollen / for release fork with rollers	(70)
		 3400 700 403  3482 000 361  1878 004 832  3151 000 144	430 10 MFZ430 430WGTZ KZISZ-5		Getr. / GBox: ZF AS-Tronic 05X,06X10X,13X,15X für Ausrückgabel mit Nocken / for release fork with cams	(69)
		 3400 700 327  3482 114 031  1878 004 832  3151 263 031	430 10 GMFZ430N 430WGTZ KZISZ-6		Getr. / GBox: ZF Ecosplit 3 05X,06X10X,13X,15X für Fahrzeuge mit Nebenantrieb / for vehicles with PTO	(73) (82)
		 3488 017 447	400 MFZ2/400X		Getr. / GBox: ZF Ecosplit 3 05X,06X10X,13X,15X für Fahrzeuge mit Zweis Scheibenkupplung / for vehicles with double disc clutch enthält eine Kupplungsscheibe / This part number includes one clutch disc	(77) (66)
		 1878 002 643	400 10 400WGTZ		Getr. / GBox: ZF Ecosplit 3 05X,06X10X,13X,15X für Fahrzeuge mit Zweis Scheibenkupplung / for vehicles with double disc clutch	(77)
		 3151 262 031	KZISZ-5		Getr. / GBox: ZF Ecosplit 3 05X,06X10X,13X,15X für Fahrzeuge mit Zweis Scheibenkupplung / for vehicles with double disc clutch	(77)
		 3496 006 000			05X,06X10X,13X,15X langer Bügel / long handle	(86)
		 1863 869 038			05X,06X10X,13X,15X	

TGX		09.07 -						
18.480 FHLC 22X 18.480 FHLS, FHLS/M 22X 18.540 FHLC 22X 18.540 FHLS, FHLS/M 22X	10.07-	D2676LF14, D2676LF07, D2676LF13, D2676LF06, D2676LF05, D2676LF25	 3400 700 460 HD  3482 000 246  1878 004 104  3151 000 034	430 10 MFZ430 430WGTZ KZISZ-5	Getr. / GBox: ZF Ecosplit 3 22X			
	10.07-		 3400 700 459 HD  3482 000 246  1878 004 104  3151 000 493	430 10 MFZ430 430WGTZ KZISZ-5	Getr. / GBox: ZF AS-Tronic 22X für Ausrückgabel mit Rollen / for release fork with rollers	(70)		
	10.07-		 3151 000 144	KZISZ-5	Getr. / GBox: ZF AS-Tronic 22X für Ausrückgabel mit Nocken / for release fork with cams	(69)		
	10.07-		 3400 700 327  3482 114 031  1878 004 832  3151 263 031	430 10 GMFZ430N 430WGTZ KZISZ-6	Getr. / GBox: ZF Ecosplit 3 22X für Fahrzeuge mit Nebenantrieb / for vehicles with PTO für Nebenantrieb / for PTO	(73) (82)		
	10.07-		 3488 017 447	400 MFZ2/400X	Getr. / GBox: ZF Ecosplit 3 22X für Fahrzeuge mit Zweischeibenkupplung / for vehicles with double disc clutch enthält eine Kupplungsscheibe / This part number includes one clutch disc	(77) (66)		
	10.07-		 1878 002 643	400 10 400WGTZ	Getr. / GBox: ZF Ecosplit 3 22X für Fahrzeuge mit Zweischeibenkupplung / for vehicles with double disc clutch	(77)		
	10.07-		 3151 262 031	KZISZ-5	Getr. / GBox: ZF Ecosplit 3 22X für Fahrzeuge mit Zweischeibenkupplung / for vehicles with double disc clutch	(77)		
	10.07-		 3496 006 000		22X langer Bügel / long handle	(86)		
	10.07-		 1863 869 038		22X			
	18.480 FLC, FLRC, FLLC, FLLRC, FLLW, FLLW/N 15X 06X 10X 18.480 FLS, FLS/M, FLRS, FLRS/N, FLLS, FLLS/N 13X 10X 06X 05X 18.540 FLC, FLRC, FLLC, FLLRC, FLLW, FLLW/N 15X 06X 10X 18.540 FLS, FLS/M, FLRS, FLRS/N, FLLS, FLLS/N 13X 06X 10X 05X		10.07-	D2676LF07, D2676LF14, D2676LF13, D2676LF06, D2676LF05, D2676LF21, D2676LF25	 3400 700 460 HD  3482 000 246  1878 004 104  3151 000 034	430 10 MFZ430 430WGTZ KZISZ-5	Getr. / GBox: ZF Ecosplit 3 05X,06X,10X,13X,15X	
10.07-		 3400 700 459 HD  3482 000 246  1878 004 104  3151 000 493	430 10 MFZ430 430WGTZ KZISZ-5		Getr. / GBox: ZF AS-Tronic 05X,06X,10X,13X,15X für Ausrückgabel mit Rollen / for release fork with rollers	(70)		
10.07-		 3151 000 144	KZISZ-5		Getr. / GBox: ZF AS-Tronic 05X,06X,10X,13X,15X für Ausrückgabel mit Nocken / for release fork with cams	(69)		
10.07-		 3400 700 327  3482 114 031  1878 004 832  3151 263 031	430 10 GMFZ430N 430WGTZ KZISZ-6		Getr. / GBox: ZF Ecosplit 3 05X,06X,10X,13X,15X für Fahrzeuge mit Nebenantrieb / for vehicles with PTO für Nebenantrieb / for PTO	(73) (82)		
10.07-		 3488 017 447	400 MFZ2/400X		Getr. / GBox: ZF Ecosplit 3 05X,06X,10X,13X,15X für Fahrzeuge mit Zweischeibenkupplung / for vehicles with double disc clutch enthält eine Kupplungsscheibe / This part number includes one clutch disc	(77) (66)		
10.07-		 1878 002 643	400 10 400WGTZ		Getr. / GBox: ZF Ecosplit 3 05X,06X,10X,13X,15X für Fahrzeuge mit Zweischeibenkupplung / for vehicles with double disc clutch	(77)		
10.07-		 3151 262 031	KZISZ-5		Getr. / GBox: ZF Ecosplit 3 05X,06X,10X,13X,15X für Fahrzeuge mit Zweischeibenkupplung / for vehicles with double disc clutch	(77)		
10.07-		 3496 006 000			05X,06X,10X,13X,15X langer Bügel / long handle	(86)		
10.07-		 1863 869 038			05X,06X,10X,13X,15X			
18.680 FLS 78X 33.680 FDLC 79X 33.680 FDLs 79X 41.680 FVDS, FVDLS 95X 94X		10.07-	D2868LF03, D2868LF02, D2868LF06, D2868LF05		 3400 700 494  3482 000 819  1878 005 411  3151 000 493	430 10 MFZ430 430WGTZ KZISZ-5	Getr. / GBox: ZF AS-Tronic	
	10.07-	 1863 869 038						
	10.07-							

		CODE				
--	--	------	--	---	---	---



















MAN





















TGX		09.07 -				
24.360 FNLLW/N 45X 24.360 FPLS, FPLRS 24X 45X 24.400 FNLLW/N 45X 24.400 FPLS, FPLRS 24X 45X 26.360 FVHLS 42X 26.400 FPHLS 42X 26.400 FVHLS 42X	10.07 -	D2066LF37, D2066LF27, D2066LF42, D2066LF41, D2066LF26, D2066LF52, D2066LF61, D2066LF67, D2066LF38, D2066LF51	 3400 700 380 ⊗ 3482 000 361 ⊗ 1878 080 037 ⊙ 3151 000 034	430 10 MFZ430 430WGTZ KZISZ-5	Getr. / GBox: ZF Ecosplit 3 24X,42X,45X	
	10.07 -		 3400 700 381 ⊗ 3482 000 361 ⊗ 1878 080 037 ⊙ 3151 000 493	430 10 MFZ430 430WGTZ KZISZ-5	Getr. / GBox: ZF AS-Tronic 24X,42X,45X für Ausrückgabel mit Rollen / for release fork with rollers	(70)
	10.07 -		 3400 700 403 ⊗ 3482 000 361 ⊗ 1878 004 832 ⊙ 3151 000 144	430 10 MFZ430 430WGTZ KZISZ-5	Getr. / GBox: ZF AS-Tronic 24X,42X,45X für Ausrückgabel mit Nocken / for release fork with cams	(69)
	05.08 -		 3400 700 327 ⊗ 3482 114 031 ⊗ 1878 004 832 ⊙ 3151 263 031	430 10 GMFZ430N 430WGTZ KZIZ-6	Getr. / GBox: ZF Ecosplit 3 24X,42X,45X für Fahrzeuge mit Nebenantrieb / for vehicles with PTO für Nebenantrieb / for PTO	(73) (82)
	05.08 -		 3488 017 447	400 MFZ2/400X	Getr. / GBox: ZF Ecosplit 3 24X,42X,45X für Fahrzeuge mit Zweischeibenkupplung / for vehicles with double disc clutch enthält eine Kupplungsscheibe / This part number includes one clutch disc	(77) (66)
	05.08 -		 1878 002 643	400 10 400WGTZ	Getr. / GBox: ZF Ecosplit 3 24X,42X,45X für Fahrzeuge mit Zweischeibenkupplung / for vehicles with double disc clutch	(77)
			 3151 262 031	KZISZ-5	Getr. / GBox: ZF Ecosplit 3 24X,42X,45X für Fahrzeuge mit Zweischeibenkupplung / for vehicles with double disc clutch	(77)
			 3496 006 000		24X,42X,45X langer Bügel / long handle	(86)
			 1863 869 038		24X,42X,45X	
	24.440 FNLLW/N 45X 24.440 FPLS, FPLRS 45X 24X 26.440 FPHLS 42X 26.440 FVHLS 42X		10.07 -	D2066LF25, D2066LF36, D2066LF40	 3400 700 402 ⊗ 3482 000 246 ⊗ 1878 002 139 ⊙ 3151 000 034	430 10 MFZ430 430WGTZ KZISZ-5
10.07 -		 3400 700 460 HD ⊗ 3482 000 246 ⊗ 1878 004 104 ⊙ 3151 000 034	430 10 MFZ430 430WGTZ KZISZ-5		Getr. / GBox: ZF Ecosplit 3 24X,42X,45X	
05.08 -		 3400 700 381 ⊗ 3482 000 361 ⊗ 1878 080 037 ⊙ 3151 000 493	430 10 MFZ430 430WGTZ KZISZ-5		Getr. / GBox: ZF AS-Tronic 24X,42X,45X für Ausrückgabel mit Rollen / for release fork with rollers	(70)
05.08 -		 3400 700 403 ⊗ 3482 000 361 ⊗ 1878 004 832 ⊙ 3151 000 144	430 10 MFZ430 430WGTZ KZISZ-5		Getr. / GBox: ZF AS-Tronic 24X,42X,45X für Ausrückgabel mit Nocken / for release fork with cams	(69)
		 3400 700 327 ⊗ 3482 114 031 ⊗ 1878 004 832 ⊙ 3151 263 031	430 10 GMFZ430N 430WGTZ KZIZ-6		Getr. / GBox: ZF Ecosplit 3 24X,42X,45X für Fahrzeuge mit Nebenantrieb / for vehicles with PTO für Nebenantrieb / for PTO	(73) (82)
		 3488 017 447	400 MFZ2/400X		Getr. / GBox: ZF Ecosplit 3 24X,42X,45X für Fahrzeuge mit Zweischeibenkupplung / for vehicles with double disc clutch enthält eine Kupplungsscheibe / This part number includes one clutch disc	(77) (66)
		 1878 002 643	400 10 400WGTZ		Getr. / GBox: ZF Ecosplit 3 24X,42X,45X für Fahrzeuge mit Zweischeibenkupplung / for vehicles with double disc clutch	(77)
		 3151 262 031	KZISZ-5		Getr. / GBox: ZF Ecosplit 3 24X,42X,45X für Fahrzeuge mit Zweischeibenkupplung / for vehicles with double disc clutch	(77)
		 3496 006 000			24X,42X,45X langer Bügel / long handle	(86)
		 1863 869 038			24X,42X,45X	

TGX		09.07 -						
24.480 FNLLW/N 45X 24.480 FPLS, FPLRS 45X 24X 24.540 FPLS, FPLRS 24X 45X 26.480 FDHLC 70X 26.480 FDHLS 70X 26.480 FNHLC 35X 26.480 FNHLS 35X 26.480 FPHLS 42X 26.480 FVHLS 42X	10.07 -	D2676LF07, D2676LF14, D2676LF13, D2676LF06, D2676LF05, D2676LF25, D2676LF21	 3400 700 460 HD  3482 000 246  1878 004 104  3151 000 034	430 10 MFZ430 430WGTZ KZISZ-5	Getr. / GBox: ZF Ecosplit 3 24X,35X,42X,45X,70X			
	10.07 -		 3400 700 459 HD  3482 000 246  1878 004 104  3151 000 493	430 10 MFZ430 430WGTZ KZISZ-5	Getr. / GBox: ZF AS-Tronic 24X,35X,42X,45X,70X für Ausrückgabel mit Rollen / for release fork with rollers	(70)		
	09.07 -		 3151 000 144	KZISZ-5	Getr. / GBox: ZF AS-Tronic 24X,35X,42X,45X,70X für Ausrückgabel mit Nocken / for release fork with cams	(69)		
	12.07 -		 3400 700 327  3482 114 031  1878 004 832  3151 263 031	430 10 GMFZ430N 430WGTZ KZISZ-6	Getr. / GBox: ZF Ecosplit 3 24X,35X,42X,45X,70X für Fahrzeuge mit Nebenantrieb / for vehicles with PTO	(73)	(82)	
	12.07 -		 3488 017 447	400 MFZ2/400X	Getr. / GBox: ZF Ecosplit 3 24X,35X,42X,45X,70X für Fahrzeuge mit Zweischeibenkupplung / for vehicles with double disc clutch enthält eine Kupplungsscheibe / This part number includes one clutch disc	(77)	(66)	
	05.08 -		 1878 002 643	400 10 400WGTZ	Getr. / GBox: ZF Ecosplit 3 24X,35X,42X,45X,70X für Fahrzeuge mit Zweischeibenkupplung / for vehicles with double disc clutch	(77)		
	05.08 -		 3151 262 031	KZISZ-5	Getr. / GBox: ZF Ecosplit 3 24X,35X,42X,45X,70X für Fahrzeuge mit Zweischeibenkupplung / for vehicles with double disc clutch	(77)		
			 3496 006 000		24X,35X,42X,45X,70X langer Bügel / long handle		(86)	
			 1863 869 038		24X,35X,42X,45X,70X			
	24.540 FNLLW/N 45X 41.540 FVDS, FVDLS 87X 86X		02.09 -	D2676LF13, D2676LF06	 3400 700 460 HD  3482 000 246  1878 004 104  3151 000 034	430 10 MFZ430 430WGTZ KZISZ-5	Getr. / GBox: ZF Ecosplit 3 45X,86X,87X	
06.08 -		 3400 700 459 HD  3482 000 246  1878 004 104  3151 000 493	430 10 MFZ430 430WGTZ KZISZ-5		Getr. / GBox: ZF AS-Tronic 45X,86X,87X für Ausrückgabel mit Rollen / for release fork with rollers	(70)		
		 3151 000 144	KZISZ-5		Getr. / GBox: ZF AS-Tronic 45X,86X,87X für Ausrückgabel mit Nocken / for release fork with cams	(69)		
		 3400 700 327  3482 114 031  1878 004 832  3151 263 031	430 10 GMFZ430N 430WGTZ KZISZ-6		Getr. / GBox: ZF Ecosplit 3 45X,86X,87X für Fahrzeuge mit Nebenantrieb / for vehicles with PTO	(73)	(82)	
		 3488 017 447	400 MFZ2/400X		Getr. / GBox: ZF Ecosplit 3 45X,86X,87X für Fahrzeuge mit Zweischeibenkupplung / for vehicles with double disc clutch enthält eine Kupplungsscheibe / This part number includes one clutch disc	(77)	(66)	
		 1878 002 643	400 10 400WGTZ		Getr. / GBox: ZF Ecosplit 3 45X,86X,87X für Fahrzeuge mit Zweischeibenkupplung / for vehicles with double disc clutch	(77)		
		 3151 262 031	KZISZ-5		Getr. / GBox: ZF Ecosplit 3 45X,86X,87X für Fahrzeuge mit Zweischeibenkupplung / for vehicles with double disc clutch	(77)		
		 3496 006 000			45X,86X,87X langer Bügel / long handle		(86)	
		 1863 869 038			45X,86X,87X			

		CODE				
--	--	------	--	---	---	---





































MAN

TGX		09.07 -				
26.320 FNLS, FNLLS 18X 21X 26.360 FDC, FDLC, FDRC, FDLRC 26X 30X 26.360 FDS, FDLS, FDRS, FDLRS 26X 30X 26.360 FNLC, FNLCR, FNLLC, FNLLRC, FNLLW 21X 18X 26.400 FDS, FDLS, FDRS, FDLRS 26X 30X 26.400 FDC, FDLC, FDRC, FDLRC 26X 30X 26.400 FNLC, FNLCR, FNLLC, FNLLRC, FNLLW 21X 18X 33.360 FDC, FDC/M, FDLC 26X 30X 33.360 FDS, FDS/M, FDLS, FDLRS/M 30X 26X 33.400 FDC, FDC/M, FDLC 26X 30X 33.400 FDS, FDS/M, FDLS, FDLRS/M 30X 26X	10.07- 07.08- 07.08- 10.07- 07.08- 07.08- 10.07- 10.07- 10.07- 10.07-	D2066LF42, D2066LF37, D2066LF28, D2066LF43, D2066LF27, D2066LF41, D2066LF26, D2066LF61, D2066LF67, D2066LF38	 3400 700 380 ⊗ 3482 000 361 ⊗ 1878 080 037 ⊙ 3151 000 034	430 10 MFZ430 430WGTZ KZISZ-5	Getr. / GBox: ZF Ecosplit 3 18X,21X,26X,30X	
	 3400 700 381 ⊗ 3482 000 361 ⊗ 1878 080 037 ⊙ 3151 000 493		430 10 MFZ430 430WGTZ KZISZ-5	Getr. / GBox: ZF AS-Tronic 18X,21X,26X,30X für Ausrückgabel mit Rollen / for release fork with rollers	(70)	
	 3400 700 403 ⊗ 3482 000 361 ⊗ 1878 004 832 ⊙ 3151 000 144		430 10 MFZ430 430WGTZ KZISZ-5	Getr. / GBox: ZF AS-Tronic 18X,21X,26X,30X für Ausrückgabel mit Nocken / for release fork with cams	(69)	
	 3400 700 327 ⊗ 3482 114 031 ⊗ 1878 004 832 ⊙ 3151 263 031		430 10 GMFZ430N 430WGTZ KZISZ-6	Getr. / GBox: ZF Ecosplit 3 18X,21X,26X,30X für Fahrzeuge mit Nebenantrieb / for vehicles with PTO	(73)	
	 3488 017 447		400 MFZ2/400X	Getr. / GBox: ZF Ecosplit 3 18X,21X,26X,30X für Fahrzeuge mit Zweischeibenkupplung / for vehicles with double disc clutch	(77)	
				enthält eine Kupplungsscheibe / This part number includes one clutch disc	(66)	
	 1878 002 643		400 10 400WGTZ	Getr. / GBox: ZF Ecosplit 3 18X,21X,26X,30X für Fahrzeuge mit Zweischeibenkupplung / for vehicles with double disc clutch	(77)	
	 3151 262 031		KZISZ-5	Getr. / GBox: ZF Ecosplit 3 18X,21X,26X,30X für Fahrzeuge mit Zweischeibenkupplung / for vehicles with double disc clutch	(77)	
	 3496 006 000			18X,21X,26X,30X langer Bügel / long handle	(86)	
	 1863 869 038			18X,21X,26X,30X		
26.360 FNLS, FNLLS, FNLRs, FNLLRS, FPLS, FPLRS, FVLS 21X 24X 18X 26.400 FNLS, FNLLS, FNLRs, FNLLRS, FPLS, FPLRS, FVLS 18X 24X 21X	10.07- 10.07-	D2066LF27, D2066LF42, D2066LF37, D2066LF41, D2066LF26, D2066LF52, D2066LF61, D2066LF67, D2066LF38	 3400 700 380 ⊗ 3482 000 361 ⊗ 1878 080 037 ⊙ 3151 000 034	430 10 MFZ430 430WGTZ KZISZ-5	Getr. / GBox: ZF Ecosplit 3 18X,21X,24X	
	 3400 700 381 ⊗ 3482 000 361 ⊗ 1878 080 037 ⊙ 3151 000 493		430 10 MFZ430 430WGTZ KZISZ-5	Getr. / GBox: ZF AS-Tronic 18X,21X,24X für Ausrückgabel mit Rollen / for release fork with rollers	(70)	
	 3400 700 403 ⊗ 3482 000 361 ⊗ 1878 004 832 ⊙ 3151 000 144		430 10 MFZ430 430WGTZ KZISZ-5	Getr. / GBox: ZF AS-Tronic 18X,21X,24X für Ausrückgabel mit Nocken / for release fork with cams	(69)	
	 3400 700 327 ⊗ 3482 114 031 ⊗ 1878 004 832 ⊙ 3151 263 031		430 10 GMFZ430N 430WGTZ KZISZ-6	Getr. / GBox: ZF Ecosplit 3 18X,21X,24X für Fahrzeuge mit Nebenantrieb / for vehicles with PTO	(73)	
	 3488 017 447		400 MFZ2/400X	Getr. / GBox: ZF Ecosplit 3 18X,21X,24X für Fahrzeuge mit Zweischeibenkupplung / for vehicles with double disc clutch	(77)	
				enthält eine Kupplungsscheibe / This part number includes one clutch disc	(66)	
	 1878 002 643		400 10 400WGTZ	Getr. / GBox: ZF Ecosplit 3 18X,21X,24X für Fahrzeuge mit Zweischeibenkupplung / for vehicles with double disc clutch	(77)	
	 3151 262 031		KZISZ-5	Getr. / GBox: ZF Ecosplit 3 18X,21X,24X für Fahrzeuge mit Zweischeibenkupplung / for vehicles with double disc clutch	(77)	
	 3496 006 000			18X,21X,24X langer Bügel / long handle	(86)	
	 1863 869 038			18X,21X,24X		

TGX		09.07 -						
26.440 FDC, FDL, FDRC, FDLRC 26X 30X 26.440 FDS, FDLS, FDRS, FDLRS 30X 26X 28.440 FNLC 89X 28.440 FNLS 89X 33.440 FDC, FDC/M, FDL 26X 30X 33.440 FDS, FDS/M, FDLS, FDLS/M 26X 30X	07.08-	D2066LF25, D2066LF36, D2066LF40		3400 700 402 ● 3482 000 246 ● 1878 002 139 ● 3151 000 034	430 10 MFZ430 430WGTZ KZISZ-5	Getr. / GBox: ZF Ecosplit 3 26X,30X,89X		
	07.08-			3400 700 460 HD ● 3482 000 246 ● 1878 004 104 ● 3151 000 034	430 10 MFZ430 430WGTZ KZISZ-5	Getr. / GBox: ZF Ecosplit 3 26X,30X,89X		
	10.07-			3400 700 381 ● 3482 000 361 ● 1878 080 037 ● 3151 000 493	430 10 MFZ430 430WGTZ KZISZ-5	Getr. / GBox: ZF AS-Tronic 26X,30X,89X für Ausrückgabel mit Rollen / for release fork with rollers	(70)	
	10.07-			3400 700 403 ● 3482 000 361 ● 1878 004 832 ● 3151 000 144	430 10 MFZ430 430WGTZ KZISZ-5	Getr. / GBox: ZF AS-Tronic 26X,30X,89X für Ausrückgabel mit Nocken / for release fork with cams	(69)	
	10.07-			3400 700 327 ● 3482 114 031 ● 1878 004 832 ● 3151 263 031	430 10 GMFZ430N 430WGTZ KZISZ-6	Getr. / GBox: ZF Ecosplit 3 26X,30X,89X für Fahrzeuge mit Nebenantrieb / for vehicles with PTO	(73)	
					3488 017 447	400 MFZ2/400X	Getr. / GBox: ZF Ecosplit 3 26X,30X,89X für Fahrzeuge mit Zweischeibenkupplung / for vehicles with double disc clutch enthält eine Kupplungsscheibe / This part number includes one clutch disc	(77) (66)
					1878 002 643	400 10 400WGTZ	Getr. / GBox: ZF Ecosplit 3 26X,30X,89X für Fahrzeuge mit Zweischeibenkupplung / for vehicles with double disc clutch	(77)
					3151 262 031	KZISZ-5	Getr. / GBox: ZF Ecosplit 3 26X,30X,89X für Fahrzeuge mit Zweischeibenkupplung / for vehicles with double disc clutch	(77)
					3496 006 000		26X,30X,89X langer Bügel / long handle	(86)
					1863 869 038		26X,30X,89X	
26.440 FNLC, FNLC, FNLLC, FNLLRC, FNLLW 22X 21X 18X 26.440 FNLS, FNLLS, FNLRs, FNLLRS, FPLS, FPLRS, FVLS 22X 18X 24X	10.07-	D2066LF25, D2066LF36, D2066LF40		3400 700 402 ● 3482 000 246 ● 1878 002 139 ● 3151 000 034	430 10 MFZ430 430WGTZ KZISZ-5	Getr. / GBox: ZF Ecosplit 3 18X,21X,24X		
	10.07-			3400 700 460 HD ● 3482 000 246 ● 1878 004 104 ● 3151 000 034	430 10 MFZ430 430WGTZ KZISZ-5	Getr. / GBox: ZF Ecosplit 3 18X,21X,24X		
				3400 700 381 ● 3482 000 361 ● 1878 080 037 ● 3151 000 493	430 10 MFZ430 430WGTZ KZISZ-5	Getr. / GBox: ZF AS-Tronic 18X,21X,24X für Ausrückgabel mit Rollen / for release fork with rollers	(70)	
				3400 700 403 ● 3482 000 361 ● 1878 004 832 ● 3151 000 144	430 10 MFZ430 430WGTZ KZISZ-5	Getr. / GBox: ZF AS-Tronic 18X,21X,24X für Ausrückgabel mit Nocken / for release fork with cams	(69)	
				3400 700 327 ● 3482 114 031 ● 1878 004 832 ● 3151 263 031	430 10 GMFZ430N 430WGTZ KZISZ-6	Getr. / GBox: ZF Ecosplit 3 18X,21X,24X für Fahrzeuge mit Nebenantrieb / for vehicles with PTO	(73)	
					3488 017 447	400 MFZ2/400X	Getr. / GBox: ZF Ecosplit 3 18X,21X,24X für Fahrzeuge mit Zweischeibenkupplung / for vehicles with double disc clutch enthält eine Kupplungsscheibe / This part number includes one clutch disc	(77) (66)
					1878 002 643	400 10 400WGTZ	Getr. / GBox: ZF Ecosplit 3 18X,21X,24X für Fahrzeuge mit Zweischeibenkupplung / for vehicles with double disc clutch	(77)
					3151 262 031	KZISZ-5	Getr. / GBox: ZF Ecosplit 3 18X,21X,24X für Fahrzeuge mit Zweischeibenkupplung / for vehicles with double disc clutch	(77)
					3496 006 000		18X,21X,24X langer Bügel / long handle	(86)
					1863 869 038		18X,21X,24X	







































		CODE				
--	--	------	--	---	---	---

MAN

TGX		09.07 -					
26.480 FDC, FDL, FDRC, FDLRC 26X 30X 26.480 FDS, FDLS, FDRS, FDLRS 30X 26X 26.540 FDC, FDL, FDRC, FDLRC 30X 26X 26.540 FDS, FDLS, FDRS, FDLRS 26X 30X 33.480 FDC, FDC/M, FDL, FDLRC 26X 30X 33.480 FDS, FDS/M, FDLS, FDLRS/M 30X 26X 33.540 FDC, FDC/M, FDL, FDLRC 30X 26X 33.540 FDS, FDS/M, FDLS, FDLRS/M 26X 30X	07.08-	D2676LF16, D2676LF07, D2676LF14, D2676LF13, D2676LF06, D2676LF05, D2676LF25	 3400 700 460 HD  3482 000 246  1878 004 104  3151 000 034	430 10 MFZ430 430WGTZ KZISZ-5	Getr. / GBox: ZF Ecosplit 3 26X,30X		
	07.08-		 3400 700 459 HD  3482 000 246  1878 004 104  3151 000 493	430 10 MFZ430 430WGTZ KZISZ-5	Getr. / GBox: ZF AS-Tronic 26X,30X für Ausrückgabel mit Rollen / for release fork with rollers	(70)	
	02.09-		 3151 000 144	KZISZ-5	Getr. / GBox: ZF AS-Tronic 26X,30X für Ausrückgabel mit Nocken / for release fork with cams	(69)	
	02.09-		 3400 700 327  3482 114 031  1878 004 832  3151 263 031	430 10 GMFZ430N 430WGTZ KZISZ-6	Getr. / GBox: ZF Ecosplit 3 26X,30X für Fahrzeuge mit Nebenantrieb / for vehicles with PTO	(73)	
	10.07-		 3488 017 447	400 MFZ2/400X	Getr. / GBox: ZF Ecosplit 3 26X,30X für Fahrzeuge mit Zweischeibenkupplung / for vehicles with double disc clutch	(77)	
	10.07-		 1878 002 643	400 10 400WGTZ	Getr. / GBox: ZF Ecosplit 3 26X,30X für Fahrzeuge mit Zweischeibenkupplung / for vehicles with double disc clutch	(77)	
	10.07-		 3151 262 031	KZISZ-5	Getr. / GBox: ZF Ecosplit 3 26X,30X für Fahrzeuge mit Zweischeibenkupplung / for vehicles with double disc clutch	(77)	
			 3496 006 000		26X,30X langer Bügel / long handle	(86)	
			 1863 869 038		26X,30X		
	26.480 FNLC, FNLCR, FNLLC, FNLLRC, FNLLW 18X 21X 26.480 FNLS, FNLLS, FNLR, FNLLRS, FNLLRS, FPLS, FPLRS, FVLS 18X 21X 24X 26.540 FNLC, FNLCR, FNLLC, FNLLRC, FNLLW 21X 18X 26.540 FNLS, FNLR, FNLLS, FNLLRS, FPLS, FPLRS, FVLS 18X 24X 21X		10.07-	D2676LF07, D2676LF14, D2676LF13, D2676LF06, D2676LF05, D2676LF25, D2676LF21	 3400 700 460 HD  3482 000 246  1878 004 104  3151 000 034	430 10 MFZ430 430WGTZ KZISZ-5	Getr. / GBox: ZF Ecosplit 3 18X,21X,24X
10.07-		 3400 700 459 HD  3482 000 246  1878 004 104  3151 000 493	430 10 MFZ430 430WGTZ KZISZ-5		Getr. / GBox: ZF AS-Tronic 18X,21X,24X für Ausrückgabel mit Rollen / for release fork with rollers	(70)	
10.07-		 3151 000 144	KZISZ-5		Getr. / GBox: ZF AS-Tronic 18X,21X,24X für Ausrückgabel mit Nocken / for release fork with cams	(69)	
10.07-		 3400 700 327  3482 114 031  1878 004 832  3151 263 031	430 10 GMFZ430N 430WGTZ KZISZ-6		Getr. / GBox: ZF Ecosplit 3 18X,21X,24X für Fahrzeuge mit Nebenantrieb / for vehicles with PTO	(73)	
		 3488 017 447	400 MFZ2/400X		Getr. / GBox: ZF Ecosplit 3 18X,21X,24X für Fahrzeuge mit Zweischeibenkupplung / for vehicles with double disc clutch	(77)	
		 1878 002 643	400 10 400WGTZ		Getr. / GBox: ZF Ecosplit 3 18X,21X,24X für Fahrzeuge mit Zweischeibenkupplung / for vehicles with double disc clutch	(77)	
		 3151 262 031	KZISZ-5		Getr. / GBox: ZF Ecosplit 3 18X,21X,24X für Fahrzeuge mit Zweischeibenkupplung / for vehicles with double disc clutch	(77)	
		 3496 006 000			18X,21X,24X langer Bügel / long handle	(86)	
		 1863 869 038			18X,21X,24X		























		CODE				
--	--	------	--	---	---	---

MAN









TGX		09.07 -					
28.360 FNLC 89X 28.360 FNLS 89X 28.400 FNLC 89X 28.400 FNLS 89X	10.07 -	D2066LF27, D2066LF42, D2066LF37, D2066LF41, D2066LF26, D2066LF61, D2066LF38	 3400 700 380  3482 000 361  1878 080 037  3151 000 034	430 10 MFZ430 430WGTZ KZISZ-5	Getr. / GBox: ZF Ecosplit 3 89X		
	10.07 -		 3400 700 381  3482 000 361  1878 080 037  3151 000 493	430 10 MFZ430 430WGTZ KZISZ-5	Getr. / GBox: ZF AS-Tronic 89X für Ausrückgabel mit Rollen / for release fork with rollers	(70)	
	10.07 -		 3400 700 403  3482 000 361  1878 004 832  3151 000 144	430 10 MFZ430 430WGTZ KZISZ-5	Getr. / GBox: ZF AS-Tronic 89X für Ausrückgabel mit Nocken / for release fork with cams	(69)	
	10.07 -		 3400 700 327  3482 114 031  1878 004 832  3151 263 031	430 10 GMFZ430N 430WGTZ KZISZ-6	Getr. / GBox: ZF Ecosplit 3 89X für Fahrzeuge mit Nebenantrieb / for vehicles with PTO für Nebenantrieb / for PTO	(73)	(82)
			 3488 017 447	400 MFZ2/400X	Getr. / GBox: ZF Ecosplit 3 89X für Fahrzeuge mit Zweischeibenkupplung / for vehicles with double disc clutch enthält eine Kupplungsscheibe / This part number includes one clutch disc	(77)	(66)
			 1878 002 643	400 10 400WGTZ	Getr. / GBox: ZF Ecosplit 3 89X für Fahrzeuge mit Zweischeibenkupplung / for vehicles with double disc clutch	(77)	
			 3151 262 031	KZISZ-5	Getr. / GBox: ZF Ecosplit 3 89X für Fahrzeuge mit Zweischeibenkupplung / for vehicles with double disc clutch	(77)	
			 3496 006 000		89X langer Bügel / long handle		(86)
			 1863 869 038		89X		
28.480 FNLC 89X 28.480 FNLS 89X 28.540 FNLC 89X 28.540 FNLS 89X	10.07 -	D2676LF14, D2676LF07, D2676LF13, D2676LF06, D2676LF05, D2676LF25	 3400 700 460 HD  3482 000 246  1878 004 104  3151 000 034	430 10 MFZ430 430WGTZ KZISZ-5	Getr. / GBox: ZF Ecosplit 3 89X		
	10.07 -		 3400 700 459 HD  3482 000 246  1878 004 104  3151 000 493	430 10 MFZ430 430WGTZ KZISZ-5	Getr. / GBox: ZF AS-Tronic 89X für Ausrückgabel mit Rollen / for release fork with rollers	(70)	
	10.07 -		 3151 000 144	KZISZ-5	Getr. / GBox: ZF AS-Tronic 89X für Ausrückgabel mit Nocken / for release fork with cams	(69)	
	02.09 -		 3400 700 327  3482 114 031  1878 004 832  3151 263 031	430 10 GMFZ430N 430WGTZ KZISZ-6	Getr. / GBox: ZF Ecosplit 3 89X für Fahrzeuge mit Nebenantrieb / for vehicles with PTO für Nebenantrieb / for PTO	(73)	(82)
			 3488 017 447	400 MFZ2/400X	Getr. / GBox: ZF Ecosplit 3 89X für Fahrzeuge mit Zweischeibenkupplung / for vehicles with double disc clutch enthält eine Kupplungsscheibe / This part number includes one clutch disc	(77)	(66)
			 1878 002 643	400 10 400WGTZ	Getr. / GBox: ZF Ecosplit 3 89X für Fahrzeuge mit Zweischeibenkupplung / for vehicles with double disc clutch	(77)	
			 3151 262 031	KZISZ-5	Getr. / GBox: ZF Ecosplit 3 89X für Fahrzeuge mit Zweischeibenkupplung / for vehicles with double disc clutch	(77)	
			 3496 006 000		89X langer Bügel / long handle		(86)
			 1863 869 038		89X		

		CODE				
--	--	------	--	---	---	---



MAN

TGX		09.07 -				
35.360 FDNLC 92X 35.400 FDNLC 92X	06.08-	D2066LF37, D2066LF27, D2066LF42, D2066LF41, D2066LF26, D2066LF38	 3400 700 380 ⊗ 3482 000 361 ⊗ 1878 080 037 ⊙ 3151 000 034	430 10 MFZ430 430WGTZ KZISZ-5	Getr. / GBox: ZF Ecosplit 3 92X	
	06.08-		 3400 700 381 ⊗ 3482 000 361 ⊗ 1878 080 037 ⊙ 3151 000 493	430 10 MFZ430 430WGTZ KZISZ-5	Getr. / GBox: ZF AS-Tronic 92X für Ausrückgabel mit Rollen / for release fork with rollers	(70)
			 3400 700 403 ⊗ 3482 000 361 ⊗ 1878 004 832 ⊙ 3151 000 144	430 10 MFZ430 430WGTZ KZISZ-5	Getr. / GBox: ZF AS-Tronic 92X für Ausrückgabel mit Nocken / for release fork with cams	(69)
			 3400 700 327 ⊗ 3482 114 031 ⊗ 1878 004 832 ⊙ 3151 263 031	430 10 GMFZ430N 430WGTZ KZIZ-6	Getr. / GBox: ZF Ecosplit 3 92X für Fahrzeuge mit Nebenantrieb / for vehicles with PTO	(73)
			 3488 017 447	400 MFZ2/400X	Getr. / GBox: ZF Ecosplit 3 92X für Fahrzeuge mit Zweischeibenkupplung / for vehicles with double disc clutch	(77)
			 1878 002 643	400 10 400WGTZ	enthält eine Kupplungsscheibe / This part number includes one clutch disc	(66)
			 1878 002 643	400 10 400WGTZ	Getr. / GBox: ZF Ecosplit 3 92X für Fahrzeuge mit Zweischeibenkupplung / for vehicles with double disc clutch	(77)
			 3151 262 031	KZISZ-5	Getr. / GBox: ZF Ecosplit 3 92X für Fahrzeuge mit Zweischeibenkupplung / for vehicles with double disc clutch	(77)
			 3496 006 000		92X langer Bügel / long handle	(86)
 1863 869 038		92X				
35.440 FDNLC 92X	06.08-	D2066LF25, D2066LF36, D2066LF40	 3400 700 402 ⊗ 3482 000 246 ⊗ 1878 002 139 ⊙ 3151 000 034	430 10 MFZ430 430WGTZ KZISZ-5	Getr. / GBox: ZF Ecosplit 3 92X	
			 3400 700 460 HD ⊗ 3482 000 246 ⊗ 1878 004 104 ⊙ 3151 000 034	430 10 MFZ430 430WGTZ KZISZ-5	Getr. / GBox: ZF Ecosplit 3 92X	
			 3400 700 381 ⊗ 3482 000 361 ⊗ 1878 080 037 ⊙ 3151 000 493	430 10 MFZ430 430WGTZ KZISZ-5	Getr. / GBox: ZF AS-Tronic 92X für Ausrückgabel mit Rollen / for release fork with rollers	(70)
			 3400 700 403 ⊗ 3482 000 361 ⊗ 1878 004 832 ⊙ 3151 000 144	430 10 MFZ430 430WGTZ KZISZ-5	Getr. / GBox: ZF AS-Tronic 92X für Ausrückgabel mit Nocken / for release fork with cams	(69)
			 3400 700 327 ⊗ 3482 114 031 ⊗ 1878 004 832 ⊙ 3151 263 031	430 10 GMFZ430N 430WGTZ KZIZ-6	Getr. / GBox: ZF Ecosplit 3 92X für Fahrzeuge mit Nebenantrieb / for vehicles with PTO	(73)
			 3488 017 447	400 MFZ2/400X	für Nebenantrieb / for PTO	(82)
			 3488 017 447	400 MFZ2/400X	Getr. / GBox: ZF Ecosplit 3 92X für Fahrzeuge mit Zweischeibenkupplung / for vehicles with double disc clutch	(77)
			 1878 002 643	400 10 400WGTZ	enthält eine Kupplungsscheibe / This part number includes one clutch disc	(66)
			 1878 002 643	400 10 400WGTZ	Getr. / GBox: ZF Ecosplit 3 92X für Fahrzeuge mit Zweischeibenkupplung / for vehicles with double disc clutch	(77)
			 3151 262 031	KZISZ-5	Getr. / GBox: ZF Ecosplit 3 92X für Fahrzeuge mit Zweischeibenkupplung / for vehicles with double disc clutch	(77)
 3496 006 000		92X langer Bügel / long handle	(86)			
 1863 869 038		92X				





TGX 09.07 -

35.480 FDNLC 92X 35.540 FDNLC 92X	06.08-	D2676LF14, D2676LF07, D2676LF13, D2676LF06, D2676LF05		3400 700 460 HD ⊗ 3482 000 246 ⊗ 1878 004 104 ⊙ 3151 000 034	430 10 MFZ430 430WGTZ KZISZ-5	Getr. / GBox: ZF Ecosplit 3 92X		
	06.08-				3400 700 459 HD ⊗ 3482 000 246 ⊗ 1878 004 104 ⊙ 3151 000 493	430 10 MFZ430 430WGTZ KZISZ-5	Getr. / GBox: ZF AS-Tronic 92X für Ausrückgabel mit Rollen / for release fork with rollers	(70)
					3151 000 144	KZISZ-5	Getr. / GBox: ZF AS-Tronic 92X für Ausrückgabel mit Nocken / for release fork with cams	(69)
					3400 700 327 ⊗ 3482 114 031 ⊗ 1878 004 832 ⊙ 3151 263 031	430 10 GMFZ430N 430WGTZ KZISZ-6	Getr. / GBox: ZF Ecosplit 3 92X für Fahrzeuge mit Nebenantrieb / for vehicles with PTO für Nebenantrieb / for PTO	(73) (82)
					3488 017 447	400 MFZ2/400X	Getr. / GBox: ZF Ecosplit 3 92X für Fahrzeuge mit Zweischeibenkupplung / for vehicles with double disc clutch enthält eine Kupplungsscheibe / This part number includes one clutch disc	(77) (66)
					1878 002 643	400 10 400WGTZ	Getr. / GBox: ZF Ecosplit 3 92X für Fahrzeuge mit Zweischeibenkupplung / for vehicles with double disc clutch	(77)
					3151 262 031	KZISZ-5	Getr. / GBox: ZF Ecosplit 3 92X für Fahrzeuge mit Zweischeibenkupplung / for vehicles with double disc clutch	(77)
					3496 006 000		92X langer Bügel / long handle	(86)
					1863 869 038		92X	











6 ...

6.115 H				1880 083 132 #	280 G280		
				1863 100 030	GR-3	mit Anlauftring / with thrust ring	(88)
6.126 H				1863 100 030	GR-3	mit Anlauftring / with thrust ring	(88)

7 ...





























7.126 H				1880 083 132 #	280 G280		
				1863 100 030	GR-3	mit Anlauftring / with thrust ring	(88)
				1863 100 030	GR-3	mit Anlauftring / with thrust ring	(88)
7.136 H				1863 100 030	GR-3	mit Anlauftring / with thrust ring	(88)



























8 ...

8.126 H				1863 100 030	GR-3	mit Anlauftring / with thrust ring	(88)
8.156 F 8.160 F 8.186 FW				1882 110 532 #	350 GF350		
				1878 005 367	350 10 350WGTZ		
				3151 000 395	KZIS-4		
8.156 H				1880 083 132 #	280 G280		
				3151 199 001	KZIS-3		
8.192				1882 209 335 #	350 GF350		
				1878 001 144	350 10 350WGTZ		
				1878 001 147 #	350 10 350WGTZ		
				3151 000 958	KZIS-4		

		CODE		 Parameter		
--	--	------	--	---	---	---































MAN

9 ...						
9.126 H				1863 100 030	GR-3	mit Anlaufring / with thrust ring (88)
9.156 H,F 9.168 FL 9.186 F,H,HKA 9.192 FL				1882 110 532 #	350 GF350	
				1878 005 367	350 10 350WGTZ	
				3151 000 395	KZIS-4	
9.160 HAK				1882 110 532 #	350 GF350	
				1878 005 367	350 10 350WGTZ	
9.192 HA				3482 002 234	350 GMF350X	
				1878 001 144	350 10 350WGTZ	
				1878 001 147 #	350 10 350WGTZ	
				3151 000 958	KZIS-4	
10 ...						
10.126 H,HA 10.136 H,HA				1863 100 030	GR-3	mit Anlaufring / with thrust ring (88)
10.150 10.152	01.87 - 12.91 01.87 - 12.92	D0826OH		3400 125 501 3482 060 132 1878 001 077 3151 199 001	350 10 MF350 350GTZ KZIS-3	
10.210		D2146MT		3482 002 234	350 GMF350X	
				1878 001 144	350 10 350WGTZ	
				1878 001 147 #	350 10 350WGTZ	
				3151 000 958	KZIS-4	
10.212 10.215 10.230 FL	12.65 -			3151 000 395	KZIS-4	
10.212	- 11.65			1861 470 234	380 10 380GSZ	
				3151 000 395	KZIS-4	
11 ...						
11.136 H,HA,HK,HS,HAK				1863 100 030	GR-3	mit Anlaufring / with thrust ring (88)
11.136 U 900		D0216MXUL		3151 199 001	KZIS-3	
11.168		D2555M		3482 002 234	350 GMF350X	
				1878 001 144	350 10 350WGTZ	
				1878 001 147 #	350 10 350WGTZ	
				3151 000 958	KZIS-4	
11.190 752 11.220 752 11.230 752		D0826LOH		3482 060 132	350 MF350	
				1878 001 145	350 10 350WGTZ	
				3151 199 001	KZIS-3	
11.192 HA				1882 209 335 #	350 GF350	
				1878 001 144	350 10 350WGTZ	
				1878 001 147 #	350 10 350WGTZ	
				3151 000 958	KZIS-4	

13 ...						
13.136 H,HA			 1863 100 030	GR-3	mit Anlauftring / with thrust ring	(88)
13.136 U 900		D0216MXUL	 3151 199 001	KZIS-3		
13.168		D2555M, MF, MXF	 3482 002 234 HD	350 GMF350X		
			 1878 001 144	350 10 350WGTZ		
			1878 001 147 #	350 10 350WGTZ		
			 3151 000 958	KZIS-4		
		D2565MF	 1882 209 335 #	350 GF350		
			 1878 001 144	350 10 350WGTZ		
			1878 001 147 #	350 10 350WGTZ		
			 3151 000 958	KZIS-4		
		D2855BYUL	 1882 325 134	380 G380		
			 1861 470 234	380 10 380GSZ		
		D2538M	 1882 302 131 HD	380 GF380		
			 1878 001 152 HD	380 10 380WGTZ		
 3151 000 395 HD	KZIS-4					
13.192		D2555, D2565M	 1882 209 335 #	350 GF350		
			3482 002 234 HD	350 GMF350X		
			 1878 001 144	350 10 350WGTZ		
			1878 001 147 #	350 10 350WGTZ		
			 3151 000 958	KZIS-4		
13.192 F,H,HA			 1882 110 532 #	350 GF350		
			 1878 005 367	350 10 350WGTZ		
			 3151 000 395	KZIS-4		
13.192 U,UL 903		D2555	 1882 209 335 #	350 GF350		
			 1878 001 144	350 10 350WGTZ		
			1878 001 147 #	350 10 350WGTZ		
			 3151 000 958	KZIS-4		
13.212 13.215 H,F 13.230 H,F			 3151 000 395	KZIS-4		
13.250 F 13.256 F 13.275 F 13.304 F			 3482 124 541	430 GMF430		
			1882 330 032 ●#	420 GF420		
			 1878 001 155 ▲#	420 10 420WGTZ		
			 3151 000 395	KZIS-4		
13.304 DFR RT9509			 3482 124 541	430 GMF430		
			1882 330 032 ●#	420 GF420		









		CODE				
--	--	------	--	---	---	---













MAN

14 ...							
14.136		D0226MF	 3482 008 110	310 MF310			
			 1861 577 037 #	310 10 310GTD			
			 3151 199 001	KZIS-3			
14.168		D2555MF, MXF	 3482 002 234	350 GMF350X			
			 1878 001 144	350 10 350WGTZ			
			 1878 001 147 #	350 10 350WGTZ			
			 3151 000 958	KZIS-4			
		D2565MF	 1882 209 335 #	350 GF350			
			 1878 001 144	350 10 350WGTZ			
			 1878 001 147 #	350 10 350WGTZ			
14.170		D0226MKF	 3482 060 233	350 MF350	Getr. / GBox: ZF-S6-36		
			 1861 777 037	350 10 350GTD	Getr. / GBox: ZF-S6-36		
			 3151 199 001	KZIS-3	Getr. / GBox: ZF-S6-36		
			 3482 017 033	380 GMF380	Getr. / GBox: ZF-S6-65		
			 1878 001 152	380 10 380WGTZ	Getr. / GBox: ZF-S6-65		
			 3151 000 395	KZIS-4	Getr. / GBox: ZF-S6-65		
14.192 903		D2555, D2565M	 1882 209 335 #	350 GF350			
			 3482 002 234 HD	350 GMF350X			
			 1878 001 144	350 10 350WGTZ			
			 1878 001 147 #	350 10 350WGTZ			
			 3151 000 958	KZIS-4			
14.192		D0826MKF	 3482 017 033	380 GMF380			
			 1878 001 152	380 10 380WGTZ			
			 3151 000 395	KZIS-4			
14.192 F,H		D2555	 1882 209 335 #	350 GF350			
			 1878 001 144	350 10 350WGTZ			
			 1878 001 147 #	350 10 350WGTZ			
			 3151 000 958	KZIS-4			
14.200		D2538M	 1882 302 131	380 GF380			
			 1878 001 152	380 10 380WGTZ			
			 3151 000 395	KZIS-4			

		CODE				
--	--	------	--	---	---	---





























MAN

14 ...							
14.220 526	01.83-	D2566MF		1882 302 131	380 GF380	Je nach Kundenwunsch mit unterschiedlicher Kupplung / Equipped with different clutch according to customer requirement	(33)
				1878 001 152	380 10 380WGTZ		
				3482 124 534	430 GMF430	Je nach Kundenwunsch mit unterschiedlicher Kupplung / Equipped with different clutch according to customer requirement	(33)
				1882 301 239 ●	420 GF420	Je nach Kundenwunsch mit unterschiedlicher Kupplung / Equipped with different clutch according to customer requirement	(33)
				1878 003 657	420 10 420WGTZ		
				3151 000 395	KZIS-4		
14.220				1878 000 964	380 10 380GTZ	für Nebenantrieb / for PTO	(82)
14.285 DFR RT9509				3482 124 541	430 GMF430		
				1882 330 032 ●#	420 GF420		

15 ...							
15.136 H,HA				1863 100 030	GR-3	mit Anlauftring / with thrust ring	(88)
15.168 15.192				1878 001 079	350 10 350GTZ	Nebenantriebs-ID / PTO ID: 80	(48)
15.168		D2568, D2555M, MF, MXF		3482 002 234	350 GMF350X		
				1878 001 144	350 10 350WGTZ		
				1878 001 147 #	350 10 350WGTZ		
				3151 000 958	KZIS-4		
		D2538M		1882 302 131 HD	380 GF380		
				1878 001 152 HD	380 10 380WGTZ		
	3151 000 395 HD		KZIS-4				
15.168 FM,HOC 15.192 F,H,HA				1882 110 532 #	350 GF350		
				1878 005 367	350 10 350WGTZ		
				3151 000 395	KZIS-4		

































		CODE				
--	--	------	--	---	---	---

MAN

15 ...						
15.192		D2238M	 1882 302 131	380 GF380		
			 1878 001 152	380 10 380WGTZ		
			 3151 000 395	KZIS-4		
		D2565M	 1882 209 335 #	350 GF350		
			3482 002 234 HD	350 GMF350X		
			 1878 001 144	350 10 350WGTZ		
			1878 001 147 #	350 10 350WGTZ		
		D2568	 3151 000 958	KZIS-4		
			 3482 002 234	350 GMF350X		
			 1878 001 144	350 10 350WGTZ		
			1878 001 147 #	350 10 350WGTZ		
		D2855BYUL	 3151 000 958	KZIS-4		
 1882 325 134	380 G380					
 1861 470 234	380 10 380GSZ					
15.200 15.216			 1882 302 131	380 GF380		
			 1878 001 152	380 10 380WGTZ		
			 3151 000 395	KZIS-4		
15.212 15.215 HD			 3151 000 395	KZIS-4		
15.220 526 15.240 526	01.83-	D2566MF	 1882 302 131	380 GF380	Je nach Kundenwunsch mit unterschiedlicher Kupplung / Equipped with different clutch according to customer requirement	(33)
			 1878 001 152	380 10 380WGTZ		
	 3482 124 534		430 GMF430	Je nach Kundenwunsch mit unterschiedlicher Kupplung / Equipped with different clutch according to customer requirement	(33)	
	 1882 301 239		420 GF420	Je nach Kundenwunsch mit unterschiedlicher Kupplung / Equipped with different clutch according to customer requirement	(33)	
	 1878 003 657		420 10 420WGTZ			
	 3151 000 395		KZIS-4			
15.220 15.240			 1878 000 964	380 10 380GTZ	für Nebenantrieb / for PTO	(82)
15.240		D2238M	 1882 302 131	380 GF380		
			 1878 001 152	380 10 380WGTZ		
			 3151 000 395	KZIS-4		
16 ...						
16.132 FKO			 1882 209 335 HD#	350 GF350		
			 1878 001 144 HD	350 10 350WGTZ		
			1878 001 147 HD#	350 10 350WGTZ		
			 3151 000 958 HD	KZIS-4		































		CODE				
--	--	------	--	---	---	---





































MAN

16 ...						
16.136		D0226MF	 3482 008 110	310 MF310		
			 1861 577 037 #	310 10 310GTD		
			 3151 199 001	KZIS-3		
16.168			 1878 001 079	350 10 350GTZ	Nebenantriebs-ID / PTO ID: 80	(48)
16.192						
16.168		D2555M, MF, MXF	 3482 002 234	350 GMF350X		
			 1878 001 144	350 10 350WGTZ		
			 1878 001 147 #	350 10 350WGTZ		
			 3151 000 958	KZIS-4		
16.168 FL 16.186 FN			 1882 110 532 #	350 GF350		
			 1878 005 367	350 10 350WGTZ		
			 3151 000 395	KZIS-4		
16.170		D0226MKF	 3482 060 233	350 MF350	Getr. / GBox: ZF-S6-36	
			 1861 777 037	350 10 350GTD	Getr. / GBox: ZF-S6-36	
			 3151 199 001	KZIS-3	Getr. / GBox: ZF-S6-36	
			 3482 017 033	380 GMF380	Getr. / GBox: ZF-S6-65	
			 1878 001 152	380 10 380WGTZ	Getr. / GBox: ZF-S6-65	
			 3151 000 395	KZIS-4	Getr. / GBox: ZF-S6-65	
16.192		D2565M	 1882 209 335 #	350 GF350		
			 3482 002 234 HD	350 GMF350X		
			 1878 001 144	350 10 350WGTZ		
			 1878 001 147 #	350 10 350WGTZ		
			 3151 000 958	KZIS-4		
		D0226MKF	 3482 017 033	380 GMF380		
			 1878 001 152	380 10 380WGTZ		
			 3151 000 395	KZIS-4		
16.200 16.220 527		D2566MF	 1882 302 131	380 GF380		
			 1878 001 152	380 10 380WGTZ		
			 3151 000 395	KZIS-4		
16.215 H,F 16.216 16.230 H,F,FL			 3151 000 395	KZIS-4		
16.232 16.240 520			 1882 302 131	380 GF380		
			 1878 001 152	380 10 380WGTZ		
			 3151 000 395	KZIS-4		

		CODE				
--	--	------	--	---	---	---



































MAN

16 ...						
16.240			 3482 124 534 HD	430 GMF430		
			 1882 301 239 HD ●	420 GF420		
			 1878 003 657 HD	420 10 420WGTZ		
			 3151 000 395 HD	KZIS-4	Getr. / GBox: ZF	
			 3151 067 032 HD	KZI4,5	Getr. / GBox: Fuller	
			 1878 000 964	380 10 380GTZ	für Nebenantrieb / for PTO	(82)
16.242	01.85 -	D2866F	 1882 017 131	420 GF420XN	Nebenantriebs-ID / PTO ID: 130E	(48)
			 1878 086 941	420 10 420WGTZ	Nebenantriebs-ID / PTO ID: 130E	(48)
16.250 FN 16.256 H 16.275 FN 16.304 FN,FVS			 3482 124 541	430 GMF430		
			 1882 330 032 ● #	420 GF420		
			 1878 001 155 ▲ #	420 10 420WGTZ		
			 3151 000 395	KZIS-4		
16.256		D2538M, MF	 1882 302 131	380 GF380		
			 1878 001 152	380 10 380WGTZ		
			 3151 000 395	KZIS-4		
		D2566MF	 3482 124 534	430 GMF430		
			 1882 301 239 ●	420 GF420		
			 1878 003 657	420 10 420WGTZ		
			 3151 000 395	KZIS-4	ZF-Getriebe / ZF Transmission	(59)
			 3151 067 032	KZI4,5	Fuller-Getriebe / Fuller Transmission	(22)
			 1861 526 046	420 10 420GSZ	Nebenantriebs-ID / PTO ID: 110	(48)
			 1882 017 131	420 GF420XN	Nebenantriebs-ID / PTO ID: 130E	(48)
16.262 16.272 16.322	01.85 - 12.92 01.90 - 01.90 -	D2865LF	 1878 086 941	420 10 420WGTZ	Nebenantriebs-ID / PTO ID: 130E	(48)
			 3482 124 534	430 GMF430		
16.280			 1882 301 239 ●	420 GF420		
			 1878 003 657	420 10 420WGTZ		
			 3151 067 032	KZI4,5	Fuller-Getriebe / Fuller Transmission	(22)
			 3151 000 395	KZIS-4	ZF-Getriebe / ZF Transmission	(59)
			 1882 346 131 #	420 GF420XN	Nebenantriebs-ID / PTO ID: 130	(48)
16.281 16.321		D2566MKF	 1861 876 134 #	420 10 420GVZ	Nebenantriebs-ID / PTO ID: 130	(48)

16 ...								
16.281 16.291 504 16.321 16.331 504 16.361 504		D2866	 1800 125 501 #  1882 342 134  1861 911 232  3151 067 032	420 10 GF420X 420WGVZ KZI4,5				
			 1888 015 346	380 GF2/380	Je nach Kundenwunsch mit unterschiedlicher Kupplung / Equipped with different clutch according to customer requirement enthält eine Kupplungsscheibe / This part number includes one clutch disc	(33) (66)		
			 1861 748 132 ▽	380 6 380GSZ	Lose Kupplungsscheibe / Loose clutch disc	(39)		
			 3151 000 395	KZIS-4				
			 1882 280 112	380 GF2/380	In 1888 enthalten / Contained in 1888	(29)		
			 1861 749 132 △	380 10 380WGSZ	In 1888 enthalten / Contained in 1888	(29)		
			 1859 212 001	380 GF2/380	In 1888 enthalten / Contained in 1888	(29)		
			16.292 16.302 16.332 16.372 16.422	01.85 - 12.92 01.90 - 12.92 01.85 - 12.92 01.90 - 01.90 -	D2866LF	 1882 017 131	420 GF420XN	Nebenantriebs-ID / PTO ID: 130E
 1878 086 941	420 10 420WGTZ	Nebenantriebs-ID / PTO ID: 130E				(48)		
 3482 124 534	430 GMF430							
 1882 301 239 ●	420 GF420							
16.320		D2538MT, D2530MF	 1878 003 657	420 10 420WGTZ				
			 3151 067 032	KZI4,5	Fuller-Getriebe / Fuller Transmission	(22)		
			 3151 000 395	KZIS-4	ZF-Getriebe / ZF Transmission	(59)		
			 1878 000 967 ▽	380 10 380GTZ	Lose Kupplungsscheibe / Loose clutch disc	(39)		
			 3151 000 395	KZIS-4				
			 1882 280 213	380 GF2/380	In 1888 enthalten / Contained in 1888	(29)		
16.320 U,UL 902,908,909,918			 1859 212 000	380 GF2/380	In 1888 enthalten / Contained in 1888	(29)		
			 1878 000 964 △	380 10 380GTZ	In 1888 enthalten / Contained in 1888	(29)		
			16.361	D2866	 1800 125 501 #  1882 342 134  1861 911 232  3151 067 032	420 10 GF420X 420WGVZ KZI4,5		
					 1882 346 131 #	420 GF420XN	Nebenantriebs-ID / PTO ID: 130	(48)
					 1861 876 134 #	420 10 420GVZ	Nebenantriebs-ID / PTO ID: 130	(48)
16.362	01.85 - 12.92	D2866KF, KU, LXF	 1882 017 131	420 GF420XN	Nebenantriebs-ID / PTO ID: 130E	(48)		
			 1878 086 941	420 10 420WGTZ	Nebenantriebs-ID / PTO ID: 130E	(48)		
16.462	01.85 -	D2840LF	 3400 122 201  3482 083 032  1878 004 832  3151 000 034	430 10 MFZ430 430WGTZ KZISZ-5				
			 1882 017 131	420 GF420XN	Nebenantriebs-ID / PTO ID: 130E	(48)		
			 1878 086 941	420 10 420WGTZ	Nebenantriebs-ID / PTO ID: 130E	(48)		





























		CODE		 Parameter		
--	--	------	--	---	---	---

MAN

17 ...						
17.170	D0226MKF	 3482 060 233	350 MF350	Getr. / GBox: ZF-S6-36		
		 1861 777 037	350 10 350GTD	Getr. / GBox: ZF-S6-36		
		 3151 199 001	KZIS-3	Getr. / GBox: ZF-S6-36		
		 3482 017 033	380 GMF380	Getr. / GBox: ZF-S6-65		
		 1878 001 152	380 10 380WGTZ	Getr. / GBox: ZF-S6-65		
		 3151 000 395	KZIS-4	Getr. / GBox: ZF-S6-65		
17.192	D0826MKF	 3482 017 033	380 GMF380			
		 1878 001 152	380 10 380WGTZ			
		 3151 000 395	KZIS-4			
17.220 529	D2566MF	 1882 302 131	380 GF380			
		 1878 001 152	380 10 380WGTZ			
		 3151 000 395	KZIS-4			
17.240 520		 1882 302 131	380 GF380			
		 1878 001 152	380 10 380WGTZ			
		 3151 000 395	KZIS-4			
19 ...						
19.168		 1878 001 079	350 10 350GTZ	Nebenantriebs-ID / PTO ID: 80		(48)
19.192						
19.168	D2555M	 3482 002 234	350 GMF350X			
		 1878 001 144	350 10 350WGTZ			
		 1878 001 147 #	350 10 350WGTZ			
		 3151 000 958	KZIS-4			
19.186 FN 19.192 FNM		 1882 110 532 #	350 GF350			
		 1878 005 367	350 10 350WGTZ			
		 3151 000 395	KZIS-4			
19.186 H		 1882 110 532 #	350 GF350			
		 3151 000 395	KZIS-4			
19.192	D2565M	 3482 002 234 HD	350 GMF350X			
		 1882 209 335 ●#	350 GF350			
		 1878 001 144	350 10 350WGTZ			
		 1878 001 147 #	350 10 350WGTZ			
		 3151 000 958	KZIS-4			
19.215 117		 3151 000 395	KZIS-4			
19.230 117						
19.220 527,529	D2566MF	 1882 302 131	380 GF380			
		 1878 001 152	380 10 380WGTZ			
		 3151 000 395	KZIS-4			

























		CODE					
--	--	------	--	--	---	---	---



































MAN

19 ...							
19.232				1882 302 131	380 GF380		
				1878 001 152	380 10 380WGTZ		
				3151 000 395	KZIS-4		
19.233		D2866LF		3400 700 327 ⊙ 3482 114 031 ⊙ 1878 004 832 ⊙ 3151 263 031	430 10 GMFZ430N 430WGTZ KZIZ-6	für Fahrzeuge mit Nebenantrieb / for vehicles with PTO für Nebenantrieb / for PTO	(73) (82)
19.240		D2556MF		1882 302 131	380 GF380		
				1878 001 152	380 10 380WGTZ		
				3151 000 395	KZIS-4		
				3482 124 534 HD	430 GMF430		
				1882 301 239 HD ●	420 GF420		
				1878 003 657 HD	420 10 420WGTZ		
				3151 000 395 HD	KZIS-4	ZF-Getriebe / ZF Transmission	(59)
				3151 067 032 HD	KZI4,5	Fuller-Getriebe / Fuller Transmission	(22)
19.250 DF 19.256 DH 19.275 D,DF 19.304 DF				3482 124 541	430 GMF430		
				1882 330 032 ●#	420 GF420		
				1878 001 155 ▲#	420 10 420WGTZ		
				3151 000 395	KZIS-4		
19.256		D2566MF		1861 526 046	420 10 420GSZ	Nebenantriebs-ID / PTO ID: 110	(48)
19.256				3482 124 534	430 GMF430		
				1882 301 239 ●	420 GF420		
				1878 003 657	420 10 420WGTZ		
				3151 067 032	KZI4,5	Fuller-Getriebe / Fuller Transmission	(22)
				3151 000 395	KZIS-4	ZF-Getriebe / ZF Transmission	(59)
		D2538M		1882 302 131	380 GF380		
				1878 001 152	380 10 380WGTZ		
				3151 000 395	KZIS-4		
19.280				3482 124 534	430 GMF430		
				1882 301 239 ●	420 GF420		
				1878 003 657	420 10 420WGTZ		
				3151 067 032	KZI4,5	Fuller-Getriebe / Fuller Transmission	(22)
				3151 000 395	KZIS-4	ZF-Getriebe / ZF Transmission	(59)
19.281 19.291 19.321		D2566MKF		1882 346 131 #	420 GF420XN	Nebenantriebs-ID / PTO ID: 130	(48)
				1861 876 134 #	420 10 420GVZ	Nebenantriebs-ID / PTO ID: 130	(48)

		CODE					
--	--	------	--	--	---	---	---

MAN



























19 ...							
19.281 19.291 504 19.321 19.331 504 19.361 504		D2866		1800 125 501 # ⊗ 1882 342 134 ⊗ 1861 911 232 ◦ 3151 067 032	420 10 GF420X 420WGVZ KZI4,5		
				1888 015 346	380 GF2/380	Je nach Kundenwunsch mit unterschiedlicher Kupplung / Equipped with different clutch according to customer requirement enthält eine Kupplungsscheibe / This part number includes one clutch disc	(33) (66)
				1861 748 132 ▽	380 6 380GSZ	Lose Kupplungsscheibe / Loose clutch disc	(39)
				3151 000 395	KZIS-4		
				1882 280 112	380 GF2/380	In 1888 enthalten / Contained in 1888	(29)
				1859 212 001	380 GF2/380	In 1888 enthalten / Contained in 1888	(29)
				1861 749 132 △	380 10 380WGSZ	In 1888 enthalten / Contained in 1888	(29)
			19.320		D2538MT, D2530MF		3482 124 534
	1882 301 239 ●	420 GF420					
	1878 003 657	420 10 420WGTZ					
	3151 067 032	KZI4,5				Fuller-Getriebe / Fuller Transmission	(22)
	3151 000 395	KZIS-4				ZF-Getriebe / ZF Transmission	(59)
19.320 U,UL 902,918				1878 000 967 ▽	380 10 380GTZ	Lose Kupplungsscheibe / Loose clutch disc	(39)
				3151 000 395	KZIS-4		
				1882 280 213	380 GF2/380	In 1888 enthalten / Contained in 1888	(29)
				1859 212 000	380 GF2/380	In 1888 enthalten / Contained in 1888	(29)
				1878 000 964 △	380 10 380GTZ	In 1888 enthalten / Contained in 1888	(29)
19.331 U 923		D2866LUL		1882 342 134	420 GF420X		
				1878 002 706	420 10 420GTZ		
				3151 000 395	KZIS-4		
19.361		D2566KFZ		1882 346 131 #	420 GF420XN	Nebenantriebs-ID / PTO ID: 130	(48)
				1861 876 134 #	420 10 420GVZ	Nebenantriebs-ID / PTO ID: 130	(48)
19.361		D2866		1800 125 501 # ⊗ 1882 342 134 ⊗ 1861 911 232 ◦ 3151 067 032	420 10 GF420X 420WGVZ KZI4,5		
20 ...							
20.192 D,DHR		D2555		1882 209 335 #	350 GF350		
				1878 001 144	350 10 350WGTZ		
				1878 001 147 #	350 10 350WGTZ		
				3151 000 958	KZIS-4		

20 ...						
20.240			 1882 302 131	380 GF380		
			 1878 001 152	380 10 380WGTZ		
			 3151 000 395	KZIS-4		
			 3482 124 534 HD	430 GMF430		
			 1882 301 239 HD ●	420 GF420		
			 1878 003 657 HD	420 10 420WGTZ		
			 3151 000 395 HD	KZIS-4	ZF-Getriebe / ZF Transmission	(59)
			 3151 067 032 HD	KZI4,5	Fuller-Getriebe / Fuller Transmission	(22)
			20.280			 3482 124 534
1882 301 239 ●	420 GF420					
 1878 003 657	420 10 420WGTZ					
 3151 067 032	KZI4,5	Fuller-Getriebe / Fuller Transmission				(22)
 3151 000 395	KZIS-4	ZF-Getriebe / ZF Transmission				(59)
20.281 20.321		D2866	 1800 125 501 #	420 10 GF420X		
			 1882 342 134	420WGVZ		
			 1861 911 232	KZI4,5		
			 3151 067 032			
			 1888 015 346	380 GF2/380	Je nach Kundenwunsch mit unterschiedlicher Kupplung / Equipped with different clutch according to customer requirement enthält eine Kupplungsscheibe / This part number includes one clutch disc	(33) (66)
			 1861 748 132 ▽	380 6 380GSZ	Lose Kupplungsscheibe / Loose clutch disc	(39)
			 3151 000 395	KZIS-4		
			 1882 280 112	380 GF2/380	In 1888 enthalten / Contained in 1888	(29)
			 1859 212 001	380 GF2/380	In 1888 enthalten / Contained in 1888	(29)
20.320		D2530MF	 3482 124 534	430 GMF430		
			1882 301 239 ●	420 GF420		
			 1878 003 657	420 10 420WGTZ		
			 3151 067 032	KZI4,5	Fuller-Getriebe / Fuller Transmission	(22)
			 3151 000 395	KZIS-4	ZF-Getriebe / ZF Transmission	(59)
20.331		D2866	 1800 125 501 #	420 10 GF420X		
			 1882 342 134	420WGVZ		
			 1861 911 232	KZI4,5		
			 3151 067 032			
			 1888 015 346	380 GF2/380	Je nach Kundenwunsch mit unterschiedlicher Kupplung / Equipped with different clutch according to customer requirement enthält eine Kupplungsscheibe / This part number includes one clutch disc	(33) (66)
			 1861 748 132 ▽	380 6 380GSZ	Lose Kupplungsscheibe / Loose clutch disc	(39)
			 3151 000 395	KZIS-4		
			 1882 280 112	380 GF2/380	In 1888 enthalten / Contained in 1888	(29)
			 1859 212 001	380 GF2/380	In 1888 enthalten / Contained in 1888	(29)
 1861 749 132 △	380 10 380WGSZ	In 1888 enthalten / Contained in 1888	(29)			

		CODE				
--	--	------	--	---	---	---

































MAN

21 ...						
21.212				3151 000 395	KZIS-4	
21.215						

22 ...						
22.186 H				1882 110 532 #	350 GF350	
				3151 000 395	KZIS-4	
22.192		D2156MYN		1882 110 532 #	350 GF350	
				1878 005 367	350 10 350WGTZ	
				3151 000 395	KZIS-4	
		D2565M		3482 002 234 HD	350 GMF350X	
				1882 209 335 #	350 GF350	
				1878 001 144	350 10 350WGTZ	
				1878 001 147 #	350 10 350WGTZ	
				3151 000 958	KZIS-4	
22.220 522	01.81 - 12.88	D2556MF		1882 302 131	380 GF380	Je nach Kundenwunsch mit unterschiedlicher Kupplung / Equipped with different clutch according to customer requirement (33)
22.240 522	01.81 - 12.88			1878 001 152	380 10 380WGTZ	
				3482 124 534	430 GMF430	Je nach Kundenwunsch mit unterschiedlicher Kupplung / Equipped with different clutch according to customer requirement (33)
				1882 301 239 ●	420 GF420	Je nach Kundenwunsch mit unterschiedlicher Kupplung / Equipped with different clutch according to customer requirement (33)
				1878 003 657	420 10 420WGTZ	
				3151 000 395	KZIS-4	
22.230				3151 000 395	KZIS-4	
22.242	07.90 -	D2866		1882 017 131	420 GF420XN	Nebenantriebs-ID / PTO ID: 130E (48)
22.292	07.90 -			1878 086 941	420 10 420WGTZ	Nebenantriebs-ID / PTO ID: 130E (48)
22.302	07.90 -					
22.332	07.90 -					
22.362	07.90 -					
22.372	07.90 -					
22.422	07.90 -					
22.256 DH 22.304 DF				3482 124 541	430 GMF430	
				1882 330 032 ●#	420 GF420	
				1878 001 155 ▲#	420 10 420WGTZ	
				3151 000 395	KZIS-4	
22.262	07.90 -	D2865		1882 017 131	420 GF420XN	Nebenantriebs-ID / PTO ID: 130E (48)
22.272	07.90 -			1878 086 941	420 10 420WGTZ	Nebenantriebs-ID / PTO ID: 130E (48)
22.322	07.90 -					
22.280				3482 124 534	430 GMF430	
				1882 301 239 ●	420 GF420	
				1878 003 657	420 10 420WGTZ	
				3151 067 032	KZ14,5	Fuller-Getriebe / Fuller Transmission (22)
				3151 000 395	KZIS-4	ZF-Getriebe / ZF Transmission (59)

		CODE					
--	--	------	--	--	---	---	---







MAN

22 ...							
22.281 506	01.80 - 12.88	D2866		1800 125 501 # ● 1882 342 134 ● 1861 911 232 ● 3151 067 032	420 10 GF420X 420WGVZ KZI4,5		
22.291 506	01.80 - 12.88			<u>1888 015 346</u>	380 GF2/380	enthält eine Kupplungsscheibe / This part number includes one clutch disc	(66)
22.321 506	01.80 - 12.88			<u>1861 748 132</u> ▽	380 6 380GSZ	Lose Kupplungsscheibe / Loose clutch disc	(39)
22.331 506	01.80 - 12.88			<u>3151 000 395</u>	KZIS-4		
22.361 506	01.80 - 12.88			1882 280 112	380 GF2/380	In 1888 enthalten / Contained in 1888	(29)
				1859 212 001	380 GF2/380	In 1888 enthalten / Contained in 1888	(29)
				1861 749 132 △	380 10 380WGSZ	In 1888 enthalten / Contained in 1888	(29)
22.320		D2530MF		3482 124 534	430 GMF430		
				1882 301 239 ●	420 GF420		
				1878 003 657	420 10 420WGTZ		
				3151 067 032	KZI4,5	Fuller-Getriebe / Fuller Transmission	(22)
				3151 000 395	KZIS-4	ZF-Getriebe / ZF Transmission	(59)
22.320 UNL 904				<u>1878 000 967</u> ▽	380 10 380GTZ	Lose Kupplungsscheibe / Loose clutch disc	(39)
				<u>3151 000 395</u>	KZIS-4		
				1882 280 213	380 GF2/380	In 1888 enthalten / Contained in 1888	(29)
				1859 212 000	380 GF2/380	In 1888 enthalten / Contained in 1888	(29)
				1878 000 964 △	380 10 380GTZ	In 1888 enthalten / Contained in 1888	(29)
22.361 930		D2866		1800 125 501 # ● 1882 342 134 ● 1861 911 232 ● 3151 067 032	420 10 GF420X 420WGVZ KZI4,5		
22.403 22.463	01.97 - 01.97 -	D2866, 2867		3400 122 201 ● 3482 083 032 ● 1878 004 832 ● 3151 000 034	430 10 MFZ430 430WGTZ KZISZ-5		
24 ...							
24.220 522	01.81 - 12.88	D2556MF		1882 302 131	380 GF380	Je nach Kundenwunsch mit unterschiedlicher Kupplung / Equipped with different clutch according to customer requirement	(33)
24.240 522	01.81 - 12.88			1878 001 152	380 10 380WGTZ		
				3482 124 534	430 GMF430	Je nach Kundenwunsch mit unterschiedlicher Kupplung / Equipped with different clutch according to customer requirement	(33)
				1882 301 239 ●	420 GF420	Je nach Kundenwunsch mit unterschiedlicher Kupplung / Equipped with different clutch according to customer requirement	(33)
				1878 003 657	420 10 420WGTZ		
				<u>3151 000 395</u>	KZIS-4		
24.242 24.292 24.362	07.90 - 07.90 - 07.90 -	D2866		1882 017 131	420 GF420XN	Nebenantriebs-ID / PTO ID: 130E	(48)
				1878 086 941	420 10 420WGTZ	Nebenantriebs-ID / PTO ID: 130E	(48)
				3151 204 001	KZI-6	mit Schmierrohranschluß / with lubricating pipe coupling	(91)
						Nebenantriebs-ID / PTO ID: 130E	(48)
24.262	07.90 -	D2865		1882 017 131	420 GF420XN	Nebenantriebs-ID / PTO ID: 130E	(48)
				1878 086 941	420 10 420WGTZ	Nebenantriebs-ID / PTO ID: 130E	(48)
				3151 204 001	KZI-6	mit Schmierrohranschluß / with lubricating pipe coupling	(91)
						Nebenantriebs-ID / PTO ID: 130E	(48)

















		CODE					
--	--	------	--	--	---	---	---

MAN

24 ...

24.291 506	01.80 - 12.88	D2866		1800 125 501 # ⊗ 1882 342 134 ⊗ 1861 911 232 ⊙ 3151 067 032	420 10 GF420X 420WGVZ KZI4,5		
24.331 506	01.80 - 12.88			1888 015 346	380 GF2/380	Je nach Kundenwunsch mit unterschiedlicher Kupplung / Equipped with different clutch according to customer requirement enthält eine Kupplungsscheibe / This part number includes one clutch disc	(33) (66)
24.361 506	01.80 - 12.88			1861 748 132 ▽	380 6 380GSZ	Lose Kupplungsscheibe / Loose clutch disc	(39)
				3151 000 395	KZIS-4		
				1882 280 112	380 GF2/380	In 1888 enthalten / Contained in 1888	(29)
				1859 212 001	380 GF2/380	In 1888 enthalten / Contained in 1888	(29)
				1861 749 132 △	380 10 380WGSZ	In 1888 enthalten / Contained in 1888	(29)

25 ...

































25.220 522	01.81 - 12.88	D2556MF		1882 302 131	380 GF380	Je nach Kundenwunsch mit unterschiedlicher Kupplung / Equipped with different clutch according to customer requirement	(33)
25.240 522	01.81 - 12.88			1878 001 152	380 10 380WGTZ		
				3482 124 534	430 GMF430	Je nach Kundenwunsch mit unterschiedlicher Kupplung / Equipped with different clutch according to customer requirement	(33)
				1882 301 239 ●	420 GF420	Je nach Kundenwunsch mit unterschiedlicher Kupplung / Equipped with different clutch according to customer requirement	(33)
				1878 003 657	420 10 420WGTZ		
				3151 000 395	KZIS-4		
25.242 25.292 25.332 25.362	07.90 - 07.90 - 07.90 - 07.90 -	D2866		1882 017 131	420 GF420XN	Nebenantriebs-ID / PTO ID: 130E	(48)
				1878 086 941	420 10 420WGTZ	Nebenantriebs-ID / PTO ID: 130E	(48)
25.262	07.90 -	D2865		1882 017 131	420 GF420XN	Nebenantriebs-ID / PTO ID: 130E	(48)
				1878 086 941	420 10 420WGTZ	Nebenantriebs-ID / PTO ID: 130E	(48)
25.291 506	01.80 - 12.88	D2866		1800 125 501 # ⊗ 1882 342 134 ⊗ 1861 911 232 ⊙ 3151 067 032	420 10 GF420X 420WGVZ KZI4,5		
25.331 506	01.80 - 12.88			1888 015 346	380 GF2/380	Je nach Kundenwunsch mit unterschiedlicher Kupplung / Equipped with different clutch according to customer requirement enthält eine Kupplungsscheibe / This part number includes one clutch disc	(33) (66)
25.361 506	01.80 - 12.88			1861 748 132 ▽	380 6 380GSZ	Lose Kupplungsscheibe / Loose clutch disc	(39)
				3151 000 395	KZIS-4		
				1882 280 112	380 GF2/380	In 1888 enthalten / Contained in 1888	(29)
				1859 212 001	380 GF2/380	In 1888 enthalten / Contained in 1888	(29)
				1861 749 132 △	380 10 380WGSZ	In 1888 enthalten / Contained in 1888	(29)

26 ...

26.215 117				3151 000 395	KZIS-4		
26.230 117							

































		CODE		 Parameter		
--	--	------	--	---	---	---

MAN











26 ...						
26.220 522 26.240 522	01.81 - 12.88	D2556MF	 1882 302 131	380 GF380	Je nach Kundenwunsch mit unterschiedlicher Kupplung / Equipped with different clutch according to customer requirement	(33)
	01.81 - 12.88		 1878 001 152	380 10 380WGTZ		
			 3482 124 534	430 GMF430	Je nach Kundenwunsch mit unterschiedlicher Kupplung / Equipped with different clutch according to customer requirement	(33)
			 1882 301 239 ●	420 GF420	Je nach Kundenwunsch mit unterschiedlicher Kupplung / Equipped with different clutch according to customer requirement	(33)
			 1878 003 657	420 10 420WGTZ		
			 3151 000 395	KZIS-4		
26.232			 1882 302 131	380 GF380		
			 1878 001 152	380 10 380WGTZ		
			 3151 000 395	KZIS-4		
26.240		D2566MF	 1861 526 046	420 10 420GSZ	Nebenantriebs-ID / PTO ID: 110	(48)
			 3482 124 534 HD	430 GMF430		
			 1882 301 239 HD ●	420 GF420		
			 1878 003 657 HD	420 10 420WGTZ		
			 3151 000 395 HD	KZIS-4	ZF-Getriebe / ZF Transmission	(59)
			 3151 067 032 HD	KZI4,5	Fuller-Getriebe / Fuller Transmission	(22)
26.256		D2538M, MF	 1882 302 131	380 GF380		
			 1878 001 152	380 10 380WGTZ		
			 3151 000 395	KZIS-4		
			 1882 301 239 ●	420 GF420		
			 3482 124 534	430 GMF430		
			 1878 003 657	420 10 420WGTZ		
			 3151 000 395	KZIS-4	ZF-Getriebe / ZF Transmission	(59)
			 3151 067 032	KZI4,5	Fuller-Getriebe / Fuller Transmission	(22)
26.256 H 26.304 DFL			 3482 124 541	430 GMF430		
			1882 330 032 ●#	420 GF420		
			 1878 001 155 ▲#	420 10 420WGTZ		
			 3151 000 395	KZIS-4		
26.280 26.304			 3482 124 534	430 GMF430		
			1882 301 239 ●	420 GF420		
			 1878 003 657	420 10 420WGTZ		
			 3151 067 032	KZI4,5	Fuller-Getriebe / Fuller Transmission	(22)
26.281 26.321		D2566MKF	 3151 000 395	KZIS-4	ZF-Getriebe / ZF Transmission	(59)
			 1882 346 131 #	420 GF420XN	Nebenantriebs-ID / PTO ID: 130	(48)
			 1861 876 134 #	420 10 420GVZ	Nebenantriebs-ID / PTO ID: 130	(48)

		CODE				
--	--	------	--	---	---	---





MAN

26 ...						
26.281 507 26.321 507	01.80 - 09.94	D2866MK	 1800 125 501 #  1882 342 134  1861 911 232  3151 067 032	420 10 GF420X 420WGVZ KZI4,5		
	01.80 - 09.94		 1888 015 346	380 GF2/380	Je nach Kundenwunsch mit unterschiedlicher Kupplung / Equipped with different clutch according to customer requirement enthält eine Kupplungsscheibe / This part number includes one clutch disc	(33) (66)
			 1861 748 132 ▽	380 6 380GSZ	Lose Kupplungsscheibe / Loose clutch disc	(39)
			 3151 000 395	KZIS-4		
			 1882 280 112	380 GF2/380	In 1888 enthalten / Contained in 1888	(29)
			 1859 212 001	380 GF2/380	In 1888 enthalten / Contained in 1888	(29)
			 1861 749 132 △	380 10 380WGSZ	In 1888 enthalten / Contained in 1888	(29)
26.291 506,509 26.331 506	01.80 - 12.88	D2866	 1800 125 501 #  1882 342 134  1861 911 232  3151 067 032	420 10 GF420X 420WGVZ KZI4,5		
	01.80 - 12.88		 1888 015 346	380 GF2/380	Je nach Kundenwunsch mit unterschiedlicher Kupplung / Equipped with different clutch according to customer requirement enthält eine Kupplungsscheibe / This part number includes one clutch disc	(33) (66)
			 1861 748 132 ▽	380 6 380GSZ	Lose Kupplungsscheibe / Loose clutch disc	(39)
			 3151 000 395	KZIS-4		
			 1882 280 112	380 GF2/380	In 1888 enthalten / Contained in 1888	(29)
			 1859 212 001	380 GF2/380	In 1888 enthalten / Contained in 1888	(29)
			 1861 749 132 △	380 10 380WGSZ	In 1888 enthalten / Contained in 1888	(29)
26.320		D2538MT, D2530MF	 3482 124 534	430 GMF430		
			1882 301 239 ●	420 GF420		
			 1878 003 657	420 10 420WGTZ		
			 3151 067 032	KZI4,5	Fuller-Getriebe / Fuller Transmission	(22)
			 3151 000 395	KZIS-4	ZF-Getriebe / ZF Transmission	(59)
26.361 506	01.80 - 12.88	D2866	 1882 342 134	420 GF420X	Je nach Kundenwunsch mit unterschiedlicher Kupplung / Equipped with different clutch according to customer requirement	(33)
			 1861 911 232	420 10 420WGVZ		
			 3151 067 032	KZI4,5		
			 1888 015 346	380 GF2/380	Je nach Kundenwunsch mit unterschiedlicher Kupplung / Equipped with different clutch according to customer requirement enthält eine Kupplungsscheibe / This part number includes one clutch disc	(33) (66)
			 1861 748 132 ▽	380 6 380GSZ	Lose Kupplungsscheibe / Loose clutch disc	(39)
			 3151 000 395	KZIS-4		
			 1882 280 112	380 GF2/380	In 1888 enthalten / Contained in 1888	(29)
			 1859 212 001	380 GF2/380	In 1888 enthalten / Contained in 1888	(29)
		 1861 749 132 △	380 10 380WGSZ	In 1888 enthalten / Contained in 1888	(29)	





26 ...

26.365 547	02.83 - 06.90	D2840MF	 1800 125 501 #  1882 342 134  1861 911 232  3151 067 032	420 10 GF420X 420WGVZ KZI4,5		
			 1888 015 346	380 GF2/380	Je nach Kundenwunsch mit unterschiedlicher Kupplung / Equipped with different clutch according to customer requirement enthält eine Kupplungsscheibe / This part number includes one clutch disc	(33) (66)
			 1861 748 132 ▽	380 6 380GSZ	Lose Kupplungsscheibe / Loose clutch disc	(39)
			 3151 000 395	KZIS-4		
			 1882 280 112	380 GF2/380	In 1888 enthalten / Contained in 1888	(29)
			 1859 212 001	380 GF2/380	In 1888 enthalten / Contained in 1888	(29)
			 1861 749 132 △	380 10 380WGSZ	In 1888 enthalten / Contained in 1888	(29)













27 ...

27.343	01.94 -	D2865LF09	 3400 122 301  3482 083 032  1878 080 034  3151 000 034	430 10 MFZ430 430WGTZ KZISZ-5		
--------	---------	-----------	---	---	--	--

28 ...































28.272	01.90 - 01.88 - 01.88 -	D2865LF	 1882 017 131	420 GF420XN	Nebenantriebs-ID / PTO ID: 130E	(48)
28.322			 1878 086 941	420 10 420WGTZ	Nebenantriebs-ID / PTO ID: 130E	(48)
28.342						
28.402						
28.292	01.86 - 01.90 - 01.86 - 01.90 - 01.90 -	D2866LF	 1882 017 131	420 GF420XN	Nebenantriebs-ID / PTO ID: 130E	(48)
28.302			 1878 086 941	420 10 420WGTZ	Nebenantriebs-ID / PTO ID: 130E	(48)
28.332						
28.372						
28.422						

30 ...

30.230			 3151 000 395	KZIS-4		
30.232			 1882 302 131	380 GF380		
			 1878 001 152	380 10 380WGTZ		
			 3151 000 395	KZIS-4		
30.240		D2538M	 1882 302 131	380 GF380		
			 1878 001 152	380 10 380WGTZ		
			 3151 000 395	KZIS-4		
		D2566MF	 1861 526 046	420 10 420GSZ	Nebenantriebs-ID / PTO ID: 110	(48)
			 3482 124 534 HD	430 GMF430		
			 1882 301 239 HD ●	420 GF420		
			 1878 003 657 HD	420 10 420WGTZ		
			 3151 000 395 HD	KZIS-4	ZF-Getriebe / ZF Transmission	(59)
			 3151 067 032 HD	KZI4,5	Fuller-Getriebe / Fuller Transmission	(22)

		CODE				
--	--	------	--	---	---	---





























MAN

30 ...						
30.256		D2538M	 1882 302 131	380 GF380		
			 1878 001 152	380 10 380WGTZ		
			 3151 000 395	KZIS-4		
			 3482 124 534	430 GMF430		
		 1882 301 239 ●	420 GF420			
		 1878 003 657	420 10 420WGTZ			
		 3151 000 395	KZIS-4	ZF-Getriebe / ZF Transmission	(59)	
		 3151 067 032	KZI4,5	Fuller-Getriebe / Fuller Transmission	(22)	
30.256 H			 3482 124 541	430 GMF430		
			1882 330 032 ●#	420 GF420		
			 1878 001 155 ▲#	420 10 420WGTZ		
			 3151 000 395	KZIS-4		
30.262 30.272 30.322	01.89- 01.92- 01.90-	D2865LF	 1882 017 131	420 GF420XN	Nebenantriebs-ID / PTO ID: 130E	(48)
			 1878 086 941	420 10 420WGTZ	Nebenantriebs-ID / PTO ID: 130E	(48)
30.280			 3482 124 534	430 GMF430		
			 1882 301 239 ●	420 GF420		
			 1878 003 657	420 10 420WGTZ		
			 3151 000 395	KZIS-4	ZF-Getriebe / ZF Transmission	(59)
			 3151 067 032	KZI4,5	Fuller-Getriebe / Fuller Transmission	(22)
		D2566MF	 1861 526 046	420 10 420GSZ	Nebenantriebs-ID / PTO ID: 110	(48)
30.281 512 30.321 512		D2566	 <u>1888 015 346</u>	380 GF2/380	->07.1983 enthält eine Kupplungsscheibe / This part number includes one clutch disc	(66)
			 <u>1861 748 132</u> ▽	380 6 380GSZ	->07.1983 Lose Kupplungsscheibe / Loose clutch disc	(39)
			 <u>3151 000 395</u>	KZIS-4	->07.1983	
			 1882 280 112	380 GF2/380	->07.1983 In 1888 enthalten / Contained in 1888	(29)
			 1859 212 001	380 GF2/380	->07.1983 In 1888 enthalten / Contained in 1888	(29)
			 1861 749 132 △	380 10 380WGSZ	->07.1983 In 1888 enthalten / Contained in 1888	(29)
			 1800 125 501 #  1882 342 134  1861 911 232  3151 067 032	420 10 GF420X 420WGVZ KZI4,5	08.1983->	
			 1882 346 131 #	420 GF420XN	Nebenantriebs-ID / PTO ID: 130/1	(48)
			 1861 876 134 #	420 10 420GVZ	Nebenantriebs-ID / PTO ID: 130/1	(48)

		CODE					
--	--	------	--	--	---	---	---

MAN

30 ...







30.291 512,513 30.331 512,513		D2566	 1888 015 346	380 GF2/380	->07.1983 512 enthält eine Kupplungsscheibe / This part number includes one clutch disc (66)
			 1861 748 132 ▽	380 6 380GSZ	->07.1983 512 Lose Kupplungsscheibe / Loose clutch disc (39)
			 3151 000 395	KZIS-4	->07.1983 512
			 1882 280 112	380 GF2/380	->07.1983 512 In 1888 enthalten / Contained in 1888 (29)
			 1859 212 001	380 GF2/380	->07.1983 512 In 1888 enthalten / Contained in 1888 (29)
			 1861 749 132 △	380 10 380WGSZ	->07.1983 512 In 1888 enthalten / Contained in 1888 (29)
			 1800 125 501 #  1882 342 134  1861 911 232  3151 067 032	420 10 GF420X 420WGVZ KZI4,5	08.1983->
			 1882 346 131 #	420 GF420XN	Nebenantriebs-ID / PTO ID: 130/1 (48)
			 1861 876 134 #	420 10 420GVZ	Nebenantriebs-ID / PTO ID: 130/1 (48)
30.292 30.302 30.332 30.372 30.422	01.87- 01.90- 01.87- 01.90- 01.90-	D2866LF	 1882 017 131	420 GF420XN	Nebenantriebs-ID / PTO ID: 130E (48)
			 1878 086 941	420 10 420WGTZ	Nebenantriebs-ID / PTO ID: 130E (48)
30.304			 3482 124 534	430 GMF430	
			 1882 301 239 ●	420 GF420	
			 1878 003 657	420 10 420WGTZ	
			 3151 067 032	KZI4,5	Fuller-Getriebe / Fuller Transmission (22)
30.320		D2538MT, D2530MF	 3482 124 534	430 GMF430	
			 1882 301 239 ●	420 GF420	
			 1878 003 657	420 10 420WGTZ	
30.361 512,513		D2866	 3151 000 395	KZIS-4	ZF-Getriebe / ZF Transmission (59)
			 1800 125 501 #  1882 342 134  1861 911 232  3151 067 032	420 10 GF420X 420WGVZ KZI4,5	
30.362	01.87-	D2866KF, LXF	 1882 017 131	420 GF420XN	Nebenantriebs-ID / PTO ID: 130E (48)
			 1878 086 941	420 10 420WGTZ	Nebenantriebs-ID / PTO ID: 130E (48)























31 ...

31.262 31.272 31.322	01.89- 01.90-	D2865LF	 1882 017 131	420 GF420XN	Nebenantriebs-ID / PTO ID: 130E (48)
			 1878 086 941	420 10 420WGTZ	Nebenantriebs-ID / PTO ID: 130E (48)
31.292 31.302 31.332 31.372 31.422	01.87- 01.90- 01.87- 01.90- 01.90-	D2866LF	 1882 017 131	420 GF420XN	Nebenantriebs-ID / PTO ID: 130E (48)
			 1878 086 941	420 10 420WGTZ	Nebenantriebs-ID / PTO ID: 130E (48)

		CODE		 Parameter		
--	--	------	--	---	---	---



































MAN

31 ...						
31.342	01.94 -	D2865	 1882 017 131	420 GF420XN	Nebenantriebs-ID / PTO ID: 130E	(48)
			 1878 086 941	420 10 420WGTZ	Nebenantriebs-ID / PTO ID: 130E	(48)
31.362	01.87 -	D2866KF, LXF	 1882 017 131	420 GF420XN	Nebenantriebs-ID / PTO ID: 130E	(48)
			 1878 086 941	420 10 420WGTZ	Nebenantriebs-ID / PTO ID: 130E	(48)
31.402	01.94 -	D2866	 1882 017 131	420 GF420XN	Nebenantriebs-ID / PTO ID: 130E	(48)
			 1878 086 941	420 10 420WGTZ	Nebenantriebs-ID / PTO ID: 130E	(48)

32 ...						
32.232		D2556MF	 1882 302 131	380 GF380		
			 1878 001 152	380 10 380WGTZ		
			 3151 000 395	KZIS-4		
32.240		D2556MF	 1882 302 131	380 GF380		
			 1878 001 152	380 10 380WGTZ		
			 3151 000 395	KZIS-4		
		D2566MF	 1861 526 046	420 10 420GSZ	Nebenantriebs-ID / PTO ID: 110	(48)
			 3482 124 534 HD	430 GMF430		
			 1882 301 239 HD ●	420 GF420		
			 1878 003 657 HD	420 10 420WGTZ		
			 3151 000 395 HD	KZIS-4	ZF-Getriebe / ZF Transmission	(59)
			 3151 067 032 HD	KZI4,5	Fuller-Getriebe / Fuller Transmission	(22)
32.256		D2538M	 1882 302 131	380 GF380		
			 1878 001 152	380 10 380WGTZ		
			 3151 000 395	KZIS-4		
32.262	01.87 -	D2865LF	 1882 017 131	420 GF420XN	Nebenantriebs-ID / PTO ID: 130E	(48)
32.272	01.88 -		 1878 086 941	420 10 420WGTZ	Nebenantriebs-ID / PTO ID: 130E	(48)
32.322						
32.280		D2566MF	 1861 526 046	420 10 420GSZ	Nebenantriebs-ID / PTO ID: 110	(48)
32.280		D2530MF	 3482 124 534	430 GMF430		
			 1882 301 239 ●	420 GF420		
			 1878 003 657	420 10 420WGTZ		
			 3151 067 032	KZI4,5	Fuller-Getriebe / Fuller Transmission	(22)
			 3151 000 395	KZIS-4	ZF-Getriebe / ZF Transmission	(59)















		CODE				
--	--	------	--	---	---	---



















MAN

32 ...						
32.281 507 32.321 507	01.80 - 09.94	D2866MK	 1800 125 501 #  1882 342 134  1861 911 232  3151 067 032	420 10 GF420X 420WGVZ KZI4,5		
	01.80 - 09.94		 1888 015 346	380 GF2/380	Je nach Kundenwunsch mit unterschiedlicher Kupplung / Equipped with different clutch according to customer requirement enthält eine Kupplungsscheibe / This part number includes one clutch disc	(33) (66)
			 1861 748 132 ▽	380 6 380GSZ	Lose Kupplungsscheibe / Loose clutch disc	(39)
			 3151 000 395	KZIS-4		
			 1882 280 112	380 GF2/380	In 1888 enthalten / Contained in 1888	(29)
			 1859 212 001	380 GF2/380	In 1888 enthalten / Contained in 1888	(29)
			 1861 749 132 △	380 10 380WGSZ	In 1888 enthalten / Contained in 1888	(29)
32.291 512 32.331 512 32.361 512	08.83 - 08.83 -	D2866	 1800 125 501 #  1882 342 134  1861 911 232  3151 067 032	420 10 GF420X 420WGVZ KZI4,5		
			 1888 015 346	380 GF2/380	enthält eine Kupplungsscheibe / This part number includes one clutch disc	(66)
32.291 512 32.331 512	- 07.83 - 07.83	D2866	 1861 748 132 ▽	380 6 380GSZ	Lose Kupplungsscheibe / Loose clutch disc	(39)
			 3151 000 395	KZIS-4		
			 1882 280 112	380 GF2/380	In 1888 enthalten / Contained in 1888	(29)
			 1859 212 001	380 GF2/380	In 1888 enthalten / Contained in 1888	(29)
			 1861 749 132 △	380 10 380WGSZ	In 1888 enthalten / Contained in 1888	(29)
32.291 512 32.331 512 32.361 512		D2866	 1882 346 131 #	420 GF420XN	Nebenantriebs-ID / PTO ID: 130/1	(48)
			 1861 876 134 #	420 10 420GVZ	Nebenantriebs-ID / PTO ID: 130/1	(48)
32.292 32.332 32.372 32.422	01.85 - 01.85 - 01.88 - 01.88 -	D2866LF	 1882 017 131	420 GF420XN	Nebenantriebs-ID / PTO ID: 130E	(48)
			 1878 086 941	420 10 420WGTZ	Nebenantriebs-ID / PTO ID: 130E	(48)
32.320		D2538MT, D2530MF	 3482 124 534	430 GMF430		
			 1882 301 239 ●	420 GF420		
			 1878 003 657	420 10 420WGTZ		
			 3151 067 032	KZI4,5	Fuller-Getriebe / Fuller Transmission	(22)
			 3151 000 395	KZIS-4	ZF-Getriebe / ZF Transmission	(59)
32.320 DFA		D2530MF	 1888 015 523 #	380 GF2/380	enthält eine Kupplungsscheibe / This part number includes one clutch disc	(66)
			 1878 000 967 ▽	380 10 380GTZ	Lose Kupplungsscheibe / Loose clutch disc	(39)
			 3151 000 395	KZIS-4		
			 1882 280 213	380 GF2/380	In 1888 enthalten / Contained in 1888	(29)
			 1859 212 001	380 GF2/380	In 1888 enthalten / Contained in 1888	(29)
			 1878 000 964 △	380 10 380GTZ	In 1888 enthalten / Contained in 1888	(29)

		CODE				
--	--	------	--	---	---	---

















MAN

















32 ...						
32.342	01.94-	D2865		1882 017 131	420 GF420XN	Nebenantriebs-ID / PTO ID: 130E (48)
				1878 086 941	420 10 420WGTZ	Nebenantriebs-ID / PTO ID: 130E (48)
32.365 547	02.83 - 06.90	D2840MF		1800 125 501 #  1882 342 134  1861 911 232  3151 067 032	420 10 GF420X 420WGVZ KZI4,5	
				1888 015 346	380 GF2/380	Je nach Kundenwunsch mit unterschiedlicher Kupplung / Equipped with different clutch according to customer requirement enthält eine Kupplungsscheibe / This part number includes one clutch disc (33) (66)
				1861 748 132 ▽	380 6 380GSZ	Lose Kupplungsscheibe / Loose clutch disc (39)
				3151 000 395	KZIS-4	
				1882 280 112	380 GF2/380	In 1888 enthalten / Contained in 1888 (29)
				1859 212 001	380 GF2/380	In 1888 enthalten / Contained in 1888 (29)
				1861 749 132 △	380 10 380WGSZ	In 1888 enthalten / Contained in 1888 (29)
			32.462	01.85 -	D2840LF	
	1878 086 941	420 10 420WGTZ				Nebenantriebs-ID / PTO ID: 130E (48)







33 ...						
33.240 427				1882 302 131	380 GF380	
				1878 001 152	380 10 380WGTZ	
				3151 000 395	KZIS-4	
33.240 33.280		D2566MF		1861 526 046	420 10 420GSZ	Nebenantriebs-ID / PTO ID: 110 (48)
33.280 33.320		D2530MF		3482 124 534	430 GMF430	
				1882 301 239 ●	420 GF420	
				1878 003 657	420 10 420WGTZ	
				3151 067 032	KZI4,5	Fuller-Getriebe / Fuller Transmission (22)
				3151 000 395	KZIS-4	ZF-Getriebe / ZF Transmission (59)
33.281		D2566MKF		1800 125 501 #  1882 342 134  1861 911 232  3151 067 032	420 10 GF420X 420WGVZ KZI4,5	
				1888 015 346	380 GF2/380	Je nach Kundenwunsch mit unterschiedlicher Kupplung / Equipped with different clutch according to customer requirement enthält eine Kupplungsscheibe / This part number includes one clutch disc (33) (66)
				1861 748 132 ▽	380 6 380GSZ	Lose Kupplungsscheibe / Loose clutch disc (39)
				3151 000 395	KZIS-4	
				1882 280 112	380 GF2/380	In 1888 enthalten / Contained in 1888 (29)
				1859 212 001	380 GF2/380	In 1888 enthalten / Contained in 1888 (29)
				1861 749 132 △	380 10 380WGSZ	In 1888 enthalten / Contained in 1888 (29)

		CODE		 Parameter		
--	--	------	--	---	---	---

MAN





33 ...						
33.291 512 33.321 512 33.331 512		D2866	 1888 015 346	380 GF2/380	->07.1983 enthält eine Kupplungsscheibe / This part number includes one clutch disc	(66)
			 1861 748 132 ▽	380 6 380GSZ	->07.1983 Lose Kupplungsscheibe / Loose clutch disc	(39)
			 3151 000 395	KZIS-4	->07.1983	
			 1882 280 112	380 GF2/380	->07.1983 In 1888 enthalten / Contained in 1888	(29)
			 1859 212 001	380 GF2/380	->07.1983 In 1888 enthalten / Contained in 1888	(29)
			 1861 749 132 △	380 10 380WGSZ	->07.1983 In 1888 enthalten / Contained in 1888	(29)
			 1800 125 501 #  1882 342 134  1861 911 232  3151 067 032	420 10 GF420X 420WGVZ KZI4,5	08.1983->	
			 1882 346 131 #	420 GF420XN	Nebenantriebs-ID / PTO ID: 130/1	(48)
			 1861 876 134 #	420 10 420GVZ	Nebenantriebs-ID / PTO ID: 130/1	(48)
33.361 512,513			 1800 125 501 #  1882 342 134  1861 911 232  3151 067 032	420 10 GF420X 420WGVZ KZI4,5		





34 ...						
34.291 512 34.331 512	-07.83	D2866	 1888 015 346	380 GF2/380	enthält eine Kupplungsscheibe / This part number includes one clutch disc	(66)
			 1861 748 132 ▽	380 6 380GSZ	Lose Kupplungsscheibe / Loose clutch disc	(39)
			 3151 000 395	KZIS-4		
			 1882 280 112	380 GF2/380	In 1888 enthalten / Contained in 1888	(29)
			 1859 212 001	380 GF2/380	In 1888 enthalten / Contained in 1888	(29)
			 1861 749 132 △	380 10 380WGSZ	In 1888 enthalten / Contained in 1888	(29)
			 1800 125 501 #  1882 342 134  1861 911 232  3151 067 032	420 10 GF420X 420WGVZ KZI4,5	08.1983->	
34.291 512 34.331 512 34.361 512		D2866	 1882 346 131 #	420 GF420XN	Nebenantriebs-ID / PTO ID: 130/1	(48)
			 1861 876 134 #	420 10 420GVZ	Nebenantriebs-ID / PTO ID: 130/1	(48)
34.361 512		D2866	 1800 125 501 #  1882 342 134  1861 911 232  3151 067 032	420 10 GF420X 420WGVZ KZI4,5		









35 ...						
35.332 35.372		D2866LF	 1882 017 131	420 GF420XN	Nebenantriebs-ID / PTO ID: 130E	(48)
			 1878 086 941	420 10 420WGTZ	Nebenantriebs-ID / PTO ID: 130E	(48)
			 3151 204 001	KZI-6	mit Schmierrohranschluß / with lubricating pipe coupling Nebenantriebs-ID / PTO ID: 130E	(91) (48)
35.362		D2866KF	 1882 017 131	420 GF420XN	Nebenantriebs-ID / PTO ID: 130E	(48)
			 1878 086 941	420 10 420WGTZ	Nebenantriebs-ID / PTO ID: 130E	(48)
			 3151 204 001	KZI-6	mit Schmierrohranschluß / with lubricating pipe coupling Nebenantriebs-ID / PTO ID: 130E	(91) (48)







		CODE				
--	--	------	--	---	---	---

MAN

36 ...						
36.291 513				1800 125 501 # ⊗ 1882 342 134 ⊗ 1861 911 232 ⊙ 3151 067 032	420 10 GF420X 420WGVZ KZI4,5	
36.331 513				1882 342 134	420 GF420X	
36.361 513				1861 911 232	420 10 420WGVZ	
				3151 067 032	KZI4,5	













38 ...						
38.262	01.85 -			3400 127 601 ⊗ 3482 078 133 ⊗ 1862 364 031 ⊙ 3151 000 034	400 10 MFZ400 400WGVZ KZISZ-5	Nabenprofil / Hub Profile: 2"-10N (46)
38.462	01.85 -	D2840LF		1882 017 131	420 GF420XN	Nebenantriebs-ID / PTO ID: 130E (48)
				1878 086 941	420 10 420WGTZ	Nebenantriebs-ID / PTO ID: 130E (48)
38.462	01.85 -	D2840LF		3400 122 201 ⊗ 3482 083 032 ⊗ 1878 004 832 ⊙ 3151 000 034	430 10 MFZ430 430WGTZ KZISZ-5	

40 ...						
40.242	01.85 -	D2865LF02, D2866F		3400 700 310 ⊗ 3482 078 133 ⊗ 1862 364 133 ⊙ 3151 000 034	400 10 MFZ400 400WGVZ KZISZ-5	Nabenprofil / Hub Profile: 1 3/4"-10N (46)
40.262 40.292	01.85 - 01.85 -			3400 127 601 ⊗ 3482 078 133 ⊗ 1862 364 031 ⊙ 3151 000 034	400 10 MFZ400 400WGVZ KZISZ-5	Nabenprofil / Hub Profile: 2"-10N (46)
40.332	01.85 -	D2866LF		3400 122 201 ⊗ 3482 083 032 ⊗ 1878 004 832 ⊙ 3151 000 034	430 10 MFZ430 430WGTZ KZISZ-5	
40.362	01.85 -	D2866KF, KU, LXF		3400 122 201 ⊗ 3482 083 032 ⊗ 1878 004 832 ⊙ 3151 000 034	430 10 MFZ430 430WGTZ KZISZ-5	
40.400 UNL 904				1878 000 967 ▽	380 10 380GTZ	Lose Kupplungsscheibe / Loose clutch disc (39)
				3151 000 395	KZIS-4	
				1882 280 213	380 GF2/380	In 1888 enthalten / Contained in 1888 (29)
				1859 212 000	380 GF2/380	In 1888 enthalten / Contained in 1888 (29)
				1878 000 964 △	380 10 380GTZ	In 1888 enthalten / Contained in 1888 (29)

















41 ...						
41.242	01.85 -	D2865LF02, D2866F		3400 127 601 ⊗ 3482 078 133 ⊗ 1862 364 031 ⊙ 3151 000 034	400 10 MFZ400 400WGVZ KZISZ-5	Nabenprofil / Hub Profile: 2"-10N (46)
				3400 700 310 ⊗ 3482 078 133 ⊗ 1862 364 133 ⊙ 3151 000 034	400 10 MFZ400 400WGVZ KZISZ-5	Nabenprofil / Hub Profile: 1 3/4"-10N (46)
41.291 513				1882 342 134	420 GF420X	
				1861 911 232	420 10 420WGVZ	
				3151 067 032	KZI4,5	
41.331 513				1800 125 501 # ⊗ 1882 342 134 ⊗ 1861 911 232 ⊙ 3151 067 032	420 10 GF420X 420WGVZ KZI4,5	
41.361 513						

		CODE				
--	--	------	--	---	---	---

MAN



















41 ...						
41.462	01.85-	D2840		1882 017 131	420	Nebenantriebs-ID / PTO ID: 130E (48)
41.502	01.85-			1878 086 941	420 10 GF420XN 420WGTZ	Nebenantriebs-ID / PTO ID: 130E (48)
47 ...						
47.292	01.89-	D2866LF		1882 017 131	420	Nebenantriebs-ID / PTO ID: 130E (48)
47.332	01.89-			1878 086 941	420 10 GF420XN 420WGTZ	Nebenantriebs-ID / PTO ID: 130E (48)
47.362	01.89-	D2866KF		1882 017 131	420	Nebenantriebs-ID / PTO ID: 130E (48)
				1878 086 941	420 10 GF420XN 420WGTZ	Nebenantriebs-ID / PTO ID: 130E (48)
48 ...						
48.291				1800 125 501 #	420 10	
513				1882 342 134	GF420X	
48.331				1861 911 232	420WGVZ	
513				3151 067 032	KZI4,5	
48.361						
513						
48.372	01.89-	D2866LF		1882 017 131	420	Nebenantriebs-ID / PTO ID: 130E (48)
48.402	01.89-			1878 086 941	420 10 GF420XN	Nebenantriebs-ID / PTO ID: 130E (48)
48.422	01.89-				420WGTZ	



MAZ







MAZ						
4370		DeutzBF4M101 3FC		3482 125 512	362	Getr. / GBox: ZF S5-42
				1878 079 331	362 10	Getr. / GBox: ZF S5-42
				3151 000 958	362WGTZ	Getr. / GBox: ZF S5-42
				3151 068 101	KZIS-4	Getr. / GBox: ZF S5-42
		Minski		3482 125 512	362	Getr. / GBox: Smolensk
				1878 079 331	362 10	Getr. / GBox: Smolensk
4570		MMZ245.9		3482 125 512	362	Getr. / GBox: Smolensk CAAZ-433420
				1878 079 306	362 10	Getr. / GBox: Smolensk CAAZ-433420
				3151 202 001	362WGTZ	Getr. / GBox: Smolensk CAAZ-433420
5336		DeutzBF6M101 3FC		3482 000 463	395	Getr. / GBox: ZF 9S 109
				1862 506 131	395 10	Getr. / GBox: ZF 9S - 75
				3151 000 419	395WGTZ	Getr. / GBox: ZF 9S - 75
5337		DeutzBF4M101 3FC		3482 000 463	395	Getr. / GBox: ZF 9S 109
				1862 506 131	395 10	Getr. / GBox: ZF 9S - 75
				3151 000 419	395WGTZ	Getr. / GBox: ZF 9S - 75
				3151 000 419	KZIS-4	Getr. / GBox: ZF 6S-850

		CODE				
--	--	------	--	---	---	---







MAZ

MAZ						
5516	DeutzBF6M101 3FC	 3482 000 463	395 MF395	Getr. / GBox: ZF 9S 109 Getr. / GBox: ZF 16S 109		
		 1862 506 131	395 10 395WGTZ	Getr. / GBox: ZF 9S 109 Getr. / GBox: ZF 16S 109		
		 3151 000 419	KZIS-4	Getr. / GBox: ZF 9S 109 Getr. / GBox: ZF 16S 109		
	DeutzBF6M101 5C	 3482 083 032	430 MFZ430	Getr. / GBox: ZF 16 S 221		
		 1878 004 832	430 10 430WGTZ	Getr. / GBox: ZF 16 S 221		
		 3151 000 034	KZISZ-5	Getr. / GBox: ZF 16 S 221		
5551	DeutzBF6M101 3EC	 3482 083 118	430 MFZ430	Getr. / GBox: ZF 9S 109		
		 1878 080 031	430 10 430WGTZ	Getr. / GBox: ZF 9S 109		
		 3151 000 157	KZISZ-5	Getr. / GBox: ZF 9S 109		
	DeutzBF6M101 3FC	 3482 000 463	395 MF395	Getr. / GBox: ZF 9S 109 Getr. / GBox: ZF 9S - 75		
		 1862 506 131	395 10 395WGTZ	Getr. / GBox: ZF 9S 109 Getr. / GBox: ZF 9S - 75		
		 3151 000 419	KZIS-4	Getr. / GBox: ZF 9S 109 Getr. / GBox: ZF 9S - 75		
6303	DeutzBF6M101 3FC	 3482 000 463	395 MF395	Getr. / GBox: ZF 9S 109 Getr. / GBox: ZF 16S 109		
		 1862 506 131	395 10 395WGTZ	Getr. / GBox: ZF 9S 109 Getr. / GBox: ZF 16S 109		
		 3151 000 419	KZIS-4	Getr. / GBox: ZF 9S 109 Getr. / GBox: ZF 16S 109		
631733	DeutzBF6M101 3FC	 3482 000 463	395 MF395	Getr. / GBox: ZF 9S 109		
		 1862 506 131	395 10 395WGTZ	Getr. / GBox: ZF 9S 109		
		 3151 202 001	KZI-4,5	Getr. / GBox: ZF 9S 109		

MAZ Baltija						
MAZ Baltija	DeutzBF6M101 3FC	 3482 000 463	395 MF395	Getr. / GBox: ZF 9S-109		
		 1862 506 131	395 10 395WGTZ	Getr. / GBox: ZF 9S-109		
		 3151 000 958	KZIS-4	Getr. / GBox: ZF 9S-109		

Truck						
631208 / 643008	YAMZ7511	 3482 083 032	430 MFZ430	Getr. / GBox: Shaanxi 9JS 180 A		
		 1878 004 832	430 10 430WGTZ	Getr. / GBox: Shaanxi 9JS 180 A		
		 3151 000 034	KZISZ-5	Getr. / GBox: Shaanxi 9JS 180 A		
544005 / 534005	YAMZ238DE	 3482 083 118	430 MFZ430	Getr. / GBox: Shaanxi 9JS 150 F		
		 1878 004 832	430 10 430WGTZ	Getr. / GBox: Shaanxi 9JS 150 F		
		 3151 000 034	KZISZ-5	Getr. / GBox: Shaanxi 9JS 150 F		













MERCEDES-BENZ

100 Kasten / Box (631) 02.88 - 02.96						
D (631.332, 631.342), 53 kW D (631.332, 631.342), 55 kW	02.88 - 05.92 12.90 - 02.96	OM616.963	 3000 424 002	228 23 M228		
			 3082 191 032	228LPB		
			 1862 375 031	KZIS-0		
			 3151 198 031			
			 3074 600 205		->10.1991 Hüllenlänge [mm] / Sleeve Length [mm]: 980 Länge [mm] / Length [mm]: 1450	(27) (42)
 6283 600 113		Chass. 099541->				
 6284 600 111		01.1991->				

































		CODE				
--	--	------	--	---	---	---

MERCEDES-BENZ

100 Pritsche / Flatbed (631) 02.88 - 02.96

D (631.340), 53 kW	02.88-05.92	OM616.963	 3000 424 002  3082 191 032  1862 375 031  3151 198 031	228 23 M228 228LPB KZIS-0		
			 3074 600 205		Hüllenlänge [mm] / Sleeve Length [mm]: 980 Länge [mm] / Length [mm]: 1450	(27) (42)
			 6284 600 111		01.1991->	
D (631.340), 55 kW	12.90-02.96	OM616.963	 3000 424 002  3082 191 032  1862 375 031  3151 198 031	228 23 M228 228LPB KZIS-0		
			 3074 600 205		Hüllenlänge [mm] / Sleeve Length [mm]: 980 Länge [mm] / Length [mm]: 1450	(27) (42)
			 6284 600 111			





















SPRINTER 2-t Kasten / Box (901, 902) 01.95 - 05.06

214	02.95-05.06	M111.979	 3000 826 901  3082 268 031  1878 994 001  3151 248 031	240 26 M240 240TB KZIS-0				
			 1863 869 010	35	Nadellager / Needle Bearing	(47)		
		M111.984	 3000 990 218  	240 26	XTend Kit plus CSC ->Chass. A920787 ->Chass. R636764 Nabenprofil / Hub Profile: 26,5x29-26N für Schwungradtiefe [mm] / for flywheel depth [mm]: 8	(46) (84)		
			 3000 990 252  	240 26	XTend Kit plus CSC Nabenprofil / Hub Profile: 26,5x29-26N für Schwungradtiefe [mm] / for flywheel depth [mm]: 12 Nur zusammen verbauen / Only install together	(46) (84) (51)		
			 3182 997 804 	HHAS-1	Immer erneuern / Renew everytime	(28)		
			 3182 997 802	HHAS-1	Schaltgetriebe sequentiell / Sequential Manual Transmission mit Sensor / with sensor Füllmedium: Mineralöl / Fill Medium: Mineral Oil Immer erneuern / Renew everytime	(54) (92) (24) (28)		
		M111.979, M111.984	 6283 600 115					
			 6284 600 573					
		214 NGT	04.00-05.06	M111.984	 3000 990 218  	240 26	XTend Kit plus CSC ->Chass. A920787 ->Chass. R636764 Nabenprofil / Hub Profile: 26,5x29-26N für Schwungradtiefe [mm] / for flywheel depth [mm]: 8	(46) (84)
					 3000 990 252  	240 26	XTend Kit plus CSC Nabenprofil / Hub Profile: 26,5x29-26N für Schwungradtiefe [mm] / for flywheel depth [mm]: 12 Nur zusammen verbauen / Only install together	(46) (84) (51)
 3182 997 804 	HHAS-1				Immer erneuern / Renew everytime	(28)		
 3182 997 802	HHAS-1				Schaltgetriebe sequentiell / Sequential Manual Transmission mit Sensor / with sensor Füllmedium: Mineralöl / Fill Medium: Mineral Oil Immer erneuern / Renew everytime	(54) (92) (24) (28)		
208 D, 58 kW 208 D, 60 kW	02.95-04.00	OM601.943	 2290 601 007  2294 000 767  3082 267 233  1864 503 231  3151 248 031  1874 000 006	228 26 M228X 228B KZIS-0	ZMS Modul Montageart: nicht vormontiert / Mounting Type: not pre-mounted Beinhaltet ZMS, Kupplungsdruckplatte, Kupplungsscheibe und Ausrücker / Contains twin-mass flywheel, clutch cover assembly, clutch disc and releaser enthält Schwungradbefestigungsschrauben / includes bolt for flywheel mounting	(43) (15) (65)		
			 1863 869 010	35	Nadellager / Needle Bearing	(47)		
	10.96-04.00	 6283 600 115						















		CODE				
--	--	------	--	---	---	---

MERCEDES-BENZ

SPRINTER 2-t Kasten / Box (901, 902) 01.95 - 05.06































208 CDI 211 CDI 213 CDI 216 CDI	04.00 - 05.06	OM611.981/987, OM612.981		2290 601 011 	240 26	ZMS Modul XTend plus CSC Montageart: nicht vormontiert / Mounting Type: not pre-mounted (43) Beinhaltet ZMS, Kupplungsdruckplatte, Kupplungsscheibe und CSC / Contains twin-mass flywheel, clutch cover assembly, clutch disc and CSC (16) enthält Schwungradbefestigungsschrauben / includes bolt for flywheel mounting (65)
				3000 990 218 	240 26	XTend Kit plus CSC ->Chass. A920787 ->Chass. R636764 Nabenprofil / Hub Profile: 26,5x29-26N (46) für Schwungradtiefe [mm] / for flywheel depth [mm]: 8 (84)
				3000 990 252 	240 26	XTend Kit plus CSC Nabenprofil / Hub Profile: 26,5x29-26N (46) für Schwungradtiefe [mm] / for flywheel depth [mm]: 12 (84) Nur zusammen verbauen / Only install together (51)
				3182 997 802	HHAS-1	Schaltgetriebe sequentiell / Sequential Manual Transmission (54) mit Sensor / with sensor (92) Füllmedium: Mineralöl / Fill Medium: Mineral Oil (24) Immer erneuern / Renew everytime (28)
				1863 869 012	28	Nadellager / Needle Bearing (47)
		OM611.987, OM611.981, OM612.981		6284 600 573		
210 D 212 D	01.97 - 04.00 02.95 - 04.00	OM602LA		3000 951 785  3082 269 031  1878 600 501  3151 248 031	250 26 M250 250CD KZIS-0	
				3000 725 001 ●  3082 269 031  1864 504 031  3151 248 031	250 26 M250 250B KZIS-0	
				2294 000 525	250 250	
			1863 869 010	35	Nadellager / Needle Bearing (47)	
			6283 600 115			
		OM602.980		1863 869 010	35	Nadellager / Needle Bearing (47)

SPRINTER 2-t Pritsche / Flatbed (901, 902) 01.95 - 05.06

214	02.95 - 05.06	M111.979		3000 826 901  3082 268 031  1878 994 001  3151 248 031	240 26 M240 240TB KZIS-0	
				1863 869 010	35	Nadellager / Needle Bearing (47)
				6283 600 115		
				6284 600 573		
		M111.984		3000 990 218 	240 26	XTend Kit plus CSC ->Chass. A920787 ->Chass. R636764 Nabenprofil / Hub Profile: 26,5x29-26N (46) für Schwungradtiefe [mm] / for flywheel depth [mm]: 8 (84)
		3000 990 252 	240 26	XTend Kit plus CSC Nabenprofil / Hub Profile: 26,5x29-26N (46) für Schwungradtiefe [mm] / for flywheel depth [mm]: 12 (84) Nur zusammen verbauen / Only install together (51)		
		3182 997 804 	HHAS-1	Immer erneuern / Renew everytime (28)		
		3182 997 802	HHAS-1	Schaltgetriebe sequentiell / Sequential Manual Transmission (54) mit Sensor / with sensor (92) Füllmedium: Mineralöl / Fill Medium: Mineral Oil (24) Immer erneuern / Renew everytime (28)		

		CODE				
--	--	------	--	---	---	---





MERCEDES-BENZ

SPRINTER 2-t Pritsche / Flatbed (901, 902) 01.95 - 05.06						
214 NGT	04.00 - 05.06	M111.984		3000 990 218 	240 26	XTend Kit plus CSC ->Chass. A920787 ->Chass. R636764 Nabenprofil / Hub Profile: 26,5x29-26N (46) für Schwungradtiefe [mm] / for flywheel depth [mm]: 8 (84)
				3000 990 252 	240 26	XTend Kit plus CSC Nabenprofil / Hub Profile: 26,5x29-26N (46) für Schwungradtiefe [mm] / for flywheel depth [mm]: 12 (84) Nur zusammen verbauen / Only install together (51)
				3182 997 804 	HHAS-1	Immer erneuern / Renew everytime (28)
				3182 997 802	HHAS-1	Schaltgetriebe sequentiell / Sequential Manual Transmission (54) mit Sensor / with sensor (92) Füllmedium: Mineralöl / Fill Medium: Mineral Oil (24) Immer erneuern / Renew everytime (28)
208 CDI 211 CDI 213 CDI 216 CDI	04.00 - 05.06	OM611.981/987, OM612.981		2290 601 011 	240 26	ZMS Modul XTend plus CSC Montageart: nicht vormontiert / Mounting Type: not pre-mounted (43) Beinhaltet ZMS, Kupplungsdruckplatte, Kupplungsscheibe und CSC / Contains twin-mass flywheel, clutch cover assembly, clutch disc and CSC (16) enthält Schwungradbefestigungsschrauben / includes bolt for flywheel mounting (65)
				3000 990 218 	240 26	XTend Kit plus CSC ->Chass. A920787 ->Chass. R636764 Nabenprofil / Hub Profile: 26,5x29-26N (46) für Schwungradtiefe [mm] / for flywheel depth [mm]: 8 (84)
				3000 990 252 	240 26	XTend Kit plus CSC Nabenprofil / Hub Profile: 26,5x29-26N (46) für Schwungradtiefe [mm] / for flywheel depth [mm]: 12 (84) Nur zusammen verbauen / Only install together (51)
				3182 997 802	HHAS-1	Schaltgetriebe sequentiell / Sequential Manual Transmission (54) mit Sensor / with sensor (92) Füllmedium: Mineralöl / Fill Medium: Mineral Oil (24) Immer erneuern / Renew everytime (28)
				1863 869 012	28	Nadellager / Needle Bearing (47)
				6284 600 573		
				OM611.987, OM611.981, OM612.981		
208 D, 58 kW	01.95 - 04.00	OM601.943		3000 726 001  3082 267 233  1864 503 231  3151 248 031	228 26 M228X 228B KZIS-0	
				2294 000 767	240	enthält Schwungradbefestigungsschrauben / includes bolt for flywheel mounting (65)
				1863 869 010	35	Nadellager / Needle Bearing (47)
				6283 600 115		02.1995->
208 D, 60 kW	09.96 - 04.00	OM601.943		 2294 000 767  3082 267 233  1864 503 231  3151 248 031  1874 000 006	228 26 M228X 228B KZIS-0	ZMS Modul Montageart: nicht vormontiert / Mounting Type: not pre-mounted (43) Beinhaltet ZMS, Kupplungsdruckplatte, Kupplungsscheibe und Ausrücker / Contains twin-mass flywheel, clutch cover assembly, clutch disc and releaser (15) enthält Schwungradbefestigungsschrauben / includes bolt for flywheel mounting (65)
				1863 869 010	35	Nadellager / Needle Bearing (47)
				6283 600 115		























		CODE					
--	--	------	--	--	---	---	---

MERCEDES-BENZ

SPRINTER 2-t Pritsche / Flatbed (901, 902) 01.95 - 05.06

210 D 212 D	01.97 - 04.00 02.95 - 04.00	OM602LA		3000 951 785 ⊗ 3082 269 031 ⊗ 1878 600 501 ⊙ 3151 248 031	250 26 M250 250CD KZIS-0		
				3000 725 001 ● ⊗ 3082 269 031 ⊗ 1864 504 031 ⊙ 3151 248 031	250 26 M250 250B KZIS-0		
				2294 000 525	250 250		
	OM602.980		1863 869 010	35	Nadellager / Needle Bearing	(47)	
			6283 600 115				



















SPRINTER 3-t Kasten / Box (903) 01.95 - 05.06

314 314 4x4	02.95 - 05.06 08.02 - 05.06	M111.979		3000 826 901 ⊗ 3082 268 031 ⊗ 1878 994 001 ⊙ 3151 248 031	240 26 M240 240TB KZIS-0			
				1863 869 010	35	Nadellager / Needle Bearing	(47)	
	M111.984				3000 990 218 	240 26	XTend Kit plus CSC ->Chass. A920787 ->Chass. R636764 Nabenprofil / Hub Profile: 26,5x29-26N für Schwungradtiefe [mm] / for flywheel depth [mm]: 8	(46) (84)
					3000 990 252 	240 26	XTend Kit plus CSC Nabenprofil / Hub Profile: 26,5x29-26N für Schwungradtiefe [mm] / for flywheel depth [mm]: 12 Nur zusammen verbauen / Only install together	(46) (84) (51)
					3182 997 804 	HHAS-1	Immer erneuern / Renew everytime	(28)
					3182 997 802	HHAS-1	Schaltgetriebe sequentiell / Sequential Manual Transmission mit Sensor / with sensor Füllmedium: Mineralöl / Fill Medium: Mineral Oil Immer erneuern / Renew everytime	(54) (92) (24) (28)
	M111.979, M111.984				6283 600 115			
					6284 600 573			
	314 NGT	04.00 - 05.06			6283 600 115			
					6284 600 573			
308 CDI 311 CDI 311 CDI 4x4 313 CDI 313 CDI 4x4 316 CDI 316 CDI 4x4	04.00 - 05.06 04.00 - 05.06 08.02 - 05.06 04.00 - 05.06 08.02 - 05.06 04.00 - 05.06 08.02 - 05.06	OM611.981/987, OM612.981		2290 601 011 	240 26	ZMS Modul XTend plus CSC Montageart: nicht vormontiert / Mounting Type: not pre-mounted Beinhaltet ZMS, Kupplungsdruckplatte, Kupplungsscheibe und CSC / Contains twin-mass flywheel, clutch cover assembly, clutch disc and CSC enthält Schwungradbefestigungsschrauben / includes bolt for flywheel mounting	(43) (16) (65)	
				3000 990 218 	240 26	XTend Kit plus CSC ->Chass. A920787 ->Chass. R636764 Nabenprofil / Hub Profile: 26,5x29-26N für Schwungradtiefe [mm] / for flywheel depth [mm]: 8	(46) (84)	
		3000 990 252 	240 26	XTend Kit plus CSC Nabenprofil / Hub Profile: 26,5x29-26N für Schwungradtiefe [mm] / for flywheel depth [mm]: 12 Nur zusammen verbauen / Only install together	(46) (84) (51)			
		3182 997 802	HHAS-1	Schaltgetriebe sequentiell / Sequential Manual Transmission mit Sensor / with sensor Füllmedium: Mineralöl / Fill Medium: Mineral Oil Immer erneuern / Renew everytime	(54) (92) (24) (28)			
		1863 869 012	28	Nadellager / Needle Bearing	(47)			
		6284 600 573						
	OM611.987, OM611.981, OM612.981							



























		CODE				
--	--	------	--	---	---	---

MERCEDES-BENZ

SPRINTER 3-t Kasten / Box (903) 01.95 - 05.06

308 D 2.3, 58 kW 308 D 2.3, 60 kW	02.95 - 04.00 02.95 - 04.00	OM601.943		2290 601 007  2294 000 767  3082 267 233  1864 503 231  3151 248 031  1874 000 006	228 26 M228X 228B KZIS-0	ZMS Modul Montageart: nicht vormontiert / Mounting Type: not pre-mounted Beinhaltet ZMS, Kupplungsdruckplatte, Kupplungsscheibe und Ausrücker / Contains twin-mass flywheel, clutch cover assembly, clutch disc and releaser enthält Schwungradbefestigungsschrauben / includes bolt for flywheel mounting	(43)		
				1863 869 010			35	Nadellager / Needle Bearing	(47)
				6283 600 115					
310 D 2.9 312 D 2.9	02.95 - 04.00 02.95 - 04.00	OM602LA		3000 951 785  3082 269 031  1878 600 501  3151 248 031	250 26 M250 250CD KZIS-0				
				3000 725 001 ●				250 26 M250 250B KZIS-0	
				2294 000 525				250 250	
			OM602.980		1863 869 010	35	Nadellager / Needle Bearing	(47)	
			6283 600 115						
312 D 2.9 4x4	05.97 - 08.02	OM602.980		2294 000 525	250 250				
				6283 600 115					



































SPRINTER 3-t Kasten / Box (906) 06.06 -

216 (906.613)	09.08 -	M271.951		3000 990 144   3000 951 188  3182 997 804	240 26 HHAS-1	XTend Kit plus CSC Nabenprofil / Hub Profile: 26x29-26N	(46)		
				6284 605 004					
209 CDI (906.611, 906.613) 211 CDI (906.611, 906.613) 213 CDI (906.611, 906.613) 215 CDI (906.611, 906.613)	06.06 - 06.06 - 06.06 - 06.06 -	OM646.984, OM646.990, OM646.989, OM646.986, OM646.985		2290 601 018   3000 951 188  2294 000 835  3182 997 804  1874 000 006	240 26 HHAS-1	ZMS Modul XTend plus CSC Montageart: nicht vormontiert / Mounting Type: not pre-mounted Beinhaltet ZMS, Kupplungsdruckplatte, Kupplungsscheibe und CSC / Contains twin-mass flywheel, clutch cover assembly, clutch disc and CSC enthält Schwungradbefestigungsschrauben / includes bolt for flywheel mounting	(43)		
				3000 990 144   3000 951 188  3182 997 804			240 26 HHAS-1	XTend Kit plus CSC Nabenprofil / Hub Profile: 26x29-26N	(46)
				6284 605 004					
				2294 000 994			240 240	enthält Schwungradbefestigungsschrauben / includes bolt for flywheel mounting	(65)
			6284 605 004						
210 CDI (906.611, 906.613) 216 CDI (906.611, 906.613)	03.09 - 03.09 -	OM651.957, OM651.955		3000 990 287   2294 000 994	240	XTend Kit plus CSC			
				6284 605 004					
218 CDI (906.611, 906.613) 219 CDI / BlueTEC (906.611, 906.613)	06.06 - 03.09 -	OM642.896, OM642.992		3000 990 195   3000 951 824  3182 997 804	260 26 HHAS-1	XTend Kit plus CSC			
				6284 605 004					

		CODE				
--	--	------	--	---	---	---











MERCEDES-BENZ

























SPRINTER 3-t Pritsche / Flatbed (903) 01.95 - 05.06

























314 314 4x4	02.95 - 05.06 08.02 - 05.06	M111.979	 3000 826 901	240 26 M240 240TB KZIS-0					
			 3082 268 031  1878 994 001  3151 248 031						
	 1863 869 010	35		Nadellager / Needle Bearing	(47)				
	M111.984	 3000 990 218 	240 26	XTend Kit plus CSC ->Chass. A920787 ->Chass. R636764 Nabenprofil / Hub Profile: 26,5x29-26N für Schwungradtiefe [mm] / for flywheel depth [mm]: 8	(46) (84)				
		 3000 990 252 	240 26	XTend Kit plus CSC Nabenprofil / Hub Profile: 26,5x29-26N für Schwungradtiefe [mm] / for flywheel depth [mm]: 12 Nur zusammen verbauen / Only install together	(46) (84) (51)				
		 3182 997 804 	HHAS-1	Immer erneuern / Renew everytime	(28)				
		 3182 997 802	HHAS-1	Schaltgetriebe sequentiell / Sequential Manual Transmission mit Sensor / with sensor Füllmedium: Mineralöl / Fill Medium: Mineral Oil Immer erneuern / Renew everytime	(54) (92) (24) (28)				
 6283 600 115									
 6284 600 573									
314 NGT	04.00 - 05.06		 6283 600 115						
			 6284 600 573						
308 CDI 311 CDI 311 CDI 4x4 313 CDI 313 CDI 4x4 316 CDI 316 CDI 4x4	04.00 - 05.06 04.00 - 05.06 08.02 - 05.06 04.00 - 05.06 08.02 - 05.06 04.00 - 05.06 08.02 - 05.06	OM611.981/987, OM612.981	 2290 601 011 	240 26	ZMS Modul XTend plus CSC Montageart: nicht vormontiert / Mounting Type: not pre-mounted Beinhaltet ZMS, Kupplungsdruckplatte, Kupplungsscheibe und CSC / Contains twin-mass flywheel, clutch cover assembly, clutch disc and CSC enthält Schwungradbefestigungsschrauben / includes bolt for flywheel mounting	(43) (16) (65)			
			 3000 990 218 				240 26	XTend Kit plus CSC ->Chass. A920787 ->Chass. R636764 Nabenprofil / Hub Profile: 26,5x29-26N für Schwungradtiefe [mm] / for flywheel depth [mm]: 8	(46) (84)
			 3000 990 252 				240 26	XTend Kit plus CSC Nabenprofil / Hub Profile: 26,5x29-26N für Schwungradtiefe [mm] / for flywheel depth [mm]: 12 Nur zusammen verbauen / Only install together	(46) (84) (51)
			 3182 997 804 				HHAS-1	Immer erneuern / Renew everytime	(28)
			 3182 997 802				HHAS-1	Schaltgetriebe sequentiell / Sequential Manual Transmission mit Sensor / with sensor Füllmedium: Mineralöl / Fill Medium: Mineral Oil Immer erneuern / Renew everytime	(54) (92) (24) (28)
			 1863 869 012				28	Nadellager / Needle Bearing	(47)
			 6284 600 573						
308 D 2.3, 58 kW 308 D 2.3, 60 kW	02.95 - 04.00 11.96 - 04.00	OM601.943	 2290 601 007	228 26 M228X 228B KZIS-0	ZMS Modul Montageart: nicht vormontiert / Mounting Type: not pre-mounted Beinhaltet ZMS, Kupplungsdruckplatte, Kupplungsscheibe und Ausrücker / Contains twin-mass flywheel, clutch cover assembly, clutch disc and releaser enthält Schwungradbefestigungsschrauben / includes bolt for flywheel mounting	(43) (15) (65)			
			 2294 000 767  3082 267 233  1864 503 231  3151 248 031  1874 000 006						
			 1863 869 010				35	Nadellager / Needle Bearing	(47)
			 6283 600 115						

		CODE				
--	--	------	--	---	---	---

MERCEDES-BENZ



SPRINTER 3-t Pritsche / Flatbed (903) 01.95 - 05.06						
310 D 2.9	01.97 - 04.00	OM602LA		3000 951 785  3082 269 031  1878 600 501  3151 248 031	250 26 M250 250CD KZIS-0	
312 D 2.9	02.95 - 04.00			3000 725 001 ●  3082 269 031  1864 504 031  3151 248 031	250 26 M250 250B KZIS-0	
				2294 000 525	250 250	
		OM602.980		1863 869 010	35	Nadellager / Needle Bearing (47)
				6283 600 115		















SPRINTER 3-t Pritsche / Flatbed (906) 06.06 -						
216 (906.113, 906.213)	09.08 -	M271.951		3000 951 188  	240 26	XTend Nabenprofil / Hub Profile: 26x29-26N (46)
				3182 997 804 	HHAS-1	Immer erneuern / Renew everytime (28)
				6284 605 004		
209 CDI (906.111, 906.113, 906.211, 906.213)	06.06 -	OM646.984, OM646.990, OM646.989, OM646.986, OM646.985		2290 601 018  	240 26	ZMS Modul XTend plus CSC Montageart: nicht vormontiert / Mounting Type: not pre-mounted (43)
211 CDI (906.111, 906.113, 906.211, 906.213)	06.06 -			3000 951 188  2294 000 835  3182 997 804  1874 000 006	HHAS-1	Beinhaltet ZMS, Kupplungsdruckplatte, Kupplungsscheibe und CSC / Contains twin-mass flywheel, clutch cover assembly, clutch disc and CSC (16)
213 CDI (906.111, 906.113, 906.211, 906.213)	06.06 -					enthält Schwungradbefestigungsschrauben / includes bolt for flywheel mounting (65)
215 CDI (906.111, 906.113, 906.211, 906.213)	06.06 -			6284 605 004		
210 CDI (906.111, 906.113, 906.211, 906.213)	03.09 -		OM651.956, OM651.957, OM651.955		3000 990 287  	240
213 CDI (906.111, 906.113, 906.211, 906.213)	03.09 -			2294 000 994	240 240	enthält Schwungradbefestigungsschrauben / includes bolt for flywheel mounting (65)
216 CDI (906.111, 906.113, 906.211, 906.213)	03.09 -			6284 605 004		
218 CDI (906.111, 906.113, 906.211, 906.213)	06.06 -	OM642.993, OM642.896, OM642.992		3000 990 195 	260 26	XTend Kit plus CSC
219 CDI / BlueTEC (906.111, 906.113, 906.211, 906.213)	03.09 -			3000 951 824  3182 997 804	HHAS-1	
				6284 605 004		













SPRINTER 3,5-t Kasten / Box (906) 06.06 -							
316 (906.663, 906.635)	09.08 -	M271.951		3000 990 144 	240 26	XTend Kit plus CSC	
316 NGT (906.633, 906.635)	09.08 -			3000 951 188  3182 997 804	HHAS-1	Nabenprofil / Hub Profile: 26x29-26N (46)	
				6284 605 004			
309 CDI (906.631, 906.633, 906.635, 906.637)	06.06 -	OM646		2290 601 018  	240 26	ZMS Modul XTend plus CSC Montageart: nicht vormontiert / Mounting Type: not pre-mounted (43)	
310 CDI (906.631, 906.633, 906.635, 906.637)	03.09 -			3000 951 188  2294 000 835  3182 997 804  1874 000 006	HHAS-1	Beinhaltet ZMS, Kupplungsdruckplatte, Kupplungsscheibe und CSC / Contains twin-mass flywheel, clutch cover assembly, clutch disc and CSC (16)	
311 CDI (906.631, 906.633, 906.635, 906.637)	06.06 -					enthält Schwungradbefestigungsschrauben / includes bolt for flywheel mounting (65)	
311 CDI 4x4 (906.631, 906.633, 906.635, 906.637)	02.08 -			6284 605 004			
313 CDI (906.631, 906.633, 906.635, 906.637)	06.06 -		OM651		3000 990 144 	240 26	XTend Kit plus CSC
315 CDI (906.631, 906.633, 906.635, 906.637)	06.06 -				3000 951 188  3182 997 804	HHAS-1	Nabenprofil / Hub Profile: 26x29-26N (46)
					6284 605 004		
315 CDI 4x4 (906.631, 906.633, 906.635, 906.637)	02.08 -			3000 990 287  	240	XTend Kit plus CSC	
315 CDI 4x4 (906.631, 906.633, 906.635, 906.637)	02.08 -			2294 000 994	240 240	enthält Schwungradbefestigungsschrauben / includes bolt for flywheel mounting (65)	
316 CDI (906.631, 906.633, 906.635, 906.637)	03.09 -		6284 605 004				
316 CDI 4x4 (906.631, 906.633, 906.635, 906.637)	03.09 -						

		CODE				
--	--	------	--	---	---	---

MERCEDES-BENZ





















































SPRINTER 3,5-t Kasten / Box (906) 06.06 -							
318 CDI (906.631, 906.633, 906.635, 906.637)	06.06-	OM642.993, OM642.896, OM642.992, OM642.898		3000 990 195  3000 951 824 3182 997 804	260 26 HHAS-1	XTend Kit plus CSC	
318 CDI 4x4 (906.631, 906.633, 906.635, 906.637)	02.08-			6284 605 004			
319 CDI / BlueTEC (906.631, 906.633, 906.635, 906.637)	03.09-						
319 CDI / BlueTEC 4x4 (906.631, 906.633, 906.635, 906.637)	03.09-						

SPRINTER 3,5-t Pritsche / Flatbed (906) 06.06 -								
316 (906.133, 906.135, 906.233, 906.235)	09.08-	M271.951		3000 990 144  3000 951 188 3182 997 804	240 26 HHAS-1	XTend Kit plus CSC Nabenprofil / Hub Profile: 26x29-26N	(46)	
316 NGT (906.133, 906.135, 906.233, 906.235)	09.08-			6284 605 004				
309 CDI (906.131, 906.133, 906.135, 906.231, 906.233...)	06.06-	OM646		2290 601 018  3000 951 188 2294 000 835 3182 997 804 1874 000 006	240 26 HHAS-1	ZMS Modul XTend plus CSC Montageart: nicht vormontiert / Mounting Type: not pre-mounted Beinhaltet ZMS, Kupplungsdruckplatte, Kupplungsscheibe und CSC / Contains twin-mass flywheel, clutch cover assembly, clutch disc and CSC	(43) (16)	
310 CDI (906.131, 906.133, 906.135, 906.231, 906.233...)	03.09-						enthält Schwungradbefestigungsschrauben / includes bolt for flywheel mounting (65)	
311 CDI (906.131, 906.133, 906.135, 906.231, 906.233...)	06.06-							
311 CDI 4x4 (906.131, 906.133, 906.135, 906.231...)	02.08-							
313 CDI (906.131, 906.133, 906.135, 906.231, 906.233...)	06.06-				3000 990 144  3000 951 188 3182 997 804	240 26 HHAS-1	XTend Kit plus CSC Nabenprofil / Hub Profile: 26x29-26N	(46)
313 CDI 4x4 (906.131, 906.133, 906.135, 906.231...)	06.06-				6284 605 004			
315 CDI (906.131, 906.133, 906.135, 906.231, 906.233...)	06.06-		OM651		3000 990 287  2294 000 994	240 240	enthält Schwungradbefestigungsschrauben / includes bolt for flywheel mounting (65)	
315 CDI 4x4 (906.131, 906.133, 906.135, 906.231...)	02.08-					6284 605 004		
316 CDI (906.131, 906.133, 906.135, 906.231, 906.233...)	03.09-							
316 CDI 4x4 (906.131, 906.133, 906.135, 906.231...)	03.09-							
318 CDI (906.131, 906.133, 906.135, 906.231, 906.233...)	06.06-				3000 990 195  3000 951 824 3182 997 804	260 26 HHAS-1	XTend Kit plus CSC	
318 CDI 4x4 (906.131, 906.133, 906.135, 906.231...)	02.08-			6284 605 004				

SPRINTER 4-t Kasten / Box (904) 02.96 - 05.06								
414	02.96-05.06	M111.979		3000 826 901 3082 268 031 1878 994 001 3151 248 031	240 26 M240 240TB KZIS-0			
414 4x4	05.97-05.06			3000 951 785 3082 269 031 1878 600 501 3151 248 031	250 26 M250 250CD KZIS-0	für / for: SA 504097/03 für / for: SA 504096/03 für Motoren ohne Zweimassenschwungrad / for engines without dual-mass flywheel	(68) (68) (81)	
				1863 869 010	35	Nadellager / Needle Bearing	(47)	
				6283 600 115				
				6284 600 573				
			M111.984		3000 990 218  ->Chass. A920787 ->Chass. R636764	240 26	XTend Kit plus CSC Nabenprofil / Hub Profile: 26,5x29-26N für Schwungradtiefe [mm] / for flywheel depth [mm]: 8	(46) (84)
					3000 990 252  Nur zusammen verbauen / Only install together	240 26	XTend Kit plus CSC Nabenprofil / Hub Profile: 26,5x29-26N für Schwungradtiefe [mm] / for flywheel depth [mm]: 12	(46) (84) (51)
				3182 997 804 	HHAS-1	Immer erneuern / Renew everytime	(28)	
			3182 997 802	HHAS-1	Schaltgetriebe sequentiell / Sequential Manual Transmission mit Sensor / with sensor	(54) (92)		

		CODE				
--	--	------	--	---	---	---



































MERCEDES-BENZ

SPRINTER 4-t Kasten / Box (904) 02.96 - 05.06						
408 D	02.96 - 05.06	OM601.943	 2290 601 007  2294 000 767  3082 267 233  1864 503 231  3151 248 031  1874 000 006	228 26 M228X 228B KZIS-0	ZMS Modul Montageart: nicht vormontiert / Mounting Type: not pre-mounted Beinhaltet ZMS, Kupplungsdruckplatte, Kupplungsscheibe und Ausrücker / Contains twin-mass flywheel, clutch cover assembly, clutch disc and releaser enthält Schwungradbefestigungsschrauben / includes bolt for flywheel mounting	(43) (15) (65)
			 3000 951 785  3082 269 031  1878 600 501  3151 248 031	250 26 M250 250CD KZIS-0	für / for: SA 504097/03 für / for: SA 504096/03	(68) (68)
			 3000 726 001  3082 267 233  1864 503 231  3151 248 031	228 26 M228X 228B KZIS-0		
			 1863 869 010	35	Nadellager / Needle Bearing	(47)
			 6283 600 115			
408 CDI 411 CDI 411 CDI 4x4 413 CDI 413 CDI 4x4 416 CDI 416 CDI 4x4	04.00 - 05.06	OM611.981/987, OM612.981	 2290 601 011  	240 26	ZMS Modul XTend plus CSC Montageart: nicht vormontiert / Mounting Type: not pre-mounted Beinhaltet ZMS, Kupplungsdruckplatte, Kupplungsscheibe und CSC / Contains twin-mass flywheel, clutch cover assembly, clutch disc and CSC enthält Schwungradbefestigungsschrauben / includes bolt for flywheel mounting	(43) (16) (65)
			 3000 990 218  	240 26	XTend Kit plus CSC ->Chass. A920787 ->Chass. R636764 Nabenprofil / Hub Profile: 26,5x29-26N für Schwungradtiefe [mm] / for flywheel depth [mm]: 8	(46) (84)
			 3000 990 252  	240 26	XTend Kit plus CSC Nabenprofil / Hub Profile: 26,5x29-26N für Schwungradtiefe [mm] / for flywheel depth [mm]: 12 Nur zusammen verbauen / Only install together	(46) (84) (51)
			 3182 997 802	HHAS-1	Schaltgetriebe sequentiell / Sequential Manual Transmission mit Sensor / with sensor Füllmedium: Mineralöl / Fill Medium: Mineral Oil Immer erneuern / Renew everytime	(54) (92) (24) (28)
			 3182 997 804 	HHAS-1	Immer erneuern / Renew everytime	(28)
			 1863 869 012	28	Nadellager / Needle Bearing	(47)
			 6284 600 573			
410 D 410 D 4x4 412 D, 85 kW 412 D 4x4, 85 kW	02.96 - 05.06 05.97 - 05.06 02.96 - 05.06 05.97 - 05.06	OM602LA	 3000 951 785  3082 269 031  1878 600 501  3151 248 031	250 26 M250 250CD KZIS-0		
			 3000 725 001 ●  3082 269 031  1864 504 031  3151 248 031	250 26 M250 250B KZIS-0		
			 2294 000 525	250 250		
		OM602.980	 1863 869 010	35	Nadellager / Needle Bearing	(47)
			 6283 600 115			
412 D, 90 kW 412 D 4x4, 90 kW	02.96 - 05.06 05.97 - 05.06	OM602LA	 3000 951 785  3082 269 031  1878 600 501  3151 248 031	250 26 M250 250CD KZIS-0		
			 3000 725 001 ●  3082 269 031  1864 504 031  3151 248 031	250 26 M250 250B KZIS-0		
			 2294 000 525	250 250		
		OM602.980	 1863 869 010	35	Nadellager / Needle Bearing	(47)
			 6283 600 115			

		CODE				
--	--	------	--	---	---	---

MERCEDES-BENZ











SPRINTER 4-t Pritsche / Flatbed (904) 02.96 - 05.06

414 414 4x4	02.96 - 05.06 05.97 - 05.06	M111.979	 3000 826 901	240 26		
			 3082 268 031	M240		
			 1878 994 001	240TB		
			 3151 248 031	KZIS-0		
			 3000 951 785	250 26	für / for: SA 504097/03	(68)
	 3082 269 031	M250	für / for: SA 504096/03	(68)		
	 1878 600 501	250CD	für Motoren ohne Zweimassenschwungrad / for engines without dual-mass flywheel	(81)		
	 3151 248 031	KZIS-0				
	 1863 869 010	35	Nadellager / Needle Bearing	(47)		
	 6283 600 115					
 6284 600 573						
		M111.984	 3000 990 218 	240 26	XTend Kit plus CSC ->Chass. A920787 ->Chass. R636764	
					Nabenprofil / Hub Profile: 26,5x29-26N	(46)
					für Schwungradtiefe [mm] / for flywheel depth [mm]: 8	(84)
			 3000 990 252 	240 26	XTend Kit plus CSC	(46)
					Nabenprofil / Hub Profile: 26,5x29-26N	(84)
		für Schwungradtiefe [mm] / for flywheel depth [mm]: 12				
		Nur zusammen verbauen / Only install together	(51)			
 3182 997 804 	HHAS-1	Immer erneuern / Renew everytime	(28)			
 3182 997 802	HHAS-1	Schaltgetriebe sequentiell / Sequential Manual Transmission	(54)			
		mit Sensor / with sensor	(92)			
		Füllmedium: Mineralöl / Fill Medium: Mineral Oil	(24)			
		Immer erneuern / Renew everytime	(28)			
408 D	02.96 - 05.06	OM601.943	 3000 951 785	250 26	für / for: SA 504097/03	(68)
			 3082 269 031	M250	für / for: SA 504096/03	(68)
			 1878 600 501	250CD	für Motoren mit Zweimassenschwungrad / for engines with dual-mass flywheel	(80)
			 3151 248 031	KZIS-0		
 2294 000 767	240	enthält Schwungradbefestigungsschrauben / includes bolt for flyweel mounting	(65)			
 6283 600 115						
408 CDI 411 CDI 411 CDI 4x4 413 CDI 413 CDI 4x4 416 CDI 416 CDI 4x4	04.00 - 05.06 04.00 - 05.06 04.00 - 05.06 04.00 - 05.06 04.00 - 05.06 04.00 - 05.06 04.00 - 05.06	OM611.981/987, OM612.981	 2290 601 011 	240 26	ZMS Modul XTend plus CSC	(43)
					Montageart: nicht vormontiert / Mounting Type: not pre-mounted	(16)
					Beinhaltet ZMS, Kupplungsdruckplatte, Kupplungsscheibe und CSC / Contains twin-mass flywheel, clutch cover assembly, clutch disc and CSC	(65)
					enthält Schwungradbefestigungsschrauben / includes bolt for flyweel mounting	
			 3000 990 218 	240 26	XTend Kit plus CSC ->Chass. A920787 ->Chass. R636764	(46)
					Nabenprofil / Hub Profile: 26,5x29-26N	(84)
					für Schwungradtiefe [mm] / for flywheel depth [mm]: 8	
			 3000 990 252 	240 26	XTend Kit plus CSC	(46)
					Nabenprofil / Hub Profile: 26,5x29-26N	(84)
					für Schwungradtiefe [mm] / for flywheel depth [mm]: 12	
					Nur zusammen verbauen / Only install together	(51)
			 3182 997 804 	HHAS-1	Immer erneuern / Renew everytime	(28)
 3182 997 802	HHAS-1	Schaltgetriebe sequentiell / Sequential Manual Transmission	(54)			
		mit Sensor / with sensor	(92)			
		Füllmedium: Mineralöl / Fill Medium: Mineral Oil	(24)			
		Immer erneuern / Renew everytime	(28)			
 1863 869 012	28	Nadellager / Needle Bearing	(47)			
 6284 600 573						
		OM611.987, OM611.981, OM612.981				



















		CODE				
--	--	------	--	---	---	---

MERCEDES-BENZ



















SPRINTER 4-t Pritsche / Flatbed (904) 02.96 - 05.06

410 D	02.96 - 05.06	OM602LA		3000 951 785  3082 269 031  1878 600 501  3151 248 031	250 26 M250 250CD KZIS-0			
410 D 4x4	05.97 - 05.06							
412 D, 85 kW	02.96 - 05.06							
412 D 4x4, 85 kW	05.97 - 05.06				3000 725 001 ●  3082 269 031  1864 504 031  3151 248 031	250 26 M250 250B KZIS-0		
412 D, 90 kW	02.96 - 05.06							
412 D 4x4, 90 kW	05.97 - 05.06			2294 000 525	250 250			
				1863 869 010	35	Nadellager / Needle Bearing	(47)	
		OM602.980		6283 600 115				

SPRINTER 4,6-t Kasten / Box (906) 06.06 -

























413 CDI (906.653, 906.655, 906.657)	06.06 -	OM646		2290 601 018   3000 951 188  2294 000 835  3182 997 804  1874 000 006	240 26 HHAS-1	ZMS Modul XTend plus CSC Montageart: nicht vormontiert / Mounting Type: not pre-mounted Beinhaltet ZMS, Kupplungsdruckplatte, Kupplungsscheibe und CSC / Contains twin-mass flywheel, clutch cover assembly, clutch disc and CSC enthält Schwungradbefestigungsschrauben / includes bolt for flywheel mounting	(43) (16) (65)	
416 CDI (906.653, 906.655, 906.657)	03.09 -				3000 990 144   3000 951 188  3182 997 804	240 26 HHAS-1	XTend Kit plus CSC Nabenprofil / Hub Profile: 26x29-26N	(46)
					6284 605 004			
			OM651		3000 990 287   2294 000 994	240 240	XTend Kit plus CSC enthält Schwungradbefestigungsschrauben / includes bolt for flywheel mounting	(65)
419 CDI (906.653, 906.655, 906.657)	03.09 -	OM642.992		3000 990 195   3000 951 824  3182 997 804	260 26 HHAS-1	XTend Kit plus CSC		
					6284 605 004			



















SPRINTER 4,6-t Pritsche / Flatbed (906) 06.06 -































413 CDI (906.153, 906.155, 906.253, 906.255)	06.06 -	OM646		2290 601 018   3000 951 188  2294 000 835  3182 997 804  1874 000 006	240 26 HHAS-1	ZMS Modul XTend plus CSC Montageart: nicht vormontiert / Mounting Type: not pre-mounted Beinhaltet ZMS, Kupplungsdruckplatte, Kupplungsscheibe und CSC / Contains twin-mass flywheel, clutch cover assembly, clutch disc and CSC enthält Schwungradbefestigungsschrauben / includes bolt for flywheel mounting	(43) (16) (65)	
415 CDI (906.153, 906.155, 906.253, 906.255)	06.06 -				3000 990 144   3000 951 188  3182 997 804	240 26 HHAS-1	XTend Kit plus CSC Nabenprofil / Hub Profile: 26x29-26N	(46)
416 CDI (906.153, 906.155, 906.253, 906.255)	03.09 -				6284 605 004			
			OM651		3000 990 287   2294 000 994	240 240	XTend Kit plus CSC enthält Schwungradbefestigungsschrauben / includes bolt for flywheel mounting	(65)
418 CDI (906.153, 906.155, 906.253, 906.255)	06.06 -	OM642.993, OM642.896, OM642.992, OM642.898		3000 990 195   3000 951 824  3182 997 804	260 26 HHAS-1	XTend Kit plus CSC		
419 CDI (906.153, 906.155, 906.253, 906.255)	03.09 -				6284 605 004			

		CODE				
--	--	------	--	---	---	---

MERCEDES-BENZ

SPRINTER 5-t Kasten / Box (906) 06.06 -											
509 CDI (906.653, 906.655, 906.657)	06.06-	OM646		2290 601 018   3000 951 188  2294 000 835  3182 997 804  1874 000 006	240 26 HHAS-1	ZMS Modul XTend plus CSC Montageart: nicht vormontiert / Mounting Type: not pre-mounted Beinhaltet ZMS, Kupplungsdruckplatte, Kupplungsscheibe und CSC / Contains twin-mass flywheel, clutch cover assembly, clutch disc and CSC enthält Schwungradbefestigungsschrauben / includes bolt for flyweel mounting	(43) (16) (65)				
510 CDI (906.653, 906.655, 906.657)	03.09-		OM646		3000 990 144   3000 951 188  3182 997 804	240 26 HHAS-1	XTend Kit plus CSC Nabenprofil / Hub Profile: 26x29-26N	(46)			
511 CDI (906.653, 906.655, 906.657)	06.06-			OM651		3000 990 287 	240	XTend Kit plus CSC			
513 CDI (906.653, 906.655, 906.657)	06.06-				OM651		2294 000 994	240 240	enthält Schwungradbefestigungsschrauben / includes bolt for flyweel mounting	(65)	
515 CDI (906.653, 906.655, 906.657)	06.06-					OM651		6284 605 004			
516 CDI (906.653, 906.655, 906.657)	03.09-						OM651		3000 990 195   3000 951 824  3182 997 804	260 26 HHAS-1	XTend Kit plus CSC
		OM651							6284 605 004		
			OM651						6284 605 004		
				OM651					6284 605 004		
					OM651				6284 605 004		
						OM651			6284 605 004		
							OM651		6284 605 004		









SPRINTER 5t Pritsche / Flatbed (905) 04.01 - 05.06											
616 CDI (905.612, 905.613, 905.622, 905.623)	04.01 - 05.06	OM612.981		2290 601 011   3000 951 188  2294 000 835  3182 997 804	240 26 HHAS-1	ZMS Modul XTend plus CSC Montageart: nicht vormontiert / Mounting Type: not pre-mounted Beinhaltet ZMS, Kupplungsdruckplatte, Kupplungsscheibe und CSC / Contains twin-mass flywheel, clutch cover assembly, clutch disc and CSC enthält Schwungradbefestigungsschrauben / includes bolt for flyweel mounting	(43) (16) (65)				
			OM612.981		3000 990 252   3000 951 188  3182 997 804	240 26 HHAS-1	XTend Kit plus CSC Nabenprofil / Hub Profile: 26,5x29-26N für Schwungradtiefe [mm] / for flywheel depth [mm]: 12 Nur zusammen verbauen / Only install together	(46) (84) (51)			
				OM612.981		3000 990 218   3000 951 188  3182 997 804	240 26 HHAS-1	XTend Kit plus CSC ->Chass. R 636764 Nabenprofil / Hub Profile: 26,5x29-26N für Schwungradtiefe [mm] / for flywheel depth [mm]: 8	(46) (84)		
					OM612.981		3182 997 804 	HHAS-1	Immer erneuern / Renew everytime	(28)	
						OM612.981		1863 869 012	28	Nadellager / Needle Bearing	(47)
							OM612.981		1863 869 012	28	Nadellager / Needle Bearing
		OM612.981							1863 869 012	28	Nadellager / Needle Bearing
			OM612.981						1863 869 012	28	Nadellager / Needle Bearing

SPRINTER 5-t Pritsche / Flatbed (906) 06.06 -											
516 (906.153, 906.155, 906.253, 906.255)	09.08-	M271.951		3000 990 144   3000 951 188  3182 997 804	240 26 HHAS-1	XTend Kit plus CSC Nabenprofil / Hub Profile: 26x29-26N	(46)				
516 NGT (906.153, 906.155, 906.253, 906.255)	09.08-		M271.951		6284 605 004						
509 CDI (906.153, 906.155, 906.253, 906.255)	06.06-	OM646			2290 601 018   3000 951 188  2294 000 835  3182 997 804  1874 000 006	240 26 HHAS-1	ZMS Modul XTend plus CSC Montageart: nicht vormontiert / Mounting Type: not pre-mounted Beinhaltet ZMS, Kupplungsdruckplatte, Kupplungsscheibe und CSC / Contains twin-mass flywheel, clutch cover assembly, clutch disc and CSC enthält Schwungradbefestigungsschrauben / includes bolt for flyweel mounting	(43) (16) (65)			
510 CDI (906.153, 906.155, 906.253, 906.255)	03.09-		OM646		3000 990 144   3000 951 188  3182 997 804	240 26 HHAS-1	XTend Kit plus CSC Nabenprofil / Hub Profile: 26x29-26N	(46)			
511 CDI (906.153, 906.155, 906.253, 906.255)	06.06-			OM651		3000 990 287 	240	XTend Kit plus CSC			
513 CDI (906.135, 906.155, 906.253, 906.255)	06.06-				OM651		2294 000 994	240 240	enthält Schwungradbefestigungsschrauben / includes bolt for flyweel mounting	(65)	
513 CDI 4x4 (906.135, 906.155, 906.253, 906.255)	05.11-					OM651		6284 605 004			
515 CDI (906.153, 906.155, 906.253, 906.255)	06.06-						OM651		3000 990 287 	240	XTend Kit plus CSC
516 CDI (906.153, 906.155, 906.253, 906.255)	03.09-	OM651							2294 000 994	240 240	enthält Schwungradbefestigungsschrauben / includes bolt for flyweel mounting
516 CDI 4x4 (906.153, 906.155, 906.255)	05.11-		OM651						6284 605 004		
518 CDI (906.153, 906.155, 906.253, 906.255)	06.06-			OM642.993, OM642.896, OM642.992, OM642.898					3000 990 195   3000 951 824  3182 997 804	260 26 HHAS-1	XTend Kit plus CSC
519 CDI / BlueTEC (906.153, 906.155, 906.253, 906.255)	03.09-				OM642.993, OM642.896, OM642.992, OM642.898				6284 605 004		
						OM642.993, OM642.896, OM642.992, OM642.898			6284 605 004		
							OM642.993, OM642.896, OM642.992, OM642.898		6284 605 004		
		OM642.993, OM642.896, OM642.992, OM642.898							6284 605 004		
			OM642.993, OM642.896, OM642.992, OM642.898						6284 605 004		
				OM642.993, OM642.896, OM642.992, OM642.898					6284 605 004		













		CODE				
--	--	------	--	---	---	---

MERCEDES-BENZ

SPRINTER Kipper / Dumptruck (905) 04.01 -

616 CDI (905.612, 905.622, 905.623)	04.01 -	OM612.981		2290 601 011 	240 26	ZMS Modul XTend plus CSC Montageart: nicht vormontiert / Mounting Type: not pre-mounted (43) Beinhaltet ZMS, Kupplungsdruckplatte, Kupplungsscheibe und CSC / Contains twin-mass flywheel, clutch cover assembly, clutch disc and CSC (16) enthält Schwungradbefestigungsschrauben / includes bolt for flywheel mounting (65)
				3000 990 252 	240 26	XTend Kit plus CSC Nabenprofil / Hub Profile: 26,5x29-26N für Schwungradtiefe [mm] / for flywheel depth [mm]: 12 (46) Nur zusammen verbauen / Only install together (84) (51)
				3000 990 218 	240 26	XTend Kit plus CSC ->Chass. R 636764 Nabenprofil / Hub Profile: 26,5x29-26N für Schwungradtiefe [mm] / for flywheel depth [mm]: 8 (46) (84)
				3182 997 804 	HHAS-1	Immer erneuern / Renew everytime (28)
				1863 869 012	28	Nadellager / Needle Bearing (47)

T2/L Kipper / Dumptruck 01.68 - 12.88

LK 408 G (309.040, 309.041) LK 408 G, LK 409 (309.040, 309.041, 309.044) LK 408 G, LK 409 (309.041, 309.044)	01.68 - 12.74 01.75 - 08.82 08.82 - 09.83	M115, 121		1878 634 052	228 10 228GSB	->Chass. 145736
				1861 557 236 #	228 10 228GSB	->Chass. 145736
				3082 121 031	228 M228	->Chass. 145736 Nur verbauen, wenn Fahrzeug mit M-Kupplung ausgerüstet ist / Only install if the vehicle is equipped with an M-type clutch (50)
				3151 034 031 ▲	KZI-1	->Chass. 145736 Nur verbauen, wenn Fahrzeug mit M-Kupplung ausgerüstet ist / Only install if the vehicle is equipped with an M-type clutch (50)
				3082 121 031	228 M228	
				1861 557 236 #	228 10 228GSB	->Chass. 556499
				1878 634 052	228 10 228GSB	->Chass. 556499
				3151 034 031 ▲	KZI-1	->Chass. 184086
				3151 000 206	KZIS-1	Chass. 184087->
				1863 869 010	35	Nadellager / Needle Bearing (47)
LKO 508 DG (309.440, 309.441, 309.442, 309.444, 309.445) LKO 508 DG (309.440, 309.441, 309.442, 309.444, 309.445)	09.72 - 06.88 09.72 - 06.88	OM314		1800 125 201 1882 205 234 1861 291 136 3151 044 031	250 10 HBX250 250GTZ KZI-3	Mot. 678175-> 309.440-445
				3151 095 043	KZI-3	->Chass. 145736 LHD ->Chass. 148036 RHD 309.440-445
				3151 033 031	KZI-3	Chass. 145737 LHD - Mot. 678174 LHD Chass. 148037 RHD - Mot. 678174 RHD 309.440-445
L 608 D (310.340, 310.341, 310.342, 310.344, 310.345...) L 608 D (310.340, 310.341, 310.342, 310.344, 310.345...)	02.84 - 12.88 02.84 - 12.88	OM314.961, OM314.948, OM314.946, OM314.963		1800 125 201 1882 205 234 1861 291 136 3151 044 031	250 10 HBX250 250GTZ KZI-3	Mot. 410748-> 310.300-305/311-316/324-329/340-345/400-405 /411-416/424-429/440-445
				3151 095 043	KZI-3	->Chass. 145736 LHD ->Chass. 148036 RHD 310.300-305/311-316/324-329/340-345/400-405 /411-416/424-429/440-445
				3151 033 031	KZI-3	Chass. 145737 - Mot. 410747 310.340-345/400-405/411-416/424-429/440-445 /300-305/311-316/324-329















		CODE				
--	--	------	--	---	---	---

MERCEDES-BENZ











T2/L Kipper / Dumptruck 01.68 - 12.88

LK 911 (328.029) LS 911 (328.024, 328.026, 328.044)	01.72-07.83 01.72-07.83	OM352.911	 1861 919 134	280 10 280GTZ		
			 3151 095 043	KZI-3		
			 1882 201 132 HD	295 GF295		
			 1861 279 133 HD	295 10 295GTZ		
			 3151 095 043 HD	KZI-3		

T2/L Kasten / Box 01.68 - 12.88

























L 408 G (309.012, 309.013, 309.014, 309.015, 309.016...), 55 kW L 408 G (309.012, 309.013, 309.014, 309.015, 309.016...), 55 kW L 408 G (309.012, 309.013, 309.014, 309.015, 309.016...), 63 kW L 408 G (309.012, 309.013, 309.014, 309.015, 309.016...), 63 kW L 409 (309.011, 309.012, 309.013, 309.014, 309.015...) L 410 (309.011, 309.012, 309.013, 309.014, 309.015...)	01.68-12.72 08.72-12.74 01.68-12.72 08.72-12.74 01.75-08.82 08.82-12.88	M115, 121	 1878 634 052	228 10 228GSB	->Chass. 145736				
			 1861 557 236 #	228 10 228GSB	->Chass. 145736				
			 3082 121 031	228 M228	->Chass. 145736 Nur verbauen, wenn Fahrzeug mit M-Kupplung ausgerüstet ist / Only install if the vehicle is equipped with an M-type clutch	(50)			
			 3151 034 031 ▲	KZI-1	->Chass. 145736 Nur verbauen, wenn Fahrzeug mit M-Kupplung ausgerüstet ist / Only install if the vehicle is equipped with an M-type clutch	(50)			
			 3082 121 031	228 M228					
			 1861 557 236 #	228 10 228GSB	->Chass. 556499				
			 1878 634 052	228 10 228GSB	->Chass. 556499				
			 3151 034 031 ▲	KZI-1	->Chass. 184086				
			 3151 000 206	KZIS-1	Chass. 184087->				
			 1863 869 010	35	Nadellager / Needle Bearing	(47)			
			L 405 D	01.72-12.80	OM636, OM621	 1881 059 208	200 KS200	->Chass. 082858	
						 1861 123 236	200 10 200PE	->Chass. 082858	
						 3082 121 031	228 M228	Chass. 082859-> Nur verbauen, wenn Fahrzeug mit M-Kupplung ausgerüstet ist / Only install if the vehicle is equipped with an M-type clutch	(50)
 3151 034 031 ▲	KZI-1	Chass. 082859-> Nur verbauen, wenn Fahrzeug mit M-Kupplung ausgerüstet ist / Only install if the vehicle is equipped with an M-type clutch				(50)			

MERCEDES-BENZ

T2/L Kasten / Box		01.68 - 12.88				
L 406 DG (309.111, 309.112, 309.113, 309.114, 309.115...)	01.68-12.74	OM615, 616, 621	 3082 121 031	228 M228	->Chass. 145736 LHD ->Chass. 148036 RHD Nur verbauen, wenn Fahrzeug mit M-Kupplung ausgerüstet ist / Only install if the vehicle is equipped with an M-type clutch	(50)
			 3151 034 031 ▲	KZI-1	->Chass. 145736 LHD ->Chass. 148036 RHD 309.100-103/111-116/124-126 Nur verbauen, wenn Fahrzeug mit M-Kupplung ausgerüstet ist / Only install if the vehicle is equipped with an M-type clutch	(50)
			 3082 121 031	228 M228	Chass. 145737 LHD - Chass. 182065 LHD Chass. 148037 RHD - Chass. 182065 RHD 309.100-103/111-116/124-126	
			 1878 634 052	228 10 228GSB	Chass. 145737 LHD - Chass. 182065 LHD Chass. 148037 RHD - Chass. 182065 RHD 309.102-103	
			1861 557 236 #	228 10 228GSB	Chass. 145737 LHD - Chass. 182065 LHD Chass. 148037 RHD - Chass. 182065 RHD 309.102-103	
			 3151 034 031 ▲	KZI-1	Chass. 145737 LHD - Chass. 182065 LHD Chass. 148037 RHD - Chass. 182065 RHD 309.100-103/111-116/124-126	
			 3082 121 031	228 M228	Chass. 182066 - Chass. 556499 309.100-103/111-116/124-126	
			 1878 634 052	228 10 228GSB	Chass. 182066 - Chass. 556499 309.102-103	
			1861 557 236 #	228 10 228GSB	Chass. 182066 - Chass. 556499 309.102-103	
			 3151 000 206	KZIS-1	Chass. 182066 - Chass. 556499 309.100-103/111-116/124-126	
			 3082 121 031	228 M228	Chass. 556500-> 309.100-103/111-116/124-126	
			 3151 000 206	KZIS-1	Chass. 556500-> 309.100-103/111-116/124-126	

		CODE				
--	--	------	--	---	---	---









MERCEDES-BENZ

T2/L Kasten / Box		01.68 - 12.88					
L 407 D (309.111, 309.112, 309.113, 309.114, 309.115...), 48 kW L 407 D (309.111, 309.112, 309.113, 309.114, 309.115...), 53 kW	01.75 - 12.88	OM615, 616, 621		3082 121 031	228 M228	->Chass. 145736 LHD ->Chass. 148036 RHD 309.100-103/111-116/124-126 Nur verbauen, wenn Fahrzeug mit M-Kupplung ausgerüstet ist / Only install if the vehicle is equipped with an M-type clutch	(50)
	01.75 - 12.88			3151 034 031 ▲	KZI-1	->Chass. 145736 LHD ->Chass. 148036 RHD 309.100-103/111-116/124-126 Nur verbauen, wenn Fahrzeug mit M-Kupplung ausgerüstet ist / Only install if the vehicle is equipped with an M-type clutch	(50)
				3082 121 031	228 M228	Chass. 145737 LHD - Chass. 182065 LHD Chass. 148037 RHD - Chass. 182065 RHD 309.100-103/111-116/124-126	
				1861 557 236 #	228 10 228GSB	Chass. 145737 LHD - Chass. 182065 LHD Chass. 148037 RHD - Chass. 182065 RHD 309.102-103	
				1878 634 052	228 10 228GSB	Chass. 145737 LHD - Chass. 182065 LHD Chass. 148037 RHD - Chass. 182065 RHD 309.102-103	
				3151 034 031 ▲	KZI-1	Chass. 145737 LHD - Chass. 182065 LHD Chass. 148037 RHD - Chass. 182065 RHD 309.100-103/111-116/124-126	
				3082 121 031	228 M228	Chass. 182066 - Chass. 556499 309.100-103/111-116/124-126	
				1861 557 236 #	228 10 228GSB	Chass. 182066 - Chass. 556499 309.102-103	
				1878 634 052	228 10 228GSB	Chass. 182066 - Chass. 556499 309.102-103	
				3151 000 206	KZIS-1	Chass. 182066 - Chass. 556499 309.100-103/111-116/124-126	
				3082 121 031	228 M228	Chass. 556500-> 309.100-103/111-116/124-126	
				3151 000 206	KZIS-1	Chass. 556500-> 309.100-103/111-116/124-126	
				3082 121 031	228 M228		
				1861 557 236 #	228 10 228GSB		
				1878 634 052	228 10 228GSB		
L 408 DG (309.311, 309.312, 309.313, 309.314, 309.315...)	01.70 - 12.74	OM314		1882 205 234	250 HBX250		
				1861 291 136	250 10 250GTZ		
				3151 095 043	KZI-3	->Chass. 145736 LHD ->Chass. 148036 RHD	
				3151 033 031	KZI-3	Chass. 145737 LHD - Mot. 678174 LHD Chass. 148037 RHD - Mot. 678174 RHD	
				1800 125 201 ⊗ 1882 205 234 ⊗ 1861 291 136 ⊙ 3151 044 031	250 10 HBX250 250GTZ KZI-3	Mot. 678175->	
L 508 DG (309.411, 309.412, 309.413, 309.414, 309.415...), 60 kW L 508 DG (309.411, 309.412, 309.413, 309.414, 309.415...), 63 kW	01.70 - 12.88	OM314		1800 125 201 ⊗ 1882 205 234 ⊗ 1861 291 136 ⊙ 3151 044 031	250 10 HBX250 250GTZ KZI-3	Mot. 678175->	
	01.70 - 12.88			1882 205 234	250 HBX250	->Chass. 145736 LHD ->Chass. 148036 RHD	
				1861 291 136	250 10 250GTZ	->Chass. 145736 LHD ->Chass. 148036 RHD	
				3151 095 043	KZI-3	->Chass. 145736 LHD ->Chass. 148036 RHD	













		CODE				
--	--	------	--	---	---	---

MERCEDES-BENZ

T2/L Kasten / Box 01.68 - 12.88











L 608 D (310.311, 310.312, 310.313, 310.314, 310.315...)	01.70 - 12.88	OM314.948, OM314.967	 1800 125 201  1882 205 234  1861 291 136  3151 044 031	250 10 HBX250 250GTZ KZI-3	Mot. 410748-> 310.300-305/311-316/324-329/340-345/400-405 /411-416/424-429/440-445	
			 3151 095 043	KZI-3	->Chass. 145736 LHD ->Chass. 148036 RHD 310.300-305/311-316/324-329/340-345/400-405 /411-416/424-429/440-445	
			 3151 033 031	KZI-3	Chass. 145737 - Mot. 410747 310.340-345/400-405/411-416/424-429/440-445 /300-305/311-316/324-329	
L 613 D (310.510, 313.424, 313.427, 313.429)	04.77 - 12.88	OM353.963, OM353.966	 1882 317 131	280 HVB280		
			 1861 632 032	280 10 280W2GSZ	->Chass. 346882	
			1861 919 134	280 10 280GTZ	Chass. 346883->	
			 3151 044 031	KZI-3		

T2/L Pritsche / Flatbed 01.68 - 12.88

L 408 G (309.000, 309.001, 309.002, 309.003, 309.011), 55 kW L 408 G (309.000, 309.001, 309.002, 309.003, 309.011), 63 kW L 409 (309.000, 309.001, 309.002, 309.003) L 410 (309.000, 309.002)	08.72 - 12.74	M115, 121	 1878 634 052	228 10 228GSB	->Chass. 145736	
			1861 557 236 #	228 10 228GSB	->Chass. 145736	
	08.72 - 12.74		 3082 121 031	228 M228	->Chass. 145736 Nur verbauen, wenn Fahrzeug mit M-Kupplung ausgerüstet ist / Only install if the vehicle is equipped with an M-type clutch	(50)
	01.75 - 08.82		 3151 034 031 ▲	KZI-1	->Chass. 145736 Nur verbauen, wenn Fahrzeug mit M-Kupplung ausgerüstet ist / Only install if the vehicle is equipped with an M-type clutch	(50)
	08.82 - 12.88		 3082 121 031	228 M228		
			 1861 557 236 #	228 10 228GSB	->Chass. 556499	
			1878 634 052	228 10 228GSB	->Chass. 556499	
			 3151 034 031 ▲	KZI-1	->Chass. 184086	
			 3151 000 206	KZIS-1	Chass. 184087->	
			 1863 869 010	35	Nadellager / Needle Bearing	(47)
L 405 D	01.72 - 12.80	OM636, OM621	 1881 059 208	200 KS200	->Chass. 082858	
			 1861 123 236	200 10 200PE	->Chass. 082858	
			 3082 121 031	228 M228	Chass. 082859-> Nur verbauen, wenn Fahrzeug mit M-Kupplung ausgerüstet ist / Only install if the vehicle is equipped with an M-type clutch	(50)
			 3151 034 031 ▲	KZI-1	Chass. 082859-> Nur verbauen, wenn Fahrzeug mit M-Kupplung ausgerüstet ist / Only install if the vehicle is equipped with an M-type clutch	(50)

























		CODE				
--	--	------	--	---	---	---

MERCEDES-BENZ

T2/L Pritsche / Flatbed		01.68 - 12.88					
L 406 DG (309.100, 309.101, 309.102, 309.103)	01.68-12.74	OM615, 616, 621		3082 121 031	228 M228	->Chass. 145736 LHD ->Chass. 148036 RHD Nur verbauen, wenn Fahrzeug mit M-Kupplung ausgerüstet ist / Only install if the vehicle is equipped with an M-type clutch	(50)
				3151 034 031 ▲	KZI-1	->Chass. 145736 LHD ->Chass. 148036 RHD 309.100-103/111-116/124-126 Nur verbauen, wenn Fahrzeug mit M-Kupplung ausgerüstet ist / Only install if the vehicle is equipped with an M-type clutch	(50)
				3082 121 031	228 M228	Chass. 145737 LHD - Chass. 182065 LHD Chass. 148037 RHD - Chass. 182065 RHD 309.100-103/111-116/124-126	
				1861 557 236 #	228 10 228GSB	Chass. 145737 LHD - Chass. 182065 LHD Chass. 148037 RHD - Chass. 182065 RHD 309.102-103	
				1878 634 052	228 10 228GSB	Chass. 145737 LHD - Chass. 182065 LHD Chass. 148037 RHD - Chass. 182065 RHD 309.102-103	
				3151 034 031 ▲	KZI-1	Chass. 145737 LHD - Chass. 182065 LHD Chass. 148037 RHD - Chass. 182065 RHD 309.100-103/111-116/124-126	
				3082 121 031	228 M228	Chass. 182066 - Chass. 556499 309.100-103/111-116/124-126	
				1878 634 052	228 10 228GSB	Chass. 182066 - Chass. 556499 309.102-103	
				1861 557 236 #	228 10 228GSB	Chass. 182066 - Chass. 556499 309.102-103	
				3151 000 206	KZIS-1	Chass. 182066 - Chass. 556499 309.100-103/111-116/124-126	
				3082 121 031	228 M228	Chass. 556500-> 309.100-103/111-116/124-126	
				3151 000 206	KZIS-1	Chass. 556500-> 309.100-103/111-116/124-126	









































		CODE				
--	--	------	--	---	---	---

MERCEDES-BENZ

T2/L Pritsche / Flatbed		01.68 - 12.88					
L 407 D (309.100, 309.101, 309.102, 309.103), 48 kW L 407 D (309.100, 309.101, 309.102, 309.103), 53 kW	01.75 - 12.88	OM615, 616, 621	 3082 121 031	228 M228	->Chass. 145736 LHD ->Chass. 148036 RHD 309.100-103/111-116/124-126 Nur verbauen, wenn Fahrzeug mit M-Kupplung ausgerüstet ist / Only install if the vehicle is equipped with an M-type clutch	(50)	
	01.75 - 12.88		 3151 034 031 ▲	KZI-1	->Chass. 145736 LHD ->Chass. 148036 RHD 309.100-103/111-116/124-126 Nur verbauen, wenn Fahrzeug mit M-Kupplung ausgerüstet ist / Only install if the vehicle is equipped with an M-type clutch	(50)	
			 3082 121 031	228 M228	Chass. 145737 LHD - Chass. 182065 LHD Chass. 148037 RHD - Chass. 182065 RHD 309.100-103/111-116/124-126		
			 1861 557 236 #	228 10 228GSB	Chass. 145737 LHD - Chass. 182065 LHD Chass. 148037 RHD - Chass. 182065 RHD 309.102-103		
			1878 634 052	228 10 228GSB	Chass. 145737 LHD - Chass. 182065 LHD Chass. 148037 RHD - Chass. 182065 RHD 309.102-103		
			 3151 034 031 ▲	KZI-1	Chass. 145737 LHD - Chass. 182065 LHD Chass. 148037 RHD - Chass. 182065 RHD 309.100-103/111-116/124-126		
			 3082 121 031	228 M228	Chass. 182066 - Chass. 556499 309.100-103/111-116/124-126		
			 1861 557 236 #	228 10 228GSB	Chass. 182066 - Chass. 556499 309.102-103		
			1878 634 052	228 10 228GSB	Chass. 182066 - Chass. 556499 309.102-103		
			 3151 000 206	KZIS-1	Chass. 182066 - Chass. 556499 309.100-103/111-116/124-126		
			 3082 121 031	228 M228	Chass. 556500-> 309.100-103/111-116/124-126		
			 3151 000 206	KZIS-1	Chass. 556500-> 309.100-103/111-116/124-126		
			OM615, 616	 3082 121 031	228 M228		
				 1861 557 236 #	228 10 228GSB		
				1878 634 052	228 10 228GSB		
		 3151 034 031 ▲	KZI-1				
L 408 DG (309.300, 309.301, 309.302, 309.303)	01.70 - 12.74	OM314	 1882 205 234	250 HBX250			
			 1861 291 136	250 10 250GTZ			
			 3151 095 043	KZI-3	->Chass. 145736 LHD ->Chass. 148036 RHD		
			 3151 033 031	KZI-3	Chass. 145737 LHD - Mot. 678174 LHD Chass. 148037 RHD - Mot. 678174 RHD		
			 1800 125 201	250 10 HBX250 250GTZ KZI-3	Mot. 678175->		
			 1882 205 234	250 10 HBX250 250GTZ KZI-3			
			 1861 291 136	250 10 250GTZ			
			 3151 095 043	KZI-3			
L 508 DG (309.400, 309.401, 309.402, 309.403, 309.404...), 60 kW L 508 DG (309.400, 309.401, 309.402, 309.403, 309.404...), 63 kW	01.70 - 12.88	OM314	 1800 125 201	250 10 HBX250 250GTZ KZI-3	Mot. 678175->		
			 1882 205 234	250 HBX250	->Chass. 145736 LHD ->Chass. 148036 RHD		
	01.70 - 12.88		 1861 291 136	250 10 250GTZ	->Chass. 145736 LHD ->Chass. 148036 RHD		
			 3151 095 043	KZI-3	->Chass. 145736 LHD ->Chass. 148036 RHD		



























		CODE				
--	--	------	--	---	---	---

MERCEDES-BENZ

T2/L Pritsche / Flatbed 01.68 - 12.88							
L 608 D (310.300, 310.301, 310.302, 310.303, 310.304...)	01.70 - 12.88	OM314.948, OM314.967	 1800 125 201	250 10	Mot. 410748-> 310.300-305/311-316/324-329/340-345/400-405 /411-416/424-429/440-445		
			 1882 205 234	HBX250			
			 1861 291 136	250GTZ			
			 3151 095 043	KZI-3	->Chass. 145736 LHD		
			 3151 033 031	KZI-3	->Chass. 148036 RHD /411-416/424-429/440-445 310.300-305/311-316/324-329/340-345/400-405		
L 613 D (313.402, 313.404)	04.77 - 12.88	OM353.963, OM353.966	 1882 317 131	280	->Chass. 346882		
			 1861 632 032	HVB280			
			 1861 919 134	280 10			
			 3151 044 031	280W2GSZ			
			 1861 919 134	280 10	Chass. 346883->		
			 3151 044 031	280GTZ			
L 911 (328.001, 328.002, 328.003, 328.005, 328.020...)	01.72 - 07.83	OM352.989, OM352.911, OM352.906	 1861 919 134	280 10	->Chass. 012769		
			 3151 095 043	280GTZ			
			 3151 095 043	KZI-3			
T2/L Sattelschlepper 01.72 - 07.83							
L 911 (328.020, 328.022)	01.72 - 07.83	OM352.911	 1861 919 134	280 10			
			 3151 095 043	280GTZ			
			 1882 201 132 HD	KZI-3			
			 1861 279 133 HD	295			
			 3151 095 043 HD	GF295			
			 1861 279 133 HD	295 10			
			 3151 095 043 HD	295GTZ			
			 1861 279 133 HD	KZI-3			
T2/L Kommunalfahrzeug 06.72 - 08.82							
LF 408 G (309.050, 309.051, 309.052, 309.053, 309.054...), 55 kW	08.72 - 12.74	M115, 121	 1878 634 052	228 10	->Chass. 145736		
			 1861 557 236 #	228 10			
	LF 408 G (309.050, 309.051, 309.052, 309.053, 309.054...), 63 kW	08.72 - 12.74		 3082 121 031	228	->Chass. 145736	
				 3151 034 031 ▲	M228		
	LF 409 G (309.050, 309.051, 309.052, 309.053, 309.054...)	01.75 - 08.82		 3082 121 031	228	->Chass. 145736	(50)
				 1861 557 236 #	M228		
				 1878 634 052	228 10	->Chass. 145736	
				 3151 034 031 ▲	228GSB	Nur verbauen, wenn Fahrzeug mit M-Kupplung ausgerüstet ist / Only install if the vehicle is equipped with an M-type clutch	(50)
				 3151 000 206	KZI-1	->Chass. 145736	
				 1863 869 010	KZIS-1	Nur verbauen, wenn Fahrzeug mit M-Kupplung ausgerüstet ist / Only install if the vehicle is equipped with an M-type clutch	(50)
				 1861 557 236 #	35	Chass. 184087->	
				 1878 634 052	Nadellager / Needle Bearing		(47)
	LKO 508 DG (309.430, 309.431, 309.432, 309.433, 309.435)	06.72 - 02.77	OM314	 1882 205 234	250	->Chass. 145736 LHD	
 1861 291 136				250 10			
 3151 095 043				HBX250			
 3151 033 031				250GTZ			
			 3151 095 043	KZI-3	->Chass. 148036 RHD		
			 3151 033 031	KZI-3	Chass. 145737 LHD->		
					Chass. 148036 RHD->		
					309.430-433/435		















		CODE				
--	--	------	--	---	---	---









MERCEDES-BENZ

T2/LN1 Kasten / Box		04.86 - 12.94						
510 (667.061, 667.062), 70 kW 510 (667.061, 667.062), 77 kW	04.86 - 12.94	OM102		3082 121 031	228	667.001-002/061-062		
	04.86 - 12.94			3151 000 206	M228 KZIS-1	667.001-002/061-062		
507 D (667.361, 667.362)	04.86 - 04.89	OM616		3082 121 031	228	667.301-302/341-342/361-362		
				3151 000 206	M228 KZIS-1	667.301-302/341-342/361-362		
				3000 297 002 ⊗ 3082 121 031 ⊗ 1861 936 142 ⊙ 3151 000 206	228 10 M228 228VTB KZIS-1	Chass. 962133-> 667.301-302/341-342/361-362		
508 D (667.361, 667.362)	03.89 - 12.94	OM601		3082 121 031	228	667.301-302/341-342/361-362		
				1861 936 142	228 10 228VTB	Chass. 962133-> 667.301-302/341-342/361-362		
				3151 000 206	KZIS-1	667.301-302/341-342/361-362		
				1863 869 010	35	667.301-302/341-342/361-362 Nadellager / Needle Bearing	(47)	
609 D (668.061, 668.062, 668.063), 63 kW 609 D (668.061, 668.062, 668.063), 66 kW	04.86 - 12.94	OM364		3400 125 201 ⊗ 3482 054 131 ⊗ 1861 919 134 ⊙ 3151 170 131	280 10 MFZ280 280GTZ KZIZ-3			
	04.86 - 12.94			3400 127 301 # ⊗ 3482 054 131 ⊗ 1878 074 641 ⊙ 3151 170 131	280 10 MFZ280 280GTZ KZIZ-3	für / for: SA33611-01	(68)	
609 D (668.061, 668.062, 668.063), 77 kW	06.94 - 12.94	OM354.902		3400 127 301 # ⊗ 3482 054 131 ⊗ 1878 074 641 ⊙ 3151 170 131	280 10 MFZ280 280GTZ KZIZ-3			
709 D (669.061, 669.062, 669.063), 63 kW 709 D (669.061, 669.062, 669.063), 63 kW 709 D (669.061, 669.062, 669.063), 66 kW 709 D (669.061, 669.062, 669.063), 66 kW 809 D (670.061, 670.062, 670.063), 63 kW 809 D (670.061, 670.062, 670.063), 66 kW	04.86 - 12.94	OM364		3400 125 201 ⊗ 3482 054 131 ⊗ 1861 919 134 ⊙ 3151 170 131	280 10 MFZ280 280GTZ KZIZ-3			
	04.86 - 12.94			3400 127 301 # ⊗ 3482 054 131 ⊗ 1878 074 641 ⊙ 3151 170 131	280 10 MFZ280 280GTZ KZIZ-3	für / for: SA33611-01 Sonderausführung / Special design	(68) (56)	
	04.86 - 12.94							
	04.86 - 12.94							
	04.86 - 12.94							
711 D (669.361, 669.362, 669.363), 77 kW 711 D (669.361, 669.362, 669.363), 85 kW 714 D (669.361, 669.362, 669.363)	04.86 - 12.94	OM364A		3400 124 501 ⊗ 3482 055 132 ⊗ 1861 303 248 ⊙ 3151 170 131	310 10 MFZ310 310GSB KZIZ-3			
	04.86 - 12.94			1862 299 032	310 10 310WGSZ	Sonderausführung / Special design Kupplungsscheibe mit Vordämpfer / clutch disc with predamper	(56) (37)	
	06.94 - 12.94							
811 D (670.362, 670.363), 77 kW 811 D (670.362, 670.363), 85 kW	04.86 - 12.94	OM364A		3400 124 501 ⊗ 3482 055 132 ⊗ 1861 303 248 ⊙ 3151 170 131	310 10 MFZ310 310GSB KZIZ-3	670.302-303/341-342/362-363		
	04.86 - 12.94							
814 D (670.364, 670.365, 670.366), 100 kW 814 D (670.364, 670.365, 670.366), 103 kW	11.87 - 12.94	OM364LA		3482 055 132	310 MFZ310			
	11.87 - 12.94			1861 303 248	310 10 310GSB			
				3151 170 131	KZIZ-3			
				1863 869 010	35	Nadellager / Needle Bearing	(47)	
814 DA 4x4 (670.464, 670.465), 100 kW 814 DA 4x4 (670.464, 670.465), 103 kW	11.87 - 12.94	OM364LA		3482 055 132	310 MFZ310			
	11.87 - 12.94			1861 303 248	310 10 310GSB			
				1862 299 032	310 10 310WGSZ	Kupplungsscheibe mit Vordämpfer / clutch disc with predamper	(37)	
				3151 170 131	KZIZ-3			
				1863 869 010	35	Nadellager / Needle Bearing	(47)	

		CODE		 Parameter		
--	--	------	--	---	---	---







MERCEDES-BENZ



T2/LN1 Kipper / Dumptruck 04.86 - 12.94						
507 DK (667.341, 667.342)	04.86-04.89	OM616	 3082 121 031	228 M228	667.301-302/341-342/361-362	
			 3151 000 206	KZIS-1	667.301-302/341-342/361-362	
			 3000 297 002 ⊗ 3082 121 031 ⊗ 1861 936 142 ⊙ 3151 000 206	228 10 M228 228VTB KZIS-1	Chass. 962133-> 667.301-302/341-342/361-362	
508 D (667.301, 667.302, 667.341, 667.342)	03.89-12.94	OM601	 3082 121 031	228 M228	667.301-302/341-342/361-362	
			 1861 936 142	228 10 228VTB	Chass. 962133-> 667.301-302/341-342/361-362	
			 3151 000 206	KZIS-1	667.301-302/341-342/361-362	
			 1863 869 010	35	667.301-302/341-342/361-362 Nadellager / Needle Bearing	(47)
609 DK (668.041, 668.042), 63 kW	04.86-12.94	OM364	 3400 125 201 ⊗ 3482 054 131 ⊗ 1861 919 134 ⊙ 3151 170 131	280 10 MFZ280 280GTZ KZIZ-3		
			 3400 127 301 # ⊗ 3482 054 131 ⊗ 1878 074 641 ⊙ 3151 170 131	280 10 MFZ280 280GTZ KZIZ-3	für / for: SA33611-01	(68)
709 DK (669.041, 669.042), 63 kW	04.86-12.94	OM364	 3400 125 201 ⊗ 3482 054 131 ⊗ 1861 919 134 ⊙ 3151 170 131	280 10 MFZ280 280GTZ KZIZ-3		
			 3400 127 301 # ⊗ 3482 054 131 ⊗ 1878 074 641 ⊙ 3151 170 131	280 10 MFZ280 280GTZ KZIZ-3	für / for: SA33611-01 Sonderausführung / Special design	(68) (56)
			 3400 125 201 ⊗ 3482 054 131 ⊗ 1861 919 134 ⊙ 3151 170 131	280 10 MFZ280 280GTZ KZIZ-3		
			 3400 127 301 # ⊗ 3482 054 131 ⊗ 1878 074 641 ⊙ 3151 170 131	280 10 MFZ280 280GTZ KZIZ-3		
811 DK (670.341, 670.342), 77 kW	04.86-12.94	OM364A	 3400 124 501 ⊗ 3482 055 132 ⊗ 1861 303 248 ⊙ 3151 170 131	310 10 MFZ310 310GSB KZIZ-3	670.302-303/341-342/362-363	
			 3400 124 501 ⊗ 3482 055 132 ⊗ 1861 303 248 ⊙ 3151 170 131	310 10 MFZ310 310GSB KZIZ-3		













T2/LN1 Pritsche / Flatbed 04.86 - 12.94						
510 (667.001, 667.002), 70 kW	04.86-12.94	OM102	 3082 121 031	228 M228	667.001-002/061-062	
			 3151 000 206	KZIS-1	667.001-002/061-062	
507 D (667.301, 667.302, 667.341, 667.342)	04.86-04.89	OM616	 3082 121 031	228 M228	667.301-302/341-342/361-362	
			 3151 000 206	KZIS-1	667.301-302/341-342/361-362	
			 3000 297 002 ⊗ 3082 121 031 ⊗ 1861 936 142 ⊙ 3151 000 206	228 10 M228 228VTB KZIS-1	Chass. 962133-> 667.301-302/341-342/361-362	
609 D (668.001, 668.002, 668.003), 63 kW	04.86-12.94	OM364	 3400 125 201 ⊗ 3482 054 131 ⊗ 1861 919 134 ⊙ 3151 170 131	280 10 MFZ280 280GTZ KZIZ-3		
			 3400 127 301 # ⊗ 3482 054 131 ⊗ 1878 074 641 ⊙ 3151 170 131	280 10 MFZ280 280GTZ KZIZ-3	für / for: SA33611-01	(68)
609 D (668.001, 668.002, 668.003), 77 kW	06.94-12.94	OM354.902	 3400 127 301 # ⊗ 3482 054 131 ⊗ 1878 074 641 ⊙ 3151 170 131	280 10 MFZ280 280GTZ KZIZ-3		

		CODE				
--	--	------	--	---	---	---

MERCEDES-BENZ



T2/LN1 Pritsche / Flatbed 04.86 - 12.94						
709 D (669.000, 669.001, 669.002, 669.003, 669.041), 63 kW	04.86 - 12.94	OM364		3400 125 201 ⊗ 3482 054 131 ⊗ 1861 919 134 ⊙ 3151 170 131	280 10 MFZ280 280GTZ KZIZ-3	
709 D (669.000, 669.001, 669.002, 669.003, 669.041), 63 kW	04.86 - 12.94			3400 127 301 # ⊗ 3482 054 131 ⊗ 1878 074 641 ⊙ 3151 170 131	280 10 MFZ280 280GTZ KZIZ-3	für / for: SA33611-01 Sonderausführung / Special design (68) (56)
709 D (669.000, 669.001, 669.002, 669.003, 669.041), 66 kW	04.86 - 12.94			1863 869 010	35	Nadellager / Needle Bearing (47)
709 D (669.000, 669.001, 669.002, 669.003, 669.041), 66 kW	04.86 - 12.94					
809 D (670.001, 670.002, 670.003), 63 kW	04.86 - 12.94					
809 D (670.001, 670.002, 670.003), 66 kW	04.86 - 12.94					
711 D (669.301, 669.302, 669.303), 77 kW	04.86 - 12.94	OM364A		3400 124 501 ⊗ 3482 055 132 ⊗ 1861 303 248 ⊙ 3151 170 131	310 10 MFZ310 310GSB KZIZ-3	
711 D (669.301, 669.302, 669.303), 85 kW	04.86 - 12.94			1862 299 032	310 10 310WGSZ	Sonderausführung / Special design Kupplungsscheibe mit Vordämpfer / clutch disc with predamper (56) (37)
714 D (669.301, 669.302, 669.303)	06.94 - 12.94			1863 869 010	35	Nadellager / Needle Bearing (47)
814 D (670.312, 670.313), 100 kW	11.87 - 12.94					
814 DA 4x4 (670.411, 670.412), 100 kW	11.87 - 12.94					
814 D (670.312, 670.313), 103 kW	11.87 - 12.94					
814 DA 4x4 (670.411, 670.412), 103 kW	11.87 - 12.94					
811 D (670.302, 670.303), 77 kW	04.86 - 12.94	OM364A		3400 124 501 ⊗ 3482 055 132 ⊗ 1861 303 248 ⊙ 3151 170 131	310 10 MFZ310 310GSB KZIZ-3	670.302-303/341-342/362-363
811 D (670.302, 670.303), 85 kW	04.86 - 12.94					





















T2/LN1 Triebkopf 04.86 - 12.94						
809 DT (670.199), 63 kW	04.86 - 12.94	OM364		3400 125 201 ⊗ 3482 054 131 ⊗ 1861 919 134 ⊙ 3151 170 131	280 10 MFZ280 280GTZ KZIZ-3	
809 DT (670.199), 66 kW	04.86 - 12.94			3400 127 301 # ⊗ 3482 054 131 ⊗ 1878 074 641 ⊙ 3151 170 131	280 10 MFZ280 280GTZ KZIZ-3	für / for: SA33611-01 Sonderausführung / Special design (68) (56)

MB / MBO						
MB 500 (684.040)		M384.906		3482 046 031 #	280 MF280	
				1861 919 134	280 10 280GTZ	
				3151 000 020	KZI-3	
MB 700 (684.043) MBO 700 (684.047/48) MBO 800 / 38 (684.448)		M384.907		3482 008 038	310 MF310	
				1861 303 248	310 10 310GSB	
				3151 000 020	KZI-3	
MB 800 T (397.243)		M384.900		3482 008 038	310 MF310	
				1878 026 431	310 10 310WTB	
				3151 000 020	KZI-3	
MB 800 T/35 (371.043)		M380.940, M380.942, M380.943		3482 008 038	310 MF310	
				1878 026 431	310 10 310WTB	
				3151 000 020	KZI-3	Chass. KAL 34/98->

		CODE				
--	--	------	--	---	---	---

MERCEDES-BENZ









MB / MBO						
MB 800 / 32 (684.093)		M384.907,		3482 008 038	310	
MB 800 / 32ATL (684.083)		M384.908			MF310	
MB 800 / 38 (684.088)				1878 026 431	310 10	
MB 800 / 38 (684.091/098/444)					310WTB	
MBO 800 / 38 (684.449)				3151 000 020	KZI-3	
MB 800 / 38ATL (684.081)						

VIANO (W639) 09.03 -						
CDI 2.0, 80 kW	09.03 -	OM646DE22LA		3000 951 111 	230 26	XTend ->Chass. 152223 ->05.2005 Getr. / GBox: 716.637 (SG-S250) 639.811/813/815 Nabenprofil / Hub Profile: 26,56x28,9-26N (46)
				3000 951 112 	240 26	XTend ->Chass. 152223 ->05.2005 Getr. / GBox: 716.652 (SG-S370) 639.811/813/815 Nabenprofil / Hub Profile: 26,6x28,9-26N (46)
				3000 951 112 	240 26	XTend Chass. 152224-> 05.2005-> 639.811/813/815 Nabenprofil / Hub Profile: 26,6x28,9-26N (46)
				2294 000 834	240	639.811/813/815 enthält Schwungradbefestigungsschrauben / includes bolt for flyweel mounting (65)
				3182 997 804 	HHAS-1	Getr. / GBox: 716.652 (SG-S370) Getr. / GBox: 716.680 (TSG-360) 639.811/813/815 Immer erneuern / Renew everytime (28)
				3182 997 803	HHAS-1	Getr. Nr. / GBox No.: ->011 088 ->10.2003 Getr. / GBox: 716.637 (SG-S250) 639.811/813/815 Immer erneuern / Renew everytime (28)
				3182 997 804 	HHAS-1	Getr. Nr. / GBox No.: 011 089-> 10.2003-> Getr. / GBox: 716.637 (SG-S250) 639.811/813/815 Immer erneuern / Renew everytime (28)
	OM646.982		6284 605 008			
CDI 2.0 4-matic CDI 2.0, 85 kW CDI 2.2, 110 kW	07.05 - 08.05 - 09.03 -	OM646DE22LA		3000 951 112 	240 26	XTend 639.811/813/815 Nabenprofil / Hub Profile: 26,6x28,9-26N (46)
				2294 000 834	240	639.811/813/815 enthält Schwungradbefestigungsschrauben / includes bolt for flyweel mounting (65)
				3182 997 804 	HHAS-1	639.811/813/815 Immer erneuern / Renew everytime (28)
	OM646.982		6284 605 008			
CDI 2.0, 100 kW CDI 2.2, 120 kW	07.10 - 07.10 -	OM651.940		3000 990 287 	240	XTend Kit plus CSC
				6284 605 008		
		OM651DE22LA		2294 000 994	240 240	639.811/813/815 enthält Schwungradbefestigungsschrauben / includes bolt for flyweel mounting (65)



























		CODE				
--	--	------	--	---	---	---

MERCEDES-BENZ

VIANO (W639) 09.03 -

CDI 2.2 4-matic	07.05-	OM646DE22LA		3000 951 112 	240 26	XTend 639.811/813/815 Nabenprofil / Hub Profile: 26,6x28,9-26N (46)
				2294 000 834	240	639.811/813/815 enthält Schwungradbefestigungsschrauben / includes bolt for flywheel mounting (65)
				3182 997 804 	HHAS-1	Getr. / GBox: 716.652 (SG-S370) Getr. / GBox: 716.680 (TSG-360) 639.811/813/815 Immer erneuern / Renew everytime (28)
				3182 997 803	HHAS-1	Getr. Nr. / GBox No.: ->011 088 ->10.2003 Getr. / GBox: 716.637 (SG-S250) 639.811/813/815 Immer erneuern / Renew everytime (28)
				3182 997 804 	HHAS-1	Getr. Nr. / GBox No.: 011 089->10.2003-> Getr. / GBox: 716.637 (SG-S250) 639.811/813/815 Immer erneuern / Renew everytime (28)
		OM646.982		6284 605 008		















VITO Kasten / Box (638) 03.97 - 07.03

113 2.0 (638.014, 638.094)	03.97-07.03	M111.948		3000 726 001  3082 267 233  1864 503 231  3151 248 031	228 26 M228X 228B KZIS-0	638.014		
				1863 869 010	35	->Mot. 003396 638.014 Nadellager / Needle Bearing (47)		
				6283 600 539		638.014		
		M111.950		3000 951 784 	240 26	XTend 638.094 Nabenprofil / Hub Profile: 26,5x28,7-26N Starre Kupplungsscheibe / rigid clutch disc (46) (57)		
				3182 997 801	HHAS-1	638.094 Immer erneuern / Renew everytime (28)		
		M111.948, M111.950		1863 869 012	28	638.014/094 für Motoren mit Zweimassenschwungrad / for engines with dual-mass flywheel Nadellager / Needle Bearing (80) (47)		
				6284 600 573		638.014/094		
		114 2.3 (638.034, 638.094)	03.97-07.03	M111.978		3000 846 501  3082 268 031  1864 464 031  3151 248 031	240 26 M240 240D KZIS-0	638.034
						1863 869 010	35	->Mot. 002723 638.034 Nadellager / Needle Bearing (47)
						6283 600 539		638.034
M111.980				3000 951 784 	240 26	XTend 638.094 Nabenprofil / Hub Profile: 26,5x28,7-26N Starre Kupplungsscheibe / rigid clutch disc (46) (57)		
				3182 997 801	HHAS-1	638.094 Immer erneuern / Renew everytime (28)		
M111.978, M111.980				1863 869 012	28	638.034/094 für Motoren mit Zweimassenschwungrad / for engines with dual-mass flywheel Nadellager / Needle Bearing (80) (47)		
				6284 600 573		638.034/094		
108 CDI 2.2 (638.094) 110 CDI 2.2 (638.094) 112 CDI 2.2 (638.094)	03.99-07.03 03.99-07.03 03.99-07.03			OM611A (60KWCDI), OM611.980, OM611LA(75 KWCDI)		3000 951 784 	240 26	XTend Nabenprofil / Hub Profile: 26,5x28,7-26N Starre Kupplungsscheibe / rigid clutch disc (46) (57)
						2294 001 744	240	enthält Schwungradbefestigungsschrauben / includes bolt for flywheel mounting (65)
						3182 997 801	HHAS-1	Immer erneuern / Renew everytime (28)
			6284 600 573					

















		CODE				
--	--	------	--	---	---	---

MERCEDES-BENZ

VITO Kasten / Box (638) 03.97 - 07.03































108 D 2.3 (638.064)	03.97-07.03	OM601.942	 3000 951 205  3082 267 233  1878 005 187  3151 248 031	228 26 M228X 228VTB KZIS-0	Torsionsgefederte Kupplungsscheibe / torsion damper clutch disc	(58)
			 1863 869 010	35	Nadellager / Needle Bearing	(47)
			 6283 600 539			
			 6284 600 573			
110 D 2.3 (638.074)	03.97-07.03	OM601.970	 3000 846 501  3082 268 031  1864 464 031  3151 248 031	240 26 M240 240D KZIS-0		
			 1863 869 010	35	Nadellager / Needle Bearing	(47)
			 6283 600 539			
			 6284 600 573			

VITO Kasten / Box (639) 09.03 -

109 CDI	09.03-	OM646DE22LA	 3000 951 111 	230 26	XTend 639.601/603/605 Nabenprofil / Hub Profile: 26,56x28,9-26N	(46)
			 2294 000 834	240	639.601/603/605 enthält Schwungradbefestigungsschrauben / includes bolt for flywheel mounting	(65)
			 3182 997 804 	HHAS-1	Getr. / GBox: 716.652 (SG-S370) Getr. / GBox: 716.680 (TSG-360) 639.601/603/605 Immer erneuern / Renew everytime	(28)
			3182 997 803	HHAS-1	Getr. Nr. / GBox No.: ->011 088 ->10.2003 Getr. / GBox: 716.637 (SG-S250) 639.601/603/605 Immer erneuern / Renew everytime	(28)
			OM646.983	 6284 605 008		
109 CDi	08.06-	OM646DE22LA	 3000 951 111 	230 26	XTend 639.601/603/605 Nabenprofil / Hub Profile: 26,56x28,9-26N	(46)
			 2294 000 834	240	639.601/603/605 enthält Schwungradbefestigungsschrauben / includes bolt for flywheel mounting	(65)
			 3182 997 804 	HHAS-1	639.601/603/605 Immer erneuern / Renew everytime	(28)
		OM646.981	 6284 605 008			
110 CDI	09.10-	OM651.940	 3000 990 287 	240	XTend Kit plus CSC	
			 2294 000 994	240 240	enthält Schwungradbefestigungsschrauben / includes bolt for flywheel mounting	(65)
			 6284 605 008			















		CODE				
--	--	------	--	---	---	---

MERCEDES-BENZ





VITO Kasten / Box (639) 09.03 -						
111 CDI, 80 kW	09.03-	OM646DE22LA		3000 951 111 	230 26	XTend ->Chass. 152223 ->05.2005 Getr. / GBox: 716.637 (SG-S250) 639.601/603/605 Nabenprofil / Hub Profile: 26,56x28,9-26N (46)
				3000 951 112 	240 26	XTend ->Chass. 152223 ->05.2005 Getr. / GBox: 716.652 (SG-S370) 639.601/603/605 Nabenprofil / Hub Profile: 26,6x28,9-26N (46)
				3000 951 112 	240 26	XTend Chass. 152224-> 05.2005-> 639.601/603/605 Nabenprofil / Hub Profile: 26,6x28,9-26N (46)
				2294 000 834	240	639.601/603/605 enthält Schwungradbefestigungsschrauben / includes bolt for flywheel mounting (65)
				3182 997 804 	HHAS-1	Getr. / GBox: 716.652 (SG-S370) Getr. / GBox: 716.680 (TSG-360) 639.601/603/605 Immer erneuern / Renew everytime (28)
				3182 997 803	HHAS-1	Getr. Nr. / GBox No.: ->011 088 ->10.2003 Getr. / GBox: 716.637 (SG-S250) 639.601/603/605 Immer erneuern / Renew everytime (28)
				3182 997 804 	HHAS-1	Getr. Nr. / GBox No.: 011 089-> 10.2003-> Getr. / GBox: 716.637 (SG-S250) 639.601/603/605 Immer erneuern / Renew everytime (28)
	OM646.982		6284 605 008			
111 CDI 4x4 115 CDI 115 CDI 4x4	09.07 - 09.03 - 07.06 -	OM646DE22LA		3000 951 112 	240 26	XTend 639.601/603/605 Nabenprofil / Hub Profile: 26,6x28,9-26N (46)
				2294 000 834	240	639.601/603/605 enthält Schwungradbefestigungsschrauben / includes bolt for flywheel mounting (65)
				3182 997 804 	HHAS-1	Getr. / GBox: 716.680 (TSG-360) Getr. / GBox: 716.652 (SG-S370) 639.601/603/605 Immer erneuern / Renew everytime (28)
				3182 997 803	HHAS-1	Getr. Nr. / GBox No.: ->011 088 ->10.2003 Getr. / GBox: 716.637 (SG-S250) 639.601/603/605 Immer erneuern / Renew everytime (28)
				3182 997 804 	HHAS-1	Getr. Nr. / GBox No.: 011 089-> 10.2003-> Getr. / GBox: 716.637 (SG-S250) 639.601/603/605 Immer erneuern / Renew everytime (28)
	OM646.982		6284 605 008			
111 CDI, 85 kW	09.07 -	OM646DE22LA		3000 951 112 	240 26	XTend 639.601/603/605 Nabenprofil / Hub Profile: 26,6x28,9-26N (46)
				2294 000 834	240	639.601/603/605 enthält Schwungradbefestigungsschrauben / includes bolt for flywheel mounting (65)
				3182 997 804 	HHAS-1	639.601/603/605 Immer erneuern / Renew everytime (28)
			OM646.982		6284 605 008	
113 CDI	09.10 -	OM651.940		3000 990 287 	240	XTend Kit plus CSC
				6284 605 008		
		OM651DE22LA		2294 000 994	240 240	639.601/603/605 enthält Schwungradbefestigungsschrauben / includes bolt for flywheel mounting (65)
116 CDI	09.10 -	OM651.940		3000 990 287 	240	XTend Kit plus CSC
					6284 605 008	

		CODE				
--	--	------	--	---	---	---

MERCEDES-BENZ





ANTOS		07.12 -		
ANTOS 1852 - 4163 OM473 min:2600NM Euro 6	01.13-	OM473	 3400 700 534   430 18 XTend für / for: max. 520 PS (68) Nabenprofil / Hub Profile: 45x50-18N (46) Abgasnorm: Euro 6 / Exhaust Emission Norm: Euro 6 (4) max. übertragbares Motormoment [Nm] / max. (87) transmittable engine torque [Nm]: 2600 Nur zusammen verbauen / Only install together (51)	
			 3400 700 609   3488 000 366 MFZ2/400X  1878 007 185 400WGTZ  3151 001 083 KZISZ-5	400 18 Abgasnorm: Euro 6 / Exhaust Emission Norm: Euro 6 (4)
			 3400 700 529   430 18 XTend für / for: max. 520 PS (68) Getr. / GBox: Powershift Nabenprofil / Hub Profile: 45x50-18N (46) Abgasnorm: Euro 6 / Exhaust Emission Norm: Euro 6 (4) max. übertragbares Motormoment [Nm] / max. (87) transmittable engine torque [Nm]: 2600 Nur zusammen verbauen / Only install together (51)	
			 3400 700 535  400 MF2/400E	XTend Getr. / GBox: Powershift Abgasnorm: Euro 6 / Exhaust Emission Norm: Euro 6 (4) Nur zusammen verbauen / Only install together (51)
			 6482 000 218 PHIS-6/38	Getr. / GBox: Powershift Abgasnorm: Euro 6 / Exhaust Emission Norm: Euro 6 (4) Immer erneuern / Renew everytime (28)

MERCEDES-BENZ





ANTOS		07.12 -					
1833 L 963.005 963.003/004	07.12-	OM470		3400 700 532 	430 18	XTend Nabenprofil / Hub Profile: 45x50-18N Abgasnorm: Euro 6 / Exhaust Emission Norm: Euro 6	(46) (4)
1833 LS 963.406 963.405 963.403/404	07.12-					max. übertragbares Motormoment [Nm] / max. transmittable engine torque [Nm]: 1900	(87)
1836 L 963.005 963.003/004	07.12-					Nur zusammen verbauen / Only install together	(51)
1836 LS 963.403 963.406 963.404/405	07.12-			3400 700 530 	430 18	XTend Getr. / GBox: Powershift Nabenprofil / Hub Profile: 45x50-18N Abgasnorm: Euro 6 / Exhaust Emission Norm: Euro 6	(46) (4)
1840 L 963.003 963.005 963.004	07.12-					max. übertragbares Motormoment [Nm] / max. transmittable engine torque [Nm]: 1900	(87)
1840 LS 963.403-406	07.12-					Nur zusammen verbauen / Only install together	(51)
1843 L 963.003 963.005 963.004	07.12-			6482 000 218	PHIS-6/38	Getr. / GBox: Powershift Abgasnorm: Euro 6 / Exhaust Emission Norm: Euro 6	(4) (28)
1843 LS 963.404 963.406 963.403 963.405	07.12-					Immer erneuern / Renew everytime	
2033 L 963.002	07.12-						
2033 LS 963.402	07.12-						
2036 L 963.002	07.12-						
2036 LS 963.402	07.12-						
2040 L 963.002	07.12-						
2040 LS 963.402	07.12-						
2043 L 963.002	07.12-						
2043 LS 963.402	07.12-						
2433 LS 963.427	07.12-						
2436 LS 963.427	07.12-						
2440 LS 963.427	07.12-						
2443 LS 963.427	07.12-						
2533 L 963.020/021	07.12-						
2533 LS 963.420 963.423	07.12-						
2533 LS 963.423	07.12-						
2536 L 963.020/021	07.12-						
2536 LS 963.420 963.423	07.12-						
2540 L 963.020/021	07.12-						
2540 LS 963.423 963.420	07.12-						
2543 L 963.020/021	07.12-						
2543 LS 963.423 963.420	07.12-						
2633 L 963.024/025	07.12-						
2633 L 963.024	07.12-						
2633 LS 963.424	07.12-						

		CODE				
--	--	------	--	---	---	---

MERCEDES-BENZ





ANTOS		07.12 -			
2633 LS 963.424/425	07.12-	OM470	 3400 700 532  430 18 XTend Nabenprofil / Hub Profile: 45x50-18N Abgasnorm: Euro 6 / Exhaust Emission Norm: Euro 6 max. übertragbares Motormoment [Nm] / max. transmittable engine torque [Nm]: 1900 Nur zusammen verbauen / Only install together	(46) (4) (87) (51)	
2636 L 963.025 963.024	07.12-				
2636 L 963.024	07.12-		 3400 700 530  430 18 XTend Getr. / GBox: Powershift Nabenprofil / Hub Profile: 45x50-18N Abgasnorm: Euro 6 / Exhaust Emission Norm: Euro 6 max. übertragbares Motormoment [Nm] / max. transmittable engine torque [Nm]: 1900 Nur zusammen verbauen / Only install together	(46) (4) (87) (51)	
2636 LS 963.424/425	07.12-				
2636 LS 963.424	07.12-				
2640 L 963.025 963.024	07.12-		 6482 000 218 PHIS-6/38	Getr. / GBox: Powershift Abgasnorm: Euro 6 / Exhaust Emission Norm: Euro 6 Immer erneuern / Renew everytime	(4) (28)
2640 L 963.024	07.12-				
2640 LS 963.424/425	07.12-				
2640 LS 963.424	07.12-				
2643 L 963.024/025	07.12-				
2643 L 963.024	07.12-				
2643 LS 963.424/425	07.12-				
2643 LS 963.424	07.12-				
3333 L 963.026	07.12-				
3333 LS 963.426	07.12-				
3336 L 963.026	07.12-				
3336 LS 963.426	07.12-				
3340 L 963.026	07.12-				
3340 LS 963.426	07.12-				
3343 L 963.026	07.12-				
3343 LS 963.426	07.12-				

MERCEDES-BENZ





ANTOS		07.12 -					
1835 LS 963.404-406 963.403	07.12-	OM936		3400 700 533 	430 18	XTend Nabenprofil / Hub Profile: 45x50-18N Abgasnorm: Euro 6 / Exhaust Emission Norm: Euro 6 max. übertragbares Motormoment [Nm] / max. transmittable engine torque [Nm]: 2100 Nur zusammen verbauen / Only install together	(46) (4) (87) (51)
1824 L 963.003 963.005 963.004	07.12-						
2024 L 963.002	07.12-			3400 700 531 	430 18	XTend Getr. / GBox: Powershift Nabenprofil / Hub Profile: 45x50x-18N Abgasnorm: Euro 6 / Exhaust Emission Norm: Euro 6 max. übertragbares Motormoment [Nm] / max. transmittable engine torque [Nm]: 2100 Nur zusammen verbauen / Only install together	(46) (4) (87) (51)
2024 LS 963.402	07.12-						
2027 L 963.002	07.12-						
1824 LS 963.405 963.404 963.403	07.12-			6482 000 218	PHIS-6/38	Getr. / GBox: Powershift Abgasnorm: Euro 6 / Exhaust Emission Norm: Euro 6 Immer erneuern / Renew everytime	(4) (28)
2027 LS 963.402	07.12-						
2030 L 963.002	07.12-						
2030 LS 963.402	07.12-						
2032 L 963.002	07.12-						
2032 LS 963.402	07.12-						
2035 L 963.002	07.12-						
2035 LS 963.402	07.12-						
1827 L 963.005 963.003/004	07.12-						
1827 LS 963.404-406 963.403	07.12-						
2427 LS 963.427	07.12-						
2430 LS 963.427	07.12-						
2432 LS 963.427	07.12-						
1830 L 963.003 963.005 963.004	07.12-						
2527 L 963.021 963.020	07.12-						
2527 LS 963.420 963.423	07.12-						
2530 L 963.021 963.020	07.12-						
2530 LS 963.423 963.420	07.12-						
1830 LS 963.403 963.406 963.404/405	07.12-						
2532 L 963.021 963.020	07.12-						
2532 LS 963.420 963.423	07.12-						
2535 L 963.020/021	07.12-						
1832 L 963.004/005 963.003	07.12-						
2535 LS 963.420 963.423	07.12-						
1832 LS 963.405 963.403 963.406	07.12-						
1835 L 963.004/005 963.003	07.12-						
2627 L 963.024	07.12-						

		CODE				
--	--	------	--	---	---	---

MERCEDES-BENZ





ANTOS		07.12 -			
2627 L 963.024/025	07.12-	OM936	 3400 700 533  430 18 XTend Nabenprofil / Hub Profile: 45x50-18N Abgasnorm: Euro 6 / Exhaust Emission Norm: Euro 6 max. übertragbares Motormoment [Nm] / max. transmittable engine torque [Nm]: 2100 Nur zusammen verbauen / Only install together	(46) (4) (87) (51)	
2627 LS 963.424	07.12-				
2627 LS 963.424/425	07.12-		 3400 700 531  430 18 XTend Getr. / GBox: Powershift Nabenprofil / Hub Profile: 45x50x-18N Abgasnorm: Euro 6 / Exhaust Emission Norm: Euro 6 max. übertragbares Motormoment [Nm] / max. transmittable engine torque [Nm]: 2100 Nur zusammen verbauen / Only install together	(46) (4) (87) (51)	
2630 L 963.024/025	07.12-				
2630 L 963.024	07.12-				
2630 LS 963.425 963.424	07.12-		 6482 000 218 PHIS-6/38	Getr. / GBox: Powershift Abgasnorm: Euro 6 / Exhaust Emission Norm: Euro 6 Immer erneuern / Renew everytime	(4) (28)
2630 LS 963.424	07.12-				
2632 L 963.025 963.024	07.12-				
2632 L 964.024	07.12-				
2632 LS 963.424	07.12-				
2632 LS 963.424/425	07.12-				
2635 L 963.024/025	07.12-				
2635 L 963.024	07.12-				
2635 LS 963.424/425	07.12-				
2635 LS 963.424	07.12-				









MERCEDES-BENZ

ANTOS		07.12 -					
1842 L 963.003-005	07.12-	OM471		3400 700 534 	430 18	XTend Nabenprofil / Hub Profile: 45x50-18N Abgasnorm: Euro 6 / Exhaust Emission Norm: Euro 6 max. übertragbares Motormoment [Nm] / max. transmittable engine torque [Nm]: 2600 Nur zusammen verbauen / Only install together	(46) (4) (87) (51)
1842 LS 963.403 963.405 963.404 963.406	07.12-						
1845 L 963.005 963.003/004	07.12-			3400 700 529 	430 18	XTend Getr. / GBox: Powershift Nabenprofil / Hub Profile: 45x50-18N Abgasnorm: Euro 6 / Exhaust Emission Norm: Euro 6 max. übertragbares Motormoment [Nm] / max. transmittable engine torque [Nm]: 2600 Nur zusammen verbauen / Only install together	(46) (4) (87) (51)
1845 LS 963.404 963.406 963.403 963.405	07.12-						
1848 L 963.003-005	07.12-			6482 000 218	PHIS-6/38	Getr. / GBox: Powershift Abgasnorm: Euro 6 / Exhaust Emission Norm: Euro 6 Immer erneuern / Renew everytime	(4) (28)
1848 LS 963.406 963.405 963.403/404	07.12-						
1851 L 963.004 963.003 963.005	07.12-						
1851 LS 963.403-406	07.12-						
2042 L 963.002	07.12-						
2042 LS 963.402	07.12-						
2045 L 963.002	07.12-						
2045 LS 963.402	07.12-						
2048 L 963.002	07.12-						
2048 LS 963.402	07.12-						
2051 L 963.002	07.12-						
2051 LS 963.402	07.12-						
2442 LS 963.427	07.12-						
2445 LS 963.427	07.12-						
2448 LS 963.427	07.12-						
2451 LS 963.427	07.12-						
2542 L 963.021 963.020	07.12-						
2542 LS 963.420 963.423	07.12-						
2542 LS 963.423	07.12-						
2545 L 963.020/021	07.12-						
2545 LS 963.420 963.423	07.12-						
2548 L 963.020/021	07.12-						
2548 LS 963.423 963.420	07.12-						
2551 L 963.020/021	07.12-						
2551 LS 963.423 963.420	07.12-						
2642 L 963.024/025	07.12-						
2642 L 963.024	07.12-						
2642 LS 963.425 963.424	07.12-						





		CODE				
--	--	------	--	---	---	---

MERCEDES-BENZ

ANTOS		07.12 -				
2642 LS 963.424	07.12-	OM471	 3400 700 534  430 18	XTend Nabenprofil / Hub Profile: 45x50-18N Abgasnorm: Euro 6 / Exhaust Emission Norm: Euro 6 max. übertragbares Motormoment [Nm] / max. transmittable engine torque [Nm]: 2600 Nur zusammen verbauen / Only install together	(46) (4) (87) (51)	
2645 L 963.024	07.12-					
2645 L 963.025 963.024	07.12-		 3400 700 529  430 18	XTend Getr. / GBox: Powershift Nabenprofil / Hub Profile: 45x50-18N Abgasnorm: Euro 6 / Exhaust Emission Norm: Euro 6 max. übertragbares Motormoment [Nm] / max. transmittable engine torque [Nm]: 2600 Nur zusammen verbauen / Only install together	(46) (4) (87) (51)	
2645 LS 963.424	07.12-					
2645 LS 963.424/425	07.12-					
2648 L 963.024	07.12-		 6482 000 218	PHIS-6/38	Getr. / GBox: Powershift Abgasnorm: Euro 6 / Exhaust Emission Norm: Euro 6 Immer erneuern / Renew everytime	(4) (28)
2648 L 963.024/025	07.12-					
2648 LS 963.424	07.12-					
2648 LS 963.424/425	07.12-					
2651 L 963.025 963.024	07.12-					
2651 L 963.024	07.12-					
2651 LS 963.424/425	07.12-					
2651 LS 963.424	07.12-					
3342 L 963.026	07.12-					
3342 LS 963.426	07.12-					
3345 L 963.026	07.12-					
3345 LS 963.426	07.12-					
3348 L 963.026	07.12-					
3348 LS 963.426	07.12-					
3351 L 963.026	07.12-					
3351 LS 963.426	07.12-					

AROCS		01.13 -				
AROCS 1852 - 4163 OM473 min:2600NM Euro 6	01.13-	OM473	 3400 700 534  430 18	XTend für / for: max. 520 PS Nabenprofil / Hub Profile: 45x50-18N Abgasnorm: Euro 6 / Exhaust Emission Norm: Euro 6 max. übertragbares Motormoment [Nm] / max. transmittable engine torque [Nm]: 2600 Nur zusammen verbauen / Only install together	(68) (46) (4) (87) (51)	
			 3400 700 609 	400 18 MFZ2/400X 400WGTZ KZISZ-5	Abgasnorm: Euro 6 / Exhaust Emission Norm: Euro 6 (4)	
			 3400 700 529 	430 18	XTend für / for: max. 520 PS Getr. / GBox: Powershift Nabenprofil / Hub Profile: 45x50-18N Abgasnorm: Euro 6 / Exhaust Emission Norm: Euro 6 max. übertragbares Motormoment [Nm] / max. transmittable engine torque [Nm]: 2600 Nur zusammen verbauen / Only install together	(68) (46) (4) (87) (51)
			 3400 700 535 	400 MF2/400E	XTend Getr. / GBox: Powershift Abgasnorm: Euro 6 / Exhaust Emission Norm: Euro 6 Nur zusammen verbauen / Only install together	(4) (51)
			 6482 000 218	PHIS-6/38	Getr. / GBox: Powershift Abgasnorm: Euro 6 / Exhaust Emission Norm: Euro 6 Immer erneuern / Renew everytime	(4) (28)

MERCEDES-BENZ





AROCS		01.13 -					
1833	01.13-	OM470		3400 700 532 	430 18	XTend Nabenprofil / Hub Profile: 45x50-18N Abgasnorm: Euro 6 / Exhaust Emission Norm: Euro 6 max. übertragbares Motormoment [Nm] / max. transmittable engine torque [Nm]: 1900 Nur zusammen verbauen / Only install together	(46) (4) (87) (51)
964.000	01.13-						
1833 A	01.13-						
964.007	01.13-						
1833 AK	01.13-						
964.207	01.13-			3400 700 530 	430 18	XTend Getr. / GBox: Powershift Nabenprofil / Hub Profile: 45x50-18N Abgasnorm: Euro 6 / Exhaust Emission Norm: Euro 6 max. übertragbares Motormoment [Nm] / max. transmittable engine torque [Nm]: 1900 Nur zusammen verbauen / Only install together	(46) (4) (87) (51)
1833 AS	01.13-						
964.407	01.13-						
1833 K	01.13-						
964.200	01.13-						
1833 LS	01.13-						
964.403	01.13-			6482 000 218	PHIS-6/38	Getr. / GBox: Powershift Abgasnorm: Euro 6 / Exhaust Emission Norm: Euro 6 Immer erneuern / Renew everytime	(4) (28)
2033	01.13-						
964.001	01.13-						
2033 A	01.13-						
964.008	01.13-						
2033 AK	01.13-						
964.208	01.13-						
2033 AS	01.13-						
964.408	01.13-						
2033 K	01.13-						
964.201	01.13-						
2033 S, 2033 LS	01.13-						
964.402 964.401	01.13-						
2533 L	01.13-						
964.020	01.13-						
2533 LS	01.13-						
964.420	01.13-						
2533 LS	01.13-						
964.423	01.13-						
2633 B, 2633 LB	01.13-						
964.324 964.314	01.13-						
2633 K, 2633 LK	01.13-						
964.214 964.224	01.13-						
2633 L	01.13-						
964.025	01.13-						
2633 LS	01.13-						
964.425	01.13-						
2633 S, 2633 LS	01.13-						
964.414 964.424	01.13-						
2633, 2633 L	01.13-						
964.014 964.024	01.13-						
3233 B, 3233 LB	01.13-						
964.330 964.338	01.13-						
3233 K, 3233 LK	01.13-						
964.238 964.230	01.13-						
3233 L	01.13-						
964.041	01.13-						
3233 LB	01.13-						
964.341	01.13-						
3233 LK	01.13-						
964.241	01.13-						
3233, 3233 L	01.13-						
964.030 964.038	01.13-						
3333 A	01.13-						
964.018	01.13-						
3333 AK	01.13-						
964.218	01.13-						
3333 AS	01.13-						
964.418	01.13-						
3333 B, 3333 LB	01.13-						
964.326 964.316	01.13-						
3333 K, 3333 LK	01.13-						
964.216 964.226	01.13-						
3333 S, 3333 LS	01.13-						
964.416 964.426	01.13-						



MERCEDES-BENZ



















AROCS		01.13 -					
3333, 3333 L 964.016 964.026 4133 964.031 4133 AK 964.233 4133 AK 964.232 4133 B 964.331 4133 K 964.231	01.13- 01.13- 01.13- 01.13- 01.13- 01.13- 01.13-	OM470	3400 700 532	430 18	XTend Nabenprofil / Hub Profile: 45x50-18N Abgasnorm: Euro 6 / Exhaust Emission Norm: Euro 6 max. übertragbares Motormoment [Nm] / max. transmittable engine torque [Nm]: 1900 Nur zusammen verbauen / Only install together	(46) (4) (87) (51)	
			3400 700 530	430 18	XTend Getr. / GBox: Powershift Nabenprofil / Hub Profile: 45x50-18N Abgasnorm: Euro 6 / Exhaust Emission Norm: Euro 6 max. übertragbares Motormoment [Nm] / max. transmittable engine torque [Nm]: 1900 Nur zusammen verbauen / Only install together	(46) (4) (87) (51)	
			6482 000 218	PHIS-6/38	Getr. / GBox: Powershift Abgasnorm: Euro 6 / Exhaust Emission Norm: Euro 6 Immer erneuern / Renew everytime	(4) (28)	

MERCEDES-BENZ

AROCS		01.13 -					
1842	01.13-	OM471		3400 700 534 	430 18	XTend Nabenprofil / Hub Profile: 45x50-18N Abgasnorm: Euro 6 / Exhaust Emission Norm: Euro 6 max. übertragbares Motormoment [Nm] / max. transmittable engine torque [Nm]: 2600 Nur zusammen verbauen / Only install together	(46) (4) (87) (51)
964.000	01.13-						
1842 A	01.13-						
964.007	01.13-						
1842 AK	01.13-						
964.207	01.13-			3400 700 529 	430 18	XTend Getr. / GBox: Powershift Nabenprofil / Hub Profile: 45x50-18N Abgasnorm: Euro 6 / Exhaust Emission Norm: Euro 6 max. übertragbares Motormoment [Nm] / max. transmittable engine torque [Nm]: 2600 Nur zusammen verbauen / Only install together	(46) (4) (87) (51)
1842 AS	01.13-						
964.407	01.13-						
1842 K	01.13-						
964.200	01.13-						
1842 LS	01.13-						
964.403	01.13-						
2042	01.13-			6482 000 218	PHIS-6/38	Getr. / GBox: Powershift Abgasnorm: Euro 6 / Exhaust Emission Norm: Euro 6 Immer erneuern / Renew everytime	(4) (28)
964.001	01.13-						
2042 A	01.13-						
964.008	01.13-						
2042 AK	01.13-						
964.208	01.13-						
2042 AS	01.13-						
964.408	01.13-						
2042 K	01.13-						
964.201	01.13-						
2042 S, 2042 LS	01.13-						
964.401/402	01.13-						
2542 L	01.13-						
964.020	01.13-						
2542 LS	01.13-						
964.420	01.13-						
2542 LS	01.13-						
964.423	01.13-						
2642 B, 2642 LB	01.13-						
964.324 964.314	01.13-						
2642 K, 2642 LK	01.13-						
964.224 964.214	01.13-						
2642 L	01.13-						
964.025	01.13-						
2642 LS	01.13-						
964.425	01.13-						
2642 S, 2642 LS	01.13-						
964.414 964.424	01.13-						
2642, 2642 L	01.13-						
964.024 964.014	01.13-						
3242 B, 3242 LB	01.13-						
964.330 964.338	01.13-						
3242 K, 3242 LK	01.13-						
964.238 964.230	01.13-						
3242 L	01.13-						
964.041	01.13-						
3242 LB	01.13-						
964.341	01.13-						
3242 LK	01.13-						
964.241	01.13-						
3242, 3242 L	01.13-						
964.030 964.038	01.13-						
3342 A	01.13-						
964.018	01.13-						
3342 AK	01.13-						
964.218	01.13-						
3342 AS	01.13-						
964.418	01.13-						
3342 B, 3342 LB	01.13-						
964.326 964.316	01.13-						
3342 K, 3342 LK	01.13-						
964.226 964.216	01.13-						
3342 S, 3342 LS	01.13-						
964.426 964.416	01.13-						



















		CODE				
--	--	------	--	---	---	---

MERCEDES-BENZ

AROCS		01.13 -						
3342, 3342 L 964.026 964.016 4142 964.031 4142 AK 964.232 4142 AK 964.233 4142 B 964.331 4142 K 964.231	01.13-	OM471		3400 700 534 	430 18	XTend Nabenprofil / Hub Profile: 45x50-18N Abgasnorm: Euro 6 / Exhaust Emission Norm: Euro 6 max. übertragbares Motormoment [Nm] / max. transmittable engine torque [Nm]: 2600 Nur zusammen verbauen / Only install together	(46) (4) (87) (51)	
	01.13-			3400 700 529 	430 18	XTend Getr. / GBox: Powershift Nabenprofil / Hub Profile: 45x50-18N Abgasnorm: Euro 6 / Exhaust Emission Norm: Euro 6 max. übertragbares Motormoment [Nm] / max. transmittable engine torque [Nm]: 2600 Nur zusammen verbauen / Only install together	(46) (4) (87) (51)	
	01.13-			6482 000 218	PHIS-6/38	Getr. / GBox: Powershift Abgasnorm: Euro 6 / Exhaust Emission Norm: Euro 6 Immer erneuern / Renew everytime	(4) (28)	
	01.13-							
ACTROS 1824 - 1861		04.96 -						
ACTROS 1852 - 4163 OM473 min:2600NM Euro 6	01.13-	OM473		3400 700 534 	430 18	XTend für / for: max. 520 PS Nabenprofil / Hub Profile: 45x50-18N Abgasnorm: Euro 6 / Exhaust Emission Norm: Euro 6 max. übertragbares Motormoment [Nm] / max. transmittable engine torque [Nm]: 2600 Nur zusammen verbauen / Only install together	(68) (46) (4) (87) (51)	
				3400 700 609  3488 000 366 1878 007 185 3151 001 083	400 18 MFZ2/400X 400WGTZ KZISZ-5	Abgasnorm: Euro 6 / Exhaust Emission Norm: Euro 6	(4)	
				3400 700 529 	430 18	XTend für / for: max. 520 PS Getr. / GBox: Powershift Nabenprofil / Hub Profile: 45x50-18N Abgasnorm: Euro 6 / Exhaust Emission Norm: Euro 6 max. übertragbares Motormoment [Nm] / max. transmittable engine torque [Nm]: 2600 Nur zusammen verbauen / Only install together	(68) (46) (4) (87) (51)	
				3400 700 535 	400 MF2/400E	XTend Getr. / GBox: Powershift Abgasnorm: Euro 6 / Exhaust Emission Norm: Euro 6 Nur zusammen verbauen / Only install together	(4) (51)	
				6482 000 218	PHIS-6/38	Getr. / GBox: Powershift Abgasnorm: Euro 6 / Exhaust Emission Norm: Euro 6 Immer erneuern / Renew everytime	(4) (28)	
1824 L 963.003/004 1824 LS 963.403 963.406 963.404 1827 L 963.003/004 1827 LS 963.406 963.403 1830 L 963.003/004 1830 LS 963.403 963.406 1832 L 963.003/004 1832 LS 963.406 963.403/404 1835 L 963.003/004 1835 LS 963.406 963.403	07.11-	OM936		3400 700 533 	430 18	XTend Nabenprofil / Hub Profile: 45x50-18N Abgasnorm: Euro 6 / Exhaust Emission Norm: Euro 6 max. übertragbares Motormoment [Nm] / max. transmittable engine torque [Nm]: 2100 Nur zusammen verbauen / Only install together	(46) (4) (87) (51)	
	07.11-			3400 700 531 	430 18	XTend Getr. / GBox: Powershift Nabenprofil / Hub Profile: 45x50x-18N Abgasnorm: Euro 6 / Exhaust Emission Norm: Euro 6 max. übertragbares Motormoment [Nm] / max. transmittable engine torque [Nm]: 2100 Nur zusammen verbauen / Only install together	(46) (4) (87) (51)	
	07.11-			6482 000 218	PHIS-6/38	Getr. / GBox: Powershift Abgasnorm: Euro 6 / Exhaust Emission Norm: Euro 6 Immer erneuern / Renew everytime	(4) (28)	
	07.11-							
	07.11-							











		CODE				
--	--	------	--	---	---	---

MERCEDES-BENZ

ACTROS 1824 - 1861		04.96 -					
1831 AK 952.073 952.072	04.97 - 10.02	OM501LA	 3400 122 801 ⊕ ⊗ 3483 030 032 ⊙ 1878 005 165	430 18 MFZ430 430WGTZ	950.004/006/034/036 954.002-003/032-033/042 Je nach Kundenwunsch mit unterschiedlicher Kupplung / Equipped with different clutch according to customer requirement	(33)	
			 3400 121 501 ⊕ ⊗ 3488 023 031 ⊙ 1878 002 024	400 18 MFZ2/400X 400WGTZ	950.004/006/034/036 954.002-003/032-033/042 Nabenprofil / Hub Profile: 45x50-18N Je nach Kundenwunsch mit unterschiedlicher Kupplung / Equipped with different clutch according to customer requirement	(46) (33)	
			 3400 700 416 ⊕ ⊗ 3483 000 139 ⊙ 1878 005 165	430 18 GMFZ430N 430WGTZ	950.004/006/034/036 954.002-003/032-033/042 für Nebenantrieb / for PTO	(82)	
			 3400 122 801 ⊕ ⊗ 3483 030 032 ⊙ 1878 005 165	430 18 MFZ430 430WGTZ	für / for: SA504682/15 952.073	(68)	
		OM541.941, OM541.926	 3400 122 801 ⊕ ⊗ 3483 030 032 ⊙ 1878 005 165	430 18 MFZ430 430WGTZ	Je nach Kundenwunsch mit unterschiedlicher Kupplung / Equipped with different clutch according to customer requirement	(33)	
		OM502LA	 3400 700 415 ⊕ ⊗ 3483 030 032 ⊙ 1878 002 732	430 18 MFZ430 430WGTZ	für / for: SA504682-04 952.073	(68)	
1831 K 952.003 952.002	04.97 - 10.02	OM541.920, OM541.940	 3400 122 801 ⊕ ⊗ 3483 030 032 ⊙ 1878 005 165	430 18 MFZ430 430WGTZ	Je nach Kundenwunsch mit unterschiedlicher Kupplung / Equipped with different clutch according to customer requirement	(33)	
			 3400 121 501 ⊕ ⊗ 3488 023 031 ⊙ 1878 002 024	400 18 MFZ2/400X 400WGTZ	Nabenprofil / Hub Profile: 45x50-18N Je nach Kundenwunsch mit unterschiedlicher Kupplung / Equipped with different clutch according to customer requirement	(46) (33)	
1831, 1831 L 950.004 950.032 950.047 950.056 950.036 950.008 950.034 950.037 950.046 950.031 950.038 950.044 950.007 950.033 950.005/006 950.057 950.035 950.003 1835, 1835 L 950.031 950.057 950.004 950.032 950.037/038 950.044 950.003 950.033 950.035 950.008 950.006 950.046/047 950.056 950.007 950.034 950.036 950.005	04.96 - 10.02	OM501LA	 3400 122 701 ⊕ ⊗ 3483 030 031 ⊙ 1878 005 165	430 18 MFZ430 430WGTZ	950.003-008/034-038/044/046 954.002-003/032-033/042 Je nach Kundenwunsch mit unterschiedlicher Kupplung / Equipped with different clutch according to customer requirement	(33)	
			 3400 121 501 ⊕ ⊗ 3488 023 031 ⊙ 1878 002 024	400 18 MFZ2/400X 400WGTZ	950.003-008/034-038/044/046 954.002-003/032-033/042 Nabenprofil / Hub Profile: 45x50-18N Je nach Kundenwunsch mit unterschiedlicher Kupplung / Equipped with different clutch according to customer requirement	(46) (33)	
			 3400 700 416 ⊕ ⊗ 3483 000 139 ⊙ 1878 005 165	430 18 GMFZ430N 430WGTZ	950.003-008/034-038/044/046 954.002-003/032-033/042 für Nebenantrieb / for PTO	(82)	
			 3400 122 801 ⊕ ⊗ 3483 030 032 ⊙ 1878 005 165	430 18 MFZ430 430WGTZ	für / for: SA504682/15 950.004/006/057	(68)	
			OM502LA	 3400 700 415 ⊕ ⊗ 3483 030 032 ⊙ 1878 002 732	430 18 MFZ430 430WGTZ	für / for: SA504682-04 950.004/006/032/034/036	(68)
1831 S, 1831 LS 954.032/033 954.002/003 954.042 954.053 954.062 1835 S, 1835 LS 954.003 954.042 954.033 954.002 954.032 954.053 954.062	04.96 - 10.02	OM501LA	 3400 122 701 ⊕ ⊗ 3483 030 031 ⊙ 1878 005 165	430 18 MFZ430 430WGTZ	950.003-008/034-038/044/046 954.002-003/032-033/042 Je nach Kundenwunsch mit unterschiedlicher Kupplung / Equipped with different clutch according to customer requirement	(33)	
			 3400 121 501 ⊕ ⊗ 3488 023 031 ⊙ 1878 002 024	400 18 MFZ2/400X 400WGTZ	950.003-008/034-038/044/046 954.002-003/032-033/042 Nabenprofil / Hub Profile: 45x50-18N Je nach Kundenwunsch mit unterschiedlicher Kupplung / Equipped with different clutch according to customer requirement	(46) (33)	
			 3400 700 416 ⊕ ⊗ 3483 000 139 ⊙ 1878 005 165	430 18 GMFZ430N 430WGTZ	950.003-008/034-038/044/046 954.002-003/032-033/042 für Nebenantrieb / for PTO	(82)	
			 3400 122 801 ⊕ ⊗ 3483 030 032 ⊙ 1878 005 165	430 18 MFZ430 430WGTZ	für / for: SA504682/15 954.002-003/032-033/042/053/062	(68)	
			OM502LA	 3400 700 415 ⊕ ⊗ 3483 030 032 ⊙ 1878 002 732	430 18 MFZ430 430WGTZ	für / for: SA504682-04 954.002-003/032-033	(68)









		CODE				
--	--	------	--	---	---	---

MERCEDES-BENZ

ACTROS 1824 - 1861		04.96 -				
1832, L, LL 930.044 930.057 930.003 930.007/008 930.031 930.047 930.036 930.046 930.004-006 930.035 930.056 930.038 930.032-034 930.037	04.03-	OM501LA	 3400 122 801 ⊕ ⊕ 3483 030 032 ⊕ 1878 005 165	430 18 MFZ430 430WGTZ		
		OM502LA	 3400 700 415 ⊕ ⊕ 3483 030 032 ⊕ 1878 002 732	430 18 MFZ430 430WGTZ		
1836, L, LL 930.037 930.003 930.005 930.008 930.056 930.047 930.044 930.033 930.046 930.004 930.034/035 930.006 930.036 930.057 930.007 930.038 930.031/032	04.03-	OM541.948, OM541.944, OM541.976, OM541.970, OM541.942, OM541.974, OM541.946, OM541.978, OM541.980, OM541.940	 3400 122 801 ⊕ ⊕ 3483 030 032 ⊕ 1878 005 165	430 18 MFZ430 430WGTZ	für / for: SA 591014-09 für / for: SA 504682-26 für / for: SA 504682-27	(68) (68) (68)
		 3400 700 446 ⊕ ⊕ 3483 000 258 ⊕ 1878 005 165	430 18 MFZ430 430WGTZ	für / for: SA 504682-22/24	(68)	
1841, L, LL 930.008 930.047 930.056 930.003 930.038 930.006 930.031 930.007 930.032 930.044 930.004 930.034/035 930.005 930.037 930.046 930.057 930.033 930.036	04.03-	OM541.946, OM541.978, OM541.980, OM541.940	 3400 700 415 ⊕ ⊕ 3483 030 032 ⊕ 1878 002 732	430 18 MFZ430 430WGTZ	für / for: SA 504682-28	(68)
		 3400 700 416 ⊕ ⊕ 3483 000 139 ⊕ 1878 005 165	430 18 GMFZ430N 430WGTZ	für Nebenantrieb / for PTO	(82)	
1844, L, LL 930.008 930.034 930.036 930.006 930.032/033 930.037 930.047 930.031 930.035 930.004 930.007 930.038 930.044 930.056 930.003 930.005 930.046 930.057	04.03-		 3400 121 501 ⊕ ⊕ 3488 023 031 ⊕ 1878 002 024	400 18 MFZ2/400X 400WGTZ	Nabenprofil / Hub Profile: 45x50-18N für Fahrzeuge mit Zweis Scheibenkupplung / for vehicles with double disc clutch	(46) (77)
		 3400 700 355 ⊕ ⊕ 3488 000 158 ⊕ 1878 002 019	400 18 MFZ2/400X 400WGTZ	für / for: SA 504682-25 für Fahrzeuge mit Zweis Scheibenkupplung / for vehicles with double disc clutch	(68) (77)	
1846, L, LL 930.035/036 930.038 930.005 930.033/034 930.056 930.047 930.003 930.006 930.032 930.046 930.008 930.004 930.031 930.044 930.007 930.057 930.037	04.03-		 3488 000 102 ⊕	400 GMFZ2/ 400N	für Nebenantrieb / for PTO für Fahrzeuge mit Zweis Scheibenkupplung / for vehicles with double disc clutch enthält eine Kupplungsscheibe / This part number includes one clutch disc	(82) (77) (66)
		 1878 002 024 ▽	400 18 400WGTZ	für Nebenantrieb / for PTO für Fahrzeuge mit Zweis Scheibenkupplung / for vehicles with double disc clutch Lose Kupplungsscheibe / Loose clutch disc	(82) (77) (39)	
1848, L, LL 930.004-008 930.032 930.038 930.036 930.033 930.037 930.047 930.046 930.031 930.034/035 930.044 930.003	04.03-		 1863 869 028		für / for: SA 505120-01	(68)

















		CODE					
--	--	------	--	--	---	---	---

MERCEDES-BENZ

ACTROS 1824 - 1861		04.96 -					
1832 AK 932.073 932.072	04.03-		 3400 122 801 ⊕ ⊗ 3483 030 032 ⊗ 1878 005 165	430 18 MFZ430 430WGTZ			
1832 K 932.002/003	04.03-		 3400 700 416 ⊕ ⊗ 3483 000 139 ⊗ 1878 005 165	430 18 GMFZ430N 430WGTZ	für Nebenantrieb / for PTO		(82)
1832 LS, LLS 934.032/033 934.042 934.053 934.062 934.031	04.03-		 3400 700 446 ⊕ ⊗ 3483 000 258 ⊗ 1878 005 165	430 18 MFZ430 430WGTZ	für / for: SA 504682 24		(68)
1836 AK 932.073 932.072	04.03-		 3400 121 501 ⊕ ⊗ 3488 023 031 ⊗ 1878 002 024	400 18 MFZ2/400X 400WGTZ	Nabenprofil / Hub Profile: 45x50-18N für Fahrzeuge mit Zweis Scheibenkupplung / for vehicles with double disc clutch		(46) (77)
1836 K 932.003 932.002	04.03-		 3400 700 355 ⊕ ⊗ 3488 000 158 ⊗ 1878 002 019	400 18 MFZ2/400X 400WGTZ	für / for: SA 504682-25 für / for: SA 591014-08 für Fahrzeuge mit Zweis Scheibenkupplung / for vehicles with double disc clutch		(68) (68) (77)
1836 LS, LLS 934.053 934.031 934.033 934.062 934.042 934.032	04.03-						
1841 K 932.002/003	04.03-						
1841 L, LL 932.002/003	04.03-						
1841 LS, LLS 934.053 934.033 934.062 934.032 934.031	04.03-						
1844 AK 932.072/073	04.03-						
1844 K 932.003 932.002	04.03-						
1844 LS, LLS 934.033 934.031/032 934.042 934.053 934.062	04.03-						
1846 AK 932.072/073	04.03-						
1846 K 932.002/003	04.03-						
1846 LS, LLS 934.042 934.032/033 934.031 934.053 934.062	04.03-						
1848 AK 932.073 932.072 932.083	04.03-						
1848 K 932.003 932.002	04.03-						
1848, LS, LLS 934.042 934.053 934.033 934.032	04.03-						
1833 L 963.005 963.004 963.003	07.11-	OM470	 3400 700 532 ⊕ ⊗ 3488 000 218	430 18	XTend Nabenprofil / Hub Profile: 45x50-18N Abgasnorm: Euro 6 / Exhaust Emission Norm: Euro 6 max. übertragbares Motormoment [Nm] / max. transmittable engine torque [Nm]: 1900 Nur zusammen verbauen / Only install together		(46) (4) (87) (51)
1833 LS 963.405/406 963.404 963.403	07.11-		 3400 700 530 ⊕ ⊗ 3488 000 218	430 18	XTend Getr. / GBox: Powershift Nabenprofil / Hub Profile: 45x50-18N Abgasnorm: Euro 6 / Exhaust Emission Norm: Euro 6 max. übertragbares Motormoment [Nm] / max. transmittable engine torque [Nm]: 1900 Nur zusammen verbauen / Only install together		(46) (4) (87) (51)
1836 L 963.004 963.003	07.11-						
1836 LS 963.403-406	07.11-						
1840 L 963.005 963.003/004	07.11-						
1840 LS 963.404/405 963.403 963.406	07.11-						
1843 L 963.005 963.003/004	07.11-		 6482 000 218	PHIS-6/38	Getr. / GBox: Powershift Abgasnorm: Euro 6 / Exhaust Emission Norm: Euro 6 Immer erneuern / Renew everytime		(4) (28)
1843 LS 963.405/406 963.403/404	07.11-						























		CODE				
--	--	------	--	---	---	---

MERCEDES-BENZ

ACTROS 1824 - 1861		04.96 -					
1835 AK 952.073	04.97 - 10.02	OM541.923,		3400 122 801 ⊕ ⊗ 3483 030 032 ⊗ 1878 005 165	430 18 MFZ430 430WGTZ		
1835 K 952.003	04.97 - 10.02	OM541.944, OM541.945, OM541.921, OM541.947,					
1840 AK 952.073	04.97 - 10.02	OM541.942, OM541.922, OM541.927, OM541.946,					
1840 K 952.003	04.97 - 10.02	OM541.943, OM541.943, OM541.924, OM541.925					
1843 AK 952.073	04.97 - 10.02						
1843 K 952.003	04.97 - 10.02						
1840, 1840 L 950.007 950.006 950.032 950.034 950.031 950.004 950.056 950.035-037 950.047 950.057 950.044 950.046	04.96 - 10.02	OM541.923		3400 122 801 ⊕ ⊗ 3483 030 032 ⊗ 1878 005 165	430 18 MFZ430 430WGTZ		
				3400 700 416 ⊕ ⊗ 3483 000 139 ⊗ 1878 005 165	430 18 GMFZ430N 430WGTZ	für Nebenantrieb / for PTO	(82)
1840 S, 1840 LS 954.032/033 954.042 954.062 954.002 954.053 954.003	04.96 - 10.02	OM541.923, OM541.944, OM541.946, OM541.925		3400 122 801 ⊕ ⊗ 3483 030 032 ⊗ 1878 005 165	430 18 MFZ430 430WGTZ	Je nach Kundenwunsch mit unterschiedlicher Kupplung / Equipped with different clutch according to customer requirement	(33)
1843, 1843 L 950.032 950.034 950.047 950.057 950.036 950.006 950.056 950.035 950.044 950.046 950.004	04.96 - 10.02			3400 121 501 ⊕ ⊗ 3488 023 031 ⊗ 1878 002 024	400 18 MFZ2/400X 400WGTZ	Nabenprofil / Hub Profile: 45x50-18N Je nach Kundenwunsch mit unterschiedlicher Kupplung / Equipped with different clutch according to customer requirement	(46) (33)
1843 S, 1843 LS 954.003 954.032 954.053 954.062 954.002 954.033 954.042	04.96 - 10.02			3400 700 416 ⊕ ⊗ 3483 000 139 ⊗ 1878 005 165	430 18 GMFZ430N 430WGTZ	für Nebenantrieb / for PTO	(82)
1842 L 963.005 963.003/004	07.11 -	OM471		3400 700 534 ⊕ ⊗	430 18	XTend Nabenprofil / Hub Profile: 45x50-18N Abgasnorm: Euro 6 / Exhaust Emission Norm: Euro 6 max. übertragbares Motormoment [Nm] / max. transmittable engine torque [Nm]: 2600 Nur zusammen verbauen / Only install together	(46) (4) (87)
1842 LS 963.403/404 963.406	07.11 -						
1845 L 963.004/005 963.003	07.11 -			3400 700 529 ⊕ ⊗	430 18	XTend Getr. / GBox: Powershift Nabenprofil / Hub Profile: 45x50-18N Abgasnorm: Euro 6 / Exhaust Emission Norm: Euro 6 max. übertragbares Motormoment [Nm] / max. transmittable engine torque [Nm]: 2600 Nur zusammen verbauen / Only install together	(46) (4) (87)
1845 LS 963.404 963.403 963.405/406	07.11 -						
1848 L 963.004/005 963.003	07.11 -			6482 000 218	PHIS-6/38	Getr. / GBox: Powershift Abgasnorm: Euro 6 / Exhaust Emission Norm: Euro 6 Immer erneuern / Renew everytime	(4) (28)
1848 LS 963.404 963.403 963.406 963.405	07.11 -						
1851 L 963.004 963.003	07.11 -						
1851 LS 963.404 963.403 963.406	07.11 -						
1848, 1848 L 950.034 950.004 950.006 950.036 950.032	04.96 - 10.02	OM501LA		3400 122 801 ⊕ ⊗ 3483 030 032 ⊗ 1878 005 165	430 18 MFZ430 430WGTZ	für / for: SA504682/15 950.004/006	(68)
1853, 1853 L 950.004 950.006 950.032 950.034 950.036	04.96 - 10.02	OM502LA		3400 121 501 ⊕ ⊗ 3488 023 031 ⊗ 1878 002 024	400 18 MFZ2/400X 400WGTZ	950.004/006/034/036 954.002-003/032-033 Nabenprofil / Hub Profile: 45x50-18N	(46)
				3400 700 415 ⊕ ⊗ 3483 030 032 ⊗ 1878 002 732	430 18 MFZ430 430WGTZ	für / for: SA504682-04 950.004/006/032/034/036	(68)
				3400 700 416 ⊕ ⊗ 3483 000 139 ⊗ 1878 005 165	430 18 GMFZ430N 430WGTZ	950.004/006/034/036 954.002-003/032-033 für Nebenantrieb / for PTO	(82)
				3488 000 102 ⊕	400 GMFZ2/ 400N	für / for: SA504682-08 950.004/006/032/034/036 für Nebenantrieb / for PTO enthält eine Kupplungsscheibe / This part number includes one clutch disc	(68) (82) (66)
				1878 002 024 ▽	400 18 400WGTZ	für / for: SA504682-08 950.004/006/032/034/036 für Nebenantrieb / for PTO Lose Kupplungsscheibe / Loose clutch disc	(68) (82) (39)
				1863 869 028		Lose Kupplungsscheibe / Loose clutch disc	(39)















		CODE					
--	--	------	--	--	---	---	---

MERCEDES-BENZ





























ACTROS 1824 - 1861		04.96 -						
1848, L, LL 930.004 930.032 930.034 930.036 1850, 1851, L, LL 930.034 930.004 930.036 930.032 1854, L 930.036 930.034 930.004 930.032 1858, L 930.034	04.03-	OM501LA		3400 122 801 ⊕ 3483 030 032 1878 005 165	430 18 MFZ430 430WGTZ			
	04.03-	OM502LA		3400 700 415 ⊕ 3483 030 032 1878 002 732	430 18 MFZ430 430WGTZ			
	04.03-	OM542.940, OM542.921, OM542.960, OM542.944, OM542.942, OM542.962		3400 122 801 ⊕ 3483 030 032 1878 005 165	430 18 MFZ430 430WGTZ	für / for: SA 591014-09 für / for: SA 504682-26 für / for: SA 504682-27	(68) (68) (68)	
	04.03-	OM542.940, OM542.921, OM542.960, OM542.944, OM542.942, OM542.962		3400 700 446 ⊕ 3483 000 258 1878 005 165	430 18 MFZ430 430WGTZ	für / for: SA 504682-22/24	(68)	
					3400 700 415 ⊕ 3483 030 032 1878 002 732	430 18 MFZ430 430WGTZ	für / for: SA 504682-28	(68)
					3400 700 416 ⊕ 3483 000 139 1878 005 165	430 18 GMFZ430N 430WGTZ	für Nebenantrieb / for PTO	(82)
					3400 121 501 ⊕ 3488 023 031 1878 002 024	400 18 MFZ2/400X 400WGTZ	Nabenprofil / Hub Profile: 45x50-18N für Fahrzeuge mit Zweischeibenkupplung / for vehicles with double disc clutch	(46) (77)
					3400 700 355 ⊕ 3488 000 158 1878 002 019	400 18 MFZ2/400X 400WGTZ	für / for: SA 504682-25 für Fahrzeuge mit Zweischeibenkupplung / for vehicles with double disc clutch	(68) (77)
					3488 000 102 ⊕	400 GMFZ2/ 400N	für Nebenantrieb / for PTO für Fahrzeuge mit Zweischeibenkupplung / for vehicles with double disc clutch enthält eine Kupplungsscheibe / This part number includes one clutch disc	(82) (77) (66)
					1878 002 024 ▽	400 18 400WGTZ	für Nebenantrieb / for PTO für Fahrzeuge mit Zweischeibenkupplung / for vehicles with double disc clutch Lose Kupplungsscheibe / Loose clutch disc	(82) (77) (39)
					3400 700 468 ⊕ 3483 000 422 1878 006 101	430 18 MFZ430 430WGTZ	Motorbauart / Engine Model: V8 Abgasnorm: Euro 4 (D4) / Exhaust Emission Norm: Euro 4 (D4)	(45) (2)
					1863 869 028		für / for: SA 505120-01	(68)
	1848 AK 952.073 1848 K 952.003	04.97 - 10.02	OM501LA		3400 122 801 ⊕ 3483 030 032 1878 005 165	430 18 MFZ430 430WGTZ	für / for: SA504682/15	(68)
04.97 - 10.02		OM502LA		3400 700 415 ⊕ 3483 030 032 1878 002 732	430 18 MFZ430 430WGTZ	für / for: SA504682-04	(68)	
				3488 000 102 ⊕	400 GMFZ2/ 400N	für / for: SA504682-08 für Nebenantrieb / for PTO enthält eine Kupplungsscheibe / This part number includes one clutch disc	(68) (82) (66)	
					1878 002 024 ▽	400 18 400WGTZ	für / for: SA504682-08 für Nebenantrieb / for PTO Lose Kupplungsscheibe / Loose clutch disc	(68) (82) (39)
1848 S, 1848 LS 954.033 954.002/003 954.032 1853 S, 1853 LS 954.033 954.032 954.003 954.002	04.96 - 10.02	OM501LA		3400 122 801 ⊕ 3483 030 032 1878 005 165	430 18 MFZ430 430WGTZ	für / for: SA504682/15 954.002-003/032-033	(68)	
	04.96 - 10.02	OM502LA		3400 121 501 ⊕ 3488 023 031 1878 002 024	400 18 MFZ2/400X 400WGTZ	950.004/006/034/036 954.002-003/032-033 Nabenprofil / Hub Profile: 45x50-18N	(46)	
				3400 700 416 ⊕ 3483 000 139 1878 005 165	430 18 GMFZ430N 430WGTZ	950.004/006/034/036 954.002-003/032-033 für Nebenantrieb / for PTO	(82)	
				3400 700 415 ⊕ 3483 030 032 1878 002 732	430 18 MFZ430 430WGTZ	für / for: SA504682-04 954.002-003/032-033	(68)	
				3488 000 102 ⊕	400 GMFZ2/ 400N	für / for: SA504682-08 954.002-003/032-033 für Nebenantrieb / for PTO enthält eine Kupplungsscheibe / This part number includes one clutch disc	(68) (82) (66)	
				1878 002 024 ▽	400 18 400WGTZ	für / for: SA504682-08 954.002-003/032-033 für Nebenantrieb / for PTO Lose Kupplungsscheibe / Loose clutch disc	(68) (82) (39)	
				1863 869 028		Lose Kupplungsscheibe / Loose clutch disc	(39)	

		CODE				
--	--	------	--	---	---	---

MERCEDES-BENZ

















ACTROS 1824 - 1861		04.96 -					
1848 S, LS 934.033 934.032 1860 L, LL 930.034 1860 LS 934.033 934.032	04.03-	OM542.921, OM542.964		3400 700 468 ⊕ ⊗ 3483 000 422 ● 1878 006 101	430 18 MFZ430 430WGTZ	Motorbauart / Engine Model: V8 Abgasnorm: Euro 4 (D4) / Exhaust Emission Norm: Euro 4 (D4)	(45) (2)
	05.05-						
	06.08-						
1850, 1851 AK 932.073 1850, 1851 K 932.003 1854 LS 934.032/033	04.03-	OM542.940, OM542.941, OM542.960, OM542.942, OM542.961		3400 700 415 ⊕ ⊗ 3483 030 032 ● 1878 002 732	430 18 MFZ430 430WGTZ		
	04.03-			3488 000 102 ⊕	400 GMFZ2/ 400N	für Nebenantrieb / for PTO enthält eine Kupplungsscheibe / This part number includes one clutch disc	(82) (66)
	04.03-			1878 002 024 ▽	400 18 400WGTZ	für Nebenantrieb / for PTO Lose Kupplungsscheibe / Loose clutch disc	(82) (39)
				3400 121 501 ⊕ ⊗ 3488 023 031 ● 1878 002 024	400 18 MFZ2/400X 400WGTZ	Nabenprofil / Hub Profile: 45x50-18N für Fahrzeuge mit Zweis Scheibenkupplung / for vehicles with double disc clutch	(46) (77)
				3400 700 355 ⊕ ⊗ 3488 000 158 ● 1878 002 019	400 18 MFZ2/400X 400WGTZ	für / for: SA 504682-25 für / for: SA 591014-08 für Fahrzeuge mit Zweis Scheibenkupplung / for vehicles with double disc clutch	(68) (68) (77)
1850, 1851 LS, LLS 934.033 934.032 1858 LS 934.032	04.03-	OM542.940, OM542.960, OM542.944		3400 700 415 ⊕ ⊗ 3483 030 032 ● 1878 002 732	430 18 MFZ430 430WGTZ		
	10.02-			3488 000 102 ⊕	400 GMFZ2/ 400N	für Nebenantrieb / for PTO enthält eine Kupplungsscheibe / This part number includes one clutch disc	(82) (66)
				1878 002 024 ▽	400 18 400WGTZ	für Nebenantrieb / for PTO Lose Kupplungsscheibe / Loose clutch disc	(82) (39)
				3400 121 501 ⊕ ⊗ 3488 023 031 ● 1878 002 024	400 18 MFZ2/400X 400WGTZ	Nabenprofil / Hub Profile: 45x50-18N für Fahrzeuge mit Zweis Scheibenkupplung / for vehicles with double disc clutch	(46) (77)
				3400 700 355 ⊕ ⊗ 3488 000 158 ● 1878 002 019	400 18 MFZ2/400X 400WGTZ	für / for: SA 504682-25 für / for: SA 591014-08 für Fahrzeuge mit Zweis Scheibenkupplung / for vehicles with double disc clutch	(68) (68) (77)
1857 L 950.034 1857 LS 954.032/033	04.97 - 10.02	OM502LA		3400 121 501 ⊕ ⊗ 3488 023 031 ● 1878 002 024	400 18 MFZ2/400X 400WGTZ	Nabenprofil / Hub Profile: 45x50-18N	(46)
	04.97 - 10.02			3400 700 416 ⊕ ⊗ 3483 000 139 ● 1878 005 165	430 18 GMFZ430N 430WGTZ	für Nebenantrieb / for PTO	(82)
				3488 000 102 ⊕	400 GMFZ2/ 400N	für / for: SA504682-08 für Nebenantrieb / for PTO enthält eine Kupplungsscheibe / This part number includes one clutch disc	(68) (82) (66)
				1878 002 024 ▽	400 18 400WGTZ	für / for: SA504682-08 für Nebenantrieb / for PTO Lose Kupplungsscheibe / Loose clutch disc	(68) (82) (39)

MERCEDES-BENZ

ACTROS 2024 - 2055		04.96 -		
2024 L 963.002	07.11 -	OM936	 3400 700 533  430 18 XTend Nabenprofil / Hub Profile: 45x50-18N Abgasnorm: Euro 6 / Exhaust Emission Norm: Euro 6 max. übertragbares Motormoment [Nm] / max. transmittable engine torque [Nm]: 2100 Nur zusammen verbauen / Only install together	(46) (4) (87)
2024 LS 963.402	07.11 -			
2027 L 963.002	07.11 -		 3400 700 531  430 18 XTend Getr. / GBox: Powershift Nabenprofil / Hub Profile: 45x50x-18N Abgasnorm: Euro 6 / Exhaust Emission Norm: Euro 6 max. übertragbares Motormoment [Nm] / max. transmittable engine torque [Nm]: 2100 Nur zusammen verbauen / Only install together	(46) (4) (87) (51)
2027 LS 963.402	07.11 -			
2030 L 963.002	07.11 -			
2030 LS 963.402	07.11 -			
2032 L 963.002	07.11 -		 6482 000 218 PHIS-6/38 Getr. / GBox: Powershift Abgasnorm: Euro 6 / Exhaust Emission Norm: Euro 6 Immer erneuern / Renew everytime	(4) (28)
2032 LS 963.402	07.11 -			
2035 L 963.002	07.11 -			
2035 LS 963.402	07.11 -			
2031 950.013 950.016 950.014	04.97 - 10.02	OM502LA	 3400 700 415   3483 030 032  1878 002 732 430 18 MFZ430 430WGTZ für / for: SA504682-04 950.014	(68)
2031 A 950.083	04.97 - 10.02	OM501LA	 3400 122 701   3483 030 031  1878 005 165 430 18 MFZ430 430WGTZ Je nach Kundenwunsch mit unterschiedlicher Kupplung / Equipped with different clutch according to customer requirement	(33)
2031 AK 952.083	09.96 - 10.02			
2031 AS 954.082	04.96 - 10.02		 3400 121 501   3488 023 031  1878 002 024 400 18 MFZ2/400X 400WGTZ Nabenprofil / Hub Profile: 45x50-18N Je nach Kundenwunsch mit unterschiedlicher Kupplung / Equipped with different clutch according to customer requirement	(46) (33)
2031 K 952.013	04.97 - 10.02		 3400 700 416   3483 000 139  1878 005 165 430 18 GMFZ430N 430WGTZ für Nebenantrieb / for PTO	(82)
2031 S 954.012	04.96 - 10.02		 3400 122 801   3483 030 032  1878 005 165 430 18 MFZ430 430WGTZ für / for: SA504682/15	(68)
		OM502LA	 3400 700 415   3483 030 032  1878 002 732 430 18 MFZ430 430WGTZ für / for: SA504682-04	(68)



































		CODE				
--	--	------	--	---	---	---

MERCEDES-BENZ

ACTROS 2024 - 2055		04.96 -					
2032 930.013/014 930.016 2032 A, AE 930.083 2036 930.016 930.014 930.013 2036 A, AE 930.083 2041 930.013/014 2044 930.014 930.013 2046 930.014 930.013	04.03-	OM501LA	 3400 122 801 ⊕ ⊗ 3483 030 032 ⊙ 1878 005 165	430 18 MFZ430 430WGTZ			
	04.03-	OM502LA	 3400 700 415 ⊕ ⊗ 3483 030 032 ⊙ 1878 002 732	430 18 MFZ430 430WGTZ			
	04.03-	OM541.920, OM541.944, OM541.976, OM541.948, OM541.942, OM541.922, OM541.974,	 3400 122 801 ⊕ ⊗ 3483 030 032 ⊙ 1878 005 165	430 18 MFZ430 430WGTZ	für / for: SA 591014-09 für / for: SA 504682-26 für / for: SA 504682-27	(68) (68) (68)	
	04.03-	OM541.942, OM541.922, OM541.974, OM541.946, OM541.941, OM541.927, OM541.980, OM541.943, OM541.940, OM541.926	 3400 700 446 ⊕ ⊗ 3483 000 258 ⊙ 1878 005 165	430 18 MFZ430 430WGTZ	für / for: SA 504682-22/24	(68)	
	04.03-		 3400 700 415 ⊕ ⊗ 3483 030 032 ⊙ 1878 002 732	430 18 MFZ430 430WGTZ	für / for: SA 504682-28	(68)	
	04.03-		 3400 700 416 ⊕ ⊗ 3483 000 139 ⊙ 1878 005 165	430 18 GMFZ430N 430WGTZ	für Nebenantrieb / for PTO	(82)	
			 3400 121 501 ⊕ ⊗ 3488 023 031 ⊙ 1878 002 024	400 18 MFZ2/400X 400WGTZ	Nabenprofil / Hub Profile: 45x50-18N für Fahrzeuge mit Zweischeibenkupplung / for vehicles with double disc clutch	(46) (77)	
			 3400 700 355 ⊕ ⊗ 3488 000 158 ⊙ 1878 002 019	400 18 MFZ2/400X 400WGTZ	für / for: SA 504682-25 für Fahrzeuge mit Zweischeibenkupplung / for vehicles with double disc clutch	(68) (77)	
			 3488 000 102 ⊕	400 GMFZ2/ 400N	für Nebenantrieb / for PTO für Fahrzeuge mit Zweischeibenkupplung / for vehicles with double disc clutch enthält eine Kupplungsscheibe / This part number includes one clutch disc	(82) (77) (66)	
			 1878 002 024 ▽	400 18 400WGTZ	für Nebenantrieb / for PTO für Fahrzeuge mit Zweischeibenkupplung / for vehicles with double disc clutch Lose Kupplungsscheibe / Loose clutch disc	(82) (77) (39)	
			 1863 869 028		für / for: SA 505120-01	(68)	
	2032 AK 932.083 2032 AS 934.082 2032 K 932.013 2032 S 934.013 934.012 2036 AK 932.083 2036 AS 934.082/083 2036 S 934.012/013 2041 AK 932.083 2041 AS 934.082 2041 K 932.013 2041 S 934.013 934.012 2044 AS 934.082 2044 AK 932.083 2044 S 934.013 934.012 2046 AK 932.083 2046 S 934.012/013 2048 AK 932.083 2048 AS 934.082	04.03-		 3400 122 801 ⊕ ⊗ 3483 030 032 ⊙ 1878 005 165	430 18 MFZ430 430WGTZ		
		04.03-		 3400 700 416 ⊕ ⊗ 3483 000 139 ⊙ 1878 005 165	430 18 GMFZ430N 430WGTZ	für Nebenantrieb / for PTO	(82)
04.03-			 3400 700 446 ⊕ ⊗ 3483 000 258 ⊙ 1878 005 165	430 18 MFZ430 430WGTZ	für / for: SA 504682 24	(68)	
04.03-			 3400 121 501 ⊕ ⊗ 3488 023 031 ⊙ 1878 002 024	400 18 MFZ2/400X 400WGTZ	Nabenprofil / Hub Profile: 45x50-18N für Fahrzeuge mit Zweischeibenkupplung / for vehicles with double disc clutch	(46) (77)	
04.03-			 3400 700 355 ⊕ ⊗ 3488 000 158 ⊙ 1878 002 019	400 18 MFZ2/400X 400WGTZ	für / for: SA 504682-25 für / for: SA 591014-08 für Fahrzeuge mit Zweischeibenkupplung / for vehicles with double disc clutch	(68) (68) (77)	
04.03-							
04.03-							
04.03-							
04.03-							
04.03-							
04.03-							
04.03-							
04.03-							

		CODE				
--	--	------	--	---	---	---





MERCEDES-BENZ

ACTROS 2024 - 2055		04.96 -					
2033 L 963.002 2033 LS 963.402 2036 L 963.002 2036 LS 963.402 2040 L 963.002 2040 LS 963.402 2043 L 963.002 2043 LS 963.402	07.11-	OM470		3400 700 532  	430 18	XTend Nabenprofil / Hub Profile: 45x50-18N Abgasnorm: Euro 6 / Exhaust Emission Norm: Euro 6 max. übertragbares Motormoment [Nm] / max. transmittable engine torque [Nm]: 1900 Nur zusammen verbauen / Only install together	(46) (4) (87) (51)
	07.11-			3400 700 530  	430 18	XTend Getr. / GBox: Powershift Nabenprofil / Hub Profile: 45x50-18N Abgasnorm: Euro 6 / Exhaust Emission Norm: Euro 6 max. übertragbares Motormoment [Nm] / max. transmittable engine torque [Nm]: 1900 Nur zusammen verbauen / Only install together	(46) (4) (87) (51)
	07.11-			6482 000 218	PHIS-6/38	Getr. / GBox: Powershift Abgasnorm: Euro 6 / Exhaust Emission Norm: Euro 6 Immer erneuern / Renew everytime	(4) (28)
	07.11-						
2035 A 950.083 2040 950.014 2040 AK 952.083 2040 AS 954.082 2040 S 954.012	04.97-10.02	OM501LA		3400 122 801  3483 030 032 1878 005 165	430 18 MFZ430 430WGTZ	Je nach Kundenwunsch mit unterschiedlicher Kupplung / Equipped with different clutch according to customer requirement	(33)
	09.96-10.02			3400 121 501  3488 023 031 1878 002 024	400 18 MFZ2/400X 400WGTZ	Nabenprofil / Hub Profile: 45x50-18N Je nach Kundenwunsch mit unterschiedlicher Kupplung / Equipped with different clutch according to customer requirement	(46) (33)
	09.96-10.02			3400 700 416  3483 000 139 1878 005 165	430 18 GMFZ430N 430WGTZ	für Nebenantrieb / for PTO	(82)
	04.96-10.02			3400 122 801  3483 030 032 1878 005 165	430 18 MFZ430 430WGTZ	für / for: SA504682/15	(68)
	04.96-10.02		OM502LA		3400 700 415  3483 030 032 1878 002 732	430 18 MFZ430 430WGTZ	für / for: SA504682-04
2042 L 963.002 2042 LS 963.402 2045 L 963.002 2045 LS 963.402 2048 L 963.002 2048 LS 963.402 2051 L 963.002 2051 LS 963.402	07.11-	OM471		3400 700 534  	430 18	XTend Nabenprofil / Hub Profile: 45x50-18N Abgasnorm: Euro 6 / Exhaust Emission Norm: Euro 6 max. übertragbares Motormoment [Nm] / max. transmittable engine torque [Nm]: 2600 Nur zusammen verbauen / Only install together	(46) (4) (87) (51)
	07.11-			3400 700 529  	430 18	XTend Getr. / GBox: Powershift Nabenprofil / Hub Profile: 45x50-18N Abgasnorm: Euro 6 / Exhaust Emission Norm: Euro 6 max. übertragbares Motormoment [Nm] / max. transmittable engine torque [Nm]: 2600 Nur zusammen verbauen / Only install together	(46) (4) (87) (51)
	07.11-			6482 000 218	PHIS-6/38	Getr. / GBox: Powershift Abgasnorm: Euro 6 / Exhaust Emission Norm: Euro 6 Immer erneuern / Renew everytime	(4) (28)
	07.11-						
2050 S 934.013 934.012 2051 AS 934.082	04.03-	OM542.940, OM542.941, OM542.960		3400 700 415  3483 030 032 1878 002 732	430 18 MFZ430 430WGTZ		
	04.03-			3488 000 102 	400 GMFZ2/ 400N	für Nebenantrieb / for PTO enthält eine Kupplungsscheibe / This part number includes one clutch disc	(82) (66)
				1878 002 024 	400 18 400WGTZ	für Nebenantrieb / for PTO Lose Kupplungsscheibe / Loose clutch disc	(82) (39)
				3400 121 501  3488 023 031 1878 002 024	400 18 MFZ2/400X 400WGTZ	Nabenprofil / Hub Profile: 45x50-18N für Fahrzeuge mit Zweischeibenkupplung / for vehicles with double disc clutch	(46) (77)
				3400 700 355  3488 000 158 1878 002 019	400 18 MFZ2/400X 400WGTZ	für / for: SA 504682-25 für / for: SA 591014-08 für Fahrzeuge mit Zweischeibenkupplung / for vehicles with double disc clutch	(68) (68) (77)











		CODE				
--	--	------	--	---	---	---

MERCEDES-BENZ

ACTROS 2024 - 2055 04.96 -

























2053 S 954.012	04.96 - 10.02	OM502LA	 3400 121 501 ⊕ ⊗ 3488 023 031 ⊗ 1878 002 024	400 18 MFZ2/400X 400WGTZ	954.012 Nabenprofil / Hub Profile: 45x50-18N	(46)
			 3400 700 415 ⊕ ⊗ 3483 030 032 ⊗ 1878 002 732	430 18 MFZ430 430WGTZ	für / for: SA504682-04 954.012	(68)
			 3400 700 416 ⊕ ⊗ 3483 000 139 ⊗ 1878 005 165	430 18 GMFZ430N 430WGTZ	954.012 für Nebenantrieb / for PTO	(82)
			 3488 000 102 ⊕	400 GMFZ2/ 400N	für / for: SA504682-08 954.012 für Nebenantrieb / for PTO enthält eine Kupplungsscheibe / This part number includes one clutch disc	(68) (82) (66)
			 1878 002 024 ▽	400 18 400WGTZ	für / for: SA504682-08 954.012 für Nebenantrieb / for PTO Lose Kupplungsscheibe / Loose clutch disc	(68) (82) (39)

ACTROS 2427 - 2455

2427 LS 963.427	07.11 -	OM936		3400 700 533  	430 18	XTend Nabenprofil / Hub Profile: 45x50-18N Abgasnorm: Euro 6 / Exhaust Emission Norm: Euro 6 max. übertragbares Motormoment [Nm] / max. transmittable engine torque [Nm]: 2100 Nur zusammen verbauen / Only install together	(46) (4) (87)											
								2430 LS 963.427	07.11 -	2432 LS 963.427	07.11 -	2435 LS 963.427	07.11 -		3400 700 531  	430 18	XTend Getr. / GBox: Powershift Nabenprofil / Hub Profile: 45x50x-18N Abgasnorm: Euro 6 / Exhaust Emission Norm: Euro 6 max. übertragbares Motormoment [Nm] / max. transmittable engine torque [Nm]: 2100 Nur zusammen verbauen / Only install together	(46) (4) (87) (51)
2442 LS 963.427	07.11 -	2445 LS 963.427	07.11 -	2448 LS 963.427	07.11 -		3400 700 534  	430 18	XTend Getr. / GBox: Powershift Nabenprofil / Hub Profile: 45x50-18N Abgasnorm: Euro 6 / Exhaust Emission Norm: Euro 6 max. übertragbares Motormoment [Nm] / max. transmittable engine torque [Nm]: 2600 Nur zusammen verbauen / Only install together	(46) (4) (87) (51)								
											2451 LS 963.427	07.11 -	2460 LS 934.235 934.233	06.08 -	OM542.964		3400 700 468 ⊕ ⊗ 3483 000 422 ⊗ 1878 006 101	430 18 MFZ430 430WGTZ











































		CODE				
--	--	------	--	---	---	---

MERCEDES-BENZ

ACTROS 2527 - 2560		06.96 -					
2527 L 963.020/021 2527 LS 963.423 2527 LS 963.420 2530 L 963.021 963.020 2530 LS 963.420 2530 LS 963.423 2532 L 963.020/021 2532 LS 963.420 2532 LS 963.423 2535 L 963.020/021 2535 LS 963.420 2535 LS 963.423	07.11-	OM936		3400 700 533 	430 18	XTend Nabenprofil / Hub Profile: 45x50-18N Abgasnorm: Euro 6 / Exhaust Emission Norm: Euro 6 max. übertragbares Motormoment [Nm] / max. transmittable engine torque [Nm]: 2100 Nur zusammen verbauen / Only install together	(46) (4) (87) (51)
	07.11-			3400 700 531 	430 18	XTend Getr. / GBox: Powershift Nabenprofil / Hub Profile: 45x50x-18N Abgasnorm: Euro 6 / Exhaust Emission Norm: Euro 6 max. übertragbares Motormoment [Nm] / max. transmittable engine torque [Nm]: 2100 Nur zusammen verbauen / Only install together	(46) (4) (87) (51)
	07.11-			6482 000 218	PHIS-6/38	Getr. / GBox: Powershift Abgasnorm: Euro 6 / Exhaust Emission Norm: Euro 6 Immer erneuern / Renew everytime	(4) (28)
	07.11-						
	07.11-						
	07.11-						
	07.11-						
	07.11-						
	07.11-						
	07.11-						
2531, 2531 L 950.208 950.203/204 950.225 950.224 950.205 950.226 950.114	09.96 - 10.02	OM501LA		3400 122 701   3483 030 031  1878 005 165	430 18 MFZ430 430WGTZ	950.203-205/224-225	
				3400 122 801   3483 030 032  1878 005 165	430 18 MFZ430 430WGTZ	für / for: SA504682/15 950.114/203-204-205	(68)
				3400 700 415   3483 030 032  1878 002 732	430 18 MFZ430 430WGTZ	für / for: SA504682-04 950.114/203-204-205	(68)
2531 LS 954.223 2543 LS 954.223 954.233	09.96 - 10.02	OM501LA		3400 122 801   3483 030 032  1878 005 165	430 18 MFZ430 430WGTZ	für / for: SA504682/15 954.223	(68)
	09.96 - 10.02	OM502LA		3400 700 415   3483 030 032  1878 002 732	430 18 MFZ430 430WGTZ	für / for: SA504682-04 954.223	(68)



































		CODE				
--	--	------	--	---	---	---

MERCEDES-BENZ

ACTROS 2527 - 2560		06.96 -					
2532, L, LL 930.224 930.203 930.113 930.206 930.214/215 930.223 930.202 930.204/205 930.114 930.208 930.218 930.225/226 930.213 930.201 2536, L, LL 930.204 930.214 930.201 930.208 930.224 930.114 930.218 930.225/226 930.203 930.215 930.205 930.202 930.206 930.213 930.223 930.113 2541, L, LL 930.225 930.206 930.208 930.114 930.213 930.201 930.224 930.203 930.223 930.113 930.202 930.218 930.226 930.205 930.214/215 930.204 2544, L, LL 930.215 930.202 930.204/205 930.213/214 930.218 930.113 930.208 930.114 930.203 930.201 930.206 2546, L, LL 930.215 930.214 930.213 930.218 930.114 930.203 930.206 930.208 930.226 930.202 930.205 930.225 930.201 930.113 930.223/224 930.204 2548, L, LL 930.114 930.206 930.113 930.214 930.203 930.218 930.205 930.208 930.202 930.204 930.213 930.215 930.201 2551, L, LL 930.201 930.206 930.202 930.205 930.204 930.113/114 930.203 2555, L, LL 930.202 930.201 930.206 930.113/114 930.204 930.203 930.205	04.03-		 3400 122 801 ⊕  3483 030 032  1878 005 165	430 18 MFZ430 430WGTZ	für / for: SA 591014-09 für / for: SA 504682-26 für / for: SA 504682-27	(68) (68) (68)	
				 3400 700 446 ⊕  3483 000 258  1878 005 165	430 18 MFZ430 430WGTZ	für / for: SA 504682-22/24	(68)
		04.03-		 3400 700 415 ⊕  3483 030 032  1878 002 732	430 18 MFZ430 430WGTZ	für / for: SA 504682-28	(68)
				 3400 700 416 ⊕  3483 000 139  1878 005 165	430 18 GMFZ430N 430WGTZ	für Nebenantrieb / for PTO	(82)
		04.03-		 3400 121 501 ⊕  3488 023 031  1878 002 024	400 18 MFZ2/400X 400WGTZ	Nabenprofil / Hub Profile: 45x50-18N für Fahrzeuge mit Zweischeibenkupplung / for vehicles with double disc clutch	(46) (77)
				 3400 700 355 ⊕  3488 000 158  1878 002 019	400 18 MFZ2/400X 400WGTZ	für / for: SA 504682-25 für Fahrzeuge mit Zweischeibenkupplung / for vehicles with double disc clutch	(68) (77)
				 3488 000 102 ⊕	400 GMFZ2/ 400N	für Nebenantrieb / for PTO für Fahrzeuge mit Zweischeibenkupplung / for vehicles with double disc clutch enthält eine Kupplungsscheibe / This part number includes one clutch disc	(82) (77) (66)
		04.03-		 1878 002 024 ▽	400 18 400WGTZ	für Nebenantrieb / for PTO für Fahrzeuge mit Zweischeibenkupplung / for vehicles with double disc clutch Lose Kupplungsscheibe / Loose clutch disc	(82) (77) (39)
		04.03-		 1863 869 028		für / for: SA 505120-01	(68)
			OM501LA	 3400 122 801 ⊕  3483 030 032  1878 005 165	430 18 MFZ430 430WGTZ		
		OM502LA	 3400 700 415 ⊕  3483 030 032  1878 002 732	430 18 MFZ430 430WGTZ			
2532 LS 934.223 934.233 2536 LS 934.223 934.233 2541 LS 934.233 934.223 2544 LS 934.223 934.233 2546 LS 934.223 934.233 2548 LS 934.223 934.233	04.03-	OM541.948, OM541.920, OM541.923, OM541.944, OM541.976, OM541.970, OM541.942, OM541.972, OM541.922, OM541.946, OM541.978, OM541.980, OM541.943, OM541.940, OM541.925	 3400 122 801 ⊕  3483 030 032  1878 005 165	430 18 MFZ430 430WGTZ			
	04.03-		 3400 700 416 ⊕  3483 000 139  1878 005 165	430 18 GMFZ430N 430WGTZ	für Nebenantrieb / for PTO	(82)	
	04.03-		 3400 700 446 ⊕  3483 000 258  1878 005 165	430 18 MFZ430 430WGTZ	für / for: SA 504682 24	(68)	
	04.03-		 3400 121 501 ⊕  3488 023 031  1878 002 024	400 18 MFZ2/400X 400WGTZ	Nabenprofil / Hub Profile: 45x50-18N für Fahrzeuge mit Zweischeibenkupplung / for vehicles with double disc clutch	(46) (77)	
	04.03-		 3400 700 355 ⊕  3488 000 158  1878 002 019	400 18 MFZ2/400X 400WGTZ	für / for: SA 504682-25 für / for: SA 591014-08 für Fahrzeuge mit Zweischeibenkupplung / for vehicles with double disc clutch	(68) (68) (77)	













































		CODE				
--	--	------	--	---	---	---

MERCEDES-BENZ

ACTROS 2527 - 2560		06.96 -					
2533 L 963.021 963.020	07.11 -	OM470	 3400 700 532 	430 18	XTend Nabenprofil / Hub Profile: 45x50-18N Abgasnorm: Euro 6 / Exhaust Emission Norm: Euro 6 max. übertragbares Motormoment [Nm] / max. transmittable engine torque [Nm]: 1900 Nur zusammen verbauen / Only install together	(46) (4) (87)	
2533 LS 963.423	07.11 -						
2533 LS 963.420	07.11 -		 3400 700 530 	430 18	XTend Getr. / GBox: Powershift Nabenprofil / Hub Profile: 45x50-18N Abgasnorm: Euro 6 / Exhaust Emission Norm: Euro 6 max. übertragbares Motormoment [Nm] / max. transmittable engine torque [Nm]: 1900 Nur zusammen verbauen / Only install together	(46) (4) (87)	
2536 L 963.021 963.020	07.11 -						
2536 LS 963.423	07.11 -						
2536 LS 963.420	07.11 -						
2540 L 963.021 963.020	07.11 -		 6482 000 218	PHIS-6/38	Getr. / GBox: Powershift Abgasnorm: Euro 6 / Exhaust Emission Norm: Euro 6 Immer erneuern / Renew everytime	(4) (28)	
2540 LS 963.420	07.11 -						
2543 L 963.021 963.020	07.11 -						
2543 LS 963.420	07.11 -						
2543 LS 963.423	07.11 -						
2535 L 950.208 950.203/204 950.214 950.218 950.224 950.213 950.205 950.223 950.225/226	09.96 - 10.02	OM501LA	 3400 122 701   3483 030 031  1878 005 165	430 18 MFZ430 430WGTZ	950.223-224-225/203-205/213-214		
			 3400 122 801   3483 030 032  1878 005 165	430 18 MFZ430 430WGTZ	für / for: SA504682/15 950.203-204-205/213-214	(68)	
		OM502LA	 3400 700 415   3483 030 032  1878 002 732	430 18 MFZ430 430WGTZ	für / for: SA504682-04 950.203-204-205	(68)	
2535 LS 954.223 954.233	09.96 - 10.02	OM501LA	 3400 122 801   3483 030 032  1878 005 165	430 18 MFZ430 430WGTZ	für / for: SA504682/15 954.223	(68)	
2540 LS 954.223 954.233	09.96 - 10.02	OM502LA	 3400 700 415   3483 030 032  1878 002 732	430 18 MFZ430 430WGTZ	für / for: SA504682-04 954.223/233	(68)	
2540, 2540 L 950.213 950.208 950.203-205 950.114 950.218 950.113 950.214	09.96 - 10.02	OM541.923, OM541.944	 3400 122 801   3483 030 032  1878 005 165	430 18 MFZ430 430WGTZ			
2540 LS 963.423	07.11 -	OM470	 3400 700 532 	430 18	XTend Nabenprofil / Hub Profile: 45x50-18N max. übertragbares Motormoment [Nm] / max. transmittable engine torque [Nm]: 1900 Nur zusammen verbauen / Only install together	(46) (87)	
			 3400 700 530 	430 18	XTend Getr. / GBox: Powershift Nabenprofil / Hub Profile: 45x50-18N max. übertragbares Motormoment [Nm] / max. transmittable engine torque [Nm]: 1900 Nur zusammen verbauen / Only install together	(46) (87)	
			 6482 000 218	PHIS-6/38	Getr. / GBox: Powershift Immer erneuern / Renew everytime	(51) (28)	



















		CODE				
--	--	------	--	---	---	---

MERCEDES-BENZ

ACTROS 2527 - 2560		06.96 -					
2542 L 963.021 963.020 2542 LS 963.423 2542 LS 963.420 2545 L 963.020/021 2545 LS 963.423 2545 LS 963.420 2548 L 963.020/021 2548 LS 963.423 2548 LS 963.420 2551 L 963.021 963.020 2551 LS 963.420 2551 LS 963.423	07.11-	OM471		3400 700 534 	430 18	XTend Nabenprofil / Hub Profile: 45x50-18N Abgasnorm: Euro 6 / Exhaust Emission Norm: Euro 6 max. übertragbares Motormoment [Nm] / max. transmittable engine torque [Nm]: 2600 Nur zusammen verbauen / Only install together	(46) (4) (87) (51)
	07.11-			3400 700 529 	430 18	XTend Getr. / GBox: Powershift Nabenprofil / Hub Profile: 45x50-18N Abgasnorm: Euro 6 / Exhaust Emission Norm: Euro 6 max. übertragbares Motormoment [Nm] / max. transmittable engine torque [Nm]: 2600 Nur zusammen verbauen / Only install together	(46) (4) (87) (51)
	07.11-			6482 000 218	PHIS-6/38	Getr. / GBox: Powershift Abgasnorm: Euro 6 / Exhaust Emission Norm: Euro 6 Immer erneuern / Renew everytime	(4) (28)
	07.11-						
	07.11-						
	07.11-						
	07.11-						
	07.11-						
	07.11-						
	07.11-						
2543, 2543 L 950.205 950.203/204 950.113 950.214 950.208 950.114 950.213	09.96-10.02	OM501LA		3400 122 801   3483 030 032  1878 005 165	430 18 MFZ430 430WGTZ	950.203-205/213-214 Je nach Kundenwunsch mit unterschiedlicher Kupplung / Equipped with different clutch according to customer requirement	(33)
				3400 121 501   3488 023 031  1878 002 024	400 18 MFZ2/400X 400WGTZ	950.203-205/213-214 Nabenprofil / Hub Profile: 45x50-18N Je nach Kundenwunsch mit unterschiedlicher Kupplung / Equipped with different clutch according to customer requirement	(46) (33)
				3400 122 801   3483 030 032  1878 005 165	430 18 MFZ430 430WGTZ	für / for: SA504682/15 950.113-114/203-204-205/213-214	(68)
2548, 2548 L 950.205 950.204 950.114 950.203 950.113 2553, 2553 L 950.114 950.203 950.113 950.204/205	09.96-10.02	OM501LA		3400 122 801   3483 030 032  1878 005 165	430 18 MFZ430 430WGTZ	für / for: SA504682/15 950.113-114/203-204-205	(68)
	09.96-10.02	OM502LA		3400 121 501   3488 023 031  1878 002 024	400 18 MFZ2/400X 400WGTZ	950.203-205 Nabenprofil / Hub Profile: 45x50-18N	(46)
				3400 700 415   3483 030 032  1878 002 732	430 18 MFZ430 430WGTZ	für / for: SA504682-04 950.113-114/203-204-205	(68)
				3488 000 102 	400 GMFZ2/ 400N	für / for: SA504682-08 950.113-114 für Nebenantrieb / for PTO enthält eine Kupplungsscheibe / This part number includes one clutch disc	(68) (82) (66)
				1878 002 024 	400 18 400WGTZ	für / for: SA504682-08 950.113-114 für Nebenantrieb / for PTO Lose Kupplungsscheibe / Loose clutch disc	(68) (82) (39)
2548 LS 954.223 954.233	09.96-10.02	OM501LA		3400 122 801   3483 030 032  1878 005 165	430 18 MFZ430 430WGTZ	für / for: SA504682/15 954.223	(68)
		OM502LA		3400 700 415   3483 030 032  1878 002 732	430 18 MFZ430 430WGTZ	für / for: SA504682-04 954.223	(68)
				3488 000 102 	400 GMFZ2/ 400N	für / for: SA504682-08 954.223 für Nebenantrieb / for PTO enthält eine Kupplungsscheibe / This part number includes one clutch disc	(68) (82) (66)
				1878 002 024 	400 18 400WGTZ	für / for: SA504682-08 954.223 für Nebenantrieb / for PTO Lose Kupplungsscheibe / Loose clutch disc	(68) (82) (39)

















		CODE					
--	--	------	--	--	---	---	---

MERCEDES-BENZ

ACTROS 2527 - 2560		06.96 -					
2553 LS 954.223 954.233	09.96 - 10.02	OM501LA	 3400 122 801 ⊕ ⊗ 3483 030 032 ⊗ 1878 005 165	430 18 MFZ430 430WGTZ	für / for: SA504682/15 954.223	(68)	
		OM502LA	 3400 700 415 ⊕ ⊗ 3483 030 032 ⊗ 1878 002 732	430 18 MFZ430 430WGTZ	für / for: SA504682-04 954.223/233	(68)	
			 3488 000 102 ⊕	400 GMFZ2/ 400N	für / for: SA504682-08 954.223 für Nebenantrieb / for PTO enthält eine Kupplungsscheibe / This part number includes one clutch disc	(68) (82) (66)	
			 1878 002 024 ▽	400 18 400WGTZ	für / for: SA504682-08 954.223 für Nebenantrieb / for PTO Lose Kupplungsscheibe / Loose clutch disc	(68) (82) (39)	
2557 L 950.203	09.96 - 10.02	OM501LA	 3400 122 801 ⊕ ⊗ 3483 030 032 ⊗ 1878 005 165	430 18 MFZ430 430WGTZ	für / for: SA504682/15	(68)	
		OM502LA	 3400 121 501 ⊕ ⊗ 3488 023 031 ⊗ 1878 002 024	400 18 MFZ2/400X 400WGTZ	Nabenprofil / Hub Profile: 45x50-18N	(46)	
2558, L 930.203	04.03 -	OM542.944	 3400 700 468 ⊕ ⊗ 3483 000 422 ⊗ 1878 006 101	430 18 MFZ430 430WGTZ	Motorbauart / Engine Model: V8 Abgasnorm: Euro 4 (D4) / Exhaust Emission Norm: Euro 4 (D4)	(45) (2)	
2560, L, LL 930.201 930.203 930.202 930.205 930.204	04.03 -	OM501LA	 3400 122 801 ⊕ ⊗ 3483 030 032 ⊗ 1878 005 165	430 18 MFZ430 430WGTZ			
		OM502LA	 3400 700 415 ⊕ ⊗ 3483 030 032 ⊗ 1878 002 732	430 18 MFZ430 430WGTZ			
		OM542.964	 3400 122 801 ⊕ ⊗ 3483 030 032 ⊗ 1878 005 165	430 18 MFZ430 430WGTZ	für / for: SA 591014-09 für / for: SA 504682-26 für / for: SA 504682-27	(68) (68) (68)	
			 3400 700 446 ⊕ ⊗ 3483 000 258 ⊗ 1878 005 165	430 18 MFZ430 430WGTZ	für / for: SA 504682-22/24	(68)	
		 3400 700 415 ⊕ ⊗ 3483 030 032 ⊗ 1878 002 732	430 18 MFZ430 430WGTZ	für / for: SA 504682-28	(68)		
		 3400 700 416 ⊕ ⊗ 3483 000 139 ⊗ 1878 005 165	430 18 GMFZ430N 430WGTZ	für Nebenantrieb / for PTO	(82)		
		 3400 121 501 ⊕ ⊗ 3488 023 031 ⊗ 1878 002 024	400 18 MFZ2/400X 400WGTZ	Nabenprofil / Hub Profile: 45x50-18N für Fahrzeuge mit Zweis Scheibenkupplung / for vehicles with double disc clutch	(46) (77)		
		 3400 700 355 ⊕ ⊗ 3488 000 158 ⊗ 1878 002 019	400 18 MFZ2/400X 400WGTZ	für / for: SA 504682-25 für Fahrzeuge mit Zweis Scheibenkupplung / for vehicles with double disc clutch	(68) (77)		
		 3488 000 102 ⊕	400 GMFZ2/ 400N	für Nebenantrieb / for PTO für Fahrzeuge mit Zweis Scheibenkupplung / for vehicles with double disc clutch enthält eine Kupplungsscheibe / This part number includes one clutch disc	(82) (77) (66)		
		 1878 002 024 ▽	400 18 400WGTZ	für Nebenantrieb / for PTO für Fahrzeuge mit Zweis Scheibenkupplung / for vehicles with double disc clutch Lose Kupplungsscheibe / Loose clutch disc	(82) (77) (39)		
		 3400 700 468 ⊕ ⊗ 3483 000 422 ⊗ 1878 006 101	430 18 MFZ430 430WGTZ	Motorbauart / Engine Model: V8 Abgasnorm: Euro 4 (D4) / Exhaust Emission Norm: Euro 4 (D4)	(45) (2)		
		 1863 869 028		für / for: SA 505120-01	(68)		

















		CODE				
--	--	------	--	---	---	---

MERCEDES-BENZ

ACTROS 2627 - 2665		04.96 -						
2627 L 963.025	07.11-	OM936		3400 700 533 	430 18	XTend Nabenprofil / Hub Profile: 45x50-18N Abgasnorm: Euro 6 / Exhaust Emission Norm: Euro 6 max. übertragbares Motormoment [Nm] / max. transmittable engine torque [Nm]: 2100 Nur zusammen verbauen / Only install together	(46) (4) (87) (51)	
2627 L 963.024	07.11-							
2627 LS 963.425	07.11-				3400 700 531 	430 18	XTend Getr. / GBox: Powershift Nabenprofil / Hub Profile: 45x50x-18N Abgasnorm: Euro 6 / Exhaust Emission Norm: Euro 6 max. übertragbares Motormoment [Nm] / max. transmittable engine torque [Nm]: 2100 Nur zusammen verbauen / Only install together	(46) (4) (87) (51)
2627 LS 963.424	07.11-							
2630 L 963.025	07.11-							
2630 L 963.024	07.11-				6482 000 218	PHIS-6/38	Getr. / GBox: Powershift Abgasnorm: Euro 6 / Exhaust Emission Norm: Euro 6 Immer erneuern / Renew everytime	(4) (28)
2630 LS 963.424	07.11-							
2630 LS 963.425	07.11-							
2632 L 963.025	07.11-							
2632 L 963.024	07.11-							
2632 LS 963.425	07.11-							
2632 LS 963.424	07.11-							
2635 L 963.024	07.11-							
2635 L 963.025	07.11-							
2635 LS 963.424	07.11-							
2635 LS 963.425	07.11-							
2631 B 953.141	04.97-10.02	OM501LA		3400 122 701  ⊕ ⊗ 3483 030 031 ⊗ 1878 005 165	430 18 MFZ430 430WGTZ	Je nach Kundenwunsch mit unterschiedlicher Kupplung / Equipped with different clutch according to customer requirement	(33)	
2631, 2631 L 950.142 950.244 950.145 950.242 950.143 950.243	04.96-10.02				3400 121 501  ⊕ ⊗ 3488 023 031 ⊗ 1878 002 024	400 18 MFZ2/400X 400WGTZ	Nabenprofil / Hub Profile: 45x50-18N Je nach Kundenwunsch mit unterschiedlicher Kupplung / Equipped with different clutch according to customer requirement	(46) (33)
					3400 122 801  ⊕ ⊗ 3483 030 032 ⊗ 1878 005 165	430 18 MFZ430 430WGTZ	für / for: SA504682/15 950.242-243-244 951.141	(68)
					3400 700 416  ⊕ ⊗ 3483 000 139 ⊗ 1878 005 165	430 18 GMFZ430N 430WGTZ	für Nebenantrieb / for PTO	(82)
2631 K 952.143 952.142 952.141	04.97-10.02	OM501LA		3400 122 801  ⊕ ⊗ 3483 030 032 ⊗ 1878 005 165	430 18 MFZ430 430WGTZ	für / for: SA504682/15 952.141/143/241	(68)	
2635 K, 2635 LK 952.143 952.241 952.141	04.97-10.02	OM502LA		3400 700 415  ⊕ ⊗ 3483 030 032 ⊗ 1878 002 732	430 18 MFZ430 430WGTZ	für / for: SA504682-04 952.141/143/241	(68)	
2640 K, 2640 LK 952.141 952.143 952.241 952.243	04.97-10.02							
2643 K, 2643 LK 952.141 952.143 952.241 952.243	04.97-10.02							





































		CODE				
--	--	------	--	---	---	---

MERCEDES-BENZ

ACTROS 2627 - 2665		04.96 -					
2632 K, LK 932.141 932.143 932.145 932.241 932.142 2632 LS 934.241 2636 K, LK 932.145 932.142 932.241 932.141 932.143 2636 LS 934.241 2641 K, LK 932.141 932.143 932.145 932.241 932.142 2641 S, LS 934.241 934.141 2644 K, LK 932.142/143 932.141 932.241 932.145 2644 S, LS 934.141 934.241 2646 K, LK 932.241 932.142 932.145 932.141 932.143 2646 S, LS 934.141 934.241	04.03-	OM541.944, OM541.976, OM541.948, OM541.970, OM541.942, OM541.972, OM541.992, OM541.974, OM541.946, OM541.980, OM541.996, OM541.998, OM541.990, OM541.940, OM541.925, OM541.994		3400 122 801 ⊕ 3483 030 032 1878 005 165	430 18 MFZ430 430WGTZ		
	04.03-			3400 700 416 ⊕ 3483 000 139 1878 005 165	430 18 GMFZ430N 430WGTZ	für Nebenantrieb / for PTO	(82)
	04.03-			3400 700 446 ⊕ 3483 000 258 1878 005 165	430 18 MFZ430 430WGTZ	für / for: SA 504682 24	(68)
	04.03-			3400 121 501 ⊕ 3488 023 031 1878 002 024	400 18 MFZ2/400X 400WGTZ	Nabenprofil / Hub Profile: 45x50-18N für Fahrzeuge mit Zweischeibenkupplung / for vehicles with double disc clutch	(46) (77)
	04.03-			3400 700 355 ⊕ 3488 000 158 1878 002 019	400 18 MFZ2/400X 400WGTZ	für / for: SA 504682-25 für / for: SA 591014-08 für Fahrzeuge mit Zweischeibenkupplung / for vehicles with double disc clutch	(68) (68) (77)
	04.03-						
	04.03-						
	04.03-						
	04.03-						
	04.03-						
2632, L, LL 930.142 930.145 930.244 930.242/243 930.143 2636, L, LL 930.244 930.143 930.142 930.242/243 2641, L, LL 930.244 930.143 930.242/243 2644, L, LL 930.142/143 930.242-244 2646, L, LL 930.142 930.244 930.243 930.143 930.145 930.242 2650, L, 2651,L, LL 930.242/243 930.142/143 930.244	04.03-	OM501LA		3400 122 801 ⊕ 3483 030 032 1878 005 165	430 18 MFZ430 430WGTZ		
	04.03-	OM502LA		3400 700 415 ⊕ 3483 030 032 1878 002 732	430 18 MFZ430 430WGTZ		
	04.03-	OM541.944, OM541.976, OM541.948, OM542.940, OM541.970, OM541.942, OM541.972, OM541.992, OM541.974, OM541.946, OM541.980, OM541.996, OM541.998, OM541.990, OM541.940, OM541.994		3400 122 801 ⊕ 3483 030 032 1878 005 165	430 18 MFZ430 430WGTZ	für / for: SA 591014-09 für / for: SA 504682-26 für / for: SA 504682-27	(68) (68) (68)
	04.03-			3400 700 446 ⊕ 3483 000 258 1878 005 165	430 18 MFZ430 430WGTZ	für / for: SA 504682-22/24	(68)
	04.03-			3400 700 415 ⊕ 3483 030 032 1878 002 732	430 18 MFZ430 430WGTZ	für / for: SA 504682-28	(68)
	04.03-			3400 700 416 ⊕ 3483 000 139 1878 005 165	430 18 GMFZ430N 430WGTZ	für Nebenantrieb / for PTO	(82)
	04.03-			3400 121 501 ⊕ 3488 023 031 1878 002 024	400 18 MFZ2/400X 400WGTZ	Nabenprofil / Hub Profile: 45x50-18N für Fahrzeuge mit Zweischeibenkupplung / for vehicles with double disc clutch	(46) (77)
				3400 700 355 ⊕ 3488 000 158 1878 002 019	400 18 MFZ2/400X 400WGTZ	für / for: SA 504682-25 für Fahrzeuge mit Zweischeibenkupplung / for vehicles with double disc clutch	(68) (77)
				3488 000 102 ⊕	400 GMFZ2/ 400N	für Nebenantrieb / for PTO für Fahrzeuge mit Zweischeibenkupplung / for vehicles with double disc clutch enthält eine Kupplungsscheibe / This part number includes one clutch disc	(82) (77) (66)
				1878 002 024 ▽	400 18 400WGTZ	für Nebenantrieb / for PTO für Fahrzeuge mit Zweischeibenkupplung / for vehicles with double disc clutch Lose Kupplungsscheibe / Loose clutch disc	(82) (77) (39)
				1863 869 028		für / for: SA 505120-01	(68)















		CODE				
--	--	------	--	---	---	---

MERCEDES-BENZ

ACTROS 2627 - 2665		04.96 -						
2633 L 963.024 2633 L 963.025 2633 LS 963.424 2633 LS 963.425 2636 L 963.024 2636 L 963.025 2636 LS 963.424 2636 LS 963.425 2640 L 963.024 2640 L 963.025 2640 LS 963.425 2640 LS 963.424 2643 L 963.024 2643 L 963.025 2643 LS 963.424 2643 LS 963.425	07.11-	OM470		3400 700 532 	430 18	XTend Nabenprofil / Hub Profile: 45x50-18N Abgasnorm: Euro 6 / Exhaust Emission Norm: Euro 6 max. übertragbares Motormoment [Nm] / max. transmittable engine torque [Nm]: 1900 Nur zusammen verbauen / Only install together	(46) (4) (87) (51)	
			07.11-		3400 700 530 	430 18	XTend Getr. / GBox: Powershift Nabenprofil / Hub Profile: 45x50-18N Abgasnorm: Euro 6 / Exhaust Emission Norm: Euro 6 max. übertragbares Motormoment [Nm] / max. transmittable engine torque [Nm]: 1900 Nur zusammen verbauen / Only install together	(46) (4) (87) (51)
			07.11-		6482 000 218	PHIS-6/38	Getr. / GBox: Powershift Abgasnorm: Euro 6 / Exhaust Emission Norm: Euro 6 Immer erneuern / Renew everytime	(4) (28)
			07.11-					
			07.11-					
			07.11-					
			07.11-					
			07.11-					
			07.11-					
			07.11-					
			07.11-					
			07.11-					
2635 B 953.141 2635, 2635 L 950.143 950.243 950.142 950.244	04.97-10.02	OM501LA		3400 122 701   3483 030 031  1878 005 165	430 18 MFZ430 430WGTZ	Je nach Kundenwunsch mit unterschiedlicher Kupplung / Equipped with different clutch according to customer requirement	(33)	
	04.96-10.02			3400 121 501   3488 023 031  1878 002 024	400 18 MFZ2/400X 400WGTZ	Nabenprofil / Hub Profile: 45x50-18N Je nach Kundenwunsch mit unterschiedlicher Kupplung / Equipped with different clutch according to customer requirement	(46) (33)	
				3400 122 801   3483 030 032  1878 005 165	430 18 MFZ430 430WGTZ	für / for: SA504682/15	(68)	
				3400 700 416   3483 000 139  1878 005 165	430 18 GMFZ430N 430WGTZ	für Nebenantrieb / for PTO	(82)	
2640 B 953.141 2640, 2640 L 950.242 950.244 950.243 950.143 2643 B 953.141 2643, 2643 L 950.242/243 950.143 950.244	04.97-10.02	OM501LA		3400 122 801   3483 030 032  1878 005 165	430 18 MFZ430 430WGTZ	Je nach Kundenwunsch mit unterschiedlicher Kupplung / Equipped with different clutch according to customer requirement	(33)	
	04.96-10.02			3400 121 501   3488 023 031  1878 002 024	400 18 MFZ2/400X 400WGTZ	Nabenprofil / Hub Profile: 45x50-18N Je nach Kundenwunsch mit unterschiedlicher Kupplung / Equipped with different clutch according to customer requirement	(46) (33)	
	04.97-10.02			3400 122 801   3483 030 032  1878 005 165	430 18 MFZ430 430WGTZ	für / for: SA504682/15	(68)	
	04.96-10.02			3400 700 416   3483 000 139  1878 005 165	430 18 GMFZ430N 430WGTZ	für Nebenantrieb / for PTO	(82)	



















		CODE				
--	--	------	--	---	---	---

MERCEDES-BENZ

ACTROS 2627 - 2665		04.96 -					
2640 S, 2640 LS 954.141 954.241 2643 S, 2643 LS 954.241 954.141	09.96 - 10.02	OM501LA	 3400 122 801 ⊕ ⊗ 3483 030 032 ⊗ 1878 005 165	430 18 MFZ430 430WGTZ	950.143/242-244 953.141 954.141 Je nach Kundenwunsch mit unterschiedlicher Kupplung / Equipped with different clutch according to customer requirement	(33)	
	04.97 - 10.02		 3400 121 501 ⊕ ⊗ 3488 023 031 ⊗ 1878 002 024	400 18 MFZ2/400X 400WGTZ	950.143/242-244 953.141 954.141 Nabenprofil / Hub Profile: 45x50-18N Je nach Kundenwunsch mit unterschiedlicher Kupplung / Equipped with different clutch according to customer requirement	(46) (33)	
			 3400 122 801 ⊕ ⊗ 3483 030 032 ⊗ 1878 005 165	430 18 MFZ430 430WGTZ	für / for: SA504682/15 954.141/241	(68)	
			 3400 700 416 ⊕ ⊗ 3483 000 139 ⊗ 1878 005 165	430 18 GMFZ430N 430WGTZ	950.143/242-244 953.141 954.141 für Nebenantrieb / for PTO	(82)	
		OM502LA	 3400 700 415 ⊕ ⊗ 3483 030 032 ⊗ 1878 002 732	430 18 MFZ430 430WGTZ	für / for: SA504682-04 954.141/241	(68)	
2642 L 963.025 2642 L 963.024 2642 LS 963.425 2642 LS 963.424 2645 L 963.024 2645 L 963.025 2645 LS 963.424 2645 LS 963.425 2648 L 963.024 2648 LS 963.025 2648 L 963.024 2648 LS 963.424 2648 LS 963.425 2651 L 963.025 963.024 2651 L 963.024 2651 LS 963.425 2651 LS 963.424	07.11 -	OM471	 3400 700 534 ⊕ 	430 18	XTend Nabenprofil / Hub Profile: 45x50-18N Abgasnorm: Euro 6 / Exhaust Emission Norm: Euro 6 max. übertragbares Motormoment [Nm] / max. transmittable engine torque [Nm]: 2600 Nur zusammen verbauen / Only install together	(46) (4) (87) (51)	
	07.11 -		 3400 700 529 ⊕ 	430 18	XTend Getr. / GBox: Powershift Nabenprofil / Hub Profile: 45x50-18N Abgasnorm: Euro 6 / Exhaust Emission Norm: Euro 6 max. übertragbares Motormoment [Nm] / max. transmittable engine torque [Nm]: 2600 Nur zusammen verbauen / Only install together	(46) (4) (87) (51)	
	07.11 -		 6482 000 218	PHIS-6/38	Getr. / GBox: Powershift Abgasnorm: Euro 6 / Exhaust Emission Norm: Euro 6 Immer erneuern / Renew everytime	(4) (28)	
	07.11 -						
	07.11 -						
	07.11 -						
	07.11 -						
	07.11 -						
	07.11 -						
	07.11 -						
	07.11 -						
	07.11 -						
2648 K, 2648 LK 952.141 952.143 952.241 952.243 2653 K, 2653 LK 952.241 952.143 952.141 952.243	04.97 - 10.02	OM501LA	 3400 122 801 ⊕ ⊗ 3483 030 032 ⊗ 1878 005 165	430 18 MFZ430 430WGTZ	für / for: SA504682/15 952.141/143/241	(68)	
	04.97 - 10.02	OM502LA	 3400 700 415 ⊕ ⊗ 3483 030 032 ⊗ 1878 002 732	430 18 MFZ430 430WGTZ	für / for: SA504682-04 952.141/143/241	(68)	
			 3488 000 102 ⊕	400 GMFZ2/ 400N	für / for: SA504682-08 952.141/143/241/243 für Nebenantrieb / for PTO enthält eine Kupplungsscheibe / This part number includes one clutch disc	(68) (82) (66)	
			 1878 002 024 ▽	400 18 400WGTZ	für / for: SA504682-08 952.141/143/241/243 für Nebenantrieb / for PTO Lose Kupplungsscheibe / Loose clutch disc	(68) (82) (39)	





















		CODE				
--	--	------	--	---	---	---

MERCEDES-BENZ

ACTROS 2627 - 2665		04.96 -					
2648 LS 934.241	10.02-	OM542.921, OM542.960,	 3400 700 468 ⊕ ⊗ 3483 000 422 ⊗ 1878 006 101	430 18 MFZ430 430WGTZ	Motorbauart / Engine Model: V8 Abgasnorm: Euro 4 (D4) / Exhaust Emission Norm: Euro 4 (D4)	(45)	(2)
2651 LS 934.251	10.09-	OM542.920, OM542.942, OM542.962, OM542.964					
2653 LS 934.251	10.09-						
2655 LS 934.251	10.09-						
2660 L, LL 930.242/243	05.05-						
2660 S, LS 934.241	06.08-						
2648 S, 2648 LS 954.241 954.141	09.96-10.02	OM501LA	 3400 122 801 ⊕ ⊗ 3483 030 032 ⊗ 1878 005 165	430 18 MFZ430 430WGTZ	für / for: SA504682/15 954.141/241	(68)	
		OM502LA	 3400 121 501 ⊕ ⊗ 3488 023 031 ⊗ 1878 002 024	400 18 MFZ2/400X 400WGTZ	950.143/242-244 954.141 Nabenprofil / Hub Profile: 45x50-18N	(46)	
			 3400 700 416 ⊕ ⊗ 3483 000 139 ⊗ 1878 005 165	430 18 GMFZ430N 430WGTZ	950.143/242-244 954.141 für Nebenantrieb / for PTO	(82)	
			 3400 700 415 ⊕ ⊗ 3483 030 032 ⊗ 1878 002 732	430 18 MFZ430 430WGTZ	für / for: SA504682-04 954.141/241	(68)	
			 3488 000 102 ⊕	400 GMFZ2/ 400N	für / for: SA504682-08 954.141/241 für Nebenantrieb / for PTO enthält eine Kupplungsscheibe / This part number includes one clutch disc	(68)	(82) (66)
			 1878 002 024 ▽	400 18 400WGTZ	für / for: SA504682-08 954.141/241 für Nebenantrieb / for PTO Lose Kupplungsscheibe / Loose clutch disc	(68)	(82) (39)
2648, 2648 L 950.143 950.244 950.243 950.242	04.96-10.02	OM501LA	 3400 122 801 ⊕ ⊗ 3483 030 032 ⊗ 1878 005 165	430 18 MFZ430 430WGTZ	für / for: SA504682/15 950.143/242-243-244	(68)	
		OM502LA	 3400 121 501 ⊕ ⊗ 3488 023 031 ⊗ 1878 002 024	400 18 MFZ2/400X 400WGTZ	950.143/242-244 954.141 Nabenprofil / Hub Profile: 45x50-18N	(46)	
			 3400 700 416 ⊕ ⊗ 3483 000 139 ⊗ 1878 005 165	430 18 GMFZ430N 430WGTZ	950.143/242-244 954.141 für Nebenantrieb / for PTO	(82)	
			 3400 700 415 ⊕ ⊗ 3483 030 032 ⊗ 1878 002 732	430 18 MFZ430 430WGTZ	für / for: SA504682-04 950.143/242-243-244	(68)	
			 3488 000 102 ⊕	400 GMFZ2/ 400N	für / for: SA504682-08 950.143 für Nebenantrieb / for PTO enthält eine Kupplungsscheibe / This part number includes one clutch disc	(68)	(82) (66)
			 1878 002 024 ▽	400 18 400WGTZ	für / for: SA504682-08 950.143 für Nebenantrieb / for PTO Lose Kupplungsscheibe / Loose clutch disc	(68)	(82) (39)
2650 K, 2651 K, LK 932.141 932.145 932.143 932.241	04.03-	OM542.940, OM542.960, OM542.920,	 3400 700 415 ⊕ ⊗ 3483 030 032 ⊗ 1878 002 732	430 18 MFZ430 430WGTZ			
2650 S, LS 934.223 934.241 934.141 934.233	04.03-	OM542.944, OM542.942, OM542.962	 3488 000 102 ⊕	400 GMFZ2/ 400N	für Nebenantrieb / for PTO enthält eine Kupplungsscheibe / This part number includes one clutch disc	(82)	(66)
2654 K, LK, 2655 K, LK 932.141 932.145 932.241 932.143	04.03-		 1878 002 024 ▽	400 18 400WGTZ	für Nebenantrieb / for PTO Lose Kupplungsscheibe / Loose clutch disc	(82)	(39)
2654 S, LS 934.233 934.223 934.241 934.141	04.03-		 3400 121 501 ⊕ ⊗ 3488 023 031 ⊗ 1878 002 024	400 18 MFZ2/400X 400WGTZ	Nabenprofil / Hub Profile: 45x50-18N für Fahrzeuge mit Zweischeibenkupplung / for vehicles with double disc clutch	(46)	(77)
2658 K, LK 932.241 932.141	04.03-		 3400 700 355 ⊕ ⊗ 3488 000 158 ⊗ 1878 002 019	400 18 MFZ2/400X 400WGTZ	für / for: SA 591014-08 für / for: SA 504682-25 für Fahrzeuge mit Zweischeibenkupplung / for vehicles with double disc clutch	(68)	(68) (77)
2653 950.143 954.141 950.243	01.96-	OM442LA	 3400 121 601 ⊗ 3488 017 432 ⊗ 1878 634 022 ⊗ 3151 000 547	400 10 MFZ2/400X 400GVZ KZISZ-5			

		CODE				
--	--	------	--	---	---	---











MERCEDES-BENZ

ACTROS 2627 - 2665		04.96 -						
2653, 2653 L 950.143 950.243 2653 S, 2653 LS 954.141 954.241	04.96 - 10.02	OM501LA	 3400 122 801 ⊕ ⊗ 3483 030 032 ⊗ 1878 005 165	430 18 MFZ430 430WGTZ	für / for: SA504682/15 950.143/243 954.141/241	(68)		
	09.96 - 10.02	OM502LA	 3400 121 501 ⊕ ⊗ 3488 023 031 ⊗ 1878 002 024	400 18 MFZ2/400X 400WGTZ	950.143/243 954.141 Nabenprofil / Hub Profile: 45x50-18N	(46)		
			 3400 700 416 ⊕ ⊗ 3483 000 139 ⊗ 1878 005 165	430 18 GMFZ430N 430WGTZ	950.143/243 954.141 für Nebenantrieb / for PTO	(82)		
			 3400 700 415 ⊕ ⊗ 3483 030 032 ⊗ 1878 002 732	430 18 MFZ430 430WGTZ	für / for: SA504682-04 950.143/243 954.141/241	(68)		
			 3488 000 102 ⊕	400 GMFZ2/ 400N	für / for: SA504682-08 950.143/243 954.141/241 für Nebenantrieb / for PTO enthält eine Kupplungsscheibe / This part number includes one clutch disc	(68) (82) (66)		
			 1878 002 024 ▽	400 18 400WGTZ	für / for: SA504682-08 950.143/243 954.141/241 für Nebenantrieb / for PTO Lose Kupplungsscheibe / Loose clutch disc	(68) (82) (39)		
2654, L, 2655, L, LL 930.243 930.242 930.244 930.142/143 2658 L 930.242/243	04.03 -	OM501LA	 3400 122 801 ⊕ ⊗ 3483 030 032 ⊗ 1878 005 165	430 18 MFZ430 430WGTZ				
	04.03 -	OM502LA	 3400 700 415 ⊕ ⊗ 3483 030 032 ⊗ 1878 002 732	430 18 MFZ430 430WGTZ				
		OM542.944, OM542.942, OM542.962	 3400 122 801 ⊕ ⊗ 3483 030 032 ⊗ 1878 005 165	430 18 MFZ430 430WGTZ	für / for: SA 591014-09 für / for: SA 504682-26 für / for: SA 504682-27	(68) (68) (68)		
			 3400 700 446 ⊕ ⊗ 3483 000 258 ⊗ 1878 005 165	430 18 MFZ430 430WGTZ	für / for: SA 504682-22/24	(68)		
		 3400 700 415 ⊕ ⊗ 3483 030 032 ⊗ 1878 002 732	430 18 MFZ430 430WGTZ	für / for: SA 504682-28	(68)			
		 3400 700 416 ⊕ ⊗ 3483 000 139 ⊗ 1878 005 165	430 18 GMFZ430N 430WGTZ	für Nebenantrieb / for PTO	(82)			
		 3400 121 501 ⊕ ⊗ 3488 023 031 ⊗ 1878 002 024	400 18 MFZ2/400X 400WGTZ	Nabenprofil / Hub Profile: 45x50-18N für Fahrzeuge mit Zweischeibenkupplung / for vehicles with double disc clutch	(46) (77)			
		 3400 700 355 ⊕ ⊗ 3488 000 158 ⊗ 1878 002 019	400 18 MFZ2/400X 400WGTZ	für / for: SA 504682-25 für Fahrzeuge mit Zweischeibenkupplung / for vehicles with double disc clutch	(68) (77)			
		 3488 000 102 ⊕	400 GMFZ2/ 400N	für Nebenantrieb / for PTO für Fahrzeuge mit Zweischeibenkupplung / for vehicles with double disc clutch enthält eine Kupplungsscheibe / This part number includes one clutch disc	(82) (77) (66)			
		 1878 002 024 ▽	400 18 400WGTZ	für Nebenantrieb / for PTO für Fahrzeuge mit Zweischeibenkupplung / for vehicles with double disc clutch Lose Kupplungsscheibe / Loose clutch disc	(82) (77) (39)			
		 3400 700 468 ⊕ ⊗ 3483 000 422 ⊗ 1878 006 101	430 18 MFZ430 430WGTZ	Motorbauart / Engine Model: V8 Abgasnorm: Euro 4 (D4) / Exhaust Emission Norm: Euro 4 (D4)	(45) (2)			
		 1863 869 028		für / for: SA 505120-01	(68)			
		2657 K, 2657 LK 952.141 952.241 952.243	04.97 - 10.02	OM501LA	 3400 122 801 ⊕ ⊗ 3483 030 032 ⊗ 1878 005 165	430 18 MFZ430 430WGTZ	für / for: SA504682/15 952.141/241	(68)
				OM502LA	 3488 000 102 ⊕	400 GMFZ2/ 400N	für / for: SA504682-08 952.141/241/243 für Nebenantrieb / for PTO enthält eine Kupplungsscheibe / This part number includes one clutch disc	(68) (82) (66)
 1878 002 024 ▽	400 18 400WGTZ				für / for: SA504682-08 952.141/241/243 für Nebenantrieb / for PTO Lose Kupplungsscheibe / Loose clutch disc	(68) (82) (39)		





		CODE					
--	--	------	--	--	---	---	---

MERCEDES-BENZ

ACTROS 2627 - 2665 04.96 -





















2657 L 950.243	04.97 - 10.02	OM501LA	 3400 122 801 ⊕ ⊗ 3483 030 032 ⊗ 1878 005 165	430 18 MFZ430 430WGTZ	für / for: SA504682/15 950.243	(68)
		OM502LA	 3400 121 501 ⊕ ⊗ 3488 023 031 ⊗ 1878 002 024	400 18 MFZ2/400X 400WGTZ	950.243 Nabenprofil / Hub Profile: 45x50-18N	(46)
2657 S, 2657 LS 954.241	04.97 - 10.02	OM501LA	 3400 122 801 ⊕ ⊗ 3483 030 032 ⊗ 1878 005 165	430 18 MFZ430 430WGTZ	für / for: SA504682/15 954.241	(68)
		OM502LA	 3488 000 102 ⊕	400 GMFZ2/ 400N	für / for: SA504682-08 954.241 für Nebenantrieb / for PTO enthält eine Kupplungsscheibe / This part number includes one clutch disc	(68) (82) (66)
			 1878 002 024 ▽	400 18 400WGTZ	für / for: SA504682-08 954.241 für Nebenantrieb / for PTO Lose Kupplungsscheibe / Loose clutch disc	(68) (82) (39)
2658 LS 934.241	04.03 -	OM542.944	 3400 700 415 ⊕ ⊗ 3483 030 032 ⊗ 1878 002 732	430 18 MFZ430 430WGTZ		
			 3488 000 102 ⊕	400 GMFZ2/ 400N	für Nebenantrieb / for PTO enthält eine Kupplungsscheibe / This part number includes one clutch disc	(82) (66)
			 1878 002 024 ▽	400 18 400WGTZ	für Nebenantrieb / for PTO Lose Kupplungsscheibe / Loose clutch disc	(82) (39)
			 3400 121 501 ⊕ ⊗ 3488 023 031 ⊗ 1878 002 024	400 18 MFZ2/400X 400WGTZ	Nabenprofil / Hub Profile: 45x50-18N für Fahrzeuge mit Zweischeibenkupplung / for vehicles with double disc clutch	(46) (77)
			 3400 700 355 ⊕ ⊗ 3488 000 158 ⊗ 1878 002 019	400 18 MFZ2/400X 400WGTZ	für / for: SA 504682-25 für / for: SA 591014-08 für Fahrzeuge mit Zweischeibenkupplung / for vehicles with double disc clutch	(68) (68) (77)
			 3400 700 468 ⊕ ⊗ 3483 000 422 ⊗ 1878 006 101	430 18 MFZ430 430WGTZ	Motorbauart / Engine Model: V8 Abgasnorm: Euro 4 (D4) / Exhaust Emission Norm: Euro 4 (D4)	(45) (2)

ACTROS 3231 - 3339 06.96 -

3231 B 953.304 3235 B 953.304/305	04.97 - 10.02	OM501LA	 3400 122 701 ⊕ ⊗ 3483 030 031 ⊗ 1878 005 165	430 18 MFZ430 430WGTZ	Je nach Kundenwunsch mit unterschiedlicher Kupplung / Equipped with different clutch according to customer requirement	(33)
	04.97 - 10.02		 3400 121 501 ⊕ ⊗ 3488 023 031 ⊗ 1878 002 024	400 18 MFZ2/400X 400WGTZ	Nabenprofil / Hub Profile: 45x50-18N Je nach Kundenwunsch mit unterschiedlicher Kupplung / Equipped with different clutch according to customer requirement	(46) (33)
			 3400 700 416 ⊕ ⊗ 3483 000 139 ⊗ 1878 005 165	430 18 GMFZ430N 430WGTZ	für Nebenantrieb / for PTO	(82)
			 3400 122 801 ⊕ ⊗ 3483 030 032 ⊗ 1878 005 165	430 18 MFZ430 430WGTZ	für / for: SA504682/15	(68)
3231 K 952.304	04.97 - 10.02	OM501LA	 3400 122 801 ⊕ ⊗ 3483 030 032 ⊗ 1878 005 165	430 18 MFZ430 430WGTZ	für / for: SA504682/15 950.306 952.304	(68)
3235 K 952.305 952.304 952.307	04.97 - 10.02					
3240 950.306 953.305	04.97 - 10.02					
3240 K 952.304/305	04.97 - 10.02					
3243 950.306 953.305	04.97 - 10.02					
3243 K 952.304/305	04.97 - 10.02					



















		CODE				
--	--	------	--	---	---	---

MERCEDES-BENZ

ACTROS 3231 - 3339		06.96 -						
3231 K, 3232 K 932.304 932.307 932.305 3331 AK, 3332 AK 932.183 932.182 3331 S, 3332 S 934.161 3332 K 932.161-163 3336 K 932.304/305 932.307 3336 S 934.161	04.03-	OM541.920, OM541.970, OM541.942, OM541.972, OM541.996, OM541.940, OM541.926		3400 122 801 ⊕ ● 3483 030 032 ● 1878 005 165	430 18 MFZ430 430WGTZ			
	04.03-			3400 700 416 ⊕ ● 3483 000 139 ● 1878 005 165	430 18 GMFZ430N 430WGTZ	für Nebenantrieb / for PTO	(82)	
	04.03-			3400 700 446 ⊕ ● 3483 000 258 ● 1878 005 165	430 18 MFZ430 430WGTZ	für / for: SA 504682 24	(68)	
	04.03-			3400 121 501 ⊕ ● 3488 023 031 ● 1878 002 024	400 18 MFZ2/400X 400WGTZ	Nabenprofil / Hub Profile: 45x50-18N für Fahrzeuge mit Zweischeibenkupplung / for vehicles with double disc clutch	(46) (77)	
	04.03-			3400 700 355 ⊕ ● 3488 000 158 ● 1878 002 019	400 18 MFZ2/400X 400WGTZ	für / for: SA 504682-25 für / for: SA 591014-08 für Fahrzeuge mit Zweischeibenkupplung / for vehicles with double disc clutch	(68) (68) (77)	
	04.03-							
3240 B 953.304/305 3243 B 953.305 953.304	04.97 - 10.02	OM501LA		3400 122 801 ⊕ ● 3483 030 032 ● 1878 005 165	430 18 MFZ430 430WGTZ	Je nach Kundenwunsch mit unterschiedlicher Kupplung / Equipped with different clutch according to customer requirement	(33)	
	04.97 - 10.02			3400 121 501 ⊕ ● 3488 023 031 ● 1878 002 024	400 18 MFZ2/400X 400WGTZ	Nabenprofil / Hub Profile: 45x50-18N Je nach Kundenwunsch mit unterschiedlicher Kupplung / Equipped with different clutch according to customer requirement	(46) (33)	
				3400 700 416 ⊕ ● 3483 000 139 ● 1878 005 165	430 18 GMFZ430N 430WGTZ	für Nebenantrieb / for PTO	(82)	
				3400 122 801 ⊕ ● 3483 030 032 ● 1878 005 165	430 18 MFZ430 430WGTZ	für / for: SA504682/15	(68)	
3241 930.306 3244 930.306 3246 930.306 3248, L 930.306 3331, 3332 930.162/163 3336 930.162/163	04.03-	OM501LA		3400 122 801 ⊕ ● 3483 030 032 ● 1878 005 165	430 18 MFZ430 430WGTZ			
	04.03-	OM502LA		3400 700 415 ⊕ ● 3483 030 032 ● 1878 002 732	430 18 MFZ430 430WGTZ			
	04.03-	OM541.920, OM541.976, OM541.948, OM541.944, OM541.942, OM541.972, OM541.992, OM541.974, OM541.978, OM541.980, OM541.990, OM541.940		3400 122 801 ⊕ ● 3483 030 032 ● 1878 005 165	430 18 MFZ430 430WGTZ	für / for: SA 591014-09 für / for: SA 504682-26 für / for: SA 504682-27	(68) (68) (68)	
	04.03-		3400 700 446 ⊕ ● 3483 000 258 ● 1878 005 165	430 18 MFZ430 430WGTZ	für / for: SA 504682-22/24	(68)		
	04.03-		3400 700 415 ⊕ ● 3483 030 032 ● 1878 002 732	430 18 MFZ430 430WGTZ	für / for: SA 504682-28	(68)		
			3400 700 416 ⊕ ● 3483 000 139 ● 1878 005 165	430 18 GMFZ430N 430WGTZ	für Nebenantrieb / for PTO	(82)		
			3400 121 501 ⊕ ● 3488 023 031 ● 1878 002 024	400 18 MFZ2/400X 400WGTZ	Nabenprofil / Hub Profile: 45x50-18N für Fahrzeuge mit Zweischeibenkupplung / for vehicles with double disc clutch	(46) (77)		
			3400 700 355 ⊕ ● 3488 000 158 ● 1878 002 019	400 18 MFZ2/400X 400WGTZ	für / for: SA 504682-25 für Fahrzeuge mit Zweischeibenkupplung / for vehicles with double disc clutch	(68) (77)		
			3488 000 102 ⊕	400 GMFZ2/ 400N	für Nebenantrieb / for PTO für Fahrzeuge mit Zweischeibenkupplung / for vehicles with double disc clutch enthält eine Kupplungsscheibe / This part number includes one clutch disc	(82) (77) (66)		
			1878 002 024 ▽	400 18 400WGTZ	für Nebenantrieb / for PTO für Fahrzeuge mit Zweischeibenkupplung / for vehicles with double disc clutch Lose Kupplungsscheibe / Loose clutch disc	(82) (77) (39)		
			1863 869 028		für / for: SA 505120-01	(68)		
	3260 L 930.162	02.09-	OM542.964		3400 700 468 ⊕ ● 3483 000 422 ● 1878 006 101	430 18 MFZ430 430WGTZ	Motorbauart / Engine Model: V8 Abgasnorm: Euro 4 (D4) / Exhaust Emission Norm: Euro 4 (D4)	(45) (2)



		CODE				
--	--	------	--	---	---	---













MERCEDES-BENZ

ACTROS 3231 - 3339		06.96 -					
3331 950.162/163 3331 A 950.183 950.182 3331 B 953.163 953.162 953.161 3331 S 954.161	04.97 - 10.02	OM501LA		3400 122 701 ⊕ 3483 030 031 1878 005 165	430 18 MFZ430 430WGTZ	950.163/183 953.161-163 954.161 Je nach Kundenwunsch mit unterschiedlicher Kupplung / Equipped with different clutch according to customer requirement	(33)
	04.97 - 10.02			3400 121 501 ⊕ 3488 023 031 1878 002 024	400 18 MFZ2/400X 400WGTZ	950.163/183 953.161-163 954.161 Nabenprofil / Hub Profile: 45x50-18N Je nach Kundenwunsch mit unterschiedlicher Kupplung / Equipped with different clutch according to customer requirement	(46) (33)
	04.97 - 10.02			3400 700 416 ⊕ 3483 000 139 1878 005 165	430 18 GMFZ430N 430WGTZ	950.163/183 953.161-163 954.161 für Nebenantrieb / for PTO	(82)
	04.97 - 10.02			3400 122 801 ⊕ 3483 030 032 1878 005 165	430 18 MFZ430 430WGTZ	für / for: SA504682/15 950.162-163 954.161	(68)
3331 A, 3332 A 930.182/183 3336 A 930.183 930.182	04.03 -	OM541.920, OM541.942, OM541.999, OM541.941, OM541.997, OM541.973, OM541.943, OM541.926, OM541.940, OM541.971		3400 122 801 ⊕ 3483 030 032 1878 005 165	430 18 MFZ430 430WGTZ	für / for: SA 591014-09 für / for: SA 504682-26 für / for: SA 504682-27	(68) (68) (68)
	04.03 -			3400 700 446 ⊕ 3483 000 258 1878 005 165	430 18 MFZ430 430WGTZ	für / for: SA 504682-22/24	(68)
				3400 700 415 ⊕ 3483 030 032 1878 002 732	430 18 MFZ430 430WGTZ	für / for: SA 504682-28	(68)
				3400 700 416 ⊕ 3483 000 139 1878 005 165	430 18 GMFZ430N 430WGTZ	für Nebenantrieb / for PTO	(82)
				3400 121 501 ⊕ 3488 023 031 1878 002 024	400 18 MFZ2/400X 400WGTZ	Nabenprofil / Hub Profile: 45x50-18N für Fahrzeuge mit Zweischeibenkupplung / for vehicles with double disc clutch	(46) (77)
				3400 700 355 ⊕ 3488 000 158 1878 002 019	400 18 MFZ2/400X 400WGTZ	für / for: SA 504682-25 für Fahrzeuge mit Zweischeibenkupplung / for vehicles with double disc clutch	(68) (77)
				3488 000 102 ⊕	400 GMFZ2/ 400N	für Nebenantrieb / for PTO für Fahrzeuge mit Zweischeibenkupplung / for vehicles with double disc clutch enthält eine Kupplungsscheibe / This part number includes one clutch disc	(82) (77) (66)
				1878 002 024 ▽	400 18 400WGTZ	für Nebenantrieb / for PTO für Fahrzeuge mit Zweischeibenkupplung / for vehicles with double disc clutch Lose Kupplungsscheibe / Loose clutch disc	(82) (77) (39)
3331 AK 952.183 952.182 3331 AS 954.182 3335 950.162 3335 S 954.161	04.97 - 10.02	OM501LA		3400 122 801 ⊕ 3483 030 032 1878 005 165	430 18 MFZ430 430WGTZ	für / for: SA504682-15	(68)
	04.97 - 10.02	OM502LA		3400 700 415 ⊕ 3483 030 032 1878 002 732	430 18 MFZ430 430WGTZ	für / for: SA504682-04	(68)
	04.97 - 10.02						
3331 K 952.161-163 3335 K 952.162/163 952.161	04.97 - 10.02	OM501LA		3400 122 801 ⊕ 3483 030 032 1878 005 165	430 18 MFZ430 430WGTZ	für / for: SA504682/15 952.161/163	(68)
	04.97 - 10.02	OM502LA		3400 700 415 ⊕ 3483 030 032 1878 002 732	430 18 MFZ430 430WGTZ	für / for: SA504682-04 952.161/163	(68)
3333 L 963.026 3333 LS 963.426 3336 L 963.026 3336 LS 963.426	07.11 -	OM470		3400 700 532 ⊕	430 18	XTend Nabenprofil / Hub Profile: 45x50-18N Abgasnorm: Euro 6 / Exhaust Emission Norm: Euro 6 max. übertragbares Motormoment [Nm] / max. transmittable engine torque [Nm]: 1900 Nur zusammen verbauen / Only install together	(46) (4) (87)
	07.11 -			3400 700 530 ⊕	430 18	XTend Getr. / GBox: Powershift Nabenprofil / Hub Profile: 45x50-18N Abgasnorm: Euro 6 / Exhaust Emission Norm: Euro 6 max. übertragbares Motormoment [Nm] / max. transmittable engine torque [Nm]: 1900 Nur zusammen verbauen / Only install together	(46) (4) (87)
	07.11 -			6482 000 218	PHIS-6/38	Getr. / GBox: Powershift Abgasnorm: Euro 6 / Exhaust Emission Norm: Euro 6	(4)

		CODE				
--	--	------	--	---	---	---



















MERCEDES-BENZ

ACTROS 3231 - 3339		06.96 -				
3335 B 953.161-163	04.97 - 10.02	OM501LA	 3400 122 701 ⊕ ⊗ 3483 030 031 ⊗ 1878 005 165	430 18 MFZ430 430WGTZ	Je nach Kundenwunsch mit unterschiedlicher Kupplung / Equipped with different clutch according to customer requirement	(33)
			 3400 121 501 ⊕ ⊗ 3488 023 031 ⊗ 1878 002 024	400 18 MFZ2/400X 400WGTZ	Nabenprofil / Hub Profile: 45x50-18N Je nach Kundenwunsch mit unterschiedlicher Kupplung / Equipped with different clutch according to customer requirement	(46) (33)
			 3400 700 416 ⊕ ⊗ 3483 000 139 ⊗ 1878 005 165	430 18 GMFZ430N 430WGTZ	für Nebenantrieb / for PTO	(82)

ACTROS 3340 - 3550		06.96 -				
3340 950.163	04.97 - 10.02	OM501LA	 3400 122 801 ⊕ ⊗ 3483 030 032 ⊗ 1878 005 165	430 18 MFZ430 430WGTZ	950.163/183 953.161-163 954.161 Je nach Kundenwunsch mit unterschiedlicher Kupplung / Equipped with different clutch according to customer requirement	(33)
			 3400 121 501 ⊕ ⊗ 3488 023 031 ⊗ 1878 002 024	400 18 MFZ2/400X 400WGTZ	950.163/183 953.161-163 954.161 Nabenprofil / Hub Profile: 45x50-18N Je nach Kundenwunsch mit unterschiedlicher Kupplung / Equipped with different clutch according to customer requirement	(46) (33)
			 3400 700 416 ⊕ ⊗ 3483 000 139 ⊗ 1878 005 165	430 18 GMFZ430N 430WGTZ	950.163/183 953.161-163 954.161 für Nebenantrieb / for PTO	(82)
			 3400 122 801 ⊕ ⊗ 3483 030 032 ⊗ 1878 005 165	430 18 MFZ430 430WGTZ	für / for: SA504682/15 950.163	(68)
		OM502LA	 3400 700 415 ⊕ ⊗ 3483 030 032 ⊗ 1878 002 732	430 18 MFZ430 430WGTZ	für / for: SA504682-04 950.163	(68)
3340 L 963.026 3340 LS 963.426 3343 L 963.026 3343 LS 963.426	07.11 -	OM470	 3400 700 532 	430 18	XTend Nabenprofil / Hub Profile: 45x50-18N Abgasnorm: Euro 6 / Exhaust Emission Norm: Euro 6 max. übertragbares Motormoment [Nm] / max. transmittable engine torque [Nm]: 1900 Nur zusammen verbauen / Only install together	(46) (4) (87)
	07.11 -		 3400 700 530 	430 18	XTend Getr. / GBox: Powershift Nabenprofil / Hub Profile: 45x50-18N Abgasnorm: Euro 6 / Exhaust Emission Norm: Euro 6 max. übertragbares Motormoment [Nm] / max. transmittable engine torque [Nm]: 1900 Nur zusammen verbauen / Only install together	(46) (4) (87) (51)
	07.11 -		 6482 000 218	PHIS-6/38	Getr. / GBox: Powershift Abgasnorm: Euro 6 / Exhaust Emission Norm: Euro 6 Immer erneuern / Renew everytime	(4) (28)
3340 A 950.182/183 3340 B 953.161-163	04.97 - 10.02	OM501LA	 3400 122 801 ⊕ ⊗ 3483 030 032 ⊗ 1878 005 165	430 18 MFZ430 430WGTZ	950.163/183 953.161-163 954.161 Je nach Kundenwunsch mit unterschiedlicher Kupplung / Equipped with different clutch according to customer requirement	(33)
	04.97 - 10.02		 3400 121 501 ⊕ ⊗ 3488 023 031 ⊗ 1878 002 024	400 18 MFZ2/400X 400WGTZ	950.163/183 953.161-163 954.161 Nabenprofil / Hub Profile: 45x50-18N Je nach Kundenwunsch mit unterschiedlicher Kupplung / Equipped with different clutch according to customer requirement	(46) (33)
			 3400 700 416 ⊕ ⊗ 3483 000 139 ⊗ 1878 005 165	430 18 GMFZ430N 430WGTZ	950.163/183 953.161-163 954.161 für Nebenantrieb / for PTO	(82)





















































		CODE				
--	--	------	--	---	---	---

MERCEDES-BENZ

ACTROS 3340 - 3550		06.96 -								
3340 AK 952.182/183	04.97 - 10.02	OM501LA	 3400 122 801 ⊕ ⊗ 3483 030 032 ⊗ 1878 005 165	430 18 MFZ430 430WGTZ	für / for: SA504682-15		(68)			
3340 AS 954.182	04.97 - 10.02	OM502LA	 3400 700 415 ⊕ ⊗ 3483 030 032 ⊗ 1878 002 732	430 18 MFZ430 430WGTZ	für / for: SA504682-04		(68)			
3340 K 952.162/163 952.161	04.97 - 10.02									
3343 AK 952.183 952.182	04.97 - 10.02									
3343 AS 954.182	04.97 - 10.02									
3343 K 952.161 952.163	04.97 - 10.02									
3340 S 954.161	04.97 - 10.02	OM501LA	 3400 122 801 ⊕ ⊗ 3483 030 032 ⊗ 1878 005 165	430 18 MFZ430 430WGTZ	Je nach Kundenwunsch mit unterschiedlicher Kupplung / Equipped with different clutch according to customer requirement		(33)			
3343 950.163 950.162	04.97 - 10.02	OM502LA	 3400 121 501 ⊕ ⊗ 3488 023 031 ⊗ 1878 002 024	400 18 MFZ2/400X 400WGTZ	Nabenprofil / Hub Profile: 45x50-18N Je nach Kundenwunsch mit unterschiedlicher Kupplung / Equipped with different clutch according to customer requirement		(46) (33)			
3343 S 954.161	04.97 - 10.02				 3400 700 416 ⊕ ⊗ 3483 000 139 ⊗ 1878 005 165	430 18 GMFZ430N 430WGTZ	für Nebenantrieb / for PTO		(82)	
					 3400 122 801 ⊕ ⊗ 3483 030 032 ⊗ 1878 005 165	430 18 MFZ430 430WGTZ	für / for: SA504682/15		(68)	
					 3400 700 415 ⊕ ⊗ 3483 030 032 ⊗ 1878 002 732	430 18 MFZ430 430WGTZ	für / for: SA504682-04		(68)	
3341 930.162/163	04.03 -	OM501LA	 3400 122 801 ⊕ ⊗ 3483 030 032 ⊗ 1878 005 165	430 18 MFZ430 430WGTZ						
3344 930.163 930.162	04.03 -	OM502LA	 3400 700 415 ⊕ ⊗ 3483 030 032 ⊗ 1878 002 732	430 18 MFZ430 430WGTZ						
3346 930.163 930.162	04.03 -	OM541.944, OM541.947, OM541.948, OM541.974, OM541.946	 3400 122 801 ⊕ ⊗ 3483 030 032 ⊗ 1878 005 165	430 18 MFZ430 430WGTZ	für / for: SA 591014-09		(68)			
3360 930.162	04.03 -				 3400 700 446 ⊕ ⊗ 3483 000 258 ⊗ 1878 005 165	430 18 MFZ430 430WGTZ	für / for: SA 504682-22/24		(68)	
					 3400 700 415 ⊕ ⊗ 3483 030 032 ⊗ 1878 002 732	430 18 MFZ430 430WGTZ	für / for: SA 504682-28		(68)	
					 3400 700 416 ⊕ ⊗ 3483 000 139 ⊗ 1878 005 165	430 18 GMFZ430N 430WGTZ	für Nebenantrieb / for PTO		(82)	
					 3400 121 501 ⊕ ⊗ 3488 023 031 ⊗ 1878 002 024	400 18 MFZ2/400X 400WGTZ	Nabenprofil / Hub Profile: 45x50-18N für Fahrzeuge mit Zweischeibenkupplung / for vehicles with double disc clutch		(46) (77)	
					 3400 700 355 ⊕ ⊗ 3488 000 158 ⊗ 1878 002 019	400 18 MFZ2/400X 400WGTZ	für / for: SA 504682-25 für Fahrzeuge mit Zweischeibenkupplung / for vehicles with double disc clutch		(68) (77)	
					 3488 000 102 ⊕	400 GMFZ2/ 400N	für Nebenantrieb / for PTO für Fahrzeuge mit Zweischeibenkupplung / for vehicles with double disc clutch enthält eine Kupplungsscheibe / This part number includes one clutch disc		(82) (77) (66)	
					 1878 002 024 ▽	400 18 400WGTZ	für Nebenantrieb / for PTO für Fahrzeuge mit Zweischeibenkupplung / for vehicles with double disc clutch Lose Kupplungsscheibe / Loose clutch disc		(82) (77) (39)	
					 1863 869 028			für / for: SA 505120-01		(68)























		CODE					
--	--	------	--	--	---	---	---

MERCEDES-BENZ

ACTROS 3340 - 3550		06.96 -						
3341 A 930.183 930.182 3344 A 930.182/183 3346 A 930.182/183 3348 A 930.183 930.182	04.03-	OM541.921, OM541.947, OM541.977, OM541.991, OM541.995, OM541.946, OM541.993, OM541.949		3400 122 801 ⊕  3483 030 032  1878 005 165	430 18 MFZ430 430WGTZ	für / for: SA 591014-09 für / for: SA 504682-26 für / for: SA 504682-27	(68) (68) (68)	
	04.03-			3400 700 446 ⊕  3483 000 258  1878 005 165	430 18 MFZ430 430WGTZ	für / for: SA 504682-22/24	(68)	
	04.03-			3400 700 415 ⊕  3483 030 032  1878 002 732	430 18 MFZ430 430WGTZ	für / for: SA 504682-28	(68)	
	04.03-			3400 700 416 ⊕  3483 000 139  1878 005 165	430 18 GMFZ430N 430WGTZ	für Nebenantrieb / for PTO	(82)	
				3400 121 501 ⊕  3488 023 031  1878 002 024	400 18 MFZ2/400X 400WGTZ	Nabenprofil / Hub Profile: 45x50-18N für Fahrzeuge mit Zweischeibenkupplung / for vehicles with double disc clutch	(46) (77)	
				3400 700 355 ⊕  3488 000 158  1878 002 019	400 18 MFZ2/400X 400WGTZ	für / for: SA 504682-25 für Fahrzeuge mit Zweischeibenkupplung / for vehicles with double disc clutch	(68) (77)	
				3488 000 102 ⊕	400 GMFZ2/ 400N	für Nebenantrieb / for PTO für Fahrzeuge mit Zweischeibenkupplung / for vehicles with double disc clutch enthält eine Kupplungsscheibe / This part number includes one clutch disc	(82) (77) (66)	
				1878 002 024 ▽	400 18 400WGTZ	für Nebenantrieb / for PTO für Fahrzeuge mit Zweischeibenkupplung / for vehicles with double disc clutch Lose Kupplungsscheibe / Loose clutch disc	(82) (77) (39)	
	3341 S 934.161 3344 S 934.161 3346 S 934.161		04.03-	OM541.923, OM541.944, OM541.976, OM541.948, OM541.974, OM541.946		3400 122 801 ⊕  3483 030 032  1878 005 165	430 18 MFZ430 430WGTZ	
04.03-			3400 700 416 ⊕  3483 000 139  1878 005 165		430 18 GMFZ430N 430WGTZ	für Nebenantrieb / for PTO	(82)	
04.03-			3400 700 446 ⊕  3483 000 258  1878 005 165		430 18 MFZ430 430WGTZ	für / for: SA 504682 24	(68)	
			3400 121 501 ⊕  3488 023 031  1878 002 024		400 18 MFZ2/400X 400WGTZ	Nabenprofil / Hub Profile: 45x50-18N für Fahrzeuge mit Zweischeibenkupplung / for vehicles with double disc clutch	(46) (77)	
			3400 700 355 ⊕  3488 000 158  1878 002 019		400 18 MFZ2/400X 400WGTZ	für / for: SA 504682-25 für / for: SA 591014-08 für Fahrzeuge mit Zweischeibenkupplung / for vehicles with double disc clutch	(68) (68) (77)	
3342 L 963.026 3342 LS 963.426 3345 L 963.026 3345 LS 963.426 3348 L 963.026 3348 LS 963.426 3351 L 963.026 3351 LS 963.426	07.11-	OM471		3400 700 534 ⊕	430 18	XTend Nabenprofil / Hub Profile: 45x50-18N Abgasnorm: Euro 6 / Exhaust Emission Norm: Euro 6 max. übertragbares Motormoment [Nm] / max. transmittable engine torque [Nm]: 2600 Nur zusammen verbauen / Only install together	(46) (4) (87)	
	07.11-			3400 700 529 ⊕	430 18	XTend Getr. / GBox: Powershift Nabenprofil / Hub Profile: 45x50-18N Abgasnorm: Euro 6 / Exhaust Emission Norm: Euro 6 max. übertragbares Motormoment [Nm] / max. transmittable engine torque [Nm]: 2600 Nur zusammen verbauen / Only install together	(46) (4) (87) (51)	
	07.11-			6482 000 218	PHIS-6/38	Getr. / GBox: Powershift Abgasnorm: Euro 6 / Exhaust Emission Norm: Euro 6 Immer erneuern / Renew everytime	(4) (28)	
	07.11-							
	07.11-							
	07.11-							
3346 950.163	04.97 - 10.02	OM502LA		3400 700 415 ⊕  3483 030 032  1878 002 732	430 18 MFZ430 430WGTZ	für / for: SA504682-04	(68)	
	3348 950.162/163 3353 950.162/163	04.97 - 10.02	OM501LA		3400 122 801 ⊕  3483 030 032  1878 005 165	430 18 MFZ430 430WGTZ	für / for: SA504682-15 950.162-163	(68)
04.97 - 10.02		OM502LA		3400 121 501 ⊕  3488 023 031  1878 002 024	400 18 MFZ2/400X 400WGTZ	950.163 954.161 Nabenprofil / Hub Profile: 45x50-18N	(46)	
			3400 700 416 ⊕  3483 000 139  1878 005 165	430 18 GMFZ430N 430WGTZ	950.163 954.161 für Nebenantrieb / for PTO	(82)		
			3400 700 415 ⊕  3483 030 032	430 18 MFZ430	für / for: SA504682-04 950.162-163	(68)		

		CODE				
--	--	------	--	---	---	---









MERCEDES-BENZ

ACTROS 3340 - 3550		06.96 -				
3348 930.163 930.162 3350, 3351 930.162/163 3354, 3355 930.163 930.162	04.03-	OM501LA	 3400 122 801 ⊕ ⊗ 3483 030 032 ⊗ 1878 005 165	430 18 MFZ430 430WGTZ		
	04.03-	OM502LA	 3400 700 415 ⊕ ⊗ 3483 030 032 ⊗ 1878 002 732	430 18 MFZ430 430WGTZ		
	04.03-	OM542.940, OM542.921, OM542.960, OM542.942, OM542.962	 3400 122 801 ⊕ ⊗ 3483 030 032 ⊗ 1878 005 165	430 18 MFZ430 430WGTZ	für / for: SA 591014-09 für / for: SA 504682-26 für / for: SA 504682-27	(68) (68) (68)
			 3400 700 446 ⊕ ⊗ 3483 000 258 ⊗ 1878 005 165	430 18 MFZ430 430WGTZ	für / for: SA 504682-22/24	(68)
			 3400 700 415 ⊕ ⊗ 3483 030 032 ⊗ 1878 002 732	430 18 MFZ430 430WGTZ	für / for: SA 504682-28	(68)
			 3400 700 416 ⊕ ⊗ 3483 000 139 ⊗ 1878 005 165	430 18 GMFZ430N 430WGTZ	für Nebenantrieb / for PTO	(82)
			 3400 121 501 ⊕ ⊗ 3488 023 031 ⊗ 1878 002 024	400 18 MFZ2/400X 400WGTZ	Nabenprofil / Hub Profile: 45x50-18N für Fahrzeuge mit Zweischeibenkupplung / for vehicles with double disc clutch	(46) (77)
			 3400 700 355 ⊕ ⊗ 3488 000 158 ⊗ 1878 002 019	400 18 MFZ2/400X 400WGTZ	für / for: SA 504682-25 für Fahrzeuge mit Zweischeibenkupplung / for vehicles with double disc clutch	(68) (77)
			 3488 000 102 ⊕	400 GMFZ2/ 400N	für Nebenantrieb / for PTO für Fahrzeuge mit Zweischeibenkupplung / for vehicles with double disc clutch enthält eine Kupplungsscheibe / This part number includes one clutch disc	(82) (77) (66)
			 1878 002 024 ▽	400 18 400WGTZ	für Nebenantrieb / for PTO für Fahrzeuge mit Zweischeibenkupplung / for vehicles with double disc clutch Lose Kupplungsscheibe / Loose clutch disc	(82) (77) (39)
			 3400 700 468 ⊕ ⊗ 3483 000 422 ⊗ 1878 006 101	430 18 MFZ430 430WGTZ	Motorbauart / Engine Model: V8 Abgasnorm: Euro 4 (D4) / Exhaust Emission Norm: Euro 4 (D4)	(45) (2)
			 1863 869 028		für / for: SA 505120-01	(68)
	3348 AK 952.182 3348 AS 954.182 3348 K 952.163 952.161 3353 AS 954.182	04.97-10.02	OM501LA	 3400 122 801 ⊕ ⊗ 3483 030 032 ⊗ 1878 005 165	430 18 MFZ430 430WGTZ	für / for: SA504682-15
04.97-10.02		OM502LA	 3400 700 415 ⊕ ⊗ 3483 030 032 ⊗ 1878 002 732	430 18 MFZ430 430WGTZ	für / for: SA504682-04	(68)
04.97-10.02			 3488 000 102 ⊕	400 GMFZ2/ 400N	für / for: SA504682-08 für Nebenantrieb / for PTO enthält eine Kupplungsscheibe / This part number includes one clutch disc	(68) (82) (66)
04.97-10.02			 1878 002 024 ▽	400 18 400WGTZ	für / for: SA504682-08 für Nebenantrieb / for PTO Lose Kupplungsscheibe / Loose clutch disc	(68) (82) (39)
3348 S 954.161 3353 S 954.161 3357 S 954.161	04.97-10.02	OM501LA	 3400 122 801 ⊕ ⊗ 3483 030 032 ⊗ 1878 005 165	430 18 MFZ430 430WGTZ	für / for: SA504682-15	(68)
	04.97-10.02	OM502LA	 3400 121 501 ⊕ ⊗ 3488 023 031 ⊗ 1878 002 024	400 18 MFZ2/400X 400WGTZ	Nabenprofil / Hub Profile: 45x50-18N	(46)
	04.97-10.02		 3400 700 416 ⊕ ⊗ 3483 000 139 ⊗ 1878 005 165	430 18 GMFZ430N 430WGTZ	für Nebenantrieb / for PTO	(82)
			 3400 700 415 ⊕ ⊗ 3483 030 032 ⊗ 1878 002 732	430 18 MFZ430 430WGTZ	für / for: SA504682-04	(68)
			 3488 000 102 ⊕	400 GMFZ2/ 400N	für / for: SA504682-08 für Nebenantrieb / for PTO enthält eine Kupplungsscheibe / This part number includes one clutch disc	(68) (82) (66)
			 1878 002 024 ▽	400 18 400WGTZ	für / for: SA504682-08 für Nebenantrieb / for PTO Lose Kupplungsscheibe / Loose clutch disc	(68) (82) (39)













		CODE					
--	--	------	--	--	---	---	---

MERCEDES-BENZ

ACTROS 3340 - 3550 06.96 -







3348 S 934.161 3351 S 934.161	04.03-	OM542.940, OM542.921, OM542.960		3400 700 415 ⊕ Ⓢ 3483 030 032 ● 1878 002 732	430 18 MFZ430 430WGTZ		
	04.03-			3488 000 102 ⊕	400 GMFZ2/ 400N	für Nebenantrieb / for PTO enthält eine Kupplungsscheibe / This part number includes one clutch disc	(82) (66)
				1878 002 024 ▽	400 18 400WGTZ	für Nebenantrieb / for PTO Lose Kupplungsscheibe / Loose clutch disc	(82) (39)
				3400 121 501 ⊕ Ⓢ 3488 023 031 ● 1878 002 024	400 18 MFZ2/400X 400WGTZ	Nabenprofil / Hub Profile: 45x50-18N für Fahrzeuge mit Zweis Scheibenkupplung / for vehicles with double disc clutch	(46) (77)
				3400 700 355 ⊕ Ⓢ 3488 000 158 ● 1878 002 019	400 18 MFZ2/400X 400WGTZ	für / for: SA 504682-25 für / for: SA 591014-08 für Fahrzeuge mit Zweis Scheibenkupplung / for vehicles with double disc clutch	(68) (68) (77)
				3400 700 468 ⊕ Ⓢ 3483 000 422 ● 1878 006 101	430 18 MFZ430 430WGTZ	Motorbauart / Engine Model: V8 Abgasnorm: Euro 4 (D4) / Exhaust Emission Norm: Euro 4 (D4)	(45) (2)
3350 S 934.251 3358 930.162	06.09- 04.03-	OM542.940, OM542.944		3400 700 468 ⊕ Ⓢ 3483 000 422 ● 1878 006 101	430 18 MFZ430 430WGTZ	Motorbauart / Engine Model: V8 Abgasnorm: Euro 4 (D4) / Exhaust Emission Norm: Euro 4 (D4)	(45) (2)
3357 950.162	04.97-10.02	OM501LA		3400 122 801 ⊕ Ⓢ 3483 030 032 ● 1878 005 165	430 18 MFZ430 430WGTZ	für / for: SA504682-15	(68)













ACTROS 4036 - 4841 06.96 -

4140 AK 932.336 4140 K 932.325 4140 K 932.315 932.317 932.314 4144 K 932.317 932.315 932.314	04.03-	OM541.976, OM541.923, OM541.944, OM541.945, OM541.946, OM541.924, OM541.925		3400 122 801 ⊕ Ⓢ 3483 030 032 ● 1878 005 165	430 18 MFZ430 430WGTZ		
	04.03-			3400 700 416 ⊕ Ⓢ 3483 000 139 ● 1878 005 165	430 18 GMFZ430N 430WGTZ	für Nebenantrieb / for PTO	(82)
				3400 700 446 ⊕ Ⓢ 3483 000 258 ● 1878 005 165	430 18 MFZ430 430WGTZ	für / for: SA 504682 24	(68)
				3400 121 501 ⊕ Ⓢ 3488 023 031 ● 1878 002 024	400 18 MFZ2/400X 400WGTZ	Nabenprofil / Hub Profile: 45x50-18N für Fahrzeuge mit Zweis Scheibenkupplung / for vehicles with double disc clutch	(46) (77)
				3400 700 355 ⊕ Ⓢ 3488 000 158 ● 1878 002 019	400 18 MFZ2/400X 400WGTZ	für / for: SA 504682-25 für / for: SA 591014-08 für Fahrzeuge mit Zweis Scheibenkupplung / for vehicles with double disc clutch	(68) (68) (77)
4140 AK 952.336 4143 AK 952.336 4148 AK 952.336	04.97-10.02	OM501LA		3400 122 801 ⊕ Ⓢ 3483 030 032 ● 1878 005 165	430 18 MFZ430 430WGTZ	für / for: SA504682-15	(68)
4140 B 953.314 953.317	04.97-10.02	OM501LA		3400 700 415 ⊕ Ⓢ 3483 030 032 ● 1878 002 732	430 18 MFZ430 430WGTZ	für / for: SA504682-04	(68)
		OM502LA		3400 122 801 ⊕ Ⓢ 3483 030 032 ● 1878 005 165	430 18 MFZ430 430WGTZ	für / for: SA504682-15 Je nach Kundenwunsch mit unterschiedlicher Kupplung / Equipped with different clutch according to customer requirement	(33)
			3400 121 501 ⊕ Ⓢ 3488 023 031 ● 1878 002 024	400 18 MFZ2/400X 400WGTZ	953.314 Nabenprofil / Hub Profile: 45x50-18N Je nach Kundenwunsch mit unterschiedlicher Kupplung / Equipped with different clutch according to customer requirement	(46) (33)	
4140 K 952.314 952.317 952.315 4143 K 952.317 952.314/315	04.97-10.02	OM501LA		3400 700 416 ⊕ Ⓢ 3483 000 139 ● 1878 005 165	430 18 GMFZ430N 430WGTZ	für Nebenantrieb / for PTO	(82)
4140 K 952.314 952.317 952.315 4143 K 952.317 952.314/315	04.97-10.02	OM501LA		3400 122 801 ⊕ Ⓢ 3483 030 032 ● 1878 005 165	430 18 MFZ430 430WGTZ	für / for: SA504682/15 952.314-315/317	(68)
		OM502LA		3400 700 415 ⊕ Ⓢ 3483 030 032 ● 1878 002 732	430 18 MFZ430 430WGTZ	für / for: SA504682-04 952.314-315	(68)

		CODE				
--	--	------	--	---	---	---

MERCEDES-BENZ

ACTROS 4036 - 4841		06.96 -				
4140 K 952.325 4143 K 952.325 4148 K 952.325	04.97 - 10.02	OM501LA	 3400 122 801 ⊕ ⊕ 3483 030 032 ⊕ 1878 005 165	430 18 MFZ430 430WGTZ	für / for: SA504682-15	(68)
	04.97 - 10.02	OM502LA	 3400 700 415 ⊕ ⊕ 3483 030 032 ⊕ 1878 002 732	430 18 MFZ430 430WGTZ	für / for: SA504682-04	(68)
	04.97 - 10.02	OM541.945, OM541.921, OM541.947, OM542.925, OM541.924	 3400 121 501 ⊕ ⊕ 3488 023 031 ⊕ 1878 002 024	400 18 MFZ2/400X 400WGTZ	Nabenprofil / Hub Profile: 45x50-18N für Fahrzeuge mit Zweischeibenkupplung / for vehicles with double disc clutch	(46) (77)
4148 K 952.314/315	04.97 - 10.02	OM501LA	 3400 122 801 ⊕ ⊕ 3483 030 032 ⊕ 1878 005 165	430 18 MFZ430 430WGTZ	für / for: SA504682-15	(68)
		OM502LA	 3400 700 415 ⊕ ⊕ 3483 030 032 ⊕ 1878 002 732	430 18 MFZ430 430WGTZ	für / for: SA504682-04	(68)
			 3488 000 102 ⊕	400 GMFZ2/ 400N	für / for: SA504682-08 für Nebenantrieb / for PTO enthält eine Kupplungsscheibe / This part number includes one clutch disc	(68) (82) (66)
			 1878 002 024 ▽	400 18 400WGTZ	für / for: SA504682-08 für Nebenantrieb / for PTO Lose Kupplungsscheibe / Loose clutch disc	(68) (82) (39)

ATEGO 712 - 717							
712 970.002/003 970.005 970.013 970.017 970.001 970.012 970.015 970.011 712, 713 970.011/012 970.001 970.017 970.005 970.013 970.002 970.015 970.003 714 K 972.011 714, 714 L 970.215 970.015 970.213 970.003 970.005 970.012 970.017 970.013 970.205 970.217 970.002 970.011 970.001 970.203 715, 715 L, 716, 716 L 970.005 970.205 970.015 970.203 970.001-003 970.017 715,715 L 970.005 970.002/003 970.205 970.017 970.001 970.203 717 K 972.011 717, 717 L 970.015 970.215 970.017 970.213 970.011 970.217 970.013 970.012	01.98 - 10.04	OM904	 3400 127 701 ⊖ ⊕ 3482 000 462 ⊕ 1878 052 842	362 18 MF362 362WGTB			
	10.04 -		 3400 700 484 HD ● ⊖ ⊕ 3482 000 462 ⊕ 1878 001 939	362 10 MF362 362WGTB			
		01.98 - 10.04	OM904	 3400 710 005 ⊕ 3482 000 462 ⊕ 1878 052 842 ↘ 3182 998 501	362 18 MF362 362WGTB HHIS-3	ohne Sensor / without sensor Füllmedium: Bremsflüssigkeit / Fill Medium: Brake Fluid	(104) (23)
		01.98 - 10.04		 3400 710 008 ⊕ 3482 000 462 ⊕ 1878 052 842 ↘ 3182 600 101	362 18 MF362 362WGTB HHIS-3	mit Sensor / with sensor Füllmedium: Bremsflüssigkeit / Fill Medium: Brake Fluid	(92) (23)
		10.04 -	OM906	 3400 121 201 ⊖ ⊕ 3482 000 464 ⊕ 1878 023 931	395 18 MF395 395GTZ		
		01.98 - 10.04		 3400 710 009 ⊕ 3482 000 464 ⊕ 1878 023 931 ↘ 3182 600 101	395 18 MF395 395GTZ HHIS-3	mit Sensor / with sensor Füllmedium: Bremsflüssigkeit / Fill Medium: Brake Fluid	(92) (23)
		01.98 - 10.04	OM904, OM906	 3400 710 006 ⊕ 3482 000 464 ⊕ 1878 023 931 ↘ 3182 998 501	395 18 MF395 395GTZ HHIS-3	ohne Sensor / without sensor Füllmedium: Bremsflüssigkeit / Fill Medium: Brake Fluid	(104) (23)
		01.98 - 10.04		 3400 710 016 ⊕ 3482 000 464 ⊕ 1878 023 931 ↘ 3182 600 141	395 18 MF395 395GTZ	ohne Sensor / without sensor Füllmedium: Mineralöl / Fill Medium: Mineral Oil	(104) (24)
			OM904, OM906	 3182 600 101	HHIS-3	mit Sensor / with sensor Füllmedium: Bremsflüssigkeit / Fill Medium: Brake Fluid Immer erneuern / Renew everytime	(92) (23) (28)
				 3182 998 501	HHIS-3	ohne Sensor / without sensor Füllmedium: Bremsflüssigkeit / Fill Medium: Brake Fluid Immer erneuern / Renew everytime	(104) (23) (28)
				 3182 600 141		ohne Sensor / without sensor Füllmedium: Mineralöl / Fill Medium: Mineral Oil Immer erneuern / Renew everytime	(104) (24) (28)
				 3151 000 396 ⊕	KZIS-4	Getr. / GBox: G6-60, 715.050	





















MERCEDES-BENZ

ATEGO 712 - 717

716 K 967.201 716, 716 L 967.001 967.021 716, 716 L 967.020 967.000 718 K 967.201 718, 718 L 967.001 967.021 721 K 967.201 721, 721 L 967.001 967.021 723 K 967.201 723, 723 L 967.021 967.001		OM934.911, OM934.913		6482 000 219	PHIS-5/34	Getr. / GBox: Powershift Abgasnorm: Euro 6 / Exhaust Emission Norm: Euro 6 Immer erneuern / Renew everytime	(4) (28)
--	--	-------------------------	---	---------------------	-----------	---	-------------



































































		CODE				
--	--	------	--	---	---	---

MERCEDES-BENZ

ATEGO 812 - 830						
812 970.015 970.017 970.011-013	01.98-10.04	OM904	 3400 127 701  ⊗ 3482 000 462 ⊗ 1878 052 842	362 18 MF362 362WGTB		
812 K 970.011 970.013 970.017 970.015 970.012	10.04-		 3400 700 484 HD  ⊗ 3482 000 462 ⊗ 1878 001 939	362 10 MF362 362WGTB		
812, 813 970.011/012 970.017 970.013 970.015	10.04-		 3400 710 005 ⊗ 3482 000 462 ⊗ 1878 052 842 ↘ 3182 998 501	362 18 MF362 362WGTB HHIS-3	ohne Sensor / without sensor Füllmedium: Bremsflüssigkeit / Fill Medium: Brake Fluid	(104) (23)
814 K 972.011/012	01.98-10.04		 3400 710 008 ⊗ 3482 000 462 ⊗ 1878 052 842 ↘ 3182 600 101	362 18 MF362 362WGTB HHIS-3	mit Sensor / with sensor Füllmedium: Bremsflüssigkeit / Fill Medium: Brake Fluid	(92) (23)
814 K 972.011 972.021	01.98-10.04		 3400 700 397 ⊗ 3482 000 463 ⊗ 1878 004 232	395 18 MF395 395WGTZ	für / for: SA 504672/22	(68)
814, 814 L 970.025 970.021 970.023 970.223 970.227 970.027 970.225 970.022	01.98-10.04		 3400 121 201  ⊗ 3482 000 464 ⊗ 1878 023 931	395 18 MF395 395GTZ		
815 F 976.013 976.011/012	01.98-10.04	OM906	 3400 121 301 HD  ⊗ 3482 000 463 ⊗ 1878 023 831	395 18 MF395 395GTZ	für Fahrzeuge mit Kupplungskraftverstärker / for vehicles with clutch booster	(72)
815 K 972.011 972.022 972.012 972.021	01.98-10.04		 3400 710 006 ⊗ 3482 000 464 ⊗ 1878 023 931 ↘ 3182 998 501	395 18 MF395 395GTZ HHIS-3	ohne Sensor / without sensor Füllmedium: Bremsflüssigkeit / Fill Medium: Brake Fluid	(104) (23)
815 K 972.011/012 972.021/022 972.032	01.98-10.04		 3400 710 007 HD ⊗ 3482 000 463 ⊗ 1878 023 831 ↘ 3182 998 501	395 18 MF395 395GTZ HHIS-3	für Fahrzeuge mit Kupplungskraftverstärker / for vehicles with clutch booster ohne Sensor / without sensor	(72) (104)
815 K, 816 K 972.011/012	10.04-		 3400 710 009 ⊗ 3482 000 464 ⊗ 1878 023 931 ↘ 3182 600 101	395 18 MF395 395GTZ HHIS-3	Füllmedium: Bremsflüssigkeit / Fill Medium: Brake Fluid	(92) (23)
815 K, 816 K 972.021/022 972.011	10.04-		 3400 710 010 HD ⊗ 3482 000 463 ⊗ 1878 023 831 ↘ 3182 600 101	395 18 MF395 395GTZ HHIS-3	für Fahrzeuge mit Kupplungskraftverstärker / for vehicles with clutch booster mit Sensor / with sensor	(72) (92)
815, 815 L 970.025 970.015 970.023 970.223 970.021/022 970.027 970.225 970.227	01.98-10.04		 3400 710 012 ⊗ 3482 000 464 ⊗ 1878 023 931 ↘ 3182 600 172	395 18 MF395 395GTZ	Füllmedium: Bremsflüssigkeit / Fill Medium: Brake Fluid	(92) (23)
815, 815 L, 816, 816 L 970.012 970.015 970.023 970.027 970.213 970.017 970.211 970.022 970.215 970.013 970.025 970.217 970.011 970.212 970.021	10.04-		 3400 710 013 HD ⊗ 3482 000 463 ⊗ 1878 023 831 ↘ 3182 600 172	395 18 MF395 395GTZ	für / for: SA 504673/26 Kabellänge [mm] / Cable Length [mm]: 220 mit Sensor / with sensor Füllmedium: Mineralöl / Fill Medium: Mineral Oil	(68) (34) (92) (24)
815,815 L 970.012 970.217 970.015 970.211 970.017 970.011 970.013 970.212 970.215 970.213	01.98-10.04		 3400 710 015 ⊗ 3482 000 464 ⊗ 1878 023 931 ↘ 3182 600 166	395 18 MF395 395GTZ	für / for: SA 504673/26 Kabellänge [mm] / Cable Length [mm]: 220 für Fahrzeuge mit Kupplungskraftverstärker / for vehicles with clutch booster mit Sensor / with sensor Füllmedium: Mineralöl / Fill Medium: Mineral Oil	(68) (34) (72) (92) (24)
816, 816 L 970.027 970.223 970.022 970.025 970.023 970.225 970.021 970.227	10.04-		 3400 710 014 HD ⊗ 3482 000 463 ⊗ 1878 023 831 ↘ 3182 600 166	395 18 MF395 395GTZ	mit Sensor / with sensor Füllmedium: Mineralöl / Fill Medium: Mineral Oil	(92) (24)
817 K 972.032 972.012 972.022 972.011 972.021	01.98-10.04		 3400 710 016 ⊗ 3482 000 464 ⊗ 1878 023 931 ↘ 3182 600 141	395 18 MF395 395GTZ	für Fahrzeuge mit Kupplungskraftverstärker / for vehicles with clutch booster mit Sensor / with sensor Füllmedium: Mineralöl / Fill Medium: Mineral Oil	(72) (92) (24)
817 K 972.011/012	01.98-10.04		 3400 710 017 HD ⊗ 3482 000 463 ⊗ 1878 023 831 ↘ 3182 600 141	395 18 MF395 395GTZ	ohne Sensor / without sensor Füllmedium: Mineralöl / Fill Medium: Mineral Oil	(104) (24)
817, 817 L 970.021 970.027 970.223 970.022/023 970.225 970.227 970.025	01.98-10.04					
817, 817 L 970.025 970.023 970.217 970.211-213 970.011 970.017 970.027 970.012 970.215 970.015 970.013 970.021/022	01.98-10.04					
818 K 972.022 972.011 972.021 972.012	10.04-					
818 K 972.011/012	10.04-					

		CODE				
--	--	------	--	---	---	---

MERCEDES-BENZ

ATEGO 812 - 830							
818, 818 L 970.025 970.027 970.023 970.223 970.021/022 970.225 970.227	10.04-	OM904		3400 127 701   3482 000 462  1878 052 842	362 18 MF362 362WGTB		
	818, 818 L 970.211 970.021 970.025 970.027 970.013 970.017 970.022/023 970.215 970.011/012 970.015 970.212/213 970.217		10.04-		3400 700 484 HD   3482 000 462  1878 001 939	362 10 MF362 362WGTB	
822 K 972.012 972.011		10.04-	OM906		3400 710 005  3482 000 462  1878 052 842  3182 998 501	362 18 MF362 362WGTB HHIS-3	ohne Sensor / without sensor Füllmedium: Bremsflüssigkeit / Fill Medium: Brake Fluid
	822 K 972.021 972.012 972.032 972.022	10.04-			3400 710 008  3482 000 462  1878 052 842  3182 600 101	362 18 MF362 362WGTB HHIS-3	mit Sensor / with sensor Füllmedium: Bremsflüssigkeit / Fill Medium: Brake Fluid
822, 822 L 970.211 970.015 970.025 970.225 970.212/213 970.223 970.017 970.022/023 970.215 970.027 970.021 970.227		10.04-	OM906		3400 700 397  3482 000 463  1878 004 232	395 18 MF395 395WGTZ	für / for: SA 504672/22
	822, 822 L 970.023 970.017 970.212 970.215 970.012 970.022 970.021 970.213 970.011 970.013 970.211 970.217 970.015 970.025 970.027	10.04-			3400 121 201   3482 000 464  1878 023 931	395 18 MF395 395GTZ	
822, 822 L 970.023 970.017 970.212 970.215 970.012 970.022 970.021 970.213 970.011 970.013 970.211 970.217 970.015 970.025 970.027		10.04-	OM906		3400 121 301 HD   3482 000 463  1878 023 831	395 18 MF395 395GTZ	für Fahrzeuge mit Kupplungskraftverstärker / for vehicles with clutch booster
	823 K 972.021/022 972.032	01.98-10.04			3400 710 006  3482 000 464  1878 023 931  3182 998 501	395 18 MF395 395GTZ HHIS-3	ohne Sensor / without sensor Füllmedium: Bremsflüssigkeit / Fill Medium: Brake Fluid
823, 823 L 970.225 970.021 970.023 970.025 970.027 970.222 970.227 970.223 970.022 970.221		01.98-10.04	OM906		3400 710 007 HD  3482 000 463  1878 023 831  3182 998 501	395 18 MF395 395GTZ HHIS-3	für Fahrzeuge mit Kupplungskraftverstärker / for vehicles with clutch booster ohne Sensor / without sensor Füllmedium: Bremsflüssigkeit / Fill Medium: Brake Fluid
	823, 823 L, 824, 824 L 970.023 970.225 970.227 970.222 970.025 970.221 970.223 970.021/022 970.027	10.04-			3400 710 009  3482 000 464  1878 023 931  3182 600 101	395 18 MF395 395GTZ HHIS-3	mit Sensor / with sensor Füllmedium: Bremsflüssigkeit / Fill Medium: Brake Fluid
824 K 972.011/012 972.021/022		10.04-	OM906		3400 710 010 HD  3482 000 463  1878 023 831  3182 600 101	395 18 MF395 395GTZ HHIS-3	für Fahrzeuge mit Kupplungskraftverstärker / for vehicles with clutch booster mit Sensor / with sensor Füllmedium: Bremsflüssigkeit / Fill Medium: Brake Fluid
	824 K 972.011/012 972.021/022	10.04-			3400 710 012  3482 000 464  1878 023 931  3182 600 172	395 18 MF395 395GTZ	für / for: SA 504673/26 Kabellänge [mm] / Cable Length [mm]: 220 mit Sensor / with sensor Füllmedium: Mineralöl / Fill Medium: Mineral Oil
824 K 972.011/012 972.021/022		10.04-	OM906		3400 710 013 HD  3482 000 463  1878 023 831  3182 600 172	395 18 MF395 395GTZ	für / for: SA 504673/26 Kabellänge [mm] / Cable Length [mm]: 220 für Fahrzeuge mit Kupplungskraftverstärker / for vehicles with clutch booster mit Sensor / with sensor Füllmedium: Mineralöl / Fill Medium: Mineral Oil
	824 K 972.011/012 972.021/022	10.04-			3400 710 015  3482 000 464  1878 023 931  3182 600 166	395 18 MF395 395GTZ	mit Sensor / with sensor Füllmedium: Mineralöl / Fill Medium: Mineral Oil
824 K 972.011/012 972.021/022		10.04-	OM906		3400 710 014 HD  3482 000 463  1878 023 831  3182 600 166	395 18 MF395 395GTZ	für Fahrzeuge mit Kupplungskraftverstärker / for vehicles with clutch booster mit Sensor / with sensor Füllmedium: Mineralöl / Fill Medium: Mineral Oil
	824 K 972.011/012 972.021/022	10.04-			3400 710 016  3482 000 464  1878 023 931  3182 600 141	395 18 MF395 395GTZ	ohne Sensor / without sensor Füllmedium: Mineralöl / Fill Medium: Mineral Oil
824 K 972.011/012 972.021/022		10.04-	OM906		3400 710 017 HD  3482 000 463  1878 023 831  3182 600 141	395 18 MF395 395GTZ	für Fahrzeuge mit Kupplungskraftverstärker / for vehicles with clutch booster ohne Sensor / without sensor Füllmedium: Mineralöl / Fill Medium: Mineral Oil





























































		CODE				
--	--	------	--	---	---	---

MERCEDES-BENZ

ATEGO 812 - 830							
816 K 967.202 816 K 967.201 816, 816 L 967.002 967.022 816, 816 L 967.001 967.021 818 K 967.202 818 K 967.201 818, 818 L 967.022 967.002 818, 818 L 967.021 967.001 821 K 967.201 821 K 967.202 821, 821 L 967.001 967.021 821, 821 L 967.002 967.022 823 K 967.202 823 K 967.201 823, 823 L 967.022 967.002 823, 823 L 967.001 967.021 824 K 967.202 824, 824 L 967.022 967.002		OM934.913, OM934.911		6482 000 219	PHIS-5/34	Getr. / GBox: Powershift Abgasnorm: Euro 6 / Exhaust Emission Norm: Euro 6 Immer erneuern / Renew everytime	(4) (28)

		CODE					
--	--	------	--	--	---	---	---

MERCEDES-BENZ











































































ATEGO 914 - 930										
915 AF 976.332-333 915, 915 L, 916, 916 L 970.032 970.035 970.237 970.031 970.233 970.037 970.033 970.235 916 K 972.031/032 917 AF 976.334 976.332/333 917 K 972.022 972.032 972.031 917 KO 975.031 917, 917 L 970.035 970.237 970.032 970.037 970.235 970.233 970.033 970.031 918 K 972.031/032 918, 918 L 970.033 970.037 970.235 970.237 970.031 970.233 970.035 970.032 922 K 972.031 972.022 972.032 922, 922 L 970.037 970.033 970.032 970.035 970.235 970.031 970.233 970.237 923 K 972.022 972.031 923, 923 L 970.033 970.233 970.235 970.031 970.037 970.035 970.032 970.237 923, 923 L, 924, 924 L 970.031 970.237 970.033 970.035 970.032 970.037 970.233 970.235 924 K 972.031/032 925 AF 976.332 976.334 976.333	10.04-	OM904		3400 127 701   3482 000 462  1878 052 842	362 18 MF362 362WGTB					
					3400 700 484 HD   3482 000 462  1878 001 939	362 10 MF362 362WGTB				
			10.04-			3400 710 005  3482 000 462  1878 052 842  3182 998 501	362 18 MF362 362WGTB HHIS-3	ohne Sensor / without sensor Füllmedium: Bremsflüssigkeit / Fill Medium: Brake Fluid	(104) (23)	
			01.98-10.04			3400 710 008  3482 000 462  1878 052 842  3182 600 101	362 18 MF362 362WGTB HHIS-3	mit Sensor / with sensor Füllmedium: Bremsflüssigkeit / Fill Medium: Brake Fluid	(92) (23)	
			01.98-10.04			3400 700 397  3482 000 463  1878 004 232	395 18 MF395 395WGTZ	für / for: SA 504672/22	(68)	
			10.04-	OM906		3400 121 201   3482 000 464  1878 023 931	395 18 MF395 395GTZ			
			10.04-			3400 121 301 HD   3482 000 463  1878 023 831	395 18 MF395 395GTZ	für Fahrzeuge mit Kupplungskraftverstärker / for vehicles with clutch booster	(72)	
			10.04-			3400 710 006  3482 000 464  1878 023 931  3182 998 501	395 18 MF395 395GTZ HHIS-3	ohne Sensor / without sensor Füllmedium: Bremsflüssigkeit / Fill Medium: Brake Fluid	(104) (23)	
			10.04-			3400 710 007 HD  3482 000 463  1878 023 831  3182 998 501	395 18 MF395 395GTZ HHIS-3	für Fahrzeuge mit Kupplungskraftverstärker / for vehicles with clutch booster ohne Sensor / without sensor Füllmedium: Bremsflüssigkeit / Fill Medium: Brake Fluid	(72) (104) (23)	
			01.98-10.04			3400 710 009  3482 000 464  1878 023 931  3182 600 101	395 18 MF395 395GTZ HHIS-3	mit Sensor / with sensor Füllmedium: Bremsflüssigkeit / Fill Medium: Brake Fluid	(92) (23)	
			01.98-10.04			3400 710 010 HD  3482 000 463  1878 023 831  3182 600 101	395 18 MF395 395GTZ HHIS-3	für Fahrzeuge mit Kupplungskraftverstärker / for vehicles with clutch booster mit Sensor / with sensor Füllmedium: Bremsflüssigkeit / Fill Medium: Brake Fluid	(72) (92) (23)	
			10.04-			3400 710 015  3482 000 464  1878 023 931  3182 600 166	395 18 MF395 395GTZ	mit Sensor / with sensor Füllmedium: Mineralöl / Fill Medium: Mineral Oil	(92) (24)	
			10.04-			3400 710 014 HD  3482 000 463  1878 023 831  3182 600 166	395 18 MF395 395GTZ	für Fahrzeuge mit Kupplungskraftverstärker / for vehicles with clutch booster mit Sensor / with sensor Füllmedium: Mineralöl / Fill Medium: Mineral Oil	(72) (92) (24)	
			01.98-10.04			3400 710 016  3482 000 464  1878 023 931  3182 600 141	395 18 MF395 395GTZ	ohne Sensor / without sensor Füllmedium: Mineralöl / Fill Medium: Mineral Oil	(104) (24)	
						3400 710 017 HD  3482 000 463  1878 023 831  3182 600 141	395 18 MF395 395GTZ	für Fahrzeuge mit Kupplungskraftverstärker / for vehicles with clutch booster ohne Sensor / without sensor Füllmedium: Mineralöl / Fill Medium: Mineral Oil	(72) (104) (24)	
					OM904, 906		3182 600 101	HHIS-3	mit Sensor / with sensor Füllmedium: Bremsflüssigkeit / Fill Medium: Brake Fluid Immer erneuern / Renew everytime	(92) (23) (28)
							3182 600 141		ohne Sensor / without sensor Füllmedium: Mineralöl / Fill Medium: Mineral Oil Immer erneuern / Renew everytime	(104) (24) (28)
						3182 600 166		mit Sensor / with sensor Füllmedium: Mineralöl / Fill Medium: Mineral Oil Immer erneuern / Renew everytime	(92) (24) (28)	
						3182 998 501	HHIS-3	ohne Sensor / without sensor Füllmedium: Bremsflüssigkeit / Fill Medium: Brake Fluid Immer erneuern / Renew everytime	(104) (23) (28)	
						3151 000 396	KZIS-4			

MERCEDES-BENZ

ATEGO 914 - 930							
916 K 967.203 916, 916 L 967.023 967.003 918 AF 967.633 918 F 967.603 918 K 967.203 918, 918 L 967.023 967.003 921 K 967.203 921, 921 L 967.003 967.023 923 AF 967.633 923 F 967.603 923 K 967.203 923, 923 L 967.003 967.023 924 K 967.203 924, 924 L 967.023 967.003 927 AF 967.633 927 F 967.603		OM934.911, OM934.913		6482 000 219	PHIS-5/34	Getr. / GBox: Powershift Abgasnorm: Euro 6 / Exhaust Emission Norm: Euro 6 Immer erneuern / Renew everytime	(4) (28)

		CODE				
--	--	------	--	---	---	---

MERCEDES-BENZ

ATEGO 1014 - 1118								
1015 K 972.042	10.04-	OM904		3400 127 701   3482 000 462  1878 052 842	362 18 MF362 362WGTB			
1015 K, 1016 K 972.041/042	10.04-			3400 700 484 HD   3482 000 462  1878 001 939	362 10 MF362 362WGTB			
1016, 1016 L 970.041-043 970.247 970.047 970.245 970.045 970.243	10.04-			3400 710 005   3482 000 462  1878 052 842  3182 998 501	362 18 MF362 362WGTB HHIS-3	ohne Sensor / without sensor Füllmedium: Bremsflüssigkeit / Fill Medium: Brake Fluid	(104) (23)	
1017 A 970.342	01.98-10.04			3400 710 008   3482 000 462  1878 052 842  3182 600 101	362 18 MF362 362WGTB HHIS-3	mit Sensor / with sensor Füllmedium: Bremsflüssigkeit / Fill Medium: Brake Fluid	(92) (23)	
1017 AK 972.342	01.98-10.04			3400 700 397   3482 000 463  1878 004 232	395 18 MF395 395WGTZ	für / for: SA 504672/22	(68)	
1017 K 972.041/042	01.98-10.04		OM906		3400 121 201   3482 000 464  1878 023 931	395 18 MF395 395GTZ		
1017 K, 1018 K 972.041/042	10.04-				3400 121 301 HD   3482 000 463  1878 023 831	395 18 MF395 395GTZ	für Fahrzeuge mit Kupplungskraftverstärker / for vehicles with clutch booster	(72)
1017 KO, 1018 KO 975.041	01.98-10.04				3400 710 006   3482 000 464  1878 023 931  3182 998 501	395 18 MF395 395GTZ HHIS-3	ohne Sensor / without sensor Füllmedium: Bremsflüssigkeit / Fill Medium: Brake Fluid	(104) (23)
1017, 1017 L 970.247 970.243 970.042/043 970.045 970.047 970.041 970.245	01.98-10.04				3400 710 007 HD   3482 000 463  1878 023 831  3182 998 501	395 18 MF395 395GTZ HHIS-3	für Fahrzeuge mit Kupplungskraftverstärker / for vehicles with clutch booster ohne Sensor / without sensor	(72) (104) (23)
1018 A 970.342	10.04-				3400 710 009   3482 000 464  1878 023 931  3182 600 101	395 18 MF395 395GTZ HHIS-3	mit Sensor / with sensor Füllmedium: Bremsflüssigkeit / Fill Medium: Brake Fluid	(92) (23)
1018, 1018 L 970.042 970.247 970.043 970.045 970.243 970.047 970.245 970.041	10.04-			3400 710 010 HD   3482 000 463  1878 023 831  3182 600 101	395 18 MF395 395GTZ HHIS-3	für Fahrzeuge mit Kupplungskraftverstärker / for vehicles with clutch booster mit Sensor / with sensor	(72) (92) (23)	
1022 K 972.042 972.041	10.04-			3400 710 015   3482 000 464  1878 023 931  3182 600 166	395 18 MF395 395GTZ	mit Sensor / with sensor Füllmedium: Mineralöl / Fill Medium: Mineral Oil	(92) (24)	
1022, 1022 L 970.041 970.243 970.245 970.042/043 970.247 970.047 970.045	10.04-			3400 710 014 HD   3482 000 463  1878 023 831  3182 600 166	395 18 MF395 395GTZ	für Fahrzeuge mit Kupplungskraftverstärker / for vehicles with clutch booster mit Sensor / with sensor	(72) (92) (24)	
1023 A, 1024 A 970.342	10.04-			3400 710 016   3482 000 464  1878 023 931  3182 600 141	395 18 MF395 395GTZ	ohne Sensor / without sensor Füllmedium: Mineralöl / Fill Medium: Mineral Oil	(104) (24)	
1023 K 972.041/042	01.98-10.04			3400 710 017 HD   3482 000 463  1878 023 831  3182 600 141	395 18 MF395 395GTZ	für Fahrzeuge mit Kupplungskraftverstärker / for vehicles with clutch booster ohne Sensor / without sensor	(72) (104) (24)	
1023, 1023 L 970.041 970.045 970.243 970.247 970.245 970.042/043 970.047	01.98-10.04	OM904, 906		3182 600 101	HHIS-3	mit Sensor / with sensor Füllmedium: Bremsflüssigkeit / Fill Medium: Brake Fluid Immer erneuern / Renew everytime	(92) (23) (28)	
1023, 1023 L, 1024, 1024 L 970.243 970.247 970.041-043 970.045 970.047 970.245	10.04-			3182 600 141		ohne Sensor / without sensor Füllmedium: Mineralöl / Fill Medium: Mineral Oil Immer erneuern / Renew everytime	(104) (24) (28)	
1024 K 972.042 972.041	10.04-			3182 600 166		mit Sensor / with sensor Füllmedium: Mineralöl / Fill Medium: Mineral Oil Immer erneuern / Renew everytime	(92) (24) (28)	
				3182 998 501		HHIS-3	ohne Sensor / without sensor Füllmedium: Bremsflüssigkeit / Fill Medium: Brake Fluid Immer erneuern / Renew everytime	(104) (23) (28)
				3151 000 396		KZIS-4		





























































MERCEDES-BENZ

ATEGO 1014 - 1118

1016 K 967.204 1016, 1016 L 967.004 967.024 1018 A 967.034 1018 AK 967.234 1018 K 967.204 1018 KO 967.504 1018, 1018 L 967.024 967.004 1021 A 967.034 1021 AK 967.234 1021 K 967.204 1021 KO 967.504 1021, 1021 L 967.024 967.004 1023 A 967.034 1023 AK 967.234 1023 K 967.204 1023 KO 967.504 1023, 1023 L 967.004 967.024 1024 A 967.034 1024 AK 967.234 1024 K 967.204 1024, 1024 L 967.004 967.024	OM934.913, OM934.911		6482 000 219	PHIS-5/34	Getr. / GBox: Powershift Abgasnorm: Euro 6 / Exhaust Emission Norm: Euro 6 Immer erneuern / Renew everytime	(4) (28)
---	-------------------------	---	---------------------	-----------	---	-------------





























































		CODE				
--	--	------	--	---	---	---

MERCEDES-BENZ

ATEGO 1214 - 1229						
1214, 1214 L 970.083 970.053 970.057 970.085 970.088 970.253 970.283 970.087 970.257/258 970.285 970.058 970.287 970.255 970.055	01.98-10.04	OM904		3400 127 701   3482 000 462  1878 052 842	362 18 MF362 362WGTB	
				3400 700 484 HD   3482 000 462  1878 001 939	362 10 MF362 362WGTB	
1215 K 972.052	01.98-10.04			3400 710 005  3482 000 462  1878 052 842  3182 998 501	362 18 MF362 362WGTB HHIS-3	ohne Sensor / without sensor Füllmedium: Bremsflüssigkeit / Fill Medium: Brake Fluid (104) (23)
1215, 1215 L 375.101 970.253 970.055 970.053 970.255 970.257/258 970.057/058 375.102	01.98-10.04			3400 710 008  3482 000 462  1878 052 842  3182 600 101	362 18 MF362 362WGTB HHIS-3	mit Sensor / with sensor Füllmedium: Bremsflüssigkeit / Fill Medium: Brake Fluid (92) (23)
1215, 1215 L, 1216, 1216 L 970.058 970.087 970.287 970.285 970.057 970.053 970.253 970.283 970.055 970.255 970.257 970.083 970.085 970.258 970.288 970.088	10.04-			3400 700 397  3482 000 463  1878 004 232	395 18 MF395 395WGTZ	für / for: SA 504672/22 (68)
1216 K 972.052	10.04-	OM906		3400 121 201   3482 000 464  1878 023 931	395 18 MF395 395GTZ	
1217 K 972.052/053	01.98-10.04			3400 121 301 HD   3482 000 463  1878 023 831	395 18 MF395 395GTZ	für Fahrzeuge mit Kupplungskraftverstärker / for vehicles with clutch booster (72)
1217 KO 975.052	01.98-10.04			3400 710 006  3482 000 464  1878 023 931  3182 998 501	395 18 MF395 395GTZ HHIS-3	ohne Sensor / without sensor Füllmedium: Bremsflüssigkeit / Fill Medium: Brake Fluid (104) (23)
1217, 1217 L 970.053 970.085 970.258 970.285 970.288 970.087 970.055 970.058 970.083 970.057 970.287 970.255 970.283 970.050 970.253 970.059 970.257 970.088	01.98-10.04			3400 710 007 HD  3482 000 463  1878 023 831  3182 998 501	395 18 MF395 395GTZ HHIS-3	für Fahrzeuge mit Kupplungskraftverstärker / for vehicles with clutch booster (72) ohne Sensor / without sensor (104) Füllmedium: Bremsflüssigkeit / Fill Medium: Brake Fluid (23)
1218 K 972.052/053	10.04-			3400 710 009  3482 000 464  1878 023 931  3182 600 101	395 18 MF395 395GTZ HHIS-3	mit Sensor / with sensor Füllmedium: Bremsflüssigkeit / Fill Medium: Brake Fluid (92) (23)
1218, 1218 L 970.258 970.283 970.057-059 970.085 970.257 970.287 970.083 970.253 970.050 970.255 970.088 970.285 970.288 970.053 970.055 970.087	10.04-			3400 710 010 HD  3482 000 463  1878 023 831  3182 600 101	395 18 MF395 395GTZ HHIS-3	für Fahrzeuge mit Kupplungskraftverstärker / for vehicles with clutch booster (72) mit Sensor / with sensor (92) Füllmedium: Bremsflüssigkeit / Fill Medium: Brake Fluid (23)
1222 K 972.053 972.052	10.04-			3400 710 015  3482 000 464  1878 023 931  3182 600 166	395 18 MF395 395GTZ	mit Sensor / with sensor Füllmedium: Mineralöl / Fill Medium: Mineral Oil (92) (24)
1222, 1222 L 970.258 970.288 970.053 970.088 970.253 970.085 970.255 970.283 970.285 970.050 970.057/058 970.287 970.055 970.087 970.257 970.083	10.04-			3400 710 014 HD  3482 000 463  1878 023 831  3182 600 166	395 18 MF395 395GTZ	für Fahrzeuge mit Kupplungskraftverstärker / for vehicles with clutch booster (72) mit Sensor / with sensor (92) Füllmedium: Mineralöl / Fill Medium: Mineral Oil (24)
1223, 1223 L 970.285 970.053 970.059 970.085 970.258 970.055 970.287 970.253 970.257 970.283 970.288 970.087 970.255 970.057 970.083 970.088 970.050 970.058	01.98-10.04			3400 710 016  3482 000 464  1878 023 931  3182 600 141	395 18 MF395 395GTZ	ohne Sensor / without sensor Füllmedium: Mineralöl / Fill Medium: Mineral Oil (104) (24)
1223, 1223 L, 1224, 1224 L 970.087 970.258 970.257 970.283 970.057 970.255 970.285 970.287/288 970.059 970.053 970.050 970.058 970.253 970.085 970.088 970.055 970.083	10.04-			3400 710 017 HD  3482 000 463  1878 023 831  3182 600 141	395 18 MF395 395GTZ	für Fahrzeuge mit Kupplungskraftverstärker / for vehicles with clutch booster (72) ohne Sensor / without sensor (104) Füllmedium: Mineralöl / Fill Medium: Mineral Oil (24)
1224 K 972.052/053	10.04-	OM904, 906		3182 600 101	HHIS-3	mit Sensor / with sensor Füllmedium: Bremsflüssigkeit / Fill Medium: Brake Fluid (92) (23) Immer erneuern / Renew everytime (28)
1225 AF 976.353/354	01.98-10.04			3182 600 141		ohne Sensor / without sensor Füllmedium: Mineralöl / Fill Medium: Mineral Oil (104) (24) Immer erneuern / Renew everytime (28)
				3182 600 166		mit Sensor / with sensor Füllmedium: Mineralöl / Fill Medium: Mineral Oil (92) (24) Immer erneuern / Renew everytime (28)
				3182 998 501	HHIS-3	ohne Sensor / without sensor Füllmedium: Bremsflüssigkeit / Fill Medium: Brake Fluid (104) (23) Immer erneuern / Renew everytime (28)
				3151 000 396	KZIS-4	

		CODE				
--	--	------	--	---	---	---

MERCEDES-BENZ

ATEGO 1214 - 1229								
1225 F 976.053/054 1225 F 976.054 1226 F 976.053/054 1226, 1226 L 970.053 970.058/059 970.258 970.057 970.253 970.050 970.255 970.257 970.055	01.98-10.04	OM904		3400 127 701   3482 000 462  1878 052 842	362 18 MF362 362WGTB			
	10.04-			3400 700 484 HD   3482 000 462  1878 001 939	362 10 MF362 362WGTB			
	10.04-			3400 710 005  3482 000 462  1878 052 842  3182 998 501	362 18 MF362 362WGTB HHIS-3	ohne Sensor / without sensor Füllmedium: Bremsflüssigkeit / Fill Medium: Brake Fluid	(104) (23)	
					3400 710 008  3482 000 462  1878 052 842  3182 600 101	362 18 MF362 362WGTB HHIS-3	mit Sensor / with sensor Füllmedium: Bremsflüssigkeit / Fill Medium: Brake Fluid	(92) (23)
					3400 700 397  3482 000 463  1878 004 232	395 18 MF395 395WGTZ	für / for: SA 504672/22	(68)
			OM906		3400 121 201   3482 000 464  1878 023 931	395 18 MF395 395GTZ		
					3400 121 301 HD   3482 000 463  1878 023 831	395 18 MF395 395GTZ	für Fahrzeuge mit Kupplungskraftverstärker / for vehicles with clutch booster	(72)
					3400 710 006  3482 000 464  1878 023 931  3182 998 501	395 18 MF395 395GTZ HHIS-3	ohne Sensor / without sensor Füllmedium: Bremsflüssigkeit / Fill Medium: Brake Fluid	(104) (23)
					3400 710 007 HD  3482 000 463  1878 023 831  3182 998 501	395 18 MF395 395GTZ HHIS-3	für Fahrzeuge mit Kupplungskraftverstärker / for vehicles with clutch booster ohne Sensor / without sensor Füllmedium: Bremsflüssigkeit / Fill Medium: Brake Fluid	(72) (104) (23)
					3400 710 009  3482 000 464  1878 023 931  3182 600 101	395 18 MF395 395GTZ HHIS-3	mit Sensor / with sensor Füllmedium: Bremsflüssigkeit / Fill Medium: Brake Fluid	(92) (23)
					3400 710 010 HD  3482 000 463  1878 023 831  3182 600 101	395 18 MF395 395GTZ HHIS-3	für Fahrzeuge mit Kupplungskraftverstärker / for vehicles with clutch booster mit Sensor / with sensor Füllmedium: Bremsflüssigkeit / Fill Medium: Brake Fluid	(72) (92) (23)
					3400 710 015  3482 000 464  1878 023 931  3182 600 166	395 18 MF395 395GTZ	mit Sensor / with sensor Füllmedium: Mineralöl / Fill Medium: Mineral Oil	(92) (24)
					3400 710 014 HD  3482 000 463  1878 023 831  3182 600 166	395 18 MF395 395GTZ	für Fahrzeuge mit Kupplungskraftverstärker / for vehicles with clutch booster mit Sensor / with sensor Füllmedium: Mineralöl / Fill Medium: Mineral Oil	(72) (92) (24)
					3400 710 016  3482 000 464  1878 023 931  3182 600 141	395 18 MF395 395GTZ	ohne Sensor / without sensor Füllmedium: Mineralöl / Fill Medium: Mineral Oil	(104) (24)
					3400 710 017 HD  3482 000 463  1878 023 831  3182 600 141	395 18 MF395 395GTZ	für Fahrzeuge mit Kupplungskraftverstärker / for vehicles with clutch booster ohne Sensor / without sensor Füllmedium: Mineralöl / Fill Medium: Mineral Oil	(72) (104) (24)
			OM904, 906		3182 600 101	HHIS-3	mit Sensor / with sensor Füllmedium: Bremsflüssigkeit / Fill Medium: Brake Fluid Immer erneuern / Renew everytime	(92) (23) (28)
					3182 600 141		ohne Sensor / without sensor Füllmedium: Mineralöl / Fill Medium: Mineral Oil Immer erneuern / Renew everytime	(104) (24) (28)
					3182 600 166		mit Sensor / with sensor Füllmedium: Mineralöl / Fill Medium: Mineral Oil Immer erneuern / Renew everytime	(92) (24) (28)
					3182 998 501	HHIS-3	ohne Sensor / without sensor Füllmedium: Bremsflüssigkeit / Fill Medium: Brake Fluid Immer erneuern / Renew everytime	(104) (23) (28)
					3151 000 396	KZIS-4		



CODE



Parameter



















MERCEDES-BENZ

ATEGO 1214 - 1229

<p>1216 K 967.205 1216, 1216 L 967.008 967.025 967.028 967.005 1216, 1216 L 967.008 967.028 967.005 967.025 1218 K 967.205 1218, 1218 L 967.025 967.008 967.028 967.005 1218, 1218 L 967.008 967.028 967.025 967.005 1221 K 967.205 1221, 1221 L 967.028 967.005 967.008 967.025 1221, 1221 L 967.025 967.008 967.028 967.005 1223 AF 967.635 1223 F 967.605 1223 K 967.205 1223, 1223 L 967.008 967.028 967.005 967.025 1223, 1223 L 967.005 967.025 967.028 967.008 1224 K 967.205 1224, 1224 L 967.005 967.025 967.008 967.028 1224, 1224 L 967.025 967.028 967.005 967.008 1227 AF 967.635 1227 F 967.605 1227 K 967.205 1227, 1227 L 967.005 967.028 967.025 967.008 1227, 1227 L 967.005 967.025 967.008 967.028 1230 AF 967.635 1230 F 967.605 1230 K 967.205 1230, 1230 L 967.005 967.025 967.008 967.028</p>		OM934.911, OM934.913		6482 000 219	PHIS-5/34	Getr. / GBox: Powershift Abgasnorm: Euro 6 / Exhaust Emission Norm: Euro 6 Immer erneuern / Renew everytime	(4) (28)
---	--	-------------------------	--	---------------------	-----------	---	-------------

		CODE		 Parameter		
--	--	------	--	---	---	---



































































































MERCEDES-BENZ

ATEGO 1214 - 1229						
1230, 1230 L 967.028 967.008 967.005 967.025		OM934.911, OM934.913		6482 000 219	PHIS-5/34	Getr. / GBox: Powershift Abgasnorm: Euro 6 / Exhaust Emission Norm: Euro 6 Immer erneuern / Renew everytime (4) (28)
1228, 1228 L 970.253 970.257/258 970.057 970.050 970.053 970.058 970.255 970.055 970.059	01.98 - 10.04	OM906		3400 121 301   3482 000 463  1878 023 831	395 18 MF395 395GTZ	
1228, 1228 L, 1229, 1229 L 970.057 970.253 970.257 970.058 970.053 970.059 970.050 970.055 970.258 970.255	10.04 -			3400 710 007   3482 000 463  1878 023 831  3182 998 501	395 18 MF395 395GTZ HHIS-3	ohne Sensor / without sensor Füllmedium: Bremsflüssigkeit / Fill Medium: Brake Fluid (104) (23)
				3400 710 010   3482 000 463  1878 023 831  3182 600 101	395 18 MF395 395GTZ HHIS-3	mit Sensor / with sensor Füllmedium: Bremsflüssigkeit / Fill Medium: Brake Fluid (92) (23)
				3151 000 396	KZIS-4	

		CODE				
--	--	------	--	---	---	---

MERCEDES-BENZ

ATEGO 1315 - 1419

1317 A 970.362/363	01.98-10.04	OM904		3400 127 701   3482 000 462  1878 052 842	362 18 MF362 362WGTB		
1317 AK 972.362	01.98-10.04			3400 700 484 HD   3482 000 462  1878 001 939	362 10 MF362 362WGTB		
1317 K 972.062	01.98-10.04			  3482 000 462  1878 052 842	362 18 MF362 362WGTB	ohne Sensor / without sensor Füllmedium: Bremsflüssigkeit / Fill Medium: Brake Fluid	(104) (23)
1317 KO, 1317 LKO, 1318 KO, 1318 LKO 975.062 975.262	01.98-10.04			  3482 000 462  1878 052 842  3182 998 501	362 18 MF362 362WGTB HHIS-3	mit Sensor / with sensor Füllmedium: Bremsflüssigkeit / Fill Medium: Brake Fluid	(92) (23)
1317, 1317 L 970.060 970.063 970.068 970.065 970.067 970.268 970.267 970.263 970.265	01.98-10.04			  3482 000 462  1878 052 842  3182 600 101	362 18 MF362 362WGTB HHIS-3	mit Sensor / with sensor Füllmedium: Bremsflüssigkeit / Fill Medium: Brake Fluid	(92) (23)
1318 A 970.363 970.362	10.04-			3400 700 397  3482 000 463  1878 004 232	395 18 MF395 395WGTZ	für / for: SA 504672/22	(68)
1318 AK 972.362	10.04-			  3482 000 464  1878 023 931	395 18 MF395 395GTZ		
1318 K 972.062	10.04-	OM906		  3482 000 463  1878 023 831	395 18 MF395 395GTZ	für Fahrzeuge mit Kupplungskraftverstärker / for vehicles with clutch booster	(72)
1318 LKO 975.262	10.04-			  3482 000 464  1878 023 931  3182 998 501	395 18 MF395 395GTZ HHIS-3	ohne Sensor / without sensor Füllmedium: Bremsflüssigkeit / Fill Medium: Brake Fluid	(104) (23)
1318, 1318 L 970.067 970.060 970.063 970.267 970.265 970.065 970.068 970.263 970.268	10.04-			  3482 000 463  1878 023 831  3182 998 501	395 18 MF395 395GTZ HHIS-3	für Fahrzeuge mit Kupplungskraftverstärker / for vehicles with clutch booster ohne Sensor / without sensor Füllmedium: Bremsflüssigkeit / Fill Medium: Brake Fluid	(72) (104) (23)
1322 K 972.062	10.04-			  3482 000 463  1878 023 831  3182 998 501	395 18 MF395 395GTZ HHIS-3	mit Sensor / with sensor Füllmedium: Bremsflüssigkeit / Fill Medium: Brake Fluid	(92) (23)
1322 LS 974.262/263	10.04-			  3482 000 464  1878 023 931  3182 600 101	395 18 MF395 395GTZ HHIS-3	mit Sensor / with sensor Füllmedium: Bremsflüssigkeit / Fill Medium: Brake Fluid	(92) (23)
1322, 1322 L 970.268 970.267 970.263 970.059 970.067 970.265 970.068 970.063 970.060 970.065	10.04-			  3482 000 464  1878 023 931  3182 600 101	395 18 MF395 395GTZ HHIS-3	für Fahrzeuge mit Kupplungskraftverstärker / for vehicles with clutch booster mit Sensor / with sensor Füllmedium: Bremsflüssigkeit / Fill Medium: Brake Fluid	(72) (92) (23)
1323 A, 1324 A 970.363 970.362	10.04-			  3482 000 464  1878 023 831  3182 600 101	395 18 MF395 395GTZ HHIS-3	mit Sensor / with sensor Füllmedium: Bremsflüssigkeit / Fill Medium: Brake Fluid	(92) (23)
1323 KO, 1323 LKO 975.062 975.262	01.98-10.04			  3482 000 464  1878 023 931  3182 600 166	395 18 MF395 395GTZ	mit Sensor / with sensor Füllmedium: Mineralöl / Fill Medium: Mineral Oil	(92) (24)
1323 LS 974.262/263	01.98-10.04			  3482 000 463  1878 023 831  3182 600 166	395 18 MF395 395GTZ	für Fahrzeuge mit Kupplungskraftverstärker / for vehicles with clutch booster mit Sensor / with sensor Füllmedium: Mineralöl / Fill Medium: Mineral Oil	(72) (92) (24)
1323 LS, 1324 LS 974.262/263	10.04-			  3482 000 463  1878 023 831  3182 600 166	395 18 MF395 395GTZ	ohne Sensor / without sensor Füllmedium: Mineralöl / Fill Medium: Mineral Oil	(104) (24)
1323, 1323 L 970.268 970.263 970.065 970.267 970.068 970.063 970.265 970.067	01.98-10.04			  3482 000 464  1878 023 931  3182 600 141	395 18 MF395 395GTZ	ohne Sensor / without sensor Füllmedium: Mineralöl / Fill Medium: Mineral Oil	(104) (24)
1323, 1323 L, 1324, 1324 L 970.268 970.067 970.263 970.265 970.068 970.063 970.267 970.065	10.04-			  3482 000 463  1878 023 831  3182 600 141	395 18 MF395 395GTZ	für Fahrzeuge mit Kupplungskraftverstärker / for vehicles with clutch booster ohne Sensor / without sensor Füllmedium: Mineralöl / Fill Medium: Mineral Oil	(72) (104) (24)
1324 AK 972.372 972.362	10.04-			  3482 000 463  1878 023 831  3182 600 141	395 18 MF395 395GTZ	mit Sensor / with sensor Füllmedium: Mineralöl / Fill Medium: Mineral Oil	(92) (24)
1324 K 972.062	10.04-	OM904, 906		3182 600 101	HHIS-3	mit Sensor / with sensor Füllmedium: Bremsflüssigkeit / Fill Medium: Brake Fluid Immer erneuern / Renew everytime	(92) (23) (28)
1325 AF 976.364 976.363	01.98-10.04			3182 600 141		ohne Sensor / without sensor Füllmedium: Mineralöl / Fill Medium: Mineral Oil Immer erneuern / Renew everytime	(104) (24) (28)
1325 F 976.065 976.063/064	01.98-10.04			3182 600 166		mit Sensor / with sensor Füllmedium: Mineralöl / Fill Medium: Mineral Oil Immer erneuern / Renew everytime	(92) (24) (28)
1326 F 976.063 976.065 976.064	10.04-			3182 998 501	HHIS-3	ohne Sensor / without sensor Füllmedium: Bremsflüssigkeit / Fill Medium: Brake Fluid Immer erneuern / Renew everytime	(104) (23) (28)
1326 LS 974.262/263	10.04-			3151 000 396	KZIS-4		
1326, 1326 L 970.268 970.067 970.063 970.068 970.263 970.267 970.265 970.065	10.04-						



CODE



Parameter















MERCEDES-BENZ

ATEGO 1315 - 1419

<p>1318 A 967.036 1318 AK 967.236 1318 K 967.206 1318 LKO 967.526 1318, 1318 L 967.026 967.006 1321 A 967.036 1321 AK 967.236 1321 K 967.206 1321 LKO 967.526 1321 LS 967.426 1321, 1321 L 967.006 967.026 1323 A 967.036 1323 AF 967.636 1323 AK 967.236 1323 F 967.606 1323 K 967.206 1323 LKO 967.526 1323 LS 967.426 1323, 1323 L 967.026 967.006 1324 A 967.036 1324 AK 967.236 1324 K 967.206 1324 LKO 967.526 1324 LS 967.426 1324, 1324 L 967.026 967.006 1327 AF 967.636 1327 AK 967.236 1327 F 967.606 1327 K 967.206 1327 LS 967.426 1327, 1327 L 967.026 967.006 1330 AF 967.636 1330 AK 967.236</p>		<p>OM934.911, OM934.913</p>		<p>6482 000 219</p>	<p>PHIS-5/34</p>	<p>Getr. / GBox: Powershift Abgasnorm: Euro 6 / Exhaust Emission Norm: Euro 6 Immer erneuern / Renew everytime</p>	<p>(4) (28)</p>
---	--	---------------------------------	---	----------------------------	------------------	--	---------------------











































































		CODE		 Parameter		
--	--	------	--	---	---	---

MERCEDES-BENZ

ATEGO 1315 - 1419							
1330 F 967.606 1330 K 967.206 1330 LS 967.426 1330, 1330 L 967.006 967.026		OM934.911, OM934.913		6482 000 219	PHIS-5/34	Getr. / GBox: Powershift Abgasnorm: Euro 6 / Exhaust Emission Norm: Euro 6 Immer erneuern / Renew everytime	(4) (28)
1328 AF 976.363/364 1328 F 976.063-065 1328 LS 974.263 974.262 1328 LS, 1329 LS 974.263 974.262 1328, 1328 L 970.065 970.063 970.267 970.265 970.263 970.067/068 970.268 1328, 1328 L, 1329, 1329 L 970.063 970.263 970.065 970.265 970.068 970.267/268 970.067 1329 F 976.064/065 976.063	01.98 - 10.04 01.98 - 10.04 01.98 - 10.04 10.04 - 01.98 - 10.04 10.04 - 10.04 -	OM906	   	3400 121 301   3482 000 463  1878 023 831	395 18 MF395 395GTZ	ohne Sensor / without sensor Füllmedium: Bremsflüssigkeit / Fill Medium: Brake Fluid	(104) (23)
				3400 710 007  3482 000 463  1878 023 831  3182 998 501	395 18 MF395 395GTZ HHIS-3	mit Sensor / with sensor Füllmedium: Bremsflüssigkeit / Fill Medium: Brake Fluid	(92) (23)
				 3151 000 396	KZIS-4		





		CODE				
--	--	------	--	---	---	---

MERCEDES-BENZ

ATEGO 1517 - 1728							
1517 A 970.373	01.98-10.04	OM904		3400 127 701   3482 000 462  1878 052 842	362 18 MF362 362WGTB		
	01.98-10.04			3400 700 484 HD   3482 000 462  1878 001 939	362 10 MF362 362WGTB		
1517, 1517 L 375.121/122 970.273 970.078 970.077 970.277 970.075 970.275 970.278 970.073	01.98-10.04	OM904		3400 710 005   3482 000 462  1878 052 842  3182 998 501	362 18 MF362 362WGTB HHIS-3	ohne Sensor / without sensor Füllmedium: Bremsflüssigkeit / Fill Medium: Brake Fluid	(104) (23)
	10.04-			3400 710 008   3482 000 462  1878 052 842  3182 600 101	362 18 MF362 362WGTB HHIS-3	mit Sensor / with sensor Füllmedium: Bremsflüssigkeit / Fill Medium: Brake Fluid	(92) (23)
1518 A 970.373	10.04-	OM904		3400 700 397   3482 000 463  1878 004 232	395 18 MF395 395WGTZ	für / for: SA 504672/22	(68)
1518 K 972.072	10.04-		OM906		3400 121 201   3482 000 464  1878 023 931	395 18 MF395 395GTZ	
1518, 1518 L 970.278 970.075 970.078 958.054 970.273 970.277 958.052 958.056 958.050 970.275 970.073 970.077	10.04-	OM906			3400 121 301 HD   3482 000 463  1878 023 831	395 18 MF395 395GTZ	für Fahrzeuge mit Kupplungskraftverstärker / for vehicles with clutch booster
1522 K 972.072	10.04-		OM906		3400 710 006   3482 000 464  1878 023 931  3182 998 501	395 18 MF395 395GTZ HHIS-3	ohne Sensor / without sensor Füllmedium: Bremsflüssigkeit / Fill Medium: Brake Fluid
1522, 1522 L 970.077 970.273 970.278 970.075 970.078 970.277 970.073 970.275	10.04-	OM906			3400 710 007 HD   3482 000 463  1878 023 831  3182 998 501	395 18 MF395 395GTZ HHIS-3	für Fahrzeuge mit Kupplungskraftverstärker / for vehicles with clutch booster ohne Sensor / without sensor Füllmedium: Bremsflüssigkeit / Fill Medium: Brake Fluid
1523 A 970.373	01.98-10.04		OM906		3400 710 009   3482 000 464  1878 023 931  3182 600 101	395 18 MF395 395GTZ HHIS-3	mit Sensor / with sensor Füllmedium: Bremsflüssigkeit / Fill Medium: Brake Fluid
1523 A, 1524 A 970.372/373	10.04-	OM906			3400 710 010 HD   3482 000 463  1878 023 831  3182 600 101	395 18 MF395 395GTZ HHIS-3	für Fahrzeuge mit Kupplungskraftverstärker / for vehicles with clutch booster mit Sensor / with sensor Füllmedium: Bremsflüssigkeit / Fill Medium: Brake Fluid
1523 AK 972.372	01.98-10.04		OM906		3400 710 015   3482 000 464  1878 023 931  3182 600 166	395 18 MF395 395GTZ	mit Sensor / with sensor Füllmedium: Mineralöl / Fill Medium: Mineral Oil
1523 K 972.072	10.04-	OM906			3400 710 014 HD   3482 000 463  1878 023 831  3182 600 166	395 18 MF395 395GTZ	für Fahrzeuge mit Kupplungskraftverstärker / for vehicles with clutch booster mit Sensor / with sensor Füllmedium: Mineralöl / Fill Medium: Mineral Oil
1523 KO 975.072	01.98-10.04		OM906		3400 710 016   3482 000 464  1878 023 931  3182 600 141	395 18 MF395 395GTZ	ohne Sensor / without sensor Füllmedium: Mineralöl / Fill Medium: Mineral Oil
1523, 1523 L 970.273 970.078 970.075 970.275 970.277 970.077 970.073 970.278	01.98-10.04	OM906			3400 710 017 HD   3482 000 463  1878 023 831  3182 600 141	395 18 MF395 395GTZ	für Fahrzeuge mit Kupplungskraftverstärker / for vehicles with clutch booster ohne Sensor / without sensor Füllmedium: Mineralöl / Fill Medium: Mineral Oil
1524 AK 972.362 972.372	10.04-		OM904, 906		3182 600 101	HHIS-3	mit Sensor / with sensor Füllmedium: Bremsflüssigkeit / Fill Medium: Brake Fluid Immer erneuern / Renew everytime
1524 AF 976.373/374	01.98-10.04	OM904, 906			3182 600 141		ohne Sensor / without sensor Füllmedium: Mineralöl / Fill Medium: Mineral Oil Immer erneuern / Renew everytime
1526 AK 972.372	10.04-		OM904, 906		3182 600 166		mit Sensor / with sensor Füllmedium: Mineralöl / Fill Medium: Mineral Oil Immer erneuern / Renew everytime
1526 K 972.072	10.04-	OM904, 906			3182 998 501	HHIS-3	ohne Sensor / without sensor Füllmedium: Bremsflüssigkeit / Fill Medium: Brake Fluid Immer erneuern / Renew everytime
1526, 1526 L 970.073 970.075 970.278 970.273 970.078 970.275 970.277 970.077	10.04-		OM904, 906		3151 000 396	KZIS-4	
1725 A 958.078	10.06-						



































































		CODE				
--	--	------	--	---	---	---

MERCEDES-BENZ

ATEGO 1517 - 1728							
1518 A 967.037 1518 K 967.207 1518, 1518 L 967.007 967.027 1521 A 967.037 1521 AK 967.237 1521 K 967.207 1521, 1521 L 967.027 967.007 1523 A 967.037 1523 AK 967.237 1523 K 967.207 1523, 1523 L 967.027 967.007 1524 A 967.037 1524 AK 967.237 1524 K 967.207 1524, 1524 L 967.027 967.007 1527 AF 967.637 1527 AK 967.237 1527 F 967.607 1527 K 967.207 1527, 1527 L 967.027 967.007 1530 AF 967.637 1530 AK 967.237 1530 F 967.607 1530 K 967.207 1530, 1530 L 967.007 967.027		OM934.913, OM934.911		6482 000 219	PHIS-5/34	Getr. / GBox: Powershift Abgasnorm: Euro 6 / Exhaust Emission Norm: Euro 6 Immer erneuern / Renew everytime	(4) (28)
1528 AF 976.374 976.373 1528 F 976.075 976.077 1528, 1528 L 970.277 970.273 970.078 970.077 970.275 970.075 970.278 970.073 1528, 1528 L, 1529, 1529 L 970.078 970.273 970.277 970.077 970.075 970.278 970.275 970.073 1529 AK 972.372 1529 K 972.072	01.98 - 10.04 01.98 - 10.04 01.98 - 10.04 10.04 - 10.04 - 10.04 -	OM906	   	3400 121 301 3482 000 463 1878 023 831 3400 710 007 3482 000 463 1878 023 831 3182 998 501 3400 710 010 3482 000 463 1878 023 831 3182 600 101 3151 000 396	395 18 MF395 395GTZ 395 18 MF395 395GTZ HHIS-3 395 18 MF395 395GTZ HHIS-3 KZIS-4	ohne Sensor / without sensor Füllmedium: Bremsflüssigkeit / Fill Medium: Brake Fluid mit Sensor / with sensor Füllmedium: Bremsflüssigkeit / Fill Medium: Brake Fluid	(104) (23) (92) (23)













































		CODE				
--	--	------	--	---	---	---

MERCEDES-BENZ

ATEGO 1823 - 1929							
1823 AK 952.563 952.562 1823 K 952.502/503 1823 LS 954.532	04.98 - 10.04	OM906LA		3400 121 201   3482 000 464  1878 023 931	395 18 MF395 395GTZ		
	04.98 - 10.04			3400 121 301 HD   3482 000 463  1878 023 831	395 18 MF395 395GTZ	für Fahrzeuge mit Kupplungskraftverstärker / for vehicles with clutch booster (72)	
	04.98 - 10.04			3400 710 006  3482 000 464  1878 023 931  3182 998 501	395 18 MF395 395GTZ HHIS-3	ohne Sensor / without sensor Füllmedium: Bremsflüssigkeit / Fill Medium: Brake Fluid (104) (23)	
					3400 710 007 HD  3482 000 463  1878 023 831  3182 998 501	395 18 MF395 395GTZ HHIS-3	für Fahrzeuge mit Kupplungskraftverstärker / for vehicles with clutch booster ohne Sensor / without sensor Füllmedium: Bremsflüssigkeit / Fill Medium: Brake Fluid (72) (104) (23)
					3400 710 009  3482 000 464  1878 023 931  3182 600 101	395 18 MF395 395GTZ HHIS-3	mit Sensor / with sensor Füllmedium: Bremsflüssigkeit / Fill Medium: Brake Fluid (92) (23)
					3400 710 010 HD  3482 000 463  1878 023 831  3182 600 101	395 18 MF395 395GTZ HHIS-3	für Fahrzeuge mit Kupplungskraftverstärker / for vehicles with clutch booster mit Sensor / with sensor Füllmedium: Bremsflüssigkeit / Fill Medium: Brake Fluid (72) (92) (23)
					3400 700 414   3483 030 031  1878 002 732	430 18 MFZ430 430WGTZ	für / for: SA504682-09 (68)
					3483 030 031  MFZ430	430	für / for: SA504682-09 (68)
					1878 002 731	430 18 430GTZ	für / for: SA504682-09 (68)
					3483 000 139  GMFZ430N	430	für / for: SA504682-10 für Nebenantrieb / for PTO nicht in Verbindung mit Austausch-Kupplungsscheibe / not in connection with replacement clutch disc (68) (82) (99)
					1878 002 732	430 18 430WGTZ	für / for: SA504682-10 für Nebenantrieb / for PTO (68) (82)
			OM906		3151 000 396	KZIS-4	für OE-Nummer / for OE number 001 250 99 15 für OE-Nummer / for OE number 002 250 00 15 (83) (83)
	1823, 1823 L 950.503 950.509 950.536 950.501 950.532 950.535 950.538/539 950.531 950.533 950.508 950.546 950.502 950.506/507 950.505 950.534 950.547 950.504 950.537 950.544	01.98 - 10.04	OM906LA		3400 121 201   3482 000 464  1878 023 931	395 18 MF395 395GTZ	
				3400 121 301 HD   3482 000 463  1878 023 831	395 18 MF395 395GTZ	für Fahrzeuge mit Kupplungskraftverstärker / for vehicles with clutch booster (72)	
				3400 710 006  3482 000 464  1878 023 931  3182 998 501	395 18 MF395 395GTZ HHIS-3	ohne Sensor / without sensor Füllmedium: Bremsflüssigkeit / Fill Medium: Brake Fluid (104) (23)	
					3400 710 007 HD  3482 000 463  1878 023 831  3182 998 501	395 18 MF395 395GTZ HHIS-3	für Fahrzeuge mit Kupplungskraftverstärker / for vehicles with clutch booster ohne Sensor / without sensor Füllmedium: Bremsflüssigkeit / Fill Medium: Brake Fluid (72) (104) (23)
					3400 710 009  3482 000 464  1878 023 931  3182 600 101	395 18 MF395 395GTZ HHIS-3	mit Sensor / with sensor Füllmedium: Bremsflüssigkeit / Fill Medium: Brake Fluid (92) (23)
					3400 710 010 HD  3482 000 463  1878 023 831  3182 600 101	395 18 MF395 395GTZ HHIS-3	für Fahrzeuge mit Kupplungskraftverstärker / for vehicles with clutch booster mit Sensor / with sensor Füllmedium: Bremsflüssigkeit / Fill Medium: Brake Fluid (72) (92) (23)
					3483 030 031  MFZ430	430	für / for: SA504682-09 (68)
					1878 002 731	430 18 430GTZ	für / for: SA504682-09 (68)
					3483 000 139  GMFZ430N	430	für / for: SA504682-10 für Nebenantrieb / for PTO nicht in Verbindung mit Austausch-Kupplungsscheibe / not in connection with replacement clutch disc (68) (82) (99)
					1878 002 732	430 18 430WGTZ	für / for: SA504682-10 für Nebenantrieb / for PTO (68) (82)
			OM906		3151 000 396	KZIS-4	für OE-Nummer / for OE number 001 250 99 15 für OE-Nummer / for OE number 002 250 00 15 (83) (83)

























		CODE				
--	--	------	--	---	---	---





















MERCEDES-BENZ

ATEGO 1823 - 1929									
1828 A 950.563 950.562 1828 AK 952.563 952.562 1828 K 952.502/503 1828 LS 954.532	04.98 - 10.04	OM906LA		3400 121 301 ◐  3482 000 463  1878 023 831	395 18 MF395 395GTZ				
				3400 710 007  3482 000 463  1878 023 831  3182 998 501	395 18 MF395 395GTZ HHIS-3	ohne Sensor / without sensor Füllmedium: Bremsflüssigkeit / Fill Medium: Brake Fluid	(104) (23)		
				3400 710 010  3482 000 463  1878 023 831  3182 600 101	395 18 MF395 395GTZ HHIS-3	mit Sensor / with sensor Füllmedium: Bremsflüssigkeit / Fill Medium: Brake Fluid	(92) (23)		
				3400 700 414 ⊕  3483 030 031  1878 002 732	430 18 MFZ430 430WGTZ	für / for: SA504682-09	(68)		
				3483 030 031 ⊕ 	430 MFZ430	für / for: SA504682-09	(68)		
				1878 002 731 	430 18 430GTZ	für / for: SA504682-09	(68)		
				3483 000 139 ⊕ 	430 GMFZ430N	für / for: SA504682-10 für Nebenantrieb / for PTO nicht in Verbindung mit Austausch-Kupplungsscheibe / not in connection with replacement clutch disc	(68) (82) (99)		
				1878 002 732 	430 18 430WGTZ	für / for: SA504682-10 für Nebenantrieb / for PTO	(68) (82)		
					OM906		3151 000 396 	KZIS-4 für OE-Nummer / for OE number 001 250 99 15 für OE-Nummer / for OE number 002 250 00 15	(83) (83)
			1828, 1828 L 950.504 950.532/533 950.537 950.531 950.547 950.535 950.534 950.501 950.507 950.536 950.546 950.503 950.538 950.544 950.502 950.506 950.505 950.508	04.98 - 10.04	OM906LA		3400 121 301 ◐  3482 000 463  1878 023 831	395 18 MF395 395GTZ	
	3400 710 007  3482 000 463  1878 023 831  3182 998 501	395 18 MF395 395GTZ HHIS-3				ohne Sensor / without sensor Füllmedium: Bremsflüssigkeit / Fill Medium: Brake Fluid	(104) (23)		
	3400 710 010  3482 000 463  1878 023 831  3182 600 101	395 18 MF395 395GTZ HHIS-3				mit Sensor / with sensor Füllmedium: Bremsflüssigkeit / Fill Medium: Brake Fluid	(92) (23)		
	3483 030 031 ⊕ 	430 MFZ430				für / for: SA504682-09	(68)		
	1878 002 731 	430 18 430GTZ				für / for: SA504682-09	(68)		
	3483 000 139 ⊕ 	430 GMFZ430N				für / for: SA504682-10 für Nebenantrieb / for PTO nicht in Verbindung mit Austausch-Kupplungsscheibe / not in connection with replacement clutch disc	(68) (82) (99)		
	1878 002 732 	430 18 430WGTZ				für / for: SA504682-10 für Nebenantrieb / for PTO	(68) (82)		
		OM906					3151 000 396 	KZIS-4 für OE-Nummer / for OE number 001 250 99 15 für OE-Nummer / for OE number 002 250 00 15	(83) (83)

		CODE				
--	--	------	--	---	---	---























MERCEDES-BENZ



























ATEGO 2223 - 2530								
2223 L 970.675 970.677 970.673 2228 L 970.673 970.675 970.677 2523 L 950.624 2528 L 950.613 950.603 950.605 950.624 950.626 950.604 950.625 950.602 950.623 950.614	04.98 - 10.04	OM906LA		3400 121 301   3482 000 463  1878 023 831	395 18 MF395 395GTZ			
	04.98 - 10.04			3400 710 007  3482 000 463  1878 023 831  3182 998 501	395 18 MF395 395GTZ HHIS-3	ohne Sensor / without sensor Füllmedium: Bremsflüssigkeit / Fill Medium: Brake Fluid	(104) (23)	
	04.98 - 10.04			3400 710 010  3482 000 463  1878 023 831  3182 600 101	395 18 MF395 395GTZ HHIS-3	mit Sensor / with sensor Füllmedium: Bremsflüssigkeit / Fill Medium: Brake Fluid	(92) (23)	
					3400 700 414   3483 030 031  1878 002 732	430 18 MFZ430 430WGTZ	für / for: SA504682-09	(68)
					3483 030 031  	430 MFZ430	für / for: SA504682-09	(68)
					1878 002 731	430 18 430GTZ	für / for: SA504682-09	(68)
					3483 000 139  	430 GMFZ430N	für / for: SA504682-10 für Nebenantrieb / for PTO nicht in Verbindung mit Austausch-Kupplungsscheibe / not in connection with replacement clutch disc	(68) (82) (99)
					1878 002 732	430 18 430WGTZ	für / for: SA504682-10 für Nebenantrieb / for PTO	(68) (82)
			OM906		3151 000 396	KZIS-4	für OE-Nummer / for OE number 001 250 99 15 für OE-Nummer / for OE number 002 250 00 15	(83) (83)

ATEGO 2628 -								
2628 950.642/643 2628 K 952.641-643	04.98 - 10.04	OM906LA		3400 121 301   3482 000 463  1878 023 831	395 18 MF395 395GTZ			
	04.98 - 10.04			3400 710 007  3482 000 463  1878 023 831  3182 998 501	395 18 MF395 395GTZ HHIS-3	ohne Sensor / without sensor Füllmedium: Bremsflüssigkeit / Fill Medium: Brake Fluid	(104) (23)	
					3400 710 010  3482 000 463  1878 023 831  3182 600 101	395 18 MF395 395GTZ HHIS-3	mit Sensor / with sensor Füllmedium: Bremsflüssigkeit / Fill Medium: Brake Fluid	(92) (23)
					3483 030 031  	430 MFZ430	für / for: SA504682-09	(68)
					1878 002 731	430 18 430GTZ	für / for: SA504682-09	(68)
					3483 000 139  	430 GMFZ430N	für / for: SA504682-10 für Nebenantrieb / for PTO nicht in Verbindung mit Austausch-Kupplungsscheibe / not in connection with replacement clutch disc	(68) (82) (99)
					1878 002 732	430 18 430WGTZ	für / for: SA504682-10 für Nebenantrieb / for PTO	(68) (82)
			OM906		3151 000 396	KZIS-4	für OE-Nummer / for OE number 001 250 99 15 für OE-Nummer / for OE number 002 250 00 15	(83) (83)

		CODE				
--	--	------	--	---	---	---







































































MERCEDES-BENZ

ATEGO 2628 -							
2628 B 953.643 953.641	04.98 - 10.04	OM906LA		3400 121 301   3482 000 463  1878 023 831	395 18 MF395 395GTZ		
				3400 710 007  3482 000 463  1878 023 831  3182 998 501	395 18 MF395 395GTZ HHIS-3	ohne Sensor / without sensor Füllmedium: Bremsflüssigkeit / Fill Medium: Brake Fluid	(104) (23)
				3400 710 010  3482 000 463  1878 023 831  3182 600 101	395 18 MF395 395GTZ HHIS-3	mit Sensor / with sensor Füllmedium: Bremsflüssigkeit / Fill Medium: Brake Fluid	(92) (23)
				3483 030 031 	430 MFZ430	für / for: SA504682-09	(68)
				1878 002 731	430 18 430GTZ	für / for: SA504682-09	(68)
				3483 000 139 	430 GMFZ430N	für / for: SA504682-10 für Nebenantrieb / for PTO nicht in Verbindung mit Austausch-Kupplungsscheibe / not in connection with replacement clutch disc	(68) (82) (99)
				1878 002 732	430 18 430WGTZ	für / for: SA504682-10 für Nebenantrieb / for PTO	(68) (82)
				OM906		3151 000 396	KZIS-4
	OM926		3400 700 446   3483 000 258  1878 005 165	430 18 MFZ430 430WGTZ			

AXOR 1823 - 2044		01.02 -						
1823 375.301 1823 K 375.303	01.02 - 10.04	OM906.920		3400 121 201   3482 000 464  1878 023 931	395 18 MF395 395GTZ	für / for: SA531129-01	(68)	
	01.02 - 10.04			3400 121 301   3482 000 463  1878 023 831	395 18 MF395 395GTZ	für / for: SA531129-02	(68)	
				3400 710 006  3482 000 464  1878 023 931  3182 998 501	395 18 MF395 395GTZ HHIS-3	ohne Sensor / without sensor Füllmedium: Bremsflüssigkeit / Fill Medium: Brake Fluid	(104) (23)	
				3400 710 007  3482 000 463  1878 023 831  3182 998 501	395 18 MF395 395GTZ HHIS-3	ohne Sensor / without sensor Füllmedium: Bremsflüssigkeit / Fill Medium: Brake Fluid	(104) (23)	
				3400 710 009  3482 000 464  1878 023 931  3182 600 101	395 18 MF395 395GTZ HHIS-3	mit Sensor / with sensor Füllmedium: Bremsflüssigkeit / Fill Medium: Brake Fluid	(92) (23)	
				3400 710 010  3482 000 463  1878 023 831  3182 600 101	395 18 MF395 395GTZ HHIS-3	mit Sensor / with sensor Füllmedium: Bremsflüssigkeit / Fill Medium: Brake Fluid	(92) (23)	
					3182 998 501	HHIS-3	für / for: SA504673-06/10 für / for: SA504673-07/22 ohne Sensor / without sensor Füllmedium: Bremsflüssigkeit / Fill Medium: Brake Fluid Immer erneuern / Renew everytime	(68) (68) (104) (23) (28)
					3182 600 101	HHIS-3	für / for: SA504673-08/11 mit Sensor / with sensor Füllmedium: Bremsflüssigkeit / Fill Medium: Brake Fluid Immer erneuern / Renew everytime	(68) (92) (23) (28)











		CODE				
--	--	------	--	---	---	---





MERCEDES-BENZ

AXOR 1823 - 2044		01.02 -					
1823, 1823 L, 1824, 1824 L, LL 950.532 950.536 950.531 950.538 950.503 950.533 950.539 950.507 950.509 950.547 950.502 950.535 950.546 950.544 950.537 950.501 950.505/506 950.534 950.504 950.508 1823 AK, 1824 AK 952.562/563 1823 LS, 1824 LS 954.532 1823 K, 1823 KL, 1824 K 952.502/503 1826, 1826 L, LL 950.503/504 950.534 950.506 950.535 950.537 950.533 950.546/547 950.509 950.508 950.532 950.538 950.531 950.539 950.502 950.544 950.536 950.501 950.505 950.507 1826 AK 952.562/563 1826 K 952.502/503 1826 LS 954.532 1828, 1828 L, 1829, 1829 L, LL 950.502/503 950.508 950.544 950.501 950.506 950.532 950.538/539 950.509 950.537 950.536 950.505 950.533 950.547 950.531 950.546 950.535 950.504 950.507 950.534 1828 A, 1829 A 950.562/563 1828 AK, 1829 AK 952.562 374.557 952.563 1828 K, 1828 KL, 1829 K 952.503 952.502 374.554 1829 LS 954.532 1833, 1833 L, LL 950.503 950.509 950.534 950.538/539 950.502 950.505 950.535 950.531 950.501 950.508 950.547 950.506/507 950.532 950.537 950.544 950.504 950.546 950.536 950.533 1833 A 950.563 950.562 1833 AK 952.563 952.562 1833 K 952.503 952.502 1833 LS 954.532	10.04-	OM906LA	 3400 121 201   3482 000 464  1878 023 931	395 18 MF395 395GTZ	max. übertragbares Motormoment [Nm] / max. transmittable engine torque [Nm]: 810	(87)	
				 3400 121 301   3482 000 463  1878 023 831	395 18 MF395 395GTZ	max. übertragbares Motormoment [Nm] / max. transmittable engine torque [Nm]: 900	(87)
				 3400 710 009   3482 000 464  1878 023 931  3182 600 101	395 18 MF395 395GTZ HHIS-3	mit Sensor / with sensor max. übertragbares Motormoment [Nm] / max. transmittable engine torque [Nm]: 810 Füllmedium: Bremsflüssigkeit / Fill Medium: Brake Fluid	(92) (87)
		10.04-		 3400 710 006   3482 000 464  1878 023 931  3182 998 501	395 18 MF395 395GTZ HHIS-3	ohne Sensor / without sensor max. übertragbares Motormoment [Nm] / max. transmittable engine torque [Nm]: 810 Füllmedium: Bremsflüssigkeit / Fill Medium: Brake Fluid	(104) (87)
		10.04-		 3400 710 010   3482 000 463  1878 023 831  3182 600 101	395 18 MF395 395GTZ HHIS-3	mit Sensor / with sensor max. übertragbares Motormoment [Nm] / max. transmittable engine torque [Nm]: 900 Füllmedium: Bremsflüssigkeit / Fill Medium: Brake Fluid	(92) (87) (23)
				 3400 710 007   3482 000 463  1878 023 831  3182 998 501	395 18 MF395 395GTZ HHIS-3	ohne Sensor / without sensor max. übertragbares Motormoment [Nm] / max. transmittable engine torque [Nm]: 900 Füllmedium: Bremsflüssigkeit / Fill Medium: Brake Fluid	(104) (87) (23)
		10.04-		 3400 710 012   3482 000 464  1878 023 931  3182 600 172	395 18 MF395 395GTZ	für / for: SA504673/30 Kabellänge [mm] / Cable Length [mm]: 220 mit Sensor / with sensor max. übertragbares Motormoment [Nm] / max. transmittable engine torque [Nm]: 810 Füllmedium: Mineralöl / Fill Medium: Mineral Oil	(68) (34) (92) (87)
		10.04-		 3400 710 013   3482 000 463  1878 023 831  3182 600 172	395 18 MF395 395GTZ	für / for: SA504673/30 Kabellänge [mm] / Cable Length [mm]: 220 mit Sensor / with sensor max. übertragbares Motormoment [Nm] / max. transmittable engine torque [Nm]: 900 Füllmedium: Mineralöl / Fill Medium: Mineral Oil	(68) (34) (92) (87)
				 3400 710 015   3482 000 464  1878 023 931  3182 600 166	395 18 MF395 395GTZ	mit Sensor / with sensor max. übertragbares Motormoment [Nm] / max. transmittable engine torque [Nm]: 810 Füllmedium: Mineralöl / Fill Medium: Mineral Oil	(92) (87) (24)
		10.04-		 3400 710 014   3482 000 463  1878 023 831  3182 600 166	395 18 MF395 395GTZ	mit Sensor / with sensor max. übertragbares Motormoment [Nm] / max. transmittable engine torque [Nm]: 900 Füllmedium: Mineralöl / Fill Medium: Mineral Oil	(92) (87) (24)
		10.04-		 3400 710 016   3482 000 464  1878 023 931  3182 600 141	395 18 MF395 395GTZ	ohne Sensor / without sensor max. übertragbares Motormoment [Nm] / max. transmittable engine torque [Nm]: 810 Füllmedium: Mineralöl / Fill Medium: Mineral Oil	(104) (87) (24)
		10.04-		 3400 710 017   3482 000 463  1878 023 831  3182 600 141	395 18 MF395 395GTZ	ohne Sensor / without sensor max. übertragbares Motormoment [Nm] / max. transmittable engine torque [Nm]: 900 Füllmedium: Mineralöl / Fill Medium: Mineral Oil	(104) (87) (24)
				 3400 700 414  HD+  3483 030 031  1878 002 732	430 18 MFZ430 430WGTZ		
				 3483 000 139 	430 GMFZ430N	für Nebenantrieb / for PTO nicht in Verbindung mit Austausch-Kupplungsscheibe / not in connection with replacement clutch disc	(82) (99)
		10.04-		 1878 002 731	430 18 430GTZ	für Nebenantrieb / for PTO	(82)
		10.04-	OM926LA	 3400 700 446    3483 000 258  1878 005 165	430 18 MFZ430 430WGTZ		

		CODE				
--	--	------	--	---	---	---







































MERCEDES-BENZ

AXOR 1823 - 2044		01.02 -					
1835 LS 944.032 375.408 944.033 1836 LS, LLS 944.032/033 1840 LS 944.033 944.032 375.408 1843 LS 944.032/033 375.408 1843 LS, LLS 944.032/033	01.02 - 10.04	OM457.980, OM457.948, OM457.937	 3400 122 801 ⊕ ⊗ 3483 030 032 ⊗ 1878 005 165	430 18 MFZ430 430WGTZ	für / for: SA 531129-04/05	(68)	
	10.04 -		 3400 700 446 ⊕ ⊗ 3483 000 258 ⊗ 1878 005 165	430 18 MFZ430 430WGTZ	für / for: SA 504682-24	(68)	
	01.02 - 10.04		 3182 998 501	HHIS-3	Getr. / GBox: 9-Gang/gear 715.561 ohne Sensor / without sensor Füllmedium: Bremsflüssigkeit / Fill Medium: Brake Fluid Immer erneuern / Renew everytime	(104) (23) (28)	
	01.02 - 10.04		 1863 869 028				
1840 LS, LLS 944.033 374.651 944.032	10.04 -	OM457.980, OM457.955, OM457.948, OM457.937	 3400 122 801 ⊕ ⊗ 3483 030 032 ⊗ 1878 005 165	430 18 MFZ430 430WGTZ	für / for: SA 531129-04/05	(68)	
			 3400 700 446 ⊕ ⊗ 3483 000 258 ⊗ 1878 005 165	430 18 MFZ430 430WGTZ	für / for: SA 504682-24	(68)	
			 3483 000 461 ⊕	430 MFZ430	für / for: SA 591014/07	(68)	
			 1878 005 165	430 18 430WGTZ	für / for: SA 591014/07	(68)	
			 3182 998 501	HHIS-3	Getr. / GBox: 9-Gang/gear 715.561 ohne Sensor / without sensor Füllmedium: Bremsflüssigkeit / Fill Medium: Brake Fluid Immer erneuern / Renew everytime	(104) (23) (28)	
			 1863 869 028				

AXOR 2436 - 2543		01.02 -					
2436 LS, 2536 LS 944.235 2440 LS, 2540 LS 944.235 2443 LS, 2543 LS 944.235 2535 LS 944.233 2540 LS 944.233 2543 LS 944.233	10.04 -	OM457.980, OM457.981, OM457.948, OM457.937	 3400 122 801 ⊕ ⊗ 3483 030 032 ⊗ 1878 005 165	430 18 MFZ430 430WGTZ	für / for: SA 531129-04/05	(68)	
	10.04 -		 3400 700 446 ⊕ ⊗ 3483 000 258 ⊗ 1878 005 165	430 18 MFZ430 430WGTZ	für / for: SA 504682-24	(68)	
	10.04 -		 3182 998 501	HHIS-3	Getr. / GBox: 9-Gang/gear 715.561 ohne Sensor / without sensor Füllmedium: Bremsflüssigkeit / Fill Medium: Brake Fluid Immer erneuern / Renew everytime	(104) (23) (28)	
	01.02 - 10.04		 1863 869 028				
01.02 - 10.04							
01.02 - 10.04							

		CODE		 Parameter		
--	--	------	--	---	---	---





































MERCEDES-BENZ

AXOR 2436 - 2543		01.02 -					
2523 375.321 2528 375.322 375.321	01.02 - 10.04	OM906.921, OM906.920	 3400 121 201 ◐  3482 000 464  1878 023 931	395 18 MF395 395GTZ	für / for: SA531129-01	(68)	
	01.02 - 10.04		 3400 121 301 ◐  3482 000 463  1878 023 831	395 18 MF395 395GTZ	für / for: SA531129-02	(68)	
			 3400 710 006  3482 000 464  1878 023 931  3182 998 501	395 18 MF395 395GTZ HHIS-3	ohne Sensor / without sensor Füllmedium: Bremsflüssigkeit / Fill Medium: Brake Fluid	(104) (23)	
			 3400 710 007  3482 000 463  1878 023 831  3182 998 501	395 18 MF395 395GTZ HHIS-3	ohne Sensor / without sensor Füllmedium: Bremsflüssigkeit / Fill Medium: Brake Fluid	(104) (23)	
			 3400 710 009  3482 000 464  1878 023 931  3182 600 101	395 18 MF395 395GTZ HHIS-3	mit Sensor / with sensor Füllmedium: Bremsflüssigkeit / Fill Medium: Brake Fluid	(92) (23)	
			 3400 710 010  3482 000 463  1878 023 831  3182 600 101	395 18 MF395 395GTZ HHIS-3	mit Sensor / with sensor Füllmedium: Bremsflüssigkeit / Fill Medium: Brake Fluid	(92) (23)	
			 3182 998 501	HHIS-3	für / for: SA504673-06/10 für / for: SA504673-07/22 ohne Sensor / without sensor Füllmedium: Bremsflüssigkeit / Fill Medium: Brake Fluid Immer erneuern / Renew everytime	(68) (68) (104) (23) (28)	
			 3182 600 101	HHIS-3	für / for: SA504673-08/11 mit Sensor / with sensor Füllmedium: Bremsflüssigkeit / Fill Medium: Brake Fluid Immer erneuern / Renew everytime	(68) (92) (23) (28)	
2523 K 375.323	01.02 - 10.04	OM906.920	 3400 121 201 ◐  3482 000 464  1878 023 931	395 18 MF395 395GTZ	für / for: SA531129-01	(68)	
			 3400 121 301 ◐  3482 000 463  1878 023 831	395 18 MF395 395GTZ	für / for: SA531129-02	(68)	
			 3400 710 006  3482 000 464  1878 023 931  3182 998 501	395 18 MF395 395GTZ HHIS-3	ohne Sensor / without sensor Füllmedium: Bremsflüssigkeit / Fill Medium: Brake Fluid	(104) (23)	
			 3400 710 007  3482 000 463  1878 023 831  3182 998 501	395 18 MF395 395GTZ HHIS-3	ohne Sensor / without sensor Füllmedium: Bremsflüssigkeit / Fill Medium: Brake Fluid	(104) (23)	
			 3182 998 501	HHIS-3	für / for: SA504673-10 ohne Sensor / without sensor Füllmedium: Bremsflüssigkeit / Fill Medium: Brake Fluid Immer erneuern / Renew everytime	(68) (104) (23) (28)	

































		CODE				
--	--	------	--	---	---	---

MERCEDES-BENZ

AXOR 2436 - 2543 01.02 -





















2528 950.624 950.626 950.623 950.625 2528 L, 2529 L 950.604 950.608 950.606 950.613/614 950.602/603 950.607 950.605 950.601 2533 950.624-626 950.623 2533, 2533 L 950.604 950.606 958.252 950.608 950.601 950.614 950.602/603 950.605 950.607 950.613 958.254/255 958.250	01.04 -	OM906LA		3400 121 301   3482 000 463  1878 023 831	395 18 MF395 395GTZ			
	10.04 -			3400 710 007   3482 000 463  1878 023 831  3182 998 501	395 18 MF395 395GTZ HHIS-3	ohne Sensor / without sensor Füllmedium: Bremsflüssigkeit / Fill Medium: Brake Fluid	(104) (23)	
	01.04 -				3400 710 010   3482 000 463  1878 023 831  3182 600 101	395 18 MF395 395GTZ HHIS-3	mit Sensor / with sensor Füllmedium: Bremsflüssigkeit / Fill Medium: Brake Fluid	(92) (23)
	10.04 -				3400 700 414   3483 030 031  1878 002 732	430 18 MFZ430 430WGTZ	für / for: SA504682-09	(68)
					3483 030 031   1878 002 731	430 MFZ430	für / for: SA504682-09	(68)
					1878 002 731   3483 000 139 	430 18 430WGTZ	für / for: SA504682-10 für Nebenantrieb / for PTO nicht in Verbindung mit Austausch-Kupplungsscheibe / not in connection with replacement clutch disc	(68) (82) (99)
					1878 002 732 	430 18 430WGTZ	für / for: SA504682-10 für Nebenantrieb / for PTO	(68) (82)
			OM906		3151 000 396 	KZIS-4	für OE-Nummer / for OE number 001 250 99 15 für OE-Nummer / for OE number 002 250 00 15	(83) (83)
					3400 122 801   3483 030 032  1878 005 165	430 18 MFZ430 430WGTZ	für / for: SA 531129-04/05	(68)
					3400 700 446   3483 000 258  1878 005 165	430 18 MFZ430 430WGTZ	für / for: SA 504682-24	(68)

AXOR 2623 - 2831 09.01 -

2623 L 375.351 2628 L 375.351	01.02 - 10.04	OM906.921, OM906.920		3400 121 201   3482 000 464  1878 023 931	395 18 MF395 395GTZ	für / for: SA531129-01	(68)	
	01.02 - 10.04			3400 121 301   3482 000 463  1878 023 831	395 18 MF395 395GTZ	für / for: SA531129-02	(68)	
					3400 710 006   3482 000 464  1878 023 931  3182 998 501	395 18 MF395 395GTZ HHIS-3	ohne Sensor / without sensor Füllmedium: Bremsflüssigkeit / Fill Medium: Brake Fluid	(104) (23)
					3400 710 007   3482 000 463  1878 023 831  3182 998 501	395 18 MF395 395GTZ HHIS-3	ohne Sensor / without sensor Füllmedium: Bremsflüssigkeit / Fill Medium: Brake Fluid	(104) (23)
					3400 710 009   3482 000 464  1878 023 931  3182 600 101	395 18 MF395 395GTZ HHIS-3	mit Sensor / with sensor Füllmedium: Bremsflüssigkeit / Fill Medium: Brake Fluid	(92) (23)
					3400 710 010   3482 000 463  1878 023 831  3182 600 101	395 18 MF395 395GTZ HHIS-3	mit Sensor / with sensor Füllmedium: Bremsflüssigkeit / Fill Medium: Brake Fluid	(92) (23)
					3182 998 501 	HHIS-3	für / for: SA504673-06/10 für / for: SA504673-07/22 ohne Sensor / without sensor Füllmedium: Bremsflüssigkeit / Fill Medium: Brake Fluid Immer erneuern / Renew everytime	(68) (68) (104) (23)
					3182 600 101 	HHIS-3	für / for: SA504673-08/11 mit Sensor / with sensor	(68) (92)



		CODE					
--	--	------	--	--	---	---	---





















MERCEDES-BENZ

AXOR 2623 - 2831		09.01 -				
2628, 2629 950.642/643 2633 950.642/643	10.04-	OM906LA	 3400 121 301 ◐ ⊗ 3482 000 463 ⊗ 1878 023 831	395 18 MF395 395GTZ		
	10.04-		 3400 710 007 ⊗ 3482 000 463 ⊗ 1878 023 831 ↘ 3182 998 501	395 18 MF395 395GTZ HHIS-3	ohne Sensor / without sensor Füllmedium: Bremsflüssigkeit / Fill Medium: Brake Fluid	(104) (23)
			 3400 710 010 ⊗ 3482 000 463 ⊗ 1878 023 831 ↘ 3182 600 101	395 18 MF395 395GTZ HHIS-3	mit Sensor / with sensor Füllmedium: Bremsflüssigkeit / Fill Medium: Brake Fluid	(92) (23)
			 3483 030 031 ⊕	430 MFZ430	für / for: SA504682-09	(68)
			 1878 002 731	430 18 430GTZ	für / for: SA504682-09	(68)
			 3483 000 139 ⊕	430 GMFZ430N	für / for: SA504682-10 für Nebenantrieb / for PTO nicht in Verbindung mit Austausch-Kupplungsscheibe / not in connection with replacement clutch disc	(68) (82) (99)
			 1878 002 732	430 18 430WGTZ	für / for: SA504682-10 für Nebenantrieb / for PTO	(68) (82)
	OM906	 3151 000 396	KZIS-4	für OE-Nummer / for OE number 001 250 99 15 für OE-Nummer / for OE number 002 250 00 15	(83) (83)	
2628 B, 2629 B 953.641 953.643	10.04-	OM906	 3400 121 201 ◐ ⊗ 3482 000 464 ⊗ 1878 023 931	395 18 MF395 395GTZ		
		OM906LA	 3400 121 301 ◐ ⊗ 3482 000 463 ⊗ 1878 023 831	395 18 MF395 395GTZ		
			 3400 700 414 HD ⊕ ⊗ 3483 030 031 ⊗ 1878 002 732	430 18 MFZ430 430WGTZ		
		OM926	 3400 700 446 ⊕ ⊗ 3483 000 258 ⊗ 1878 005 165	430 18 MFZ430 430WGTZ		
2628 B 375.374 2628 K 375.373	01.02 - 10.04	OM906.921	 3400 121 201 ◐ ⊗ 3482 000 464 ⊗ 1878 023 931	395 18 MF395 395GTZ	für / for: SA531129-01	(68)
	01.02 - 10.04		 3400 121 301 ◐ ⊗ 3482 000 463 ⊗ 1878 023 831	395 18 MF395 395GTZ	für / for: SA531129-02	(68)
			 3400 710 006 ⊗ 3482 000 464 ⊗ 1878 023 931 ↘ 3182 998 501	395 18 MF395 395GTZ HHIS-3	ohne Sensor / without sensor Füllmedium: Bremsflüssigkeit / Fill Medium: Brake Fluid	(104) (23)
			 3400 710 007 ⊗ 3482 000 463 ⊗ 1878 023 831 ↘ 3182 998 501	395 18 MF395 395GTZ HHIS-3	ohne Sensor / without sensor Füllmedium: Bremsflüssigkeit / Fill Medium: Brake Fluid	(104) (23)
			 3182 998 501	HHIS-3	für / for: SA504673-10 ohne Sensor / without sensor Füllmedium: Bremsflüssigkeit / Fill Medium: Brake Fluid Immer erneuern / Renew everytime	(68) (104) (23) (28)
2636 B 943.143 943.142 2636 B 943.141 2636 K 942.141-143 2636 K 942.141 2640 B 943.142/143 943.141 2640 K 942.142 942.141 942.143 2643 B 943.142 943.141 943.143 2643 K 942.142 942.141 942.143 2643 K 942.141	10.04-	OM457.980, OM457.981, OM457.948, OM457.956, OM457.957, OM457LA, OM457.937	 3400 122 801 ⊕ ⊗ 3483 030 032 ⊗ 1878 005 165	430 18 MFZ430 430WGTZ		
	01.01-		 3400 121 501 ⊕ ⊗ 3488 023 031 ⊗ 1878 002 024	400 18 MFZ2/400X 400WGTZ	Nabenprofil / Hub Profile: 45x50-18N für Fahrzeuge mit Zweischeibenkupplung / for vehicles with double disc clutch	(46) (77)
	10.04-		 1863 869 028			
	01.01-					
	10.04-					
	10.04-					
	10.04-					
	10.04-					
	10.04-					
	01.01-					

		CODE					
--	--	------	--	--	---	---	---





MERCEDES-BENZ

AXOR 2623 - 2831		09.01 -			
2640 S 958.451	10.04-	OM457.918	 3400 700 355 ⊕  3488 000 158  1878 002 019	400 18 MFZ2/400X 400WGTZ	

AXOR 3028 - 4144		09.01 -					
3236 B 943.304/305	10.04-	OM457.980, OM457.981, OM457.956, OM457.957	 3400 122 801 ⊕  3483 030 032  1878 005 165	430 18 MFZ430 430WGTZ			
3236 K 942.304/305 942.307	10.04-		 3400 121 501 ⊕  3488 023 031  1878 002 024	400 18 MFZ2/400X 400WGTZ	Nabenprofil / Hub Profile: 45x50-18N für Fahrzeuge mit Zweis Scheibenkupplung / for vehicles with double disc clutch	(46) (77)	
3240 B 943.305 943.304	10.04-		 1863 869 028				
3240 K 942.305 942.304 942.307	10.04-						
3243 B 943.305 943.304	10.04-						
3243 K 942.305 942.307 942.304	10.04-						
4135 B 943.317 943.314	10.05-						
4135 K 942.314 942.317 942.315	06.09-						
4140 B 943.317 943.314	06.09-						
4140 K 942.314/315 942.317	06.09-						
4143 B 943.317 943.314	06.09-						
4143 K 942.314/315 942.317	06.09-						
3240 940.365	03.05-	OM457.948, OM457.937	 3400 122 801 ⊕  3483 030 032  1878 005 165	430 18 MFZ430 430WGTZ			
3243 940.365	10.04-		 1863 869 028				
3335 940.163	10.04-	OM457.910, OM457.918, OM457.956, OM457.957, OM457.937, OM457.917	 3400 122 801 ⊕  3483 030 032  1878 005 165	430 18 MFZ430 430WGTZ			
3340 958.478 958.471 940.163 958.472	10.04-		 3400 121 501 ⊕  3488 023 031  1878 002 024	400 18 MFZ2/400X 400WGTZ	für / for: SA 504682-13 für / for: SA 591014-04 Nabenprofil / Hub Profile: 45x50-18N für Fahrzeuge mit Zweis Scheibenkupplung / for vehicles with double disc clutch	(68) (68) (46) (77)	
3343 B 943.163 943.162	10.04-		 1863 869 028				
3340 K 942.162 958.471 958.478 942.161 942.163 942.167 958.472 942.165	10.04-						
3343 940.163	10.04-						
3340 S 958.471/472 958.478 944.161	06.09-			OM457.962, OM457.910, OM457.918, OM457.956, OM457.957, OM457.917	 3400 700 355 ⊕  3488 000 158  1878 002 019	400 18 MFZ2/400X 400WGTZ	
3344 K 958.471 942.162 942.314 958.478 958.472	01.11-						
4140 958.471 958.478 958.472	01.11-						
4144 958.472 958.471 958.478	01.11-						























		CODE				
--	--	------	--	---	---	---

MERCEDES-BENZ

ECONIC		03.98 -					
1823 L, 1823 LL 957.543 957.542 957.540/541	03.98-	M906LAG		3400 700 615 ⊕ ⊗ 3483 030 031 ⊙ 1878 002 731	430 18 MFZ430 430GTZ		
1828 L, 1828 LL 957.540/541 957.543 957.542	03.98-						
2628 LL 957.662 957.657 957.661 957.656 957.654 957.660 957.663 957.666 957.653 957.664	03.98-						
2628 LL 957.682 957.681	01.98-						
1824 L, 1824 LL 957.540 957.542/543 957.545 957.541	10.06-	OM926.934, M902.900, OM902.927, OM902.933, OM926LAG, M902.903, OM926.924		3400 700 615 ⊕ ⊗ 3483 030 031 ⊙ 1878 002 731	430 18 MFZ430 430GTZ		
1828 L, 1828 LL 957.540 957.545 957.543 957.541/542							
1829 L, 1829 LL 957.545 957.542 957.540/541 957.543	10.06-						
1833 L, 1833 LL 957.543 957.540/541 957.545 957.542	10.06-						
2628 NGT 957.660							
2629 L, 2629 LL 957.654 957.656/657 957.660 957.663 957.653 957.664 957.661/662							
2629 L, 2629 LL 957.682 957.681	10.01-						
2633 L, 2633 LL 957.654 957.663/664 957.662 957.657 957.661 957.653 957.660 957.656							
3233 L, 3233 LL 957.382							
ECONIC 2		04.13 -					
1830 LL 956.005 956.008 956.003 956.001 956.004	04.13-	OM936		3400 700 533 ⊕	430 18	XTend Nabenprofil / Hub Profile: 45x50-18N Abgasnorm: Euro 6 / Exhaust Emission Norm: Euro 6 max. übertragbares Motormoment [Nm] / max. transmittable engine torque [Nm]: 2100 Nur zusammen verbauen / Only install together	(46) (4) (87) (51)
2630 LL 956.064 956.063	04.13-						
2630 LL 956.033 956.053 956.031 956.034-036	04.13-			3400 700 531 ⊕	430 18	XTend Getr. / GBox: Powershift Nabenprofil / Hub Profile: 45x50x-18N Abgasnorm: Euro 6 / Exhaust Emission Norm: Euro 6 max. übertragbares Motormoment [Nm] / max. transmittable engine torque [Nm]: 2100 Nur zusammen verbauen / Only install together	(46) (4) (87) (51)
				6482 000 218	PHIS-6/38	Getr. / GBox: Powershift Abgasnorm: Euro 6 / Exhaust Emission Norm: Euro 6 Immer erneuern / Renew everytime	(4) (28)



















		CODE				
--	--	------	--	---	---	---

MERCEDES-BENZ

Unimog 32-100							
U 40 421.123 421.122 U 45 421.123 421.122	01.66 - 04.71	OM621.931, OM615.911		1882 231 131 #	250 G250		
	01.66 - 04.71			1861 840 133 #	250 10 250TPZ		
				1863 840 001	GR-3	ohne Anlauftring / without thrust ring	(102)
				1888 893 001 #	225 24 DOT240	für / for: SA35334 01 für / for: SA35452 01 für Fahrzeuge mit Zweischeibenkupplung / for vehicles with double disc clutch enthält eine Kupplungsscheibe / This part number includes one clutch disc	(68) (68) (77) (66)
				1862 718 002 ▽#	240 10 240CC	für / for: SA35334 01 für / for: SA35452 01 für Fahrzeuge mit Zweischeibenkupplung / for vehicles with double disc clutch Lose Kupplungsscheibe / Loose clutch disc	(68) (68) (77) (39)
				1863 869 010	35	Nadellager / Needle Bearing	(47)
U 52 421.122-163 U 60,T 421.122-163				1882 231 131 #	250 G250		
				1861 840 133 #	250 10 250TPZ		
				1863 840 001	GR-3	ohne Anlauftring / without thrust ring	(102)
				1888 893 001 #	225 24 DOT240	Chass. 002949 - Chass. 166589 enthält eine Kupplungsscheibe / This part number includes one clutch disc	(66)
				1862 718 002 ▽#	240 10 240CC	Chass. 002949 - Chass. 166589 Lose Kupplungsscheibe / Loose clutch disc	(39)
				1863 837 003	GR-4	Chass. 002949 - Chass. 166589 ohne Anlauftring / without thrust ring	(102)
U 54 403.121 403.120	04.66 - 03.72	OM314.916		1888 877 101 #	280 DOT280	Chass. 000760 - Chass. 088736 für Fahrzeuge mit Zweischeibenkupplung / for vehicles with double disc clutch enthält zwei Kupplungsscheiben / This part number includes both clutch discs	(77) (67)
				1882 229 131 #	280 G280	-> Chass. 088736	
				1861 518 031 #	280 10 280BDC	-> Chass. 088736 Anzahl der Beläge / Number of pads: 6	(8)
				1861 611 131 ●#	280 10 280B/Z	-> Chass. 088736	
				1863 840 001	GR-3	-> Chass. 088736 ohne Anlauftring / without thrust ring	(102)
				3482 008 032	310 MF310	Chass. 088737->	
				1861 384 334 #	310 10 310GSZ	Chass. 088737->	
				1863 840 001	GR-3	Chass. 088737-> ohne Anlauftring / without thrust ring	(102)
U 55,T 421.130/131				1882 231 131 #	250 G250		
				1861 840 133 #	250 10 250TPZ		
				1863 840 001	GR-3	ohne Anlauftring / without thrust ring	(102)



























		CODE				
--	--	------	--	---	---	---

MERCEDES-BENZ

Unimog 32-100							
U 65 T, U 70 T 406.130/131	01.62 - 01.88	OM352.919		1888 877 101 #	280 DOT280	Chass. 009059 - Chass. 088736 406.130 enthält zwei Kupplungsscheiben / This part number includes both clutch discs (67)	
				1882 229 131 #	280 G280	->Chass. 088736	
				1861 518 031 #	280 10 280BDC	->Chass. 088736 Anzahl der Beläge / Number of pads: 6 (8)	
				1861 611 131 ●#	280 10 280B/Z	->Chass. 088736	
				1863 840 001	GR-3	->Chass. 088736 ohne Anlauftring / without thrust ring (102)	
				3482 008 032	310 MF310	Chass. 088737->	
				1861 384 334 #	310 10 310GSZ	Chass. 088737->	
				1863 840 001	GR-3	Chass. 088737-> ohne Anlauftring / without thrust ring (102)	
U 65, U 70 406.121 406.120 U 65, U 70 406.120/121	01.62 - 01.88	OM352.919, OM312.954		1888 877 101 #	280 DOT280	Chass. 009059 - Chass. 088736 für Fahrzeuge mit Zweis Scheibenkupplung / for vehicles with double disc clutch enthält zwei Kupplungsscheiben / This part number includes both clutch discs (77)	
				1882 229 131 #	280 G280	->Chass. 088736	
				1861 518 031 #	280 10 280BDC	->Chass. 088736 Anzahl der Beläge / Number of pads: 6 (8)	
				1861 611 131 ●#	280 10 280B/Z	->Chass. 088736	
				1863 840 001	GR-3	->Chass. 088736 ohne Anlauftring / without thrust ring (102)	
	01.62 - 01.88			3482 008 032	310 MF310	Chass. 088737->	
				1861 384 334 #	310 10 310GSZ	Chass. 088737->	
				1863 840 001	GR-3	Chass. 088737-> ohne Anlauftring / without thrust ring (102)	
				1888 877 102 #	280 24 DOT280	Chass. 088737-> für Fahrzeuge mit Zweis Scheibenkupplung / for vehicles with double disc clutch enthält eine Kupplungsscheibe / This part number includes one clutch disc (77) (66)	
				1861 966 141 ▽#	280 10 280GSPD CE/ CERAM	Chass. 088737-> für Fahrzeuge mit Zweis Scheibenkupplung / for vehicles with double disc clutch Lose Kupplungsscheibe / Loose clutch disc (77) (39)	
			1863 837 003	GR-4	Chass. 088737-> für Fahrzeuge mit Zweis Scheibenkupplung / for vehicles with double disc clutch ohne Anlauftring / without thrust ring (77) (102)		





















		CODE				
--	--	------	--	---	---	---

MERCEDES-BENZ

Unimog 32-100							
U 66, U 72 403.122/123	03.69-01.88	OM314.917		1882 229 131 #	280 G280	->Chass. 088736	
				1861 518 031 #	280 10 280BDC	->Chass. 088736 Anzahl der Beläge / Number of pads: 6	(8)
				1861 611 131 ●#	280 10 280B/Z	->Chass. 088736	
				1863 840 001	GR-3	->Chass. 088736 ohne Anlauftring / without thrust ring	(102)
				3482 008 032	310 MF310	Chass. 088737->	
				1861 384 334 #	310 10 310GSZ	Chass. 088737->	
				1863 840 001	GR-3	Chass. 088737-> ohne Anlauftring / without thrust ring	(102)
				1888 877 101 #	280 DOT280	Chass. 000760 - Chass. 088736 enthält zwei Kupplungsscheiben / This part number includes both clutch discs	(67)
				1888 877 102 #	280 24 DOT280	Chass. 088737-> enthält eine Kupplungsscheibe / This part number includes one clutch disc	(66)
				1861 966 141 ▽#	280 10 280GSPD CE/ CERAM	Chass. 088737-> Lose Kupplungsscheibe / Loose clutch disc	(39)
				1863 837 003	GR-4	Chass. 088737-> ohne Anlauftring / without thrust ring	(102)
U 72, U 80 413.111 413.110	01.69-01.77	OM314.917		1882 229 131 #	280 G280	->Chass. 088736	
				1861 518 031 #	280 10 280BDC	->Chass. 088736 Anzahl der Beläge / Number of pads: 6	(8)
				1861 611 131 ●#	280 10 280B/Z	->Chass. 088736	
				1863 840 001	GR-3	->Chass. 088736 ohne Anlauftring / without thrust ring	(102)
				3482 008 032	310 MF310	Chass. 088737->	
				1861 384 334 #	310 10 310GSZ	Chass. 088737->	
				1863 840 001	GR-3	Chass. 088737-> ohne Anlauftring / without thrust ring	(102)
				1888 877 101 #	280 DOT280	->Chass. 088736 enthält zwei Kupplungsscheiben / This part number includes both clutch discs	(67)
U 80 T, U 90 T 416.133 416.130 406.133	05.66-	OM352.903, OM352.984		1882 229 131 #	280 G280	->Chass. 088736	
				1861 518 031 #	280 10 280BDC	->Chass. 088736 Anzahl der Beläge / Number of pads: 6	(8)
				1861 611 131 ●#	280 10 280B/Z	->Chass. 088736	
				1863 840 001	GR-3	->Chass. 088736 ohne Anlauftring / without thrust ring	(102)
				3482 008 032	310 MF310	Chass. 088737->	
				1861 384 334 #	310 10 310GSZ	Chass. 088737->	
				1863 840 001	GR-3	Chass. 088737-> ohne Anlauftring / without thrust ring	(102)







		CODE					
--	--	------	--	--	---	---	---





















MERCEDES-BENZ

Unimog 32-100										
U 80, U 84, U 90 416.125/126 416.123/124 406.121 416.122 416.127	05.69 - 01.88	OM352.903, OM353.902		1888 877 101 #	280 DOT280	Chass. 009059 - Chass. 088736 406.121 für Fahrzeuge mit Zweischeibenkupplung / for vehicles with double disc clutch enthält zwei Kupplungsscheiben / This part number includes both clutch discs	(77) (67)			
				1882 229 131 #	280 G280	->Chass. 088736 406.121/122-125				
				1861 518 031 #	280 10 280BDC	->Chass. 088736 406.121/122-125 Anzahl der Beläge / Number of pads: 6	(8)			
				1861 611 131 ●#	280 10 280B/Z	->Chass. 088736 406.121/122-125				
				1863 840 001	GR-3	->Chass. 088736 406.121/122-125 ohne Anlauftring / without thrust ring	(102)			
				3482 008 032	310 MF310	Chass. 088737-> 406.121/122-125				
				1861 384 334 #	310 10 310GSZ	Chass. 088737-> 406.121/122-125				
				1863 840 001	GR-3	Chass. 088737-> 406.121/122-125 ohne Anlauftring / without thrust ring	(102)			
				1888 877 102 #	280 24 DOT280	Chass. 088737-> 406.121 für Fahrzeuge mit Zweischeibenkupplung / for vehicles with double disc clutch enthält eine Kupplungsscheibe / This part number includes one clutch disc	(77) (66)			
				1861 966 141 ▽#	280 10 280GSPD CE/ CERAM	Chass. 088737-> 406.121 für Fahrzeuge mit Zweischeibenkupplung / for vehicles with double disc clutch Lose Kupplungsscheibe / Loose clutch disc	(77) (39)			
				1863 837 003	GR-4	Chass. 088737-> 406.121 für Fahrzeuge mit Zweischeibenkupplung / for vehicles with double disc clutch ohne Anlauftring / without thrust ring	(77) (102)			
				1882 229 131 #	280 G280	->Chass. 003772 406.126-127				
				1861 518 031 #	280 10 280BDC	->Chass. 003772 406.126-127 Anzahl der Beläge / Number of pads: 6	(8)			
				1861 611 131 ●#	280 10 280B/Z	->Chass. 003772 406.126-127				
				1863 840 001	GR-3	->Chass. 003772 406.126-127 ohne Anlauftring / without thrust ring	(102)			
				1882 282 331	310 GFX310	Chass. 003773 - Chass. 088736 406.126-127 Nur bei Altteil-Rückgabe lieferbar (Reparatur; Werk Bielefeld) / Please return old unit for repair (plant Bielefeld)	(49)			
				1861 384 334 #	310 10 310GSZ	Chass. 003773 - Chass. 088736 406.126-127				
				1863 840 001	GR-3	Chass. 003773 - Chass. 088736 406.126-127 ohne Anlauftring / without thrust ring	(102)			
			U 84 406.143 406.145 406.142				1882 282 331	310 GFX310	Chass. 003773 - Chass. 088736 Nur bei Altteil-Rückgabe lieferbar (Reparatur; Werk Bielefeld) / Please return old unit for repair (plant Bielefeld)	(49)
							1861 384 334 #	310 10 310GSZ	Chass. 003773 - Chass. 088736	
	1863 840 001	GR-3				Chass. 003773 - Chass. 088736 ohne Anlauftring / without thrust ring	(102)			

		CODE					
--	--	------	--	--	---	---	---





























MERCEDES-BENZ

Unimog 32-100							
U 84 (406)				1888 067 042 #	330 22 DUT330/ 310	enthält eine Kupplungsscheibe / This part number includes one clutch disc enthält Druckplattenbefestigungsschrauben / includes bolt for pressure plate mounting	(66) (64)
				1861 741 042 ▽#	327 20 327GSDC	Anzahl der Beläge / Number of pads: 8 Lose Kupplungsscheibe / Loose clutch disc	(8) (39)
				1863 837 002	GR-4	mit Anlauftring / with thrust ring	(88)
				1863 855 000	GR-8	mit Anlauftring / with thrust ring	(88)
U 90 408.101	07.96-	OM602		3082 269 031	250 M250	408.101	
				3182 002 132	HHIS-3	408.101 Immer erneuern / Renew everytime	(28)
U 94 403.120-123				1888 877 101 #	280 DOT280	Chass. 000760 - Chass. 088736 enthält zwei Kupplungsscheiben / This part number includes both clutch discs	(67)

Unimog 100-500							
411	01.52-			1881 089 009 ▲	225 K225		
				1862 088 131	225 10 225B/Z	Nur bei Altteil-Rückgabe lieferbar (Reparatur; Werk Bielefeld) / Please return old unit for repair (plant Bielefeld)	(49)
				1859 600 001	GR.I/ZL		
				1805 042 000			
S	01.54-			1862 088 131	225 10 225B/Z	Nur bei Altteil-Rückgabe lieferbar (Reparatur; Werk Bielefeld) / Please return old unit for repair (plant Bielefeld)	(49)
				3151 021 001	KTI-1		
				3130 010 100			
U 100,L,T 416.122-163 U 110,L,T 416.122-163 U 125 416.122-163				3482 008 032	310 MF310	Chass. 088737->	
				1861 384 334 #	310 10 310GSZ	Chass. 088737->	
				1863 840 001	GR-3	Chass. 088737-> ohne Anlauftring / without thrust ring	(102)
U 100,L,T 416.140-163 416.114-117 416.160 416.130-135 416.134 416.122-135				1882 229 131 #	280 G280	->Chass. 088736 416.122-125/130-135/160	
				1861 611 131 ●#	280 10 280B/Z	->Chass. 088736 416.122-125/130-135/160	
				1861 518 031 #	280 10 280BDC	->Chass. 088736 416.122-125/130-135/160 Anzahl der Beläge / Number of pads: 6	(8)
				1863 840 001	GR-3	ohne Anlauftring / without thrust ring	(102)
				1882 282 331	310 GFX310	->Chass. 088736 416.114-117/140-163 Nur bei Altteil-Rückgabe lieferbar (Reparatur; Werk Bielefeld) / Please return old unit for repair (plant Bielefeld)	(49)
				1861 384 334 #	310 10 310GSZ	->Chass. 088736 416.114-117/140-163	
				1863 840 001	GR-3	->Chass. 088736 416.122-125/130-135/160/114-117/140-163 ohne Anlauftring / without thrust ring	(102)
				1888 877 101 #	280 DOT280	Chass. 000562 - Chass. 088736 416.114-117/134-135/140-163 enthält zwei Kupplungsscheiben / This part number includes both clutch discs	(67)
				1888 877 102 #	280 24 DOT280	Chass. 088737 - Chass. 166589 416.114-117/134-135/140-163 enthält eine Kupplungsscheibe / This part number includes one clutch disc	(66)
				1888 877 103 #	280 24 DOT280	Chass. 166590-> 416.114-117/134-135/140-163 enthält eine Kupplungsscheibe / This part number includes one clutch disc	(66)
				1861 966 141 ▽#	280 10 280GSPD CE/ CERAM	Chass. 088737-> 416.114-117/134-135/140-163 Lose Kupplungsscheibe / Loose clutch disc	(39)





















		CODE				
--	--	------	--	---	---	---

MERCEDES-BENZ

Unimog 100-500							
U 100L 408.215	11.92-	OM602		3082 157 031	240 M240	408.215	
				3151 069 032	KZIS-1	408.215	
U 100L 408.216	07.96-	OM602LA		3082 269 031	250 M250	408.216	
				3151 069 032	KZIS-1	408.216	
U 110,L,T 416.141 416.140				1882 231 131 #	250 G250		
				1861 840 133 #	250 10 250TPZ		
				1863 840 001	GR-3	ohne Anlauftring / without thrust ring	(102)
U 110,L,T 416.122-125 416.140-163 416.130-135 416.134 416.114-117 416.160 416.135				1882 229 131 #	280 G280	->Chass. 088736 416.122-125/130-135/160	
				1861 518 031 #	280 10 280BDC	->Chass. 088736 416.122-125/130-135/160 Anzahl der Beläge / Number of pads: 6	(8)
				1861 611 131 ●#	280 10 280B/Z	->Chass. 088736 416.122-125/130-135/160	
				1863 840 001	GR-3	->Chass. 088736 416.114-117/140-163 ohne Anlauftring / without thrust ring	(102)
				1882 282 331	310 GFX310	->Chass. 088736 416.114-117/140-163 Nur bei Altteil-Rückgabe lieferbar (Reparatur; Werk Bielefeld) / Please return old unit for repair (plant Bielefeld)	(49)
				1861 384 334 #	310 10 310GSZ	->Chass. 088736 416.114-117/140-163	
				1863 840 001	GR-3	->Chass. 088736 416.122-125/130-135/160/114-117/140-163 ohne Anlauftring / without thrust ring	(102)
				1888 877 102 #	280 24 DOT280	Chass. 088737 - Chass. 166589 416.114-117/134-135/140-163 enthält eine Kupplungsscheibe / This part number includes one clutch disc	(66)
				1888 877 103 #	280 24 DOT280	Chass. 166590-> 416.114-117/134-135/140-163 enthält eine Kupplungsscheibe / This part number includes one clutch disc	(66)
				1861 966 141 ▽#	280 10 280GSPD CE/ CERAM	416.114-117/134-135/140-163 Lose Kupplungsscheibe / Loose clutch disc	(39)
				1888 067 042 #	330 22 DUT330/ 310	enthält eine Kupplungsscheibe / This part number includes one clutch disc	(66)
				1861 741 042 ▽#	327 20 327GSDC	Anzahl der Beläge / Number of pads: 8 Lose Kupplungsscheibe / Loose clutch disc	(8) (39)
				1863 837 002	GR-4	mit Anlauftring / with thrust ring	(88)
				1863 855 000	GR-8	mit Anlauftring / with thrust ring	(88)
U 110,U 110L 418.100 418.115	02.92-	OM364.958, OM364.955		3482 012 211	330 GMF330		
				1862 408 031 #	330 10 330TB		
				3182 002 131	HHIS-3	Immer erneuern / Renew everytime	(28)
				1888 998 201 #	330 24 DUT330	enthält eine Kupplungsscheibe / This part number includes one clutch disc	(66)
				1888 067 031 #	330 24 DUT330	für Fahrzeuge mit Niederdruck-Bremsanlage / for vehicles with low-pressure brakesystem	(74)
				1862 408 031 ▽#	330 10 330TB	Chass. 183541-> enthält eine Kupplungsscheibe / This part number includes one clutch disc	(66)
				1862 408 031 ▽#	330 10 330TB	Chass. 183541-> Lose Kupplungsscheibe / Loose clutch disc	(39)

























		CODE				
--	--	------	--	---	---	---

MERCEDES-BENZ

Unimog 100-500						
U 120 U 125 (425) U 150 (425)			 1888 067 042 #	330 22 DUT330/ 310	enthält eine Kupplungsscheibe / This part number includes one clutch disc enthält Druckplattenbefestigungsschrauben / includes bolt for pressure plate mounting	(66) (64)
			 1861 741 042 ▽#	327 20 327GSDC	Anzahl der Beläge / Number of pads: 8 Lose Kupplungsscheibe / Loose clutch disc	(8) (39)
			 1863 837 002	GR-4	mit Anlauftring / with thrust ring	(88)
			 1863 855 000	GR-8	mit Anlauftring / with thrust ring	(88)
U 125 416.114-117 416.140-163 416.135 416.134			 1882 282 331	310 GFX310	-> Chass. 088736 416.114-117/140-163 Nur bei Altteil-Rückgabe lieferbar (Reparatur; Werk Bielefeld) / Please return old unit for repair (plant Bielefeld)	(49)
			 1861 384 334 #	310 10 310GSZ	-> Chass. 088736 416.114-117/140-163	
			 1863 840 001	GR-3	-> Chass. 088736 416.114-117/140-163 ohne Anlauftring / without thrust ring	(102)
			 1888 877 101 #	280 DOT280	Chass. 000562 - Chass. 088736 416.114-117/134-135/140-163 enthält zwei Kupplungsscheiben / This part number includes both clutch discs	(67)
			 1888 877 102 #	280 24 DOT280	Chass. 088737 - Chass. 166589 416.114-117/134-135/140-163 enthält eine Kupplungsscheibe / This part number includes one clutch disc	(66)
			 1888 877 103 #	280 24 DOT280	Chass. 166590-> 416.114-117/134-135/140-163 enthält eine Kupplungsscheibe / This part number includes one clutch disc	(66)
			 1861 966 141 ▽#	280 10 280GSPD CE/ CERAM	416.114-117/134-135/140-163 Lose Kupplungsscheibe / Loose clutch disc	(39)
U 130,U 140 418.102 U 140T 418.000	07.92 - 07.92 -	OM364.985, OM364.982	 3482 012 211	330 GMF330	für Fahrzeuge mit Einscheibenkupplung / for vehicles with single disc clutch	(71)
			 1862 408 031 #	330 10 330TB	für Fahrzeuge mit Einscheibenkupplung / for vehicles with single disc clutch	(71)
			 3182 002 131	HHIS-3	für Fahrzeuge mit Einscheibenkupplung / for vehicles with single disc clutch Immer erneuern / Renew everytime	(71) (28)
			 1888 998 201 #	330 24 DUT330	-> Chass. 183540 für Fahrzeuge mit Niederdruck-Bremsanlage / for vehicles with low-pressure brakesystem enthält eine Kupplungsscheibe / This part number includes one clutch disc	(74) (66)
			 3182 002 131	HHIS-3	Immer erneuern / Renew everytime	(28)
			 1888 067 031 #	330 24 DUT330	enthält eine Kupplungsscheibe / This part number includes one clutch disc Sonderausführung / Special design	(66) (56)
			 1888 998 201 #	330 24 DUT330	für Fahrzeuge mit Niederdruck-Bremsanlage / for vehicles with low-pressure brakesystem enthält eine Kupplungsscheibe / This part number includes one clutch disc Sonderausführung / Special design	(74) (66) (56)
			 1862 408 031 ▽#	330 10 330TB	Lose Kupplungsscheibe / Loose clutch disc Sonderausführung / Special design	(39) (56)
			 3182 003 131	HHIS-3	Sonderausführung / Special design Immer erneuern / Renew everytime	(56) (28)





























		CODE				
--	--	------	--	---	---	---

MERCEDES-BENZ

Unimog 100-500						
U 140L 418.117 418.237 418.217	07.92-	OM364.985	 3482 012 211	330 GMF330	418.117 für Fahrzeuge mit Einscheibenkupplung / for vehicles with single disc clutch	(71)
			 1862 408 031 #	330 10 330TB	418.117 für Fahrzeuge mit Einscheibenkupplung / for vehicles with single disc clutch	(71)
			 3182 002 131	HHIS-3	418.117 für Fahrzeuge mit Einscheibenkupplung / for vehicles with single disc clutch Immer erneuern / Renew everytime	(71) (28)
			 1888 998 201 #	330 24 DUT330	->Chass. 183540 418.117 für Fahrzeuge mit Niederdruck-Bremsanlage / for vehicles with low-pressure brakesystem enthält eine Kupplungsscheibe / This part number includes one clutch disc	(74) (66)
			 3182 002 131	HHIS-3	418.117 Immer erneuern / Renew everytime	(28)
			 1888 067 031 #	330 24 DUT330	418.117 enthält eine Kupplungsscheibe / This part number includes one clutch disc Sonderausführung / Special design	(66) (56)
			 1888 998 201 #	330 24 DUT330	418.117 für Fahrzeuge mit Niederdruck-Bremsanlage / for vehicles with low-pressure brakesystem enthält eine Kupplungsscheibe / This part number includes one clutch disc Sonderausführung / Special design	(74) (66) (56)
			 1862 408 031 ▽#	330 10 330TB	418.117 Lose Kupplungsscheibe / Loose clutch disc Sonderausführung / Special design	(39) (56)
			 3182 003 131	HHIS-3	418.117 Sonderausführung / Special design Immer erneuern / Renew everytime	(56) (28)
U 300 405.101 405.100 U 300 405.121 405.120	03.00- 03.00-	OM904.927, OM904.928	 3482 000 462	362 MF362	für Fahrzeuge mit Einscheibenkupplung / for vehicles with single disc clutch	(71)
			 1878 600 560	360 18 360CBC	für Fahrzeuge mit Einscheibenkupplung / for vehicles with single disc clutch Anzahl der Beläge / Number of pads: 9	(71) (8)
			 3182 600 101	HHIS-3	für Fahrzeuge mit Einscheibenkupplung / for vehicles with single disc clutch mit Sensor / with sensor Füllmedium: Bremsflüssigkeit / Fill Medium: Brake Fluid Immer erneuern / Renew everytime	(71) (92) (23) (28)
			 3400 127 701 ●  3482 000 462  1878 052 842	362 18 MF362 362WG TB	für Fahrzeuge mit Einscheibenkupplung / for vehicles with single disc clutch	(71)
			 1878 001 939 HD●	362 18 362WG TB	für Fahrzeuge mit Einscheibenkupplung / for vehicles with single disc clutch	(71)
			 3400 710 008 ●  3482 000 462  1878 052 842  3182 600 101	362 18 MF362 362WG TB HHIS-3	für Fahrzeuge mit Einscheibenkupplung / for vehicles with single disc clutch mit Sensor / with sensor Füllmedium: Bremsflüssigkeit / Fill Medium: Brake Fluid	(71) (92) (23)
			 1888 916 001 #	350 24 DUT350	für Fahrzeuge mit Zweisheibenkupplung / for vehicles with double disc clutch enthält eine Kupplungsscheibe / This part number includes one clutch disc	(77) (66)
			 1878 992 401 #	350 20 350GSDC	für Fahrzeuge mit Zweisheibenkupplung / for vehicles with double disc clutch Anzahl der Beläge / Number of pads: 8	(77) (8)
			 1863 837 002	GR-4	für Fahrzeuge mit Zweisheibenkupplung / for vehicles with double disc clutch mit Anlauftring / with thrust ring	(77) (88)
			 1863 855 000	GR-8	für Fahrzeuge mit Zweisheibenkupplung / for vehicles with double disc clutch mit Anlauftring / with thrust ring	(77) (88)





		CODE					
--	--	------	--	--	---	---	---



























MERCEDES-BENZ

Unimog 100-500								
U 400 405.103 405.102	03.00-	OM904.928		3482 000 462	362 MF362			
				1878 600 560	360 18 360CBC	Anzahl der Beläge / Number of pads: 9	(8)	
				3182 600 101	HHIS-3	mit Sensor / with sensor Füllmedium: Bremsflüssigkeit / Fill Medium: Brake Fluid Immer erneuern / Renew everytime	(92) (23) (28)	
				3400 127 701 ●	362 18 MF362 362WGTTB			
				3400 700 484 HD ●	362 10 MF362 362WGTTB			
				3400 710 008 ●	362 18 MF362 362WGTTB HHIS-3	mit Sensor / with sensor Füllmedium: Bremsflüssigkeit / Fill Medium: Brake Fluid	(92) (23)	
				1888 916 001 #	350 24 DUT350	für Fahrzeuge mit Zweischeibenkupplung / for vehicles with double disc clutch enthält eine Kupplungsscheibe / This part number includes one clutch disc	(77) (66)	
				1878 992 401 #	350 20 350GSDC	für Fahrzeuge mit Zweischeibenkupplung / for vehicles with double disc clutch Anzahl der Beläge / Number of pads: 8	(77) (8)	
				1863 837 002	GR-4	für Fahrzeuge mit Zweischeibenkupplung / for vehicles with double disc clutch mit Anlauffring / with thrust ring	(77) (88)	
				1863 855 000	GR-8	für Fahrzeuge mit Zweischeibenkupplung / for vehicles with double disc clutch mit Anlauffring / with thrust ring	(77) (88)	
					OM906		3151 000 396	KZIS-4
U 400 405.122/123 U 500, UGN NA 405.200 405.210 405.230 405.221 405.201 U 500, UGN NA 405.221 405.220 405.201 405.210 405.230	03.00-	OM906.935, OM906.967, OM906.955		3482 000 463	395 MF395			
			10.00-		1878 600 560	360 18 360CBC	Anzahl der Beläge / Number of pads: 9	(8)
					1878 052 842 ●	362 18 362WGTTB		
					1878 001 939 HD ●	362 18 362WGTTB		
	10.00-			3182 600 101	HHIS-3	mit Sensor / with sensor Füllmedium: Bremsflüssigkeit / Fill Medium: Brake Fluid Immer erneuern / Renew everytime	(92) (23) (28)	
				1888 916 001 #	350 24 DUT350	für Fahrzeuge mit Zweischeibenkupplung / for vehicles with double disc clutch enthält eine Kupplungsscheibe / This part number includes one clutch disc	(77) (66)	
				1878 992 401 #	350 20 350GSDC	für Fahrzeuge mit Zweischeibenkupplung / for vehicles with double disc clutch Anzahl der Beläge / Number of pads: 8	(77) (8)	
				1863 837 002	GR-4	für Fahrzeuge mit Zweischeibenkupplung / for vehicles with double disc clutch mit Anlauffring / with thrust ring	(77) (88)	
				1863 855 000	GR-8	für Fahrzeuge mit Zweischeibenkupplung / for vehicles with double disc clutch mit Anlauffring / with thrust ring	(77) (88)	
					OM906		3151 000 396	KZIS-4
U S 404 404.113-115	01.55 - 12.76	M180.953, M180.952		1862 088 131	225 10 225B/Z	Nur bei Altteil-Rückgabe lieferbar (Reparatur; Werk Bielefeld) / Please return old unit for repair (plant Bielefeld)	(49)	
				3151 021 001	KTI-1			
				1863 869 010	35	Nadellager / Needle Bearing	(47)	
U S 404 404.117	01.68 -	OM615.911		1882 231 131 #	250 G250			
				1861 840 133 #	250 10 250TPZ			
				1863 840 001	GR-3	ohne Anlauffring / without thrust ring	(102)	
				1863 869 010	35	Nadellager / Needle Bearing	(47)	

		CODE				
--	--	------	--	---	---	---

























MERCEDES-BENZ

Unimog 100-500						
UX 100H,UX 100M 409.100	09.96 -	OM602.981, OM602.989	 3000 951 785  3082 269 031  1878 600 501  3151 248 031	250 26 M250 250CD KZIS-0		

Unimog 550-900						
U 52, U 60, U 600,U 600L 421.141 421.128 421.162 421.140 421.129 421.163 U 60T, U 600T 421.133 421.132	01.77 - 05.88	OM616.911, OM616.931, OM616.915, OM616.932	 1882 231 131 #	250 G250		
	01.77 - 05.88		 1861 840 133 #	250 10 250TPZ		
			 1863 840 001	GR-3	ohne Anlauftring / without thrust ring	(102)
			 1888 893 001 #	225 24 DOT240	Chass. 002949 - Chass. 166589 enthält eine Kupplungsscheibe / This part number includes one clutch disc	(66)
			 1862 718 002 ▽#	240 10 240CC	Chass. 002949 - Chass. 166589 Lose Kupplungsscheibe / Loose clutch disc	(39)
			 1863 837 003	GR-4	Chass. 002949 - Chass. 166589 ohne Anlauftring / without thrust ring	(102)
			 1863 869 010	35	Nadellager / Needle Bearing	(47)
U 600 407.200	05.88 -	OM616.942, OM616.943	 1882 231 131 #	250 G250		
			 1861 840 133 #	250 10 250TPZ		
			 1863 840 001	GR-3	-> Chass. 166588 ohne Anlauftring / without thrust ring	(102)
			 1863 837 002	GR-4	Chass. 166589-> mit Anlauftring / with thrust ring	(88)
			 1888 893 001 #	225 24 DOT240	Chass. 002949 - Chass. 166589 enthält eine Kupplungsscheibe / This part number includes one clutch disc	(66)
			 1862 718 002 ▽#	240 10 240CC	Chass. 002949 - Chass. 166589 Lose Kupplungsscheibe / Loose clutch disc	(39)
			 1863 837 003	GR-4	Chass. 002949 - Chass. 166589 ohne Anlauftring / without thrust ring	(102)
 1863 869 010	35	Nadellager / Needle Bearing	(47)			
U 600 407.100	05.88 -	OM616.942, OM616.943	 1882 231 131 #	250 G250	für Fahrzeuge mit Einscheibenkupplung / for vehicles with single disc clutch	(71)
			 1861 840 133 #	250 10 250TPZ	für Fahrzeuge mit Einscheibenkupplung / for vehicles with single disc clutch	(71)
			 1863 840 001	GR-3	für Fahrzeuge mit Einscheibenkupplung / for vehicles with single disc clutch ohne Anlauftring / without thrust ring	(102)
			 1888 893 001 #	225 24 DOT240	-> Chass. 166588 enthält eine Kupplungsscheibe / This part number includes one clutch disc Sonderausführung / Special design	(66) (56)
			 1862 718 002 ▽#	240 10 240CC	-> Chass. 166588 Lose Kupplungsscheibe / Loose clutch disc Sonderausführung / Special design	(39) (56)
			 1863 837 003	GR-4	-> Chass. 166588 Sonderausführung / Special design ohne Anlauftring / without thrust ring	(56) (102)
			 1888 600 101 #	240 24 DOT240	Chass. 166590-> enthält eine Kupplungsscheibe / This part number includes one clutch disc	(66)
			 1862 718 002 #	240 10 240CC	Chass. 166590->	
			 1863 837 002	GR-4	Chass. 166590-> mit Anlauftring / with thrust ring	(88)
			 1863 855 000	GR-8	Chass. 166590-> mit Anlauftring / with thrust ring	(88)
			 1863 869 010	35	Nadellager / Needle Bearing	(47)



























		CODE				
--	--	------	--	---	---	---

MERCEDES-BENZ

Unimog 550-900						
U 650,U 650L 407.211 407.210	05.88-	OM616.942, OM616.943	 1882 231 131 #	250 G250	für Fahrzeuge mit Einscheibenkupplung / for vehicles with single disc clutch	(71)
			 1861 840 133 #	250 10 250TPZ	für Fahrzeuge mit Einscheibenkupplung / for vehicles with single disc clutch	(71)
			 1863 840 001	GR-3	-> Chass. 166588 für Fahrzeuge mit Einscheibenkupplung / for vehicles with single disc clutch ohne Anlauftring / without thrust ring	(71) (102)
			 1863 837 002	GR-4	Chass. 166589-> für Fahrzeuge mit Einscheibenkupplung / for vehicles with single disc clutch mit Anlauftring / with thrust ring	(71) (88)
			 1888 893 001 #	225 24 DOT240	-> Chass. 166588 enthält eine Kupplungsscheibe / This part number includes one clutch disc Sonderausführung / Special design	(66) (56)
			 1862 718 002 ▽#	240 10 240CC	-> Chass. 166588 Lose Kupplungsscheibe / Loose clutch disc Sonderausführung / Special design	(39) (56)
			 1863 837 003	GR-4	-> Chass. 166588 Sonderausführung / Special design ohne Anlauftring / without thrust ring	(56) (102)
			 1863 869 010	35	Nadellager / Needle Bearing	(47)
U 650,U 650L 407.111 407.110	05.88-	OM616.942, OM616.943	 1882 231 131 #	250 G250	für Fahrzeuge mit Einscheibenkupplung / for vehicles with single disc clutch	(71)
			 1861 840 133 #	250 10 250TPZ	für Fahrzeuge mit Einscheibenkupplung / for vehicles with single disc clutch	(71)
			 1863 840 001	GR-3	-> Chass. 166588 für Fahrzeuge mit Einscheibenkupplung / for vehicles with single disc clutch ohne Anlauftring / without thrust ring	(71) (102)
			 1863 837 002	GR-4	Chass. 166589-> für Fahrzeuge mit Einscheibenkupplung / for vehicles with single disc clutch mit Anlauftring / with thrust ring	(71) (88)
			 1888 893 001 #	225 24 DOT240	-> Chass. 166588 enthält eine Kupplungsscheibe / This part number includes one clutch disc Sonderausführung / Special design	(66) (56)
			 1862 718 002 ▽#	240 10 240CC	-> Chass. 166588 Lose Kupplungsscheibe / Loose clutch disc Sonderausführung / Special design	(39) (56)
			 1863 837 003	GR-4	-> Chass. 166588 Sonderausführung / Special design ohne Anlauftring / without thrust ring	(56) (102)
			 1888 600 101 #	240 24 DOT240	Chass. 166590-> enthält eine Kupplungsscheibe / This part number includes one clutch disc	(66)
			 1862 718 002 #	240 10 240CC	Chass. 166590->	
			 1863 837 002	GR-4	Chass. 166590-> mit Anlauftring / with thrust ring	(88)
			 1863 855 000	GR-8	Chass. 166590-> mit Anlauftring / with thrust ring	(88)
			 1863 869 010	35	Nadellager / Needle Bearing	(47)
U 800 416.140-163 416.114-117 416.135 416.134			 1888 877 101 #	280 DOT280	Chass. 000562 - Chass. 088736 enthält zwei Kupplungsscheiben / This part number includes both clutch discs	(67)
			 1888 877 102 #	280 24 DOT280	Chass. 088737 - Chass. 166589 enthält eine Kupplungsscheibe / This part number includes one clutch disc	(66)
			 1888 877 103 #	280 24 DOT280	Chass. 166590-> enthält eine Kupplungsscheibe / This part number includes one clutch disc	(66)
			 1861 966 141 ▽#	280 10 280GSPD CE/ CERAM	Lose Kupplungsscheibe / Loose clutch disc	(39)





















		CODE				
--	--	------	--	---	---	---

MERCEDES-BENZ

Unimog 550-900						
U 800,L 403.120-123				1888 877 101 #	280 DOT280	Chass. 000760 - Chass. 088736 enthält zwei Kupplungsscheiben / This part number includes both clutch discs (67)
				1888 877 102 #	280 24 DOT280	Chass. 088737-> enthält eine Kupplungsscheibe / This part number includes one clutch disc (66)
				1861 966 141 ▽#	280 10 280GSPD CE/ CERAM	Chass. 088737-> Lose Kupplungsscheibe / Loose clutch disc (39)
				1863 837 003	GR-4	Chass. 088737-> ohne Anlauftring / without thrust ring (102)
U 800 403.122 417.200	01.77 - 03.90	OM314.917		1882 229 131 #	280 G280	->Chass. 088736 403.122
				1861 518 031 #	280 10 280BDC	->Chass. 088736 403.122 Anzahl der Beläge / Number of pads: 6 (8)
				1861 611 131 ●#	280 10 280B/Z	->Chass. 088736 403.122
				1863 840 001	GR-3	->Chass. 088736 403.122 ohne Anlauftring / without thrust ring (102)
				3482 008 032	310 MF310	Chass. 088737-> 403.122
				1861 384 334 #	310 10 310GSZ	Chass. 088737-> 403.122
				1863 840 001	GR-3	Chass. 088737-> 403.122 ohne Anlauftring / without thrust ring (102)
				1888 893 001 #	225 24 DOT240	403.122 für Fahrzeuge mit Zweischeibenkupplung / for vehicles with double disc clutch enthält eine Kupplungsscheibe / This part number includes one clutch disc (77) (66)
				1862 718 002 ▽#	240 10 240CC	403.122 für Fahrzeuge mit Zweischeibenkupplung / for vehicles with double disc clutch Lose Kupplungsscheibe / Loose clutch disc (77) (39)
				1863 837 003	GR-4	403.122 für Fahrzeuge mit Zweischeibenkupplung / for vehicles with double disc clutch ohne Anlauftring / without thrust ring (77) (102)
				3482 008 032	310 MF310	417.200
				1861 384 334 #	310 10 310GSZ	417.200
				1863 840 001	GR-3	->Chass. 166589 417.200 ohne Anlauftring / without thrust ring (102)
				1863 837 002	GR-4	Chass. 166590-> 417.200 mit Anlauftring / with thrust ring (88)
U 800L 413.111 413.110	01.77 - 03.90	OM314.917		1882 229 131 #	280 G280	->Chass. 088736
				1861 518 031 #	280 10 280BDC	->Chass. 088736 Anzahl der Beläge / Number of pads: 6 (8)
				1861 611 131 ●#	280 10 280B/Z	->Chass. 088736
				1863 840 001	GR-3	->Chass. 088736 ohne Anlauftring / without thrust ring (102)
				3482 008 032	310 MF310	Chass. 088737->
				1861 384 334 #	310 10 310GSZ	Chass. 088737->
				1863 840 001	GR-3	Chass. 088737-> ohne Anlauftring / without thrust ring (102)
				1888 877 101 #	280 DOT280	->Chass. 088736 für Fahrzeuge mit Zweischeibenkupplung / for vehicles with double disc clutch enthält zwei Kupplungsscheiben / This part number includes both clutch discs (77) (67)
	1888 877 102 #	280 24 DOT280	Chass. 088737-> für Fahrzeuge mit Zweischeibenkupplung / for (77)			

























		CODE				
--	--	------	--	---	---	---

MERCEDES-BENZ

Unimog 550-900						
U 800 417.100	05.88-03.90	OM314.917	 3482 008 032	310 MF310		
			 1861 384 334 #	310 10 310GSZ		
			 1863 840 001	GR-3	-> Chass. 166589 ohne Anlauftring / without thrust ring	(102)
			 1863 837 002	GR-4	Chass. 166590-> mit Anlauftring / with thrust ring	(88)
			 1888 877 102 #	280 24 DOT280	-> Chass. 166589 enthält eine Kupplungsscheibe / This part number includes one clutch disc	(66)
			 1888 877 103 #	280 24 DOT280	Chass. 166590-> enthält eine Kupplungsscheibe / This part number includes one clutch disc	(66)
			 1861 966 141 ▽#	280 10 280GSPD CE/ CERAM	Lose Kupplungsscheibe / Loose clutch disc	(39)
U 900			 1888 067 042 #	330 22 DUT330/ 310	enthält eine Kupplungsscheibe / This part number includes one clutch disc	(66)
			 1861 741 042 ▽#	327 20 327GSDC	enthält Druckplattenbefestigungsschrauben / includes bolt for pressure plate mounting	(64)
			 1863 837 002	GR-4	Anzahl der Beläge / Number of pads: 8 Lose Kupplungsscheibe / Loose clutch disc	(8) (39)
			 1863 855 000	GR-8	mit Anlauftring / with thrust ring	(88)
U 900 416.135 416.140-163 416.114-117 416.134			 1888 877 101 #	280 DOT280	Chass. 000562 - Chass. 088736 enthält zwei Kupplungsscheiben / This part number includes both clutch discs	(67)
			 1888 877 102 #	280 24 DOT280	Chass. 088737 - Chass. 166589 enthält eine Kupplungsscheibe / This part number includes one clutch disc	(66)
			 1888 877 103 #	280 24 DOT280	Chass. 166590-> enthält eine Kupplungsscheibe / This part number includes one clutch disc	(66)
			 1861 966 141 ▽#	280 10 280GSPD CE/ CERAM		
U 900 406.145			 1882 282 331	310 GFX310	Chass. 003773 - Chass. 088736 Nur bei Alteil-Rückgabe lieferbar (Reparatur; Werk Bielefeld) / Please return old unit for repair (plant Bielefeld)	(49)
			 1861 384 334 #	310 10 310GSZ	Chass. 003773 - Chass. 088736	
			 1863 840 001	GR-3	Chass. 003773 - Chass. 088736 ohne Anlauftring / without thrust ring	(102)
U 900 406.120			 1888 893 001 #	225 24 DOT240	enthält eine Kupplungsscheibe / This part number includes one clutch disc	(66)
			 1862 718 002 ▽#	240 10 240CC	Lose Kupplungsscheibe / Loose clutch disc	(39)
			 1863 837 003	GR-4	ohne Anlauftring / without thrust ring	(102)



























		CODE				
--	--	------	--	---	---	---

MERCEDES-BENZ

Unimog 550-900							
U 900 417.201 406.120/121 417.101	01.77 -	OM353.902		1882 229 131 #	280 G280	-> Chass. 088736 406.120-121	
				1861 518 031 #	280 10 280BDC	-> Chass. 088736 406.120-121 Anzahl der Beläge / Number of pads: 6	(8)
				1861 611 131 ●#	280 10 280B/Z	-> Chass. 088736 406.120-121	
				1863 840 001	GR-3	-> Chass. 088736 406.120-121 ohne Anlauftring / without thrust ring	(102)
				3482 008 032	310 MF310	Chass. 088737-> 406.120-121	
				1861 384 334 #	310 10 310GSZ	Chass. 088737-> 406.120-121	
				1863 840 001	GR-3	Chass. 088737-> 406.120-121 ohne Anlauftring / without thrust ring	(102)
				1888 877 101 #	280 DOT280	Chass. 009059 - Chass. 088736 406.120-121 enthält zwei Kupplungsscheiben / This part number includes both clutch discs	(67)
				1888 877 102 #	280 24 DOT280	Chass. 088737-> 406.120-121 enthält eine Kupplungsscheibe / This part number includes one clutch disc	(66)
				1861 966 141 ▽#	280 10 280GSPD CE/ CERAM	Chass. 088737-> 406.120-121 Lose Kupplungsscheibe / Loose clutch disc	(39)
				1863 837 003	GR-4	Chass. 088737-> 406.120-121 ohne Anlauftring / without thrust ring	(102)
				3482 008 032	310 MF310	417.101/201	
				1861 384 334 #	310 10 310GSZ	417.101/201	
				1863 840 001	GR-3	-> Chass. 166588 417.101/201 ohne Anlauftring / without thrust ring	(102)
				1863 837 002	GR-4	Chass. 166589-> 417.101/201 mit Anlauftring / with thrust ring	(88)
U 900 417.101 U 900 417.106	05.88 -	OM353.902, OM366.939, OM356.912		3482 008 032	310 MF310		
	11.88 -			1861 384 334 #	310 10 310GSZ		
				1863 840 001	GR-3	ohne Anlauftring / without thrust ring	(102)
				1888 877 102 #	280 24 DOT280	-> Chass. 166589 enthält eine Kupplungsscheibe / This part number includes one clutch disc	(66)
				1888 877 103 #	280 24 DOT280	Chass. 166590-> enthält eine Kupplungsscheibe / This part number includes one clutch disc	(66)
		1861 966 141 ▽#	280 10 280GSPD CE/ CERAM	Lose Kupplungsscheibe / Loose clutch disc	(39)		
U 900 406.143 406.142	01.77 - 01.88	OM353.940		1882 282 331	310 GFX310	Nur bei Alteil-Rückgabe lieferbar (Reparatur; Werk Bielefeld) / Please return old unit for repair (plant Bielefeld)	(49)
				1861 384 334 #	310 10 310GSZ		
				1863 840 001	GR-3	ohne Anlauftring / without thrust ring	(102)























		CODE					
--	--	------	--	--	---	---	---

MERCEDES-BENZ

Unimog 1000-1350							
U 1000 424.121	01.77 - 05.88	OM353.962		3482 008 032	310 MF310		
				1861 603 034 #	310 20 310GSZ		
				3151 051 031	KZI-4		
				1888 067 042 #	330 22 DUT330/ 310	enthält eine Kupplungsscheibe / This part number includes one clutch disc enthält Druckplattenbefestigungsschrauben / includes bolt for pressure plate mounting	(66) (64)
				1861 741 042 ▽#	327 20 327GSDC	Anzahl der Beläge / Number of pads: 8 Lose Kupplungsscheibe / Loose clutch disc	(8) (39)
				1863 837 002	GR-4	mit Anlauftring / with thrust ring	(88)
				1863 855 000	GR-8	mit Anlauftring / with thrust ring	(88)
				1888 893 001 #	225 24 DOT240	enthält eine Kupplungsscheibe / This part number includes one clutch disc	(66)
				1862 718 002 ▽#	240 10 240CC	Lose Kupplungsscheibe / Loose clutch disc	(39)
				1863 837 003	GR-4	ohne Anlauftring / without thrust ring	(102)
U 1000 427.100	01.88 -	OM356.914, OM366.915		3482 008 038	310 MF310		
				1861 603 034 #	310 20 310GSZ		
				3151 051 031	KZI-4	->Chass. 173809	
				3182 002 131	HHIS-3	Chass. 173810-> Immer erneuern / Renew everytime	(28)
				1888 067 031 #	330 24 DUT330	enthält eine Kupplungsscheibe / This part number includes one clutch disc Sonderausführung / Special design	(66) (56)
				1888 998 201 #	330 24 DUT330	für Fahrzeuge mit Niederdruck-Bremsanlage / for vehicles with low-pressure brakesystem enthält eine Kupplungsscheibe / This part number includes one clutch disc Sonderausführung / Special design	(74) (66) (56)
				1861 741 042 ▽#	327 20 327GSDC	Anzahl der Beläge / Number of pads: 8 Lose Kupplungsscheibe / Loose clutch disc Sonderausführung / Special design	(8) (39) (56)
				1863 837 002	GR-4	mit Anlauftring / with thrust ring	(88)
				1863 855 000	GR-8	mit Anlauftring / with thrust ring	(88)
U 1000T 424.131	01.77 - 12.82	OM353.940, OM353.980		3482 008 032	310 MF310		
				1861 603 034 #	310 20 310GSZ		
				3151 051 031	KZI-4		
				1888 067 042 #	330 22 DUT330/ 310	enthält eine Kupplungsscheibe / This part number includes one clutch disc enthält Druckplattenbefestigungsschrauben / includes bolt for pressure plate mounting	(66) (64)
				1861 741 042 ▽#	327 20 327GSDC	Anzahl der Beläge / Number of pads: 8 Lose Kupplungsscheibe / Loose clutch disc	(8) (39)
				1863 837 002	GR-4	mit Anlauftring / with thrust ring	(88)
				1863 855 000	GR-8	mit Anlauftring / with thrust ring	(88)

		CODE				
--	--	------	--	---	---	---

MERCEDES-BENZ

Unimog 1000-1350						
U 100, U 110, U 1100L 416.116 416.141 416.140 416.115 416.160 416.117	01.77-05.88	OM353.940, OM353.901, OM353.980	 1882 231 131 #	250 G250	416.140-141	
			 1861 840 133 #	250 10 250TPZ	416.140-141	
			 1863 840 001	GR-3	416.140-141 ohne Anlauftring / without thrust ring	(102)
			 1882 282 331	310 GFX310	->Chass. 088736 für Fahrzeuge mit Einscheibenkupplung / for vehicles with single disc clutch Nur bei Altteil-Rückgabe lieferbar (Reparatur; Werk Bielefeld) / Please return old unit for repair (plant Bielefeld)	(71) (49)
			 1861 384 334 #	310 10 310GSZ	->Chass. 088736 für Fahrzeuge mit Einscheibenkupplung / for vehicles with single disc clutch	(71)
			 1863 840 001	GR-3	->Chass. 088736 für Fahrzeuge mit Einscheibenkupplung / for vehicles with single disc clutch ohne Anlauftring / without thrust ring	(71) (102)
			 3482 008 032	310 MF310	Chass. 088737-> für Fahrzeuge mit Einscheibenkupplung / for vehicles with single disc clutch	(71)
			 1861 384 334 #	310 10 310GSZ	Chass. 088737-> für Fahrzeuge mit Einscheibenkupplung / for vehicles with single disc clutch	(71)
			 1863 840 001	GR-3	Chass. 088737-> für Fahrzeuge mit Einscheibenkupplung / for vehicles with single disc clutch ohne Anlauftring / without thrust ring	(71) (102)
			 1888 877 101 #	280 DOT280	Chass. 000562 - Chass. 088736 enthält zwei Kupplungsscheiben / This part number includes both clutch discs	(67)
			 1888 877 102 #	280 24 DOT280	Chass. 088737 - Chass. 166589 enthält eine Kupplungsscheibe / This part number includes one clutch disc	(66)
			 1888 877 103 #	280 24 DOT280	Chass. 166590-> enthält eine Kupplungsscheibe / This part number includes one clutch disc	(66)
			 1861 966 141 ▽#	280 10 280GSPD CE/ CERAM	Lose Kupplungsscheibe / Loose clutch disc	(39)
			U 125, U 1100L 416.114 416.162/163	01.77-01.88	OM353.907	 1882 282 331
 1861 384 334 #	310 10 310GSZ	->Chass. 088736 für Fahrzeuge mit Einscheibenkupplung / for vehicles with single disc clutch				(71)
 1863 840 001	GR-3	->Chass. 088736 für Fahrzeuge mit Einscheibenkupplung / for vehicles with single disc clutch ohne Anlauftring / without thrust ring				(71) (102)
 3482 008 032	310 MF310	Chass. 088737-> für Fahrzeuge mit Einscheibenkupplung / for vehicles with single disc clutch				(71)
 1861 384 334 #	310 10 310GSZ	Chass. 088737-> für Fahrzeuge mit Einscheibenkupplung / for vehicles with single disc clutch				(71)
 1863 840 001	GR-3	Chass. 088737-> für Fahrzeuge mit Einscheibenkupplung / for vehicles with single disc clutch ohne Anlauftring / without thrust ring				(71) (102)
 1888 877 101 #	280 DOT280	Chass. 000562 - Chass. 088736 enthält zwei Kupplungsscheiben / This part number includes both clutch discs				(67)
 1888 877 102 #	280 24 DOT280	Chass. 088737 - Chass. 166589 enthält eine Kupplungsscheibe / This part number includes one clutch disc				(66)
 1888 877 103 #	280 24 DOT280	Chass. 166590-> enthält eine Kupplungsscheibe / This part number includes one clutch disc				(66)
 1861 966 141 ▽#	280 10 280GSPD	Lose Kupplungsscheibe / Loose clutch disc				(39)

		CODE				
--	--	------	--	---	---	---





























MERCEDES-BENZ

Unimog 1000-1350

U 100, U 110T, U 1100T 416.134/135 417.000	01.77-	OM353.940, OM353.901, OM353.980	 3482 008 032	310 MF310	417.000 für Fahrzeuge mit Einscheibenkupplung / for vehicles with single disc clutch	(71)
			 1861 384 334 #	310 10 310GSZ	417.000 für Fahrzeuge mit Einscheibenkupplung / for vehicles with single disc clutch	(71)
			 1863 840 001	GR-3	-> Chass. 166589 417.000 für Fahrzeuge mit Einscheibenkupplung / for vehicles with single disc clutch ohne Anlauftring / without thrust ring	(71) (102)
			 1863 837 002	GR-4	Chass. 166590-> 417.000 für Fahrzeuge mit Einscheibenkupplung / for vehicles with single disc clutch mit Anlauftring / with thrust ring	(71) (88)
			 1888 877 102 #	280 24 DOT280	-> Chass. 166589 417.000 enthält eine Kupplungsscheibe / This part number includes one clutch disc	(66)
			 1888 877 103 #	280 24 DOT280	Chass. 166590-> 417.000 enthält eine Kupplungsscheibe / This part number includes one clutch disc	(66)
			 1861 966 141 ▽#	280 10 280GSPD CE/ CERAM	417.000 Lose Kupplungsscheibe / Loose clutch disc	(39)
			 1882 229 131 #	280 G280	-> Chass. 088736 416.134-135 für Fahrzeuge mit Einscheibenkupplung / for vehicles with single disc clutch	(71)
			 1861 518 031 #	280 10 280BDC	-> Chass. 088736 416.134-135 für Fahrzeuge mit Einscheibenkupplung / for vehicles with single disc clutch Anzahl der Beläge / Number of pads: 6	(71) (8)
			 1861 611 131 ●#	280 10 280B/Z	-> Chass. 088736 416.134-135 für Fahrzeuge mit Einscheibenkupplung / for vehicles with single disc clutch	(71)
			 1863 840 001	GR-3	-> Chass. 088736 416.134-135 für Fahrzeuge mit Einscheibenkupplung / for vehicles with single disc clutch ohne Anlauftring / without thrust ring	(71) (102)
			 3482 008 032	310 MF310	Chass. 088737-> 416.134-135 für Fahrzeuge mit Einscheibenkupplung / for vehicles with single disc clutch	(71)
			 1861 384 334 #	310 10 310GSZ	Chass. 088737-> 416.134-135 für Fahrzeuge mit Einscheibenkupplung / for vehicles with single disc clutch	(71)
			 1863 840 001	GR-3	Chass. 088737-> 416.134-135 für Fahrzeuge mit Einscheibenkupplung / for vehicles with single disc clutch ohne Anlauftring / without thrust ring	(71) (102)
			 1888 877 101 #	280 DOT280	Chass. 000562 - Chass. 088736 416.134-135 enthält zwei Kupplungsscheiben / This part number includes both clutch discs	(67)
			 1888 877 102 #	280 24 DOT280	Chass. 088737 - Chass. 166589 416.134-135 enthält eine Kupplungsscheibe / This part number includes one clutch disc	(66)
			 1888 877 103 #	280 24 DOT280	Chass. 166590-> 416.134-135 enthält eine Kupplungsscheibe / This part number includes one clutch disc	(66)
			 1861 966 141 ▽#	280 10 280GSPD CE/ CERAM	416.134-135 Lose Kupplungsscheibe / Loose clutch disc	(39)

















		CODE				
--	--	------	--	---	---	---

MERCEDES-BENZ

Unimog 1000-1350						
U 1150L 417.212 U 1150,U 1150L 417.110/111 417.120 417.115/116 U 1150,U 1150L 417.210 417.220 417.211	05.88-	OM353.940, OM353.907		3482 008 032	310 MF310	für Fahrzeuge mit Einscheibenkupplung / for vehicles with single disc clutch (71)
	05.88-			1861 384 334 #	310 10 310GSZ	für Fahrzeuge mit Einscheibenkupplung / for vehicles with single disc clutch (71)
	05.88-			1863 840 001	GR-3	-> Chass. 166589 für Fahrzeuge mit Einscheibenkupplung / for vehicles with single disc clutch ohne Anlauftring / without thrust ring (71)
				1863 837 002	GR-4	Chass. 166590-> für Fahrzeuge mit Einscheibenkupplung / for vehicles with single disc clutch mit Anlauftring / with thrust ring (71)
				1888 877 102 #	280 24 DOT280	-> Chass. 166589 enthält eine Kupplungsscheibe / This part number includes one clutch disc (66)
				1888 877 103 #	280 24 DOT280	Chass. 166590-> enthält eine Kupplungsscheibe / This part number includes one clutch disc (66)
				1861 966 141 ▽#	280 10 280GSPD CE/ CERAM	Lose Kupplungsscheibe / Loose clutch disc (39)
U 1200 424.122 U 1200T 424.132 U 1250 424.127 424.126	02.82 - 05.88	OM353.973, OM353.995		3482 012 237	330 GMF330	
	01.83 - 05.88			1861 667 034	330 20 330GSB	
	12.84 - 05.88			3151 051 031	KZI-4	
				1888 067 042 #	330 22 DUT330/ 310	enthält eine Kupplungsscheibe / This part number includes one clutch disc (66)
				1861 741 042 ▽#	327 20 327GSDC	Anzahl der Beläge / Number of pads: 8 Lose Kupplungsscheibe / Loose clutch disc (8) (39)
				1863 837 002	GR-4	mit Anlauftring / with thrust ring (88)
				1863 855 000	GR-8	mit Anlauftring / with thrust ring (88)
U 1200 427.101 U 1200T 427.000 U 1250,U 1250L 427.110/111 U 1250L 427.111	01.88-	OM356.950, OM356.954, OM366.955, OM366.949		3482 012 237	330 GMF330	
	01.88-			1861 667 034	330 20 330GSB	
	01.88-			3151 051 031	KZI-4	-> Chass. 173809
	05.88-			3182 002 131	HHIS-3	Chass. 173810-> Immer erneuern / Renew everytime (28)
				3800 710 002 #  1888 067 031  1861 741 042  3182 003 131	330 20 DUT330 327GSDC HHIS-3	Sonderausführung / Special design (56)
				1888 998 201 #	330 24 DUT330	für Fahrzeuge mit Niederdruck-Bremsanlage / for vehicles with low-pressure brakesystem enthält eine Kupplungsscheibe / This part number includes one clutch disc (74) (66)
				1861 741 042 ▽#	327 20 327GSDC	Anzahl der Beläge / Number of pads: 8 Lose Kupplungsscheibe / Loose clutch disc Sonderausführung / Special design (8) (39) (56)
				3182 003 131	HHIS-3	Sonderausführung / Special design Immer erneuern / Renew everytime (56) (28)
				3482 012 237	330 GMF330	
U 1300,L 425.121 425.110 425.120 425.141 425.131 U 1300,L 435.121 435.141 435.110 435.120 435.113 435.117 435.131				1861 667 034	330 20 330GSB	
				3151 051 031	KZI-4	
				3482 012 237	330 GMF330	

MERCEDES-BENZ

Unimog 1000-1350

U 1300 425.121	01.77 - 12.84	OM353.973, OM353.995	 3482 012 211	330 GMF330	->Chass. 001570	
			 1861 594 034 #	330 20 330GSZ	->Chass. 001570	
			 3151 051 031	KZI-4	->Chass. 001570	
			 3482 012 237	330 GMF330	Chass. 001571->	
			 1861 667 034	330 20 330GSB	Chass. 001571->	
			 3151 051 031	KZI-4	Chass. 001571->	
			 1888 893 001 #	225 24 DOT240	enthält eine Kupplungsscheibe / This part number includes one clutch disc	(66)
			 1862 718 002 ▽#	240 10 240CC	Lose Kupplungsscheibe / Loose clutch disc	(39)
			 1863 837 003	GR-4	ohne Anlauftring / without thrust ring	(102)
			 1888 067 042 #	330 22 DUT330/ 310	enthält eine Kupplungsscheibe / This part number includes one clutch disc enthält Druckplattenbefestigungsschrauben / includes bolt for pressure plate mounting	(66) (64)
			 1861 741 042 ▽#	327 20 327GSDC	Anzahl der Beläge / Number of pads: 8 Lose Kupplungsscheibe / Loose clutch disc	(8) (39)
			 1863 837 002	GR-4	mit Anlauftring / with thrust ring	(88)
			 1863 855 000	GR-8	mit Anlauftring / with thrust ring	(88)
U 1300 L 436.326 436.325	01.77 - 05.88	OM382.917	 3482 002 234	350 GMF350X		
			 1861 956 133	350 20 350GTD		
			 1861 713 133 ●#	350 20 350GSZ		
			 3151 051 031	KZI-4		

























		CODE				
--	--	------	--	---	---	---

MERCEDES-BENZ

Unimog 1000-1350

U 1300,U 1300L
436.320 435.115 425.121
435.117 436.321













01.77 - 05.88 OM353.973,
OM353.961

	3482 012 211	330 GMF330	->Chass. 001570 425.121	
	1861 594 034 #	330 20 330GSZ	->Chass. 001570 425.121	
	3151 051 031	KZI-4	->Chass. 001570 425.121	
	3482 012 237	330 GMF330	Chass. 001571-> 425.121	
	1861 667 034	330 20 330GSB	Chass. 001571-> 425.121	
	3151 051 031	KZI-4	Chass. 001571-> 425.121	
	1888 893 001 #	225 24 DOT240	425.121 enthält eine Kupplungsscheibe / This part number includes one clutch disc	(66)
	1862 718 002 ▽#	240 10 240CC	425.121 Lose Kupplungsscheibe / Loose clutch disc	(39)
	1863 837 003	GR-4	425.121 ohne Anlauftring / without thrust ring	(102)
	1888 067 042 #	330 22 DUT330/ 310	425.121 enthält eine Kupplungsscheibe / This part number includes one clutch disc enthält Druckplattenbefestigungsschrauben / includes bolt for pressure plate mounting	(66) (64)
	1861 741 042 ▽#	327 20 327GSDC	425.121 Anzahl der Beläge / Number of pads: 8 Lose Kupplungsscheibe / Loose clutch disc	(8) (39)
	1863 837 002	GR-4	425.121 mit Anlauftring / with thrust ring	(88)
	1863 855 000	GR-8	425.121 mit Anlauftring / with thrust ring	(88)
	3482 012 211	330 GMF330	->Chass. 002154 435.115/117	
	1861 594 034 #	330 20 330GSZ	->Chass. 002154 435.117	
	3482 012 237	330 GMF330	Chass. 002155-> 435.117	
	1861 667 034	330 20 330GSB	Chass. 002155-> 435.117	
	3151 051 031	KZI-4	435.117	
	1888 067 042 #	330 22 DUT330/ 310	435.117 enthält eine Kupplungsscheibe / This part number includes one clutch disc enthält Druckplattenbefestigungsschrauben / includes bolt for pressure plate mounting	(66) (64)
	1861 741 042 ▽#	327 20 327GSDC	435.117 Anzahl der Beläge / Number of pads: 8 Lose Kupplungsscheibe / Loose clutch disc	(8) (39)
	1863 837 002	GR-4	435.117 mit Anlauftring / with thrust ring	(88)
	1863 855 000	GR-8	435.117 mit Anlauftring / with thrust ring	(88)
	3482 012 237	330 GMF330	436.320-321	
	1861 667 034	330 20 330GSB	436.320-321	
	3151 051 031	KZI-4	436.320-321	









		CODE				
--	--	------	--	---	---	---

MERCEDES-BENZ

Unimog 1000-1350





























U 1350L 437.110	05.88-	OM366.955	 3482 012 237	330 GMF330		
			 1861 667 034	330 20 330GSB		
			 3151 051 031	KZI-4	->Chass. 173809	
			 3182 002 131	HHIS-3	Chass. 173810-> Immer erneuern / Renew everytime	(28)
			 3800 710 002 #  1888 067 031  1861 741 042  3182 003 131	330 20 DUT330 327GSDC HHIS-3	Sonderausführung / Special design	(56)
			 1861 594 034 ●▽#	330 20 330GSZ	Lose Kupplungsscheibe / Loose clutch disc Sonderausführung / Special design	(39) (56)
			 1888 998 902 ●#	350 24 DUT350/ 330	enthält eine Kupplungsscheibe / This part number includes one clutch disc Sonderausführung / Special design	(66) (56)
			 1862 962 002 ▽#	350 20 350GSDC	Lose Kupplungsscheibe / Loose clutch disc Sonderausführung / Special design	(39) (56)
			 3182 003 131	HHIS-3	Sonderausführung / Special design Immer erneuern / Renew everytime	(56) (28)

Unimog 1400-1750

U 1400 437.110 U 1450 437.110 U 1600,L 437.110			 1888 067 031 #	330 24 DUT330	enthält eine Kupplungsscheibe / This part number includes one clutch disc Sonderausführung / Special design	(66) (56)
			 1861 741 042 ●▽#	327 20 327GSDC	Anzahl der Beläge / Number of pads: 8 Lose Kupplungsscheibe / Loose clutch disc Sonderausführung / Special design	(8) (39) (56)
			 1861 594 034 ▽#	330 20 330GSZ	Lose Kupplungsscheibe / Loose clutch disc Sonderausführung / Special design	(39) (56)
			 1888 998 902 ●#	350 24 DUT350/ 330	enthält eine Kupplungsscheibe / This part number includes one clutch disc Sonderausführung / Special design	(66) (56)
			 1862 962 002 ▽#	350 20 350GSDC	Lose Kupplungsscheibe / Loose clutch disc Sonderausführung / Special design	(39) (56)
			U 1400 424.122 424.132 424.126/127 U 1450 424.126/127 424.132 424.122 U 1500 435.117 435.120/121 435.131 435.141 435.110 435.113 U 1700,U 1700L 425.131 425.110 425.141 425.121 425.120			 3482 012 237
 1861 667 034	330 20 330GSB					
 3151 051 031	KZI-4					































		CODE					
--	--	------	--	--	---	---	---

MERCEDES-BENZ

Unimog 1400-1750							
U 1400 427.102 U 1450,U 1450L 427.112 427.111	01.88-	OM357.912, OM366.948, OM366.955, OM366.956, OM366.947		3482 012 237	330 GMF330		
	01.88-			1861 667 034	330 20 330GSB		
				3151 051 031	KZI-4	-> Chass. 173809	
				3182 002 131	HHIS-3	Chass. 173810-> Immer erneuern / Renew everytime	(28)
				3482 106 133	350 GMF350X		
				1861 956 133	350 20 350GTD		
				1861 713 133 ●#	350 20 350GSZ		
				3182 002 131	HHIS-3	Immer erneuern / Renew everytime	(28)
				3800 710 002 #  1888 067 031  1861 741 042  3182 003 131	330 20 DUT330 327GSDC HHIS-3	Sonderausführung / Special design	(56)
				1888 998 201 #	330 24 DUT330	für Fahrzeuge mit Niederdruck-Bremsanlage / for vehicles with low-pressure brakesystem enthält eine Kupplungsscheibe / This part number includes one clutch disc Sonderausführung / Special design	(74) (66) (56)
				1861 594 034 ▽#	330 20 330GSZ	Lose Kupplungsscheibe / Loose clutch disc Sonderausführung / Special design	(39) (56)
				1861 741 042 ●▽#	327 20 327GSDC	Anzahl der Beläge / Number of pads: 8 Lose Kupplungsscheibe / Loose clutch disc Sonderausführung / Special design	(8) (39) (56)
				3182 003 131	HHIS-3	Sonderausführung / Special design Immer erneuern / Renew everytime	(56) (28)
				3800 710 003 ●#  1888 998 902  1862 962 002  3182 003 131	350 20 DUT350/330 350GSDC HHIS-3	Sonderausführung / Special design	(56)
	U 1500 425.141 U 1500T 425.131 U 1550 424.126 U 1550 L 424.127		01.77 - 05.88	OM353.958, OM353.995, OM353.961		3482 012 237	330 GMF330
01.77 - 05.88			1861 667 034		330 20 330GSB	für Fahrzeuge mit Einscheibenkupplung / for vehicles with single disc clutch	(71)
01.86 - 05.88			3151 051 031		KZI-4	für Fahrzeuge mit Einscheibenkupplung / for vehicles with single disc clutch	(71)
02.86 - 05.88			1888 067 042 #		330 22 DUT330/ 310	enthält eine Kupplungsscheibe / This part number includes one clutch disc enthält Druckplattenbefestigungsschrauben / includes bolt for pressure plate mounting	(66) (64)
			1861 741 042 ▽#		327 20 327GSDC	Anzahl der Beläge / Number of pads: 8 Lose Kupplungsscheibe / Loose clutch disc	(8) (39)
			1863 837 002		GR-4	mit Anlaufring / with thrust ring	(88)
		1863 855 000	GR-8	mit Anlaufring / with thrust ring	(88)		
U 1550L 437.000-160 U 1550L/37 437.120 437.125				1888 998 902 #	350 24 DUT350/ 330	enthält eine Kupplungsscheibe / This part number includes one clutch disc	(66)
				1862 962 002 ▽#	350 20 350GSDC	Lose Kupplungsscheibe / Loose clutch disc	(39)































		CODE				
--	--	------	--	---	---	---

MERCEDES-BENZ

Unimog 1400-1750						
U 1550L 437.120 437.111 U 1550L 437.111	05.88-	OM356.956, OM366.955, OM366.956		3482 002 234	350 GMF350X	->Chass. 173809
	05.88-			3482 106 133	350 GMF350X	Chass. 173810->
				1861 956 133	350 20 350GTD	
				1861 713 133 ●#	350 20 350GSZ	
				3151 051 031	KZI-4	->Chass. 173809
				3182 002 131	HHIS-3	Chass. 173810-> Immer erneuern / Renew everytime (28)
				1888 998 902 #	350 24 DUT350/ 330	enthält eine Kupplungsscheibe / This part number includes one clutch disc Sonderausführung / Special design (66)
				1862 962 002 ▽#	350 20 350GSDC	Lose Kupplungsscheibe / Loose clutch disc Sonderausführung / Special design (39) (56)
				1863 855 000	GR-8	->Chass. 186921 Sonderausführung / Special design mit Anlauftring / with thrust ring (56) (88)
				1863 837 002	GR-4	->Chass. 186921 Sonderausführung / Special design mit Anlauftring / with thrust ring (56) (88)
				3800 710 003 #  1888 998 902  1862 962 002  3182 003 131	350 20 DUT350/330 350GSDC HHIS-3	Chass. 186922->
			U 1550L 437.120 437.125 437.123 437.141	01.92-	OM356.955, OM356.956	
	3482 106 031	360 GMF350X				Chass. 173810-> 437.120/125
	1862 286 031 #	360 20 360GSDC				437.125/120
	3151 051 031	KZI-4				->Chass. 173809 437.120/125
	3182 002 131	HHIS-3				Chass. 173810-> 437.120/125 Immer erneuern / Renew everytime (28)
	1888 998 902 #	350 24 DUT350/ 330				437.120/125/123 enthält eine Kupplungsscheibe / This part number includes one clutch disc Sonderausführung / Special design (66)
	1862 962 002 ▽#	350 20 350GSDC				437.120/125/123 Lose Kupplungsscheibe / Loose clutch disc Sonderausführung / Special design (39) (56)
	1863 837 002	GR-4				->Chass. 186921 437.120/125/123 Sonderausführung / Special design mit Anlauftring / with thrust ring (56) (88)
	1863 855 000	GR-8				->Chass. 186921 437.120/125/123 Sonderausführung / Special design mit Anlauftring / with thrust ring (56) (88)
	3800 710 003 #  1888 998 902  1862 962 002  3182 003 131	350 20 DUT350/330 350GSDC HHIS-3				Chass. 186922-> 437.120/125/123 Sonderausführung / Special design (56)
	3482 106 133	350 GMF350X				437.123/141
	1861 956 133	350 20 350GTD				437.123/141
	1861 713 133 ●#	350 20 350GSZ				437.123/141
	3182 002 131	HHIS-3				437.123/141 Immer erneuern / Renew everytime (28)

































		CODE				
--	--	------	--	---	---	---

MERCEDES-BENZ

Unimog 1400-1750						
U 1550L 437.120 437.111 437.123	01.92-	OM366.963	 3482 002 234	350 GMF350X	->Chass. 173809 437.111/120	
			 3482 106 133	350 GMF350X	Chass. 173810-> 437.111/120	
			 1861 956 133	350 20 350GTD	437.111/120	
			 1861 713 133 ●#	350 20 350GSZ	437.111/120	
			 3151 051 031	KZI-4	->Chass. 173809 437.111/120	
			 3182 002 131	HHIS-3	Chass. 173810-> 437.111/120 Immer erneuern / Renew everytime	(28)
			 1888 998 902 #	350 24 DUT350/ 330	437.111/120 enthält eine Kupplungsscheibe / This part number includes one clutch disc Sonderausführung / Special design	(66) (56)
			 1862 962 002 ▽#	350 20 350GSDC	437.111/120 Lose Kupplungsscheibe / Loose clutch disc Sonderausführung / Special design	(39) (56)
			 1863 855 000	GR-8	->Chass. 186921 437.111/120 Sonderausführung / Special design mit Anlauftring / with thrust ring	(56) (88)
			 1863 837 002	GR-4	->Chass. 186921 437.111/120 Sonderausführung / Special design mit Anlauftring / with thrust ring	(56) (88)
			 3800 710 003 #  1888 998 902  1862 962 002  3182 003 131	350 20 DUT350/330 350GSDC HHIS-3	Chass. 186922-> 437.111/120	
			 3482 106 133	350 GMF350X	437.123	
			 1861 956 133	350 20 350GTD	437.123	
			 1861 713 133 ●#	350 20 350GSZ	437.123	
			 3182 002 131	HHIS-3	437.123 Immer erneuern / Renew everytime	(28)
			 3800 710 003 #  1888 998 902  1862 962 002  3182 003 131	350 20 DUT350/330 350GSDC HHIS-3	437.123	
			U 1550L 437.125 437.116 U 1550L 437.116 437.125	05.88-	OM356.980, OM357.924, OM366.984, OM357.945, OM356.997	 3482 002 239 #
05.88-	 3482 106 031	360 GMF350X		Chass. 173810->		
	 1862 286 031 #	360 20 360GSDC				
	 3151 051 031	KZI-4		->Chass. 173809		
	 3182 002 131	HHIS-3		Chass. 173810-> Immer erneuern / Renew everytime		(28)
	 3800 710 003 #  1888 998 902  1862 962 002  3182 003 131	350 20 DUT350/330 350GSDC HHIS-3		Sonderausführung / Special design		(56)





































		CODE		 Parameter		
--	--	------	--	---	---	---

MERCEDES-BENZ

Unimog 1400-1750						
U 1600 427.105	01.88-	OM356.956, OM366.949	 3482 002 234	350 GMF350X	->Chass. 173809	
			 3482 106 133	350 GMF350X	Chass. 173810->	
			 1861 956 133	350 20 350GTD		
			 1861 713 133 ●#	350 20 350GSZ		
			 3151 051 031	KZI-4	->Chass. 173809	
			 3182 002 131	HHIS-3	Chass. 173810-> Immer erneuern / Renew everytime	(28)
			 3800 710 002 #  1888 067 031  1861 741 042  3182 003 131	330 20 DUT330 327GSDC HHIS-3	Sonderausführung / Special design	(56)
			 1888 998 201 #	330 24 DUT330	für Fahrzeuge mit Niederdruck-Bremsanlage / for vehicles with low-pressure brakesystem enthält eine Kupplungsscheibe / This part number includes one clutch disc Sonderausführung / Special design	(74) (66) (56)
			 1861 741 042 ▽#	327 20 327GSDC	Anzahl der Beläge / Number of pads: 8 Lose Kupplungsscheibe / Loose clutch disc Sonderausführung / Special design	(8) (39) (56)
			 3182 003 131	HHIS-3	Sonderausführung / Special design Immer erneuern / Renew everytime	(56) (28)
			 3800 710 003 ●#  1888 998 902  1862 962 002  3182 003 131	350 20 DUT350/330 350GSDC HHIS-3	Sonderausführung / Special design	(56)
			U 1600 427.107 U 1600 427.107	09.89- 05.91-	OM356.980, OM357.924, OM366.984, OM357.945, OM356.997	 3482 002 239 #
 3482 106 031	360 GMF350X	Chass. 173810->				
 1862 286 031 #	360 20 360GSDC					
 3182 002 131	HHIS-3	Chass. 173810-> Immer erneuern / Renew everytime				(28)
 3151 051 031	KZI-4	->Chass. 173809				
 1888 998 901 ▲#	350 24 DUT350/ 330	enthält eine Kupplungsscheibe / This part number includes one clutch disc Sonderausführung / Special design				(66) (56)
 1878 992 401 ▽#	350 20 350GSDC	Anzahl der Beläge / Number of pads: 8 Lose Kupplungsscheibe / Loose clutch disc Sonderausführung / Special design				(8) (39) (56)
 1888 998 902 #	350 24 DUT350/ 330	enthält eine Kupplungsscheibe / This part number includes one clutch disc Sonderausführung / Special design				(66) (56)
 1862 962 002 ▽#	350 20 350GSDC	Lose Kupplungsscheibe / Loose clutch disc Sonderausführung / Special design				(39) (56)
 1863 837 002	GR-4	->Chass. 186921 Sonderausführung / Special design mit Anlauftring / with thrust ring				(56) (88)
 1863 855 000	GR-8	->Chass. 186921 Sonderausführung / Special design mit Anlauftring / with thrust ring				(56) (88)
 3800 710 003 #  1888 998 902  1862 962 002  3182 003 131	350 20 DUT350/330 350GSDC HHIS-3	Chass. 186922-> Sonderausführung / Special design				(56)

		CODE					
--	--	------	--	--	---	---	---



























MERCEDES-BENZ

Unimog 1400-1750							
U 1650,U 1650L 427.116 427.115	01.88-	OM356.956, OM366.948, OM366.949		3482 002 234	350 GMF350X	->Chass. 173809	
				3482 106 133	350 GMF350X	Chass. 173810->	
				1861 956 133	350 20 350GTD		
				1861 713 133 ●#	350 20 350GSZ		
				3151 051 031	KZI-4	->Chass. 173809	
				3182 002 131	HHIS-3	Chass. 173810-> Immer erneuern / Renew everytime	(28)
				3482 012 237	330 GMF330	Sonderausführung / Special design	(56)
				1861 667 034	330 20 330GSB	Sonderausführung / Special design	(56)
				3182 002 131	HHIS-3	Sonderausführung / Special design Immer erneuern / Renew everytime	(56) (28)
				3800 710 002 #  1888 067 031  1861 741 042  3182 003 131	330 20 DUT330 327GSDC HHIS-3	Sonderausführung / Special design	(56)
				1888 998 201 #	330 24 DUT330	für Fahrzeuge mit Niederdruck-Bremsanlage / for vehicles with low-pressure brakesystem enthält eine Kupplungsscheibe / This part number includes one clutch disc Sonderausführung / Special design	(74) (66) (56)
				1861 741 042 ▽#	327 20 327GSDC	Anzahl der Beläge / Number of pads: 8 Lose Kupplungsscheibe / Loose clutch disc Sonderausführung / Special design	(8) (39) (56)
				3182 003 131	HHIS-3	Sonderausführung / Special design Immer erneuern / Renew everytime	(56) (28)
				3800 710 003 ●#  1888 998 902  1862 962 002  3182 003 131	350 20 DUT350/330 350GSDC HHIS-3	Sonderausführung / Special design	(56)
			U 1650,U 1650L 427.117/118 U 1650,U 1650L 427.117/118 U 1700T 437.000 U 1750,U 1750L 437.113 437.112 U 1750,U 1750L 437.131 437.130	09.89-	OM356.980, OM357.924, OM366.984, OM356.957, OM366.963, OM357.945, OM356.997, OM356.981		3482 002 234
05.91-		3482 106 133		350 GMF350X		Chass. 173810->	
09.88-		1861 956 133		350 20 350GTD			
09.88-		1861 713 133 ●#		350 20 350GSZ			
09.88-		3151 051 031		KZI-4		->Chass. 173809	
		3182 002 131		HHIS-3		Chass. 173810-> Immer erneuern / Renew everytime	(28)
		1888 998 902 #		350 24 DUT350/ 330		enthält eine Kupplungsscheibe / This part number includes one clutch disc	(66)
		1862 962 002 ▽#		350 20 350GSDC		Lose Kupplungsscheibe / Loose clutch disc	(39)
		1888 998 902 #		350 24 DUT350/ 330		enthält eine Kupplungsscheibe / This part number includes one clutch disc Sonderausführung / Special design	(66) (56)
		1862 962 002 ▽#		350 20 350GSDC		Lose Kupplungsscheibe / Loose clutch disc Sonderausführung / Special design	(39) (56)
		1863 837 002		GR-4		->Chass. 186921 Sonderausführung / Special design mit Anlauftring / with thrust ring	(56) (88)
		1863 855 000		GR-8		->Chass. 186921 Sonderausführung / Special design mit Anlauftring / with thrust ring	(56) (88)
		3800 710 003 #  1888 998 902  1862 962 002  3182 003 131		350 20 DUT350/330 350GSDC HHIS-3		Chass. 186922-> Sonderausführung / Special design	(56)

		CODE				
--	--	------	--	---	---	---

MERCEDES-BENZ



















Unimog 1400-1750

U 1700, U 1700 L 436.342/343 436.340 437.100 436.341	09.88-	OM382.950, OM356.957, OM366.963	 3482 002 234	350 GMF350X	436.340-341-342-343	
			 1861 956 133	350 20 350GTD	436.340-341-342-343	
			 1861 713 133 ●#	350 20 350GSZ	436.340-341-342-343	
			 3151 051 031	KZI-4	436.340-341-342-343	
			 3482 002 234	350 GMF350X	->Chass. 173809 437.100	
			 3482 106 133	350 GMF350X	Chass. 173810-> 437.100	
			 1861 956 133	350 20 350GTD	437.100	
			 1861 713 133 ●#	350 20 350GSZ	437.100	
			 3151 051 031	KZI-4	->Chass. 173809 437.100	
			 3182 002 131	HHIS-3	Chass. 173810-> 437.100 Immer erneuern / Renew everytime	(28)
			 1888 998 902 #	350 24 DUT350/ 330	437.100/110 enthält eine Kupplungsscheibe / This part number includes one clutch disc	(66)
			 1862 962 002 ▽#	350 20 350GSDC	437.100/110 Lose Kupplungsscheibe / Loose clutch disc	(39)
			 1888 998 902 #	350 24 DUT350/ 330	437.100 enthält eine Kupplungsscheibe / This part number includes one clutch disc Sonderausführung / Special design	(66) (56)
			 1862 962 002 ▽#	350 20 350GSDC	437.100 Lose Kupplungsscheibe / Loose clutch disc Sonderausführung / Special design	(39) (56)
			 1863 837 002	GR-4	->Chass. 186921 437.100 Sonderausführung / Special design mit Anlauftring / with thrust ring	(56) (88)
			 1863 855 000	GR-8	->Chass. 186921 437.100 Sonderausführung / Special design mit Anlauftring / with thrust ring	(56) (88)
			 3800 710 003 #  1888 998 902  1862 962 002  3182 003 131	350 20 DUT350/330 350GSDC HHIS-3	Chass. 186922-> 437.100 Sonderausführung / Special design	(56)
			U 1700,U 1700L 435.111 435.131 435.121 435.141 435.115 435.110 435.120 435.117 435.113			 3482 012 237
 1861 667 034	330 20 330GSB	435.110/113/117/120-121/131/141				
 3151 051 031	KZI-4	435.110/113/117/120-121/131/141				
 1888 067 042 #	330 22 DUT330/ 310	435.110-111/113/115 enthält eine Kupplungsscheibe / This part number includes one clutch disc enthält Druckplattenbefestigungsschrauben / includes bolt for pressure plate mounting				(66) (64)
 1861 741 042 #	327 20 327GSDC	435.110-111/113/115 Anzahl der Beläge / Number of pads: 8 Lose Kupplungsscheibe / Loose clutch disc				(8) (39)
 1863 837 002	GR-4	435.110-111/113/115 mit Anlauftring / with thrust ring				(88)
 1863 855 000	GR-8	435.110-111/113/115 mit Anlauftring / with thrust ring	(88)			









		CODE				
--	--	------	--	---	---	---

MERCEDES-BENZ





















Unimog 1400-1750

U 1700,U 1700L 435.111 435.110	05.78 - 09.88	OM353.959	 3482 012 211	330 GMF330	->Chass. 002154 435.111	
			 3482 012 237	330 GMF330	Chass. 002155-> 435.111	
			 1861 594 034 #	330 20 330GSZ	->Chass. 002154 435.111	
			 1861 667 034	330 20 330GSB	Chass. 002155-> 435.111	
			 3151 051 031	KZI-4	435.111	
			 3482 012 237	330 GMF330	435.110	
			 1861 667 034	330 20 330GSB	435.110	
			 3151 051 031	KZI-4	435.110	
			 1888 067 042 #	330 22 DUT330/ 310	enthält eine Kupplungsscheibe / This part number includes one clutch disc enthält Druckplattenbefestigungsschrauben / includes bolt for pressure plate mounting	(66) (64)
			 1861 741 042 #	327 20 327GSDC	Anzahl der Beläge / Number of pads: 8 Lose Kupplungsscheibe / Loose clutch disc	(8) (39)
			 1863 837 002	GR-4	mit Anlauftring / with thrust ring	(88)
 1863 855 000	GR-8	mit Anlauftring / with thrust ring	(88)			
U 1700L 435.113	05.78 - 09.88	OM353.959	 3482 012 237	330 GMF330		
			 1861 667 034	330 20 330GSB		
			 3151 051 031	KZI-4		
			 1888 067 042 #	330 22 DUT330/ 310	enthält eine Kupplungsscheibe / This part number includes one clutch disc enthält Druckplattenbefestigungsschrauben / includes bolt for pressure plate mounting	(66) (64)
			 1861 741 042 #	327 20 327GSDC	Anzahl der Beläge / Number of pads: 8 Lose Kupplungsscheibe / Loose clutch disc	(8) (39)
			 1863 837 002	GR-4	mit Anlauftring / with thrust ring	(88)
 1863 855 000	GR-8	mit Anlauftring / with thrust ring	(88)			

Unimog 1800-2050

























U 1800,T 437.000-160			 1888 998 902 #	350 24 DUT350/ 330	enthält eine Kupplungsscheibe / This part number includes one clutch disc	(66)
			 1862 962 002 ▽#	350 20 350GSDC	Lose Kupplungsscheibe / Loose clutch disc	(39)
U 1800,T 437.002			 3482 002 234	350 GMF350X	->Chass. 173809	
			 3482 106 133	350 GMF350X	Chass. 173810->	
			 1861 956 133	350 20 350GTD		
			 1861 713 133 ●#	350 20 350GSZ		
			 3151 051 031	KZI-4	->Chass. 173809	
			 3182 002 131	HHIS-3	Chass. 173810-> Immer erneuern / Renew everytime	(28)

MERCEDES-BENZ

Unimog 1800-2050						
U 1800,T 437.102		3482 106 031	360 GMF350X			
		1862 286 031 #	360 20 360GSDC			
		3151 051 031	KZI-4		->Chass. 173809	
		3182 002 131	HHIS-3		Chass. 173810-> Immer erneuern / Renew everytime	(28)
		1888 998 901 ▲#	350 24 DUT350/ 330		enthält eine Kupplungsscheibe / This part number includes one clutch disc Sonderausführung / Special design	(66) (56)
		1878 992 401 ▽#	350 20 350GSDC		Anzahl der Beläge / Number of pads: 8 Lose Kupplungsscheibe / Loose clutch disc Sonderausführung / Special design	(8) (39) (56)
		3182 003 131	HHIS-3		Sonderausführung / Special design Immer erneuern / Renew everytime	(56) (28)
		3800 710 003 # ● 1888 998 902 ● 1862 962 002 🔧 3182 003 131	350 20 DUT350/330 350GSDC HHIS-3		Je nach Kundenwunsch mit unterschiedlicher Kupplung / Equipped with different clutch according to customer requirement Sonderausführung / Special design	(33) (56)
U 1850 L/38 437.133		3482 106 031	360 GMF350X			
		1862 286 031 #	360 20 360GSDC			
		3151 051 031	KZI-4		->Chass. 173809	
		3182 002 131	HHIS-3		Chass. 173810-> Immer erneuern / Renew everytime	(28)
		3800 710 003 # ● 1888 998 902 ● 1862 962 002 🔧 3182 003 131	350 20 DUT350/330 350GSDC HHIS-3		Je nach Kundenwunsch mit unterschiedlicher Kupplung / Equipped with different clutch according to customer requirement Sonderausführung / Special design	(33) (56)
		3482 106 031	360 GMF350X			
U 1850,L 437.115 437.114		1862 286 031 #	360 20 360GSDC			
		3151 051 031	KZI-4		->Chass. 173809	
		3182 002 131	HHIS-3		Chass. 173810-> Immer erneuern / Renew everytime	(28)
		1888 998 902 #	350 24 DUT350/ 330		enthält eine Kupplungsscheibe / This part number includes one clutch disc	(66)
		1862 962 002 ▽#	350 20 350GSDC		Lose Kupplungsscheibe / Loose clutch disc	(39)
		3800 710 003 # ● 1888 998 902 ● 1862 962 002 🔧 3182 003 131	350 20 DUT350/330 350GSDC HHIS-3		Je nach Kundenwunsch mit unterschiedlicher Kupplung / Equipped with different clutch according to customer requirement Sonderausführung / Special design	(33) (56)
		3482 106 031	360 GMF350X			

		CODE				
--	--	------	--	---	---	---































MERCEDES-BENZ

Unimog 2100-2450							
U 2100 437.105 U 2100T 437.002 U 2150,U 2150L 437.118 437.117 437.136 U 2400 437.105 U 2450,U 2450L 437.136 437.117/118	09.89 -	OM356.980, OM366.984, OM357.945, OM356.997		3482 002 239 #	360 GMF350X	->Chass. 173809	
	09.89 -			3482 106 031	360 GMF350X	Chass. 173810->	
	09.89 -			1862 286 031 #	360 20 360GSDC		
	05.91 -			3151 051 031	KZI-4	->Chass. 173809	
	05.91 -			3182 002 131	HHIS-3	Chass. 173810-> Immer erneuern / Renew everytime	(28)
				1888 998 902 #	350 24 DUT350/ 330	enthält eine Kupplungsscheibe / This part number includes one clutch disc	(66)
				1862 962 002 ▽#	350 20 350GSDC	Lose Kupplungsscheibe / Loose clutch disc	(39)
				1888 998 901 ▲#	350 24 DUT350/ 330	enthält eine Kupplungsscheibe / This part number includes one clutch disc Sonderausführung / Special design	(66) (56)
				1878 992 401 ▽#	350 20 350GSDC	Anzahl der Beläge / Number of pads: 8 Lose Kupplungsscheibe / Loose clutch disc Sonderausführung / Special design	(8) (39) (56)
				1888 998 902 #	350 24 DUT350/ 330	enthält eine Kupplungsscheibe / This part number includes one clutch disc Sonderausführung / Special design	(66) (56)
				1862 962 002 ▽#	350 20 350GSDC	Lose Kupplungsscheibe / Loose clutch disc Sonderausführung / Special design	(39) (56)
				1863 837 002	GR-4	->Chass. 186921 Sonderausführung / Special design mit Anlauftring / with thrust ring	(56) (88)
				1863 855 000	GR-8	->Chass. 186921 Sonderausführung / Special design mit Anlauftring / with thrust ring	(56) (88)
				3800 710 003 #  1888 998 902  1862 962 002  3182 003 131	350 20 DUT350/330 350GSDC HHIS-3	Chass. 186922-> Sonderausführung / Special design	(56)
	U 2150 437.135		09.89 -	OM366.984, OM356.997		3482 002 239 #	360 GMF350X
			3482 106 031		360 GMF350X	Chass. 173810->	
			1862 286 031 #		360 20 360GSDC		
			3151 051 031		KZI-4	->Chass. 173809	
			3182 002 131		HHIS-3	Chass. 173810-> Immer erneuern / Renew everytime	(28)
			1888 998 902 #		350 24 DUT350/ 330	enthält eine Kupplungsscheibe / This part number includes one clutch disc Sonderausführung / Special design	(66) (56)
			1862 962 002 ▽#		350 20 350GSDC	Lose Kupplungsscheibe / Loose clutch disc Sonderausführung / Special design	(39) (56)

		CODE				
--	--	------	--	---	---	---



























MERCEDES-BENZ

Unimog 2100-2450

U 2150,U 2150L 437.136 437.118 437.171 437.117 437.170	09.89-	OM357.924, OM366.984, OM356.997	 3482 002 239 #	360 GMF350X	->Chass. 173809 437.117-118/136	
			 3482 106 031	360 GMF350X	Chass. 173810-> 437.117-118/136	
			 1862 286 031 #	360 20 360GSDC	437.117-118/136	
			 3151 051 031	KZI-4	->Chass. 173809 437.117-118/136	
			 3182 002 131	HHIS-3	Chass. 173810-> 437.117-118/136 Immer erneuern / Renew everytime	(28)
			 1888 998 902 #	350 24 DUT350/ 330	437.117-118/136 enthält eine Kupplungsscheibe / This part number includes one clutch disc	(66)
			 1862 962 002 ▽#	350 20 350GSDC	437.117-118/136 Lose Kupplungsscheibe / Loose clutch disc	(39)
			 1888 998 901 ▲#	350 24 DUT350/ 330	437.117-118/136 enthält eine Kupplungsscheibe / This part number includes one clutch disc Sonderausführung / Special design	(66) (56)
			 1878 992 401 ▽#	350 20 350GSDC	437.117-118/136 Anzahl der Beläge / Number of pads: 8 Lose Kupplungsscheibe / Loose clutch disc Sonderausführung / Special design	(8) (39) (56)
			 1888 998 902 #	350 24 DUT350/ 330	437.117-118/136 enthält eine Kupplungsscheibe / This part number includes one clutch disc Sonderausführung / Special design	(66) (56)
			 1862 962 002 ▽#	350 20 350GSDC	437.117-118/136 Lose Kupplungsscheibe / Loose clutch disc Sonderausführung / Special design	(39) (56)
			 1863 837 002	GR-4	->Chass. 186921 437.117-118/136 Sonderausführung / Special design mit Anlauffring / with thrust ring	(56) (88)
			 1863 855 000	GR-8	->Chass. 186921 437.117-118/136 Sonderausführung / Special design mit Anlauffring / with thrust ring	(56) (88)
			 3800 710 003 #  1888 998 902  1862 962 002  3182 003 131	350 20 DUT350/330 350GSDC HHIS-3	Chass. 186922-> 437.117-118/136 Sonderausführung / Special design	(56)
			 3482 106 031	360 GMF350X	437.170-171	
			 1862 286 031 #	360 20 360GSDC	437.170-171	
 3182 002 131	HHIS-3	437.170-171 Immer erneuern / Renew everytime	(28)			
U 2400TG 437.182	07.93-	OM356.980, OM357.945	 3482 106 031	360 GMF350X		
			 1862 286 031 #	360 20 360GSDC		
			 3182 002 131	HHIS-3	Immer erneuern / Renew everytime	(28)
			 1888 998 902 #	350 24 DUT350/ 330	enthält eine Kupplungsscheibe / This part number includes one clutch disc	(66)
			 1862 962 002 #	350 20 350GSDC		
			 1863 837 002	GR-4	->Chass. 186921 mit Anlauffring / with thrust ring	(88)
			 1863 855 000	GR-8	->Chass. 186921 mit Anlauffring / with thrust ring	(88)
 3800 710 003 #  1888 998 902  1862 962 002  3182 003 131	350 20 DUT350/330 350GSDC HHIS-3	Chass. 186922->				

		CODE				
--	--	------	--	---	---	---



MERCEDES-BENZ

Unimog 2100-2450						
U 2450L 437.156	07.93-	OM356.980, OM357.945	 3482 106 031	360 GMF350X		
			 1862 286 031 #	360 20 360GSDC		
			 3182 002 131	HHIS-3	Immer erneuern / Renew everytime	(28)
			 3800 710 003 #  1888 998 902  1862 962 002  3182 003 131	350 20 DUT350/330 350GSDC HHIS-3	Sonderausführung / Special design	(56)
Unimog 2500-5000						
U 3000 437.420 437.426 437.425 437.421 U 3000 437.420 437.425 U 4000 436.330 U 4000 437.425/426 437.420/421 U 4000 437.420/421 437.425 436.330 437.426	09.02-	OM900.920, OM904LA, OM904.953, OM904.952	 3482 000 462	362 MF362		
	09.02-		 1878 600 560	360 18 360CBC	Anzahl der Beläge / Number of pads: 9 Je nach Kundenwunsch mit unterschiedlicher Kupplung / Equipped with different clutch according to customer requirement	(8) (33)
	01.02-		 1878 052 842	362 18 362WGTB	Je nach Kundenwunsch mit unterschiedlicher Kupplung / Equipped with different clutch according to customer requirement	(33)
	09.02-		 1878 001 939 HD●	362 18 362WGTB	Je nach Kundenwunsch mit unterschiedlicher Kupplung / Equipped with different clutch according to customer requirement	(33)
	09.02-		 3182 600 101	HHIS-3	mit Sensor / with sensor Füllmedium: Bremsflüssigkeit / Fill Medium: Brake Fluid Immer erneuern / Renew everytime	(92) (23) (28)
U 4000 437.426 437.421 437.420 437.425	09.02-	OM904LA	 3482 000 462	362 MF362	437.421/426	
			 1878 600 560	360 18 360CBC	437.421/426 Anzahl der Beläge / Number of pads: 9	(8)
			 3182 600 101	HHIS-3	437.421/426 mit Sensor / with sensor Füllmedium: Bremsflüssigkeit / Fill Medium: Brake Fluid Immer erneuern / Renew everytime	(92) (23) (28)
U 5000 437.430/431 437.435/436 437.465 437.460	09.02-	OM924.916	 3482 000 462	362 MF362	437.430/435	
			 1878 600 560	360 18 360CBC	437.430/435 Anzahl der Beläge / Number of pads: 9 Je nach Kundenwunsch mit unterschiedlicher Kupplung / Equipped with different clutch according to customer requirement	(8) (33)
			 1878 052 842	362 18 362WGTB	437.430/435 Je nach Kundenwunsch mit unterschiedlicher Kupplung / Equipped with different clutch according to customer requirement	(33)
			 1878 001 939 HD●	362 18 362WGTB	437.430/435 Je nach Kundenwunsch mit unterschiedlicher Kupplung / Equipped with different clutch according to customer requirement	(33)
			 3182 600 101	HHIS-3	437.430/435 mit Sensor / with sensor Füllmedium: Bremsflüssigkeit / Fill Medium: Brake Fluid Immer erneuern / Renew everytime	(92) (23) (28)
		OM924.923	 3482 000 462	362 MF362	437.460/465	
			 1878 600 560	360 18 360CBC	437.460/465 Anzahl der Beläge / Number of pads: 9	(8)
			 3182 600 101	HHIS-3	437.460/465 mit Sensor / with sensor Füllmedium: Bremsflüssigkeit / Fill Medium: Brake Fluid Immer erneuern / Renew everytime	(92) (23) (28)
		OM924LA	 3482 000 462	362 MF362	437.431/436	
			 1878 600 560	360 18 360CBC	437.431/436 Anzahl der Beläge / Number of pads: 9	(8)
			 3182 600 101	HHIS-3	437.431/436 mit Sensor / with sensor Füllmedium: Bremsflüssigkeit / Fill Medium: Brake Fluid Immer erneuern / Renew everytime	(92) (23) (28)







		CODE				
--	--	------	--	---	---	---

MERCEDES-BENZ













































Unimog 2500-5000

U 5000 437.470	11.02-	OM906.935		3482 000 463	395 MF395		
				3182 600 101	HHIS-3	mit Sensor / with sensor Füllmedium: Bremsflüssigkeit / Fill Medium: Brake Fluid Immer erneuern / Renew everytime	(92) (23) (28)

VARIO 09.96 -

812 DA 670.422 670.421	01.96-	OM904LA		3400 127 701 	362 18 MF362 362WGTB	670.421-422	
				3400 700 484 HD 	362 10 MF362 362WGTB	670.421-422	
				3482 000 462 1878 001 939			
				3151 000 396	KZIS-4	670.421-422	





VARIO Kasten / Box 09.96 -

512 D (667.351, 667.352, 667.353)	09.96-	OM602DELA		3000 725 001  3082 269 031  1864 504 031  3151 248 031	250 26 M250 250B KZIS-0	667.321-323/351-353	
				3000 951 785 ●  3082 269 031  1878 600 501  3151 248 031	250 26 M250 250CD KZIS-0	667.321-323/351-353	
		OM602.984		2294 000 525	250 250		
612 D (668.351, 668.352, 668.353)	09.96-	OM602DELA		3000 725 001  3082 269 031  1864 504 031  3151 248 031	250 26 M250 250B KZIS-0	668.321-323/331-332/351-353	
				3000 951 785 ●  3082 269 031  1878 600 501  3151 248 031	250 26 M250 250CD KZIS-0	668.321-323/331-332/351-353	
		OM602.985, OM602.984		2294 000 525	250 250		
613 D, 614 D (668.351, 668.352, 668.353), 95 kW	09.96-	OM904LA		3400 127 701 	362 18 MF362 362WGTB	668.321-323/331-332/351-353	
				3482 000 462 1878 052 842			
	09.96-			3400 700 484 HD 	362 10 MF362 362WGTB	668.321-323/331-332/351-353	
	09.98-			3482 000 462 1878 001 939			
615 D, 616 D (668.351, 668.352, 668.353), 100 kW	09.96-			3151 000 396	KZIS-4	668.321-323/331-332/351-353	
615 D, 616 D (668.351, 668.352, 668.353), 112 kW	09.98-						
615 D, 616 D (668.351, 668.352, 668.353), 115 kW	09.98-						
812 D (670.351, 670.352, 670.353)	09.96-	OM602LADE		3000 725 001  3082 269 031  1864 504 031  3151 248 031	250 26 M250 250B KZIS-0		
				3000 951 785 ●  3082 269 031  1878 600 501  3151 248 031	250 26 M250 250CD KZIS-0		
	09.96-			2294 000 525	250 250		
	09.96-						
813 D, 814 D (670.351, 670.352, 670.353), 95 kW	09.96-	OM904LA		3400 127 701 	362 18 MF362 362WGTB		
				3482 000 462 1878 052 842			
	09.96-			3400 700 484 HD 	362 10 MF362 362WGTB		
	09.96-			3482 000 462 1878 001 939			
813 D, 814 D (670.351, 670.352, 670.353), 100 kW	09.96-						
815 D, 816 D (670.351, 670.352, 670.353), 112 kW	09.96-						
815 D, 816 D (670.351, 670.352, 670.353), 115 kW	09.96-						



















		CODE				
--	--	------	--	---	---	---

MERCEDES-BENZ

VARIO Kasten / Box 09.96 -

813 DA, 814 DA 4x4 (669.599, 670.451, 670.452, 670.453), 95 kW	09.96-	OM602LADE		3000 951 785 ⊗ 3082 269 031 ⊗ 1878 600 501 ⊙ 3151 248 031	250 26 M250 250CD KZIS-0	
813 DA, 814 DA 4x4 (669.599, 670.451, 670.452, 670.453), 100 kW	09.96-			2294 000 525	250 250	
815 DA, 816 DA 4x4 (669.599, 670.451, 670.452, 670.453), 112 kW	09.96-	OM904LA		3400 127 701 ☉ ⊗ 3482 000 462 ⊗ 1878 052 842	362 18 MF362 362WG TB	
815 DA, 816 DA 4x4 (669.599, 670.451, 670.452, 670.453), 115 kW	09.96-			3400 700 484 HD ● ⊗ 3482 000 462 ⊗ 1878 001 939	362 10 MF362 362WG TB	
				3151 000 396	KZIS-4	



















VARIO Pritsche / Flatbed 09.96 -

512 D (667.321, 667.322, 667.323)	09.96-	OM602DELA		3000 725 001 ⊗ 3082 269 031 ⊗ 1864 504 031 ⊙ 3151 248 031	250 26 M250 250B KZIS-0	667.321-323/351-353
				3000 951 785 ● ⊗ 3082 269 031 ⊗ 1878 600 501 ⊙ 3151 248 031	250 26 M250 250CD KZIS-0	667.321-323/351-353
		OM602.984		2294 000 525	250 250	
612 D (668.321, 668.322, 668.323)	09.96-	OM602DELA		3000 725 001 ⊗ 3082 269 031 ⊗ 1864 504 031 ⊙ 3151 248 031	250 26 M250 250B KZIS-0	668.321-323/331-332/351-353
				3000 951 785 ● ⊗ 3082 269 031 ⊗ 1878 600 501 ⊙ 3151 248 031	250 26 M250 250CD KZIS-0	668.321-323/331-332/351-353
		OM602.985, OM602.984		2294 000 525	250 250	
613 D, 614 D (668.321, 668.322, 668.323), 95 kW	09.96-	OM904LA		3400 127 701 ☉ ⊗ 3482 000 462 ⊗ 1878 052 842	362 18 MF362 362WG TB	668.321-323/331-332/351-353
				3400 700 484 HD ● ⊗ 3482 000 462 ⊗ 1878 001 939	362 10 MF362 362WG TB	668.321-323/331-332/351-353
613 D, 614 D (668.321, 668.322, 668.323), 100 kW	09.96-					
615 D, 616 D (668.321, 668.322, 668.323), 112 kW	09.98-					
615 D, 616 D (668.321, 668.322, 668.323), 115 kW	09.98-			3151 000 396	KZIS-4	668.321-323/331-332/351-353
812 D (670.321, 670.322, 670.323, 670.324)	09.96-	OM602LADE		3000 725 001 ⊗ 3082 269 031 ⊗ 1864 504 031 ⊙ 3151 248 031	250 26 M250 250B KZIS-0	
				3000 951 785 ● ⊗ 3082 269 031 ⊗ 1878 600 501 ⊙ 3151 248 031	250 26 M250 250CD KZIS-0	
813 D, 814 D (670.321, 670.322, 670.323, 670.324), 95 kW	09.96-					
813 D, 814 D (670.321, 670.322, 670.323, 670.324), 100 kW	09.96-			2294 000 525	250 250	
815 D, 816 D (670.321, 670.322, 670.323, 670.324), 112 kW	09.96-	OM904LA		3400 127 701 ☉ ⊗ 3482 000 462 ⊗ 1878 052 842	362 18 MF362 362WG TB	
815 D, 816 D (670.321, 670.322, 670.323, 670.324), 115 kW	09.96-			3400 700 484 HD ● ⊗ 3482 000 462 ⊗ 1878 001 939	362 10 MF362 362WG TB	
				3151 000 396	KZIS-4	
813 DA, 814 DA 4x4 (670.421, 670.422, 670.423), 95 kW	09.96-	OM904LA		3400 127 701 ☉ ⊗ 3482 000 462 ⊗ 1878 052 842	362 18 MF362 362WG TB	
				3400 700 484 HD ● ⊗ 3482 000 462 ⊗ 1878 001 939	362 10 MF362 362WG TB	
813 DA, 814 DA 4x4 (670.421, 670.422, 670.423), 100 kW	09.96-					
815 DA, 816 DA 4x4 (670.421, 670.422, 670.423), 112 kW	09.96-					
815 DA, 816 DA 4x4 (670.421, 670.422, 670.423), 115 kW	09.96-			3151 000 396	KZIS-4	







		CODE				
--	--	------	--	---	---	---

MERCEDES-BENZ

VARIO Kipper / Dumptruck 09.96 -

612 D (668.331, 668.332)	09.96 -	OM602DELA	 3000 725 001 ⊗ 3082 269 031 ⊗ 1864 504 031 ⊙ 3151 248 031	250 26 M250 250B KZIS-0	668.321-323/331-332/351-353
			 3000 951 785 ● ⊗ 3082 269 031 ⊗ 1878 600 501 ⊙ 3151 248 031	250 26 M250 250CD KZIS-0	668.321-323/331-332/351-353
		OM602.985, OM602.984	 2294 000 525	250 250	
613 D, 614 D (668.331, 668.332), 95 kW	09.96 -	OM904LA	 3400 127 701 ☾ ⊗ 3482 000 462 ⊗ 1878 052 842	362 18 MF362 362WG TB	668.321-323/331-332/351-353
613 D, 614 D (668.331, 668.332), 100 kW	09.96 -		 3400 700 484 HD ●	362 10	668.321-323/331-332/351-353
615 D, 616 D (668.331, 668.332), 112 kW	09.98 -		 3482 000 462 ⊗ 1878 001 939	MF362 362WG TB	
615 D, 616 D (668.331, 668.332), 115 kW	09.98 -		 3151 000 396	KZIS-4	668.321-323/331-332/351-353
812 D (670.331, 670.332)	09.96 -	OM602LADE	 3000 725 001 ⊗ 3082 269 031 ⊗ 1864 504 031 ⊙ 3151 248 031	250 26 M250 250B KZIS-0	
813 D, 814 D (670.331, 670.332), 95 kW	09.96 -		 3000 951 785 ● ⊗ 3082 269 031 ⊗ 1878 600 501 ⊙ 3151 248 031	250 26 M250 250CD KZIS-0	
813 D, 814 D (670.331, 670.332), 100 kW	09.96 -		 2294 000 525	250 250	
815 D, 816 D (670.331, 670.332), 112 kW	09.96 -		OM904LA	 3400 127 701 ☾ ⊗ 3482 000 462 ⊗ 1878 052 842	362 18 MF362 362WG TB
815 D, 816 D (670.331, 670.332), 115 kW	09.96 -	 3400 700 484 HD ●		362 10	
		 3482 000 462 ⊗ 1878 001 939		MF362 362WG TB	
			 3151 000 396	KZIS-4	
813 DA, 814 DA 4x4 (670.431, 670.432), 95 kW	09.96 -	OM904LA	 3400 127 701 ☾ ⊗ 3482 000 462 ⊗ 1878 052 842	362 18 MF362 362WG TB	
813 DA, 814 DA 4x4 (670.431, 670.432), 100 kW	09.96 -		 3400 700 484 HD ●	362 10	
815 DA, 816 DA 4x4 (670.431, 670.432), 112 kW	09.96 -		 3482 000 462 ⊗ 1878 001 939	MF362 362WG TB	
815 DA, 816 DA 4x4 (670.431, 670.432), 115 kW	09.96 -		 3151 000 396	KZIS-4	







VARIO Triebkopf 09.96 -

810 DT (670.398)	09.96 -	OM602LADE	 3000 725 001 ⊗ 3082 269 031 ⊗ 1864 504 031 ⊙ 3151 248 031	250 26 M250 250B KZIS-0	
			 3000 951 785 ● ⊗ 3082 269 031 ⊗ 1878 600 501 ⊙ 3151 248 031	250 26 M250 250CD KZIS-0	
812 DT (670.398), 100 kW	09.96 -		 2294 000 525	250 250	
812 DT (670.398), 112 kW	09.96 -	OM904LA	 3400 127 701 ☾ ⊗ 3482 000 462 ⊗ 1878 052 842	362 18 MF362 362WG TB	
			 3400 700 484 HD ●	362 10	
			 3482 000 462 ⊗ 1878 001 939	MF362 362WG TB	
			 3151 000 396	KZIS-4	











		CODE				
--	--	------	--	---	---	---

MERCEDES-BENZ







ZETROS 09.08 -

1833 A 949.016 2733 A 949.066	09.08 -	OM926.935, OM926.947, OM926.936		3400 700 477   3482 000 679  1878 006 637	395 18 MF395 395WGTZC		
	09.08 -			3421 601 049	395	für / for: SA 505009-17/47/57 926.935 mit Zahnkranz / with ring gear ohne Anlaufing / without thrust ring	(68) (93) (102)
			3421 601 049	395	für / for: SA 505009-57 926.947 mit Zahnkranz / with ring gear ohne Anlaufing / without thrust ring	(68) (93) (102)	
			3421 601 069		für / for: SA 505009-28 926.935	(68)	
			3421 601 069		für / for: SA 505009-28 926.947	(68)	
				3182 998 501	HHIS-3	für / for: SA 504673-10/22 Getr. / GBox: G131-9 ohne Sensor / without sensor Füllmedium: Bremsflüssigkeit / Fill Medium: Brake Fluid Immer erneuern / Renew everytime	(68) (104) (23) (28)
	3182 600 141			für / for: SA 504673-16 Getr. / GBox: G131-9 ohne Sensor / without sensor Füllmedium: Mineralöl / Fill Medium: Mineral Oil Immer erneuern / Renew everytime	(68) (104) (24) (28)		
	3182 600 166			für / for: SA 504673-17/27/35 Getr. / GBox: G131-9 mit Sensor / with sensor Füllmedium: Mineralöl / Fill Medium: Mineral Oil Immer erneuern / Renew everytime	(68) (92) (24) (28)		

206





















L 206		A60		3082 121 031	228 M228		
				1861 557 236 #	228 10 228GSB		
				1878 634 052	228 10 228GSB		
				3151 034 031 ▲	KZI-1		
L 206 D	-05.72	OM615		1861 421 032 #	228 24 228CB		
				3151 270 602	KT-0		
				1805 041 200			
L 206 DG (2,4/2,5 to)		OM615		1861 421 032 #	228 24 228CB	->Chass. 108506	
				3082 121 031	228 M228	->Chass. 108506 Nur verbauen, wenn Fahrzeug mit M-Kupplung ausgerüstet ist / Only install if the vehicle is equipped with an M-type clutch	(50)
				3082 078 032	215 M215	Chass. 108507->	
L 206 DG (2,8 to)		OM615		1861 421 032 #	228 24 228CB		
				3082 121 031	228 M228	Nur verbauen, wenn Fahrzeug mit M-Kupplung ausgerüstet ist / Only install if the vehicle is equipped with an M-type clutch	(50)

306

L 306		A60		3082 121 031	228 M228		
				1861 557 236 #	228 10 228GSB		
				1878 634 052	228 10 228GSB		
				3151 034 031 ▲	KZI-1		
L 306 D	-05.72	OM615		1861 421 032 #	228 24 228CB		
				3151 270 602	KT-0		
				1805 041 200			





		CODE				
--	--	------	--	---	---	---







MERCEDES-BENZ

306							
L 306 D	06.72-	OM615		1861 421 032 #	228 24 228CB		
				3082 121 031	228 M228	Nur verbauen, wenn Fahrzeug mit M-Kupplung ausgerüstet ist / Only install if the vehicle is equipped with an M-type clutch	(50)
				3151 034 031 ▲	KZI-1	Nur verbauen, wenn Fahrzeug mit M-Kupplung ausgerüstet ist / Only install if the vehicle is equipped with an M-type clutch	(50)
L 306 D		OM615		3082 121 031	228 M228		
				3151 034 031 ▲	KZI-1		
L 306 DG (3,1/3,5 to)		OM615		1861 421 032 #	228 24 228CB		
				3082 121 031	228 M228	Nur verbauen, wenn Fahrzeug mit M-Kupplung ausgerüstet ist / Only install if the vehicle is equipped with an M-type clutch	(50)
L 306 DG (4,1/5,0 to)		A70, OM615		1861 421 032 #	228 24 228CB		
				3082 121 031	228 M228	Nur verbauen, wenn Fahrzeug mit M-Kupplung ausgerüstet ist / Only install if the vehicle is equipped with an M-type clutch	(50)
307							
L 307 606.244 606.044 606.026-028 606.221-224 606.021-024 606.206-208 606.226-228 606.006-045 606.200-204 606.421 606.000-004 606.240/241 606.245 606.040/041		A70		1861 574 132 #	228 24 228CPB	606.026-028/040-041/044-045/000-004/006-008 /021-024/226-228/240-241/244-245/421/200-204 /206-208/221-224	
				3082 121 031	228 M228	606.226-228/240-241/244-245/421/200-204 /206-208/221-224 Nur verbauen, wenn Fahrzeug mit M-Kupplung ausgerüstet ist / Only install if the vehicle is equipped with an M-type clutch	(50)
310							
310 D 690.331 690.330 690.311 690.340/341				1878 000 615	240 26 240VTB	für OE-Nummer / for OE number 690 250 74 03 für / for: Sprinter Argentina nur in Verbindung mit / only in connection with: 3082 307 531	
(83) (68) (101)							
311							
L,LA,LP,LAP,LG 311				1860 062 037 #	280 10 280Z		
312							
L,LA,LP,LAP,LG 312				1860 062 037 #	280 10 280Z		
315							
LP 315				1881 039 532 #	350 G350KR		
				1861 034 147 #	350 10 350		
319							
L 319 B		M121		1881 059 208	200 KS200	->Chass. 004861	
				1861 123 236	200 10 200PE	->Chass. 004861	
				3082 121 031	228 M228	Chass. 004862-> Nur verbauen, wenn Fahrzeug mit M-Kupplung ausgerüstet ist / Only install if the vehicle is equipped with an M-type clutch	(50)
				3151 034 031 ▲	KZI-1	Chass. 004862-> Nur verbauen, wenn Fahrzeug mit M-Kupplung ausgerüstet ist / Only install if the vehicle is equipped with an M-type clutch	(50)

		CODE				
--	--	------	--	---	---	---

MERCEDES-BENZ









319							
L 319 D		OM621, 636		1881 059 208	200 KS200	->Chass. 082858	
				1861 123 236	200 10 200PE	->Chass. 082858	
				3082 121 031	228 M228	Chass. 082859-> Nur verbauen, wenn Fahrzeug mit M-Kupplung ausgerüstet ist / Only install if the vehicle is equipped with an M-type clutch	(50)
				3151 034 031 ▲	KZI-1	Chass. 082859-> Nur verbauen, wenn Fahrzeug mit M-Kupplung ausgerüstet ist / Only install if the vehicle is equipped with an M-type clutch	(50)

322							
L,LA 322 327				1882 230 238	280 HVB280		
				1861 919 134	280 10 280GTZ		
				1861 919 134	280 10 280GTZ		
				3151 095 043	KZI-3		
LAK,LAS,LK,LPS,LS 322 327 LAP 322 LP 322	02.61 - 02.61 -			1882 230 238	280 HVB280		
				1861 919 134	280 10 280GTZ		

323							
LA,LAK 323				1860 062 037 #	280 10 280Z		

325							
L 325				1861 034 147 #	350 10 350		







326							
L,LP 326				1881 041 656 #	380 G380		





329							
L 329				1881 039 532 #	350 G350KR	Chass. 9500075->	
				1861 034 147 #	350 10 350		
LA 329				1882 110 532 #	350 GF350		
				1861 034 147 #	350 10 350		
LA 329				1881 039 532 #	350 G350KR	Chass. 9500092->	
				1861 034 147 #	350 10 350		
LP 329				1881 039 532 #	350 G350KR	Chass. 9500032->	
				1861 034 147 #	350 10 350		

330							
L 330				1881 039 532 #	350 G350KR	Chass. 9500319->	
				1861 034 147 #	350 10 350		



		CODE				
--	--	------	--	---	---	---

MERCEDES-BENZ

331						
L 331				1881 039 532 #	350 G350KR	Chass. 9500062->
				1861 034 147 #	350 10 350	
LA 331				1881 039 532 #	350 G350KR	Chass. 9500009->
				1861 034 147 #	350 10 350	
LP 331				1881 039 532 #	350 G350KR	Chass. 9500129->
				1861 034 147 #	350 10 350	



332						
L 332				1882 110 532 #	350 GF350	
				1881 039 532 #	350 G350KR	Chass. 9500277->
				1861 034 147 #	350 10 350	
LA 332				1881 039 532 #	350 G350KR	Chass. 9500053->
				1861 034 147 #	350 10 350	

333						
LP 333				1881 041 656 #	380 G380	



334						
L,LA 334				1882 166 737	380 GF380	
				1863 010 100	GR-4	mit Anlauftring / with thrust ring
L,LP,LK,LS 334				1881 041 656 #	380 G380	

335						
335				1882 166 737	380 GF380	
				1863 010 100	GR-4	mit Anlauftring / with thrust ring

336						
336				1882 166 737	380 GF380	
				1863 010 100	GR-4	mit Anlauftring / with thrust ring





























337						
337				1882 110 542	350 GF350	
				1878 001 074	350 10 350GTZ	

354						
L,LP 354				1882 110 542	350 GF350	
				1878 001 074	350 10 350GTZ	

406						
L 406 D	01.72-	OM636, OM621		1881 059 208	200 KS200	->Chass. 082858
				1861 123 236	200 10 200PE	->Chass. 082858





































		CODE				
--	--	------	--	---	---	---

MERCEDES-BENZ

406						
L 406 D	-12.80	OM636, OM621		3082 121 031	228 M228	Chass. 082859-> Nur verbauen, wenn Fahrzeug mit M-Kupplung ausgerüstet ist / Only install if the vehicle is equipped with an M-type clutch (50)
				3151 034 031 ▲	KZI-1	Chass. 082859-> Nur verbauen, wenn Fahrzeug mit M-Kupplung ausgerüstet ist / Only install if the vehicle is equipped with an M-type clutch (50)
408						
L 408 D		OM314		1882 205 234	250 HBX250	
				1861 291 136	250 10 250GTZ	
				3151 095 043	KZI-3	
409						
LKO 409 309.030-035		M121		1881 059 208	200 KS200	->Chass. 004861
				1861 123 236	200 10 200PE	->Chass. 004861
		M115, 121		1878 634 052	228 10 228GSB	->Chass. 145736
				1861 557 236 #	228 10 228GSB	->Chass. 145736
		OM115, 121		3082 121 031	228 M228	->Chass. 145736 Nur verbauen, wenn Fahrzeug mit M-Kupplung ausgerüstet ist / Only install if the vehicle is equipped with an M-type clutch (50)
				3082 121 031	228 M228	Chass. 145737->
				1861 557 236 #	228 10 228GSB	Chass. 145737 - Chass. 556499
				1878 634 052	228 10 228GSB	Chass. 145737 - Chass. 556499
				3151 034 031 ▲	KZI-1	Chass. 145737 - Chass. 184086
				3151 000 206	KZIS-1	Chass. 184087 - Chass. 556499
508						
L 508		OM314		1882 205 234	250 HBX250	Chass. 145737 LHD - Mot. 678174 LHD Chass. 148037 RHD - Mot. 678174 RHD
				1861 291 136	250 10 250GTZ	Chass. 145737 LHD - Mot. 678174 LHD Chass. 148037 RHD - Mot. 678174 RHD
				3151 033 031	KZI-3	Chass. 145737 LHD - Mot. 678174 LHD Chass. 148037 RHD - Mot. 678174 RHD
L 508 D LS 508 D		OM314		1882 205 234	250 HBX250	
				1861 291 136	250 10 250GTZ	
				3151 095 043	KZI-3	
L 508 D 667.361		OM601		3082 121 031	228 M228	
				1861 936 142	228 10 228VTB	
				3151 000 206	KZIS-1	
LF 508 D 310.350		OM314		1800 125 201	250 10	Mot. 410748-> 310.350
				1882 205 234	HBX250	
				1861 291 136	250GTZ	
	3151 044 031	KZI-3				
	3151 033 031	KZI-3	->Mot. 410747 310.350			





















		CODE				
--	--	------	--	---	---	---

MERCEDES-BENZ

508						
LK 508 DG 309.445 309.444 309.440-442 LK 508 DG 309.440-445		OM314	 1800 125 201  1882 205 234  1861 291 136  3151 044 031	250 10 HBX250 250GTZ KZI-3	Mot. 678175-> 309.440-445	
			 3151 095 043	KZI-3	->Chass. 145736 LHD ->Chass. 148036 RHD 309.440-445	
			3151 033 031	KZI-3	Chass. 145737 LHD - Mot. 678174 LHD Chass. 148037 RHD - Mot. 678174 RHD 309.440-445	
LP 508 DG 309			 1882 205 234	250 HBX250	309	
			 1861 291 136	250 10 250GTZ	309	
			 3151 033 031	KZI-3	309	
608						
LP 608, LPL 608 314.820 314.056/057 314.060 314.253 314.059 314.051/052 314.055 314.252 314.053 314.058 314.251 LPS 608, LPLS 608 314.263 314.062/063	09.63 - 12.84	OM314	 1800 125 201  1882 205 234  1861 291 136  3151 044 031	250 10 HBX250 250GTZ KZI-3	Mot. 410748-> 314.251-252-253/263/051-060/062-063/072 /085-087	
			 3151 095 043	KZI-3	->Chass. 4282707 314.051-060/062-063/072/085-087	
	09.63 - 12.84		3151 033 031	KZI-3	->Mot. 410747 314.251-252-253/263/051-060/062-063/072 /085-087	
LPK 608 314.072	10.69 - 10.77	OM314	 1800 125 201  1882 205 234  1861 291 136  3151 044 031	250 10 HBX250 250GTZ KZI-3	Mot. 410748-> 314.051-060/062-063/072/085-087	
			 3151 095 043	KZI-3	->Chass. 4282707 314.051-060/062-063/072/085-087	
			3151 033 031	KZI-3	Chass. 4282708 - Mot. 410747 314.051-060/062-063/072/085-087	
LPKF 608 314.083 314.081/082 LPKO 608 314.075 314.077	09.63 - 12.84	OM314.944, OM314.910	 1800 125 201  1882 205 234  1861 291 136  3151 044 031	250 10 HBX250 250GTZ KZI-3	Mot. 410748-> 314.077/081-083	
	02.66 - 07.77		 3151 095 043	KZI-3	->Chass. 4282707 314.077/081-083	
			3151 033 031	KZI-3	Chass. 4282708 - Mot. 410747 314.077/081-083	
LT 608 D 310.100		OM314	 1800 125 201  1882 205 234  1861 291 136  3151 044 031	250 10 HBX250 250GTZ KZI-3	310.100	
709						
709 673.003 673.002 673.001 709 K 673.040	03.84 - 12.98	OM364	 3482 046 031 #	280 MF280		
	03.84 - 10.90		 1861 919 134	280 10 280GTZ		
			 3482 008 038	310 MF310	für / for: SA24481-01 Sonderausführung / Special design	(68) (56)
			 1861 303 248	310 10 310GSB	für / for: SA24481-01 Sonderausführung / Special design	(68) (56)
			 3151 044 031	KZI-3		
LP 709, LPL 709 314.252 314.052 314.251 314.255 314.053 314.253 314.051 314.254 LPK 709 314.072 LPKF 709 314.083 314.081/082 LPS 709, LPLS 709 314.263 314.063	09.63 - 12.84	OM314	 1800 125 201  1882 205 234  1861 291 136  3151 044 031	250 10 HBX250 250GTZ KZI-3	Mot. 678175->	
	11.77 - 12.84		 3151 095 043	KZI-3	->Chass. 4282707	
	09.63 - 12.84		3151 033 031	KZI-3	Chass. 4282708 - Mot. 678174	





















		CODE				
--	--	------	--	---	---	---











MERCEDES-BENZ

709								
LPKO 709 314.075 314.077	02.66 - 07.77	OM314.944, OM314.910		1800 125 201 ⊗ 1882 205 234 ⊗ 1861 291 136 ⊙ 3151 044 031	250 10 HBX250 250GTZ KZI-3	Mot. 410748->		
					3151 095 043 3151 033 031	KZI-3 KZI-3	->Chass. 4282707 Chass. 4282708 - Mot. 410747	
710								
L,LK,LS 710 323				1860 062 037 #	280 10 280Z	323		
LF,LAF,LPF 710 SA 015 052/01				1861 919 134	280 10 280GTZ			
711								
711 673.008 673.007 673.006	03.94 - 12.98	OM354.900		3482 008 038	310 MF310			
					1862 299 032	310 10 310WGSZ		
					3151 044 031	KZI-3		
711 673.308 673.306/307	03.96 - 12.98	OM904LA		3400 127 701 ☉	362 18 MF362			
				⊗ 3482 000 462	362WGTB			
				⊗ 1878 052 842				
				3400 700 484 HD ●	362 10			
				⊗ 3482 000 462	MF362			
				⊗ 1878 001 939	362WGTB			
				3151 170 131	KZIZ-3			
808								
LP 808, LPL 808 316.052 316.251/252 314.820 316.253 314.830 316.053 316.051	09.63 - 12.84	OM314		1800 125 201 ⊗ 1882 205 234 ⊗ 1861 291 136 ⊙ 3151 044 031	250 10 HBX250 250GTZ KZI-3	Mot. 410748-> 316.051-054/072/081-083/085-087		
					3151 095 043	KZI-3	->Chass. 4282707 316.051-054/072/081-083/085-087	
	LPK 808 316.072	10.69 - 10.77			3151 033 031	KZI-3	Chass. 4282708 - Mot. 410747 316.051-054/072/081-083/085-087	
LPKF 808, LPKF 809 316.082 316.081 316.083	10.69 - 10.77							
LPL 808 316.252/253 316.251		OM314		1800 125 201 ⊗ 1882 205 234 ⊗ 1861 291 136 ⊙ 3151 044 031	250 10 HBX250 250GTZ KZI-3	Mot. 678175-> 316.251-252-253		
				3151 033 031	KZI-3	->Mot. 678174 316.251-252-253		
809								
809 673.010 673.014 673.013 673.011/012 809 K 673.042	03.84 - 12.98	OM364		3482 046 031 #	280 MF280			
					1861 919 134	280 10 280GTZ		
	03.84 - 12.98				3482 008 038	310 MF310	für / for: SA24481-01 Sonderausführung / Special design (68) (56)	
						1861 303 248	310 10 310GSB	für / for: SA24481-01 Sonderausführung / Special design (68) (56)
						3151 044 031	KZI-3	

		CODE				
--	--	------	--	---	---	---

MERCEDES-BENZ

809						
LP 809, LPL 808, LPL 809 316.251 316.052/053 316.252/253 316.051 316.054	09.63 - 12.84	OM314		1800 125 201  1882 205 234  1861 291 136  3151 044 031	250 10 HBX250 250GTZ KZI-3	Mot. 410748-> 316.051-054/072/081-083/085-087
				1800 125 201  1882 205 234  1861 291 136  3151 044 031	250 10 HBX250 250GTZ KZI-3	Mot. 678175-> 316.251-252-253
				1882 205 234	250 HBX250	316.051-054/072/081-083/085-087/251-252-253
				1861 291 136	250 10 250GTZ	316.051-054/072/081-083/085-087/251-252-253
				3151 095 043	KZI-3	-> Chass. 4282707 316.051-054/072/081-083/085-087
				3151 033 031	KZI-3	Chass. 4282708 - Mot. 410747 316.051-054/072/081-083/085-087
				3151 033 031	KZI-3	-> Mot. 678174 316.251-252-253
LPK 809 316.072	11.77 - 12.84	OM314		1800 125 201  1882 205 234  1861 291 136  3151 044 031	250 10 HBX250 250GTZ KZI-3	Mot. 410748-> 316.051-054/072/081-083/085-087
				3151 095 043	KZI-3	-> Chass. 4282707 316.051-054/072/081-083/085-087
				3151 033 031	KZI-3	Chass. 4282708 - Mot. 410747 316.051-054/072/081-083/085-087
810						
L,LP 810				1861 919 134	280 10 280GTZ	-> Mot. 040605

























811						
811 318.072		OM353		1882 317 131	280 HVB280	318.072
				1861 919 134	280 10 280GTZ	318.072
				3151 095 043	KZI-3	318.072
811 673.015 673.018 673.016/017 673.019	03.94 - 12.98	OM364LA		3482 008 038	310 MF310	673.015-019/046
				1862 299 032	310 10 310WGSZ	673.015-019/046
811 K 673.046	03.94 - 12.98			3151 044 031	KZI-3	673.015-019/046
811 673.319 673.317/318 673.316 673.315	03.96 - 12.98	OM904LA		3400 121 401  3482 000 462  1878 052 842  3151 000 374	362 18 MF362 362WGTB KZIS-4	673.315-319/346
				1878 001 939 HD●	362 18 362WGTB	673.315-319/346

		CODE				
--	--	------	--	---	---	---

MERCEDES-BENZ





















811						
LP 811 318.051-053	10.69-02.73	OM352		1882 252 331	310 GFX310	->Chass. 922885 318.051-054
				1882 305 131	310 GFX310	Chass. 922886 - Mot. 393780 318.051-054
				1861 303 248	310 10 310GSB	Chass. 922886 - Mot. 393780 318.051-054
				3151 095 043	KZI-3	->Mot. 393780 318.051-054
				1882 317 131	280 HVB280	->Chass. 4282707 Mot. 393781-> 318.051-054
				1861 919 134	280 10 280GTZ	->Chass. 4282707 Mot. 393781-> 318.051-054
				3151 095 043	KZI-3	->Chass. 4282707 Mot. 393781-> 318.051-054
				1882 317 131	280 HVB280	Chass. 4282708-> 318.051-054
				1861 919 134	280 10 280GTZ	Chass. 4282708-> 318.051-054
				3151 033 031	KZI-3	Chass. 4282708 - Mot. 678174 318.051-054
				3151 044 031	KZI-3	Mot. 678175-> 318.051-054
LPK 811 318.072	03.73-12.84	OM352		1882 317 131	280 HVB280	Mot. 393781-> 318.072
				1861 919 134	280 10 280GTZ	Mot. 393781-> 318.072
				3151 033 031	KZI-3	Chass. 4282708 - Mot. 678174 318.072
				3151 044 031	KZI-3	Mot. 678175-> 318.072
				1882 252 331	310 GFX310	->Chass. 922885 318.072
				1882 305 131	310 GFX310	Chass. 922886 - Mot. 393780 318.072
				1861 303 248	310 10 310GSB	->Mot. 393780 318.072
				3151 095 043	KZI-3	318.072
LPS 811 318.070	10.69-02.73	OM352		1882 252 331	310 GFX310	->Chass. 922885 318.070
				1882 305 131	310 GFX310	Chass. 922886 - Mot. 393780 318.070
				1861 303 248	310 10 310GSB	->Mot. 393780 318.070
				3151 095 043	KZI-3	->Mot. 393780 318.070
				1882 317 131	280 HVB280	->Chass. 4282707 Mot. 393781-> 318.070
				1861 919 134	280 10 280GTZ	->Chass. 4282707 Mot. 393781-> 318.070
				3151 095 043	KZI-3	->Chass. 4282707 Mot. 393781-> 318.070
				1882 317 131	280 HVB280	Chass. 4282708-> 318.070
				1861 919 134	280 10 280GTZ	Chass. 4282708-> 318.070
				3151 033 031	KZI-3	Chass. 4282708 - Mot. 678174 318.070
				3151 044 031	KZI-3	Mot. 678175-> 318.070









MERCEDES-BENZ

813						
LP 813, LPL 813 318.052/053 318.254 318.251/252 318.054 318.253 318.051	09.63 - 12.84	OM352	 1882 317 131	280 HVB280	Mot. 393781-> 318.051-054	
			 1861 919 134	280 10 280GTZ	Mot. 393781-> 318.051-054	
			 3151 095 043	KZI-3	->Chass. 4282707 Mot. 393781-> 318.051-054	
			 3151 033 031	KZI-3	Chass. 4282708 - Mot. 678174 318.051-054	
			 3151 044 031	KZI-3	Mot. 678175-> 318.051-054	
			 1882 252 331	310 GFX310	->Chass. 922885 318.051-052-053-054	
			 1882 305 131	310 GFX310	Chass. 922886 - Mot. 393780 318.051-052-053-054	
			 1861 303 248	310 10 310GSB	318.051-052-053-054	
			 3151 095 043	KZI-3	->Mot. 393780 318.051-052-053-054	
			 3482 008 038	310 MF310	318.051-052-053-054 Sonderausführung / Special design	(56)
			 1861 303 248	310 10 310GSB	->Chass. 922885 318.051-052-053-054 Sonderausführung / Special design	(56)
			 3151 095 043	KZI-3	->Chass. 4282707 318.051-052-053-054	
			 3151 033 031	KZI-3	Chass. 4282708 - Mot. 678174 318.051-052-053-054	
			 3151 044 031	KZI-3	Mot. 678175-> 318.051-052-053-054	
LPK 813 318.072 LPS 813, LPLS 813 318.270 318.070 318.251/252 318.254	03.73 - 12.84	OM352	 1882 252 331	310 GFX310	->Chass. 922885 318.070/072	
	09.63 - 12.84		 1882 305 131	310 GFX310	Chass. 922886 - Mot. 393780 318.070/072	
			 1861 303 248	310 10 310GSB	->Mot. 393780 318.070/072	
			 3151 095 043	KZI-3	->Mot. 393780 318.070/072	
			 1882 317 131	280 HVB280	->Chass. 4282707 Mot. 393781-> 318.070/072	
			 1861 919 134	280 10 280GTZ	->Chass. 4282707 Mot. 393781-> 318.070/072	
			 3151 095 043	KZI-3	->Chass. 4282707 Mot. 393781-> 318.070/072	
			 1882 317 131	280 HVB280	Chass. 4282708-> 318.070/072	
			 1861 919 134	280 10 280GTZ	Chass. 4282708-> 318.070/072	
			 3151 033 031	KZI-3	Chass. 4282708 - Mot. 678174 318.070/072	
			 3151 044 031	KZI-3	Mot. 678175-> 318.070/072	

		CODE				
--	--	------	--	---	---	---





MERCEDES-BENZ







813						
LPL 813 318.251-254		OM353		1882 317 131	280 HVB280	Chass. 4367142-> 318.251-254
				1861 919 134	280 10 280GTZ	Chass. 4367142-> 318.251-254
				3151 033 031	KZI-3	Chass. 4367142 - Mot. 678174 318.251-254
				3151 044 031	KZI-3	Mot. 678175-> 318.251-254
			3482 008 038	310 MF310	318.251-254 Sonderausführung / Special design	(56)
			1861 303 248	310 10 310GSB	318.251-254 Sonderausführung / Special design	(56)
			3151 033 031	KZI-3	->Mot. 678174 318.251-254 Sonderausführung / Special design	(56)
			3151 044 031	KZI-3	Mot. 678175-> 318.251-254 Sonderausführung / Special design	(56)
LPLS 813 318.270		OM353		1882 317 131	280 HVB280	Chass. 4367142-> 318.270
				1861 919 134	280 10 280GTZ	Chass. 4367142-> 318.270
				3151 033 031	KZI-3	Chass. 4367142 - Mot. 678174 318.270
				3151 044 031	KZI-3	Mot. 678175-> 318.270
				1882 305 131	310 GFX310	318.270
				1861 303 248	310 10 310GSB	318.270
			1861 303 248 ●	310 10 310GSB	318.270	
			3151 033 031	KZI-3	->Mot. 678174 318.270	
			3151 044 031	KZI-3	Mot. 678175-> 318.270	
			3482 008 038	310 MF310	318.270 Sonderausführung / Special design	(56)
			1861 303 248	310 10 310GSB	318.270 Sonderausführung / Special design	(56)
			3151 033 031	KZI-3	->Mot. 678174 318.270 Sonderausführung / Special design	(56)
	3151 044 031	KZI-3	Mot. 678175-> 318.270 Sonderausführung / Special design	(56)		













814						
814 F 674.082 674.090 674.080/081	05.86 - 12.98	OM366		3400 122 401	310 10 MF310	674.010-014/042/052/080-082/212-213-214
	03.84 - 12.98			3482 008 038	310WGSZ	
			1861 964 034	KZI-3		
814 K 674.042	03.84 - 12.98	OM364LA, 366		3400 124 301	330 10 GMF330	674.010-019/042/046/052/056/085-087/090 /212-214/217-219
814 S 674.052	01.84 - 12.98			3482 012 211	330WGSZ	
814,814L 674.010 674.013/014 674.214 674.012 674.212 674.011 674.213				3151 044 031	KZI-3	
814 F 674.385-387	03.96 - 12.98	OM904LA		3400 121 401	362 18 MF362	674.417-419/477-478/315-319/346/356/385-387
	03.96 - 12.98			3482 000 462	362WGTB	
	03.96 - 12.98			1878 052 842	KZIS-4	
	03.96 - 12.98			3151 000 958	Getr. / GBox: ZF	
814 K 674.346	03.96 - 12.98			3400 127 701 ●	362 18 MF362	674.417-419/477-478/315-319/346/356/385-387
814 S 674.356	03.96 - 12.98			3482 000 462	362WGTB	674.417-419/477-478/315-319/346/356/385-387
814,814L 674.417 674.419 674.418 674.318 674.316/317 674.315 674.319				1878 052 842		
				3400 700 484 HD ●	362 10 MF362	
				3482 000 462	362WGTB	
				1878 001 939		

		CODE					
--	--	------	--	--	---	---	---

















MERCEDES-BENZ

814							
814 F 674.085 674.087 674.086	03.94 - 12.98	OM364LA		3482 008 038	310 MF310	674.085-087/217/219/015-019/046/056	
814 K 674.046	03.94 - 12.98			1862 299 032	310 10 310WGSZ	674.085-087/217/219/015-019/046/056	
814 S 674.056	03.94 - 12.98			3151 044 031	KZI-3	674.085-087/217/219/015-019/046/056	
814,814 L 674.218/219 674.017 674.015 674.018 674.016 674.217 674.019	01.84 - 12.98	OM364LA, 366		3400 124 301 ⊗ 3482 012 211 ⊗ 1861 963 033 ⊙ 3151 044 031	330 10 GMF330 330WGSZ KZI-3	674.085-087/212-214/217-219/010-019/042/046 /052/056	































817							
817 F 676.083 676.082 676.081 676.084 676.080 676.085	03.84 - 12.98	OM366A, LA		3482 012 240	330 GMF330		
817 K 676.040 676.046	01.86 - 12.98			1861 963 033	330 10 330WGSZ		
817 S,817 LS 676.251 676.060 676.258 676.050 676.250 676.051	01.84 - 12.98	OM366A		3482 051 131 #	350 GMF350X	Getr. / GBox: G4	
817,817 L 676.067/068 676.201 676.203/204 676.066 676.206 676.003/004 676.208 676.069 676.207 676.002 676.209 676.202 676.001	01.84 - 12.98			1878 001 144	350 10 350WGTZ	Getr. / GBox: G4	
				3151 000 374	KZIS-4	Getr. / GBox: G4	
817 F 676.383-385	03.96 - 12.98	OM904LA		3400 121 401 ⊗ 3482 000 462 ⊗ 1878 052 842 ⊙ 3151 000 374	362 18 MF362 362WGTB KZIS-4	676.406-409/458/464/346/360/366-369/383-385	
817 K 676.346	03.96 - 12.98			1878 001 939 HD	362 18 362WGTB	676.406-409/458/464/346/360/366-369/383-385	
817 S,817 LS 676.360 676.458	03.96 - 12.98						
817,817 L 676.369 676.368 676.406 676.409 676.367 676.408 676.366 676.407	03.96 - 12.98						

911							
L,LA 911				1882 201 132	295 GF295	Sonderausführung / Special design	(56)
				1861 279 133	295 10 295GTZ	Sonderausführung / Special design	(56)
				3151 095 043	KZI-3	Sonderausführung / Special design	(56)
L,LA LP 911				1861 919 134	280 10 280GTZ	Sonderausführung / Special design	(56)
L,LP 911				1861 919 134	280 10 280GTZ	->Mot. 040605	
		OM352		1861 919 134	280 10 280GTZ	Sonderausführung / Special design	(56)
				3151 095 043	KZI-3	Sonderausführung / Special design	(56)
LA 911				1860 062 037 #	280 10 280Z		
LA,LK 911 B LAK,LAF,LAKO 911 B		OM353		1861 919 134	280 10 280GTZ	->Chass. 760271 nicht für Fahrgestellnummer / not for chassis no.: 500001-599999	(97)
				3151 095 043	KZI-3	->Chass. 760271 nicht für Fahrgestellnummer / not for chassis no.: 500001-599999	(97)
				1882 201 132	295 GF295	Chass. 760272-> Chass. 500001 - Chass. 599999	
				1861 279 133	295 10 295GTZ	Chass. 760272-> Chass. 500001 - Chass. 599999	
				3151 095 043	KZI-3	Chass. 760272-> Chass. 500001 - Chass. 599999	

MERCEDES-BENZ





















911							
LAS 911 B LS 911 B		OM353	 1861 919 134	280 10 280GTZ	->Chass. 760271 nicht für Fahrgestellnummer / not for chassis no.: 500001-599999	(97)	
			 3151 095 043	KZI-3	->Chass. 760271 nicht für Fahrgestellnummer / not for chassis no.: 500001-599999	(97)	
			 1882 201 132	295 GF295	Chass. 760272-> Chass. 500001 - Chass. 599999		
			 1861 279 133	295 10 295GTZ	Chass. 760272-> Chass. 500001 - Chass. 599999		
			 3151 095 043	KZI-3			
LP 911 B 353.053 353.058 353.056 353.052 353.057 353.051 353.054	01.67 - 03.77	OM352.907, OM352.986	 1861 919 134	280 10 280GTZ	->Mot. 040605		
			 1882 201 132	295 GF295	Mot. 040606->		
			 1861 279 133	295 10 295GTZ	Mot. 040606->		
			 3151 095 043	KZI-3	Mot. 040606->		
			OM352A	 1882 252 333	310 GFX310		
				 1861 303 248	310 10 310GSB		
LPK 911 B LPS 911 B		OM353	 1861 919 134	280 10 280GTZ			
			 3151 095 043	KZI-3			
LT 911 B		OM353	 1882 305 131	310 GFX310			
			 1861 303 248	310 10 310GSB			
			 1861 303 248 ●	310 10 310GSB			
			 3151 095 043	KZI-3			

MERCEDES-BENZ

913						
LP 913, LPL 913 318.058/059 318.056 318.256-258 318.057	09.63 - 12.84	OM352	 1882 252 331	310 GFX310	->Chass. 922885 318.056-059	
			 1882 305 131	310 GFX310	Chass. 922886 - Mot. 393780 318.056-059	
			 1861 303 248	310 10 310GSB	->Mot. 393780 318.056-059	
			 3151 095 043	KZI-3	->Mot. 393780 318.056-059	
			 1882 317 131	280 HVB280	->Chass. 4282707 Mot. 393781-> 318.056-059	
			 1861 919 134	280 10 280GTZ	->Chass. 4282707 Mot. 393781-> 318.056-059	
			 3151 095 043	KZI-3	->Chass. 4282707 Mot. 393781-> 318.056-059	
			 1882 317 131	280 HVB280	Chass. 4282708-> 318.056-059	
			 1861 919 134	280 10 280GTZ	Chass. 4282708-> 318.056-059	
			 3151 033 031	KZI-3	Chass. 4282708 - Mot. 678174 318.056-059	
			 3151 044 031	KZI-3	Mot. 678175-> 318.056-059	
			OM353	 1882 317 131	280 HVB280	Chass. 4367142-> 318.256-257-258
	 1861 919 134	280 10 280GTZ		Chass. 4367142-> 318.256-257-258		
	 3151 033 031	KZI-3		Chass. 4367142 - Mot. 678174 318.256-257-258		
	 3151 044 031	KZI-3		Mot. 678175-> 318.256-257-258		
	OM353.982, OM353.965, OM353.981, OM353.904	 1861 303 248	310 10 310GSB	318.256-257-258 Sonderausführung / Special design	(56)	
		 3482 008 038	310 MF310	318.256-257-258 Sonderausführung / Special design	(56)	
		 3151 033 031	KZI-3	->Mot. 678174 318.256-257-258 Sonderausführung / Special design	(56)	
		 3151 044 031	KZI-3	Mot. 678175-> 318.256-257-258 Sonderausführung / Special design	(56)	
	LPK 913 318.092 LPS 913 318.090	01.67 - 12.84	OM352	 1882 252 331	310 GFX310	->Chass. 922885 318.090/092
10.69 - 12.84		 1882 305 131	310 GFX310	Chass. 922886 - Mot. 393780 318.090/092		
		 1861 303 248	310 10 310GSB	->Mot. 393780 318.090/092		
		 3151 095 043	KZI-3	->Mot. 393780 318.090/092		
		 1882 317 131	280 HVB280	->Chass. 4282707 Mot. 393781-> 318.090/092		
		 1861 919 134	280 10 280GTZ	->Chass. 4282707 Mot. 393781-> 318.090/092		
		 3151 095 043	KZI-3	->Chass. 4282707 Mot. 393781-> 318.090/092		
		 1882 317 131	280 HVB280	Chass. 4282708-> 318.090/092		
		 1861 919 134	280 10 280GTZ	Chass. 4282708-> 318.090/092		
		 3151 033 031	KZI-3	Chass. 4282708 - Mot. 678174 318.090/092		
		 3151 044 031	KZI-3	Mot. 678175-> 318.090/092		































		CODE				
--	--	------	--	---	---	---

MERCEDES-BENZ

914						
914 678.003 674.021/022 674.024 678.002 678.006 678.008 674.023	03.84 - 12.98	OM366	 3400 122 401 ⊗ 3482 008 038 ⊗ 1861 964 034 ⊙ 3151 044 031	310 10 MF310 310WGSZ KZI-3		
914 AK 674.145 674.144	02.87 - 12.98		 3400 124 301 ⊗ 3482 012 211 ⊗ 1861 963 033 ⊙ 3151 044 031	330 10 GMF330 330WGSZ KZI-3		
914 AK 674.144	02.87 - 12.98					
914 K 674.044	03.84 - 12.98					
914 KO 674.090	01.87 - 12.98					
917						
917 676.307/308 676.306 676.309	03.96 - 12.98	OM904LA	 3400 121 401 ⊗ 3482 000 462 ⊗ 1878 052 842 ⊙ 3151 000 374	362 18 MF362 362WGTB KZIS-4	676.306-309/341/390	
917 K 676.341	03.96 - 12.98					
917 KO 676.390	03.96 - 12.98		 1878 001 939 HD●	362 18 362WGTB	676.306-309/341/390	
917 676.006 676.008/009 676.007	03.94 - 12.98	OM366A, LA	 3482 012 240	330 GMF330	676.143/182-185/195-196-197-198/006-009/041 /090/142	
917 AF 676.197 676.182 676.198 676.196 676.185 676.195 676.184 676.183	02.87 - 12.98		 1861 963 033	330 10 330WGSZ	676.143/182-185/195-196-197-198/006-009/041 /090/142	
917 AK 676.142/143	03.94 - 12.98		 3151 044 031	KZI-3	676.143/182-185/195-196-197-198/006-009/041 /090/142	
917 K 676.041	03.94 - 12.98					
917 KO 676.090	03.94 - 12.98					
917 AK 674.144		OM366	 3400 122 401 ⊗ 3482 008 038 ⊗ 1861 964 034 ⊙ 3151 044 031	310 10 MF310 310WGSZ KZI-3	674.144	
1013						
1013 380.005 380.007 380.003/004 380.002 380.008	02.76 - 12.84	OM353	 1882 317 131	280 HVB280	->Chass. 4276890 380.002-003/005/007	
			 1861 919 134	280 10 280GTZ	->Chass. 4276890 380.002-003/005/007	
			 3151 033 031	KZI-3	->Chass. 4696330 380.002-003/005/007	
			 3482 008 038	310 MF310	Chass. 4276891-> 380.002-003-004-005/007-008	
			 1861 303 248	310 10 310GSB	Chass. 4276891 - Chass. 4696330 380.002-003-004-005/007-008	
			 3151 044 031	KZI-3	Chass. 4696331-> 380.002-003/005/007/004/008	
1013 A 380.102 380.104 380.103	02.76 - 12.86	OM353	 1882 317 131	280 HVB280	->Chass. 4276890 380.102-103	
			 1861 919 134	280 10 280GTZ	->Chass. 4276890 380.102-103	
			 3151 033 031	KZI-3	->Chass. 4696330 380.102-103	
			 3482 008 038	310 MF310	Chass. 4276891-> 380.102-103-104	
			 1861 303 248	310 10 310GSB	Chass. 4276891-> 380.102-103-104	
			 3151 044 031	KZI-3	Chass. 4696331-> 380.102-103-104	

































		CODE				
--	--	------	--	---	---	---

MERCEDES-BENZ

1013							
1013 AK 380.140 1013 K 380.040	02.76 - 12.84	OM353		1882 317 131	280 HVB280	->Chass. 4276890	
	02.76 - 12.84			1861 919 134	280 10 280GTZ	->Chass. 4276890	
				3151 033 031	KZI-3	->Chass. 4276890	
				3482 008 038	310 MF310	Chass. 4276891->	
				1861 303 248	310 10 310GSB	Chass. 4276891->	
				3151 033 031	KZI-3	Chass. 4276891 - Chass. 4696330	
				3151 044 031	KZI-3	Chass. 4696331->	
1013 B 358.066 358.071 358.053 358.062 358.065 358.072 358.051 358.050 358.064 358.063 358.052 358.054		OM352		1861 919 134	280 10 280GTZ	->Chass. 760271 358.050-054/062-066/071-072	
				3151 095 043	KZI-3	->Chass. 760271 358.050-054/062-066/071-072	
				1882 201 132	295 GF295	Chass. 760272-> 358.050-054/062-066/071-072	
				1861 279 133	295 10 295GTZ	Chass. 760272-> 358.050-054/062-066/071-072	
				3151 095 043	KZI-3	Chass. 760272-> 358.050-054/062-066/071-072	
				1882 305 132	310 GFX310	358.050-054/062-066/071-072 Sonderausführung / Special design	(56)
				1861 303 248	310 10 310GSB	358.050-054/062-066/071-072 Sonderausführung / Special design	(56)
				3151 095 043	KZI-3	358.050-054/062-066/071-072 Sonderausführung / Special design	(56)
1013 KO 380.061 380.060	02.76 - 12.84	OM353		3482 008 038	310 MF310	380.060-061	
				1861 303 248	310 10 310GSB	380.060-061	
				3151 044 031	KZI-3	380.060-061	
1013 S 380.050 380.053	02.76 - 12.84	OM353		3482 008 038	310 MF310	380.050/053	
				1861 303 248	310 10 310GSB	380.050/053	
				3151 044 031	KZI-3	380.050/053	
LP 1013 318.354 LP 1013, LPL 1013 318.353 318.352 318.354 318.552 318.551 318.351 LPK 1013 318.392 318.372	11.76 - 12.84	OM353		1882 317 131	280 HVB280	318.351-354/372/551-552	
	11.76 - 12.84			1861 919 134	280 10 280GTZ	318.351-354/372/551-552	
	11.76 - 12.84			3151 033 031	KZI-3	->Mot. 678174 318.351-354/372/551-552	
				3151 044 031	KZI-3	Mot. 678175-> 318.351-354/372/551-552	
				3482 008 038	310 MF310	318.351-354/372 Sonderausführung / Special design	(56)
				1861 303 248	310 10 310GSB	318.351-354/372 Sonderausführung / Special design	(56)
				3151 033 031	KZI-3	->Mot. 678174 318.351-354/372 Sonderausführung / Special design	(56)
				3151 044 031	KZI-3	Mot. 678175-> 318.351-354/372 Sonderausführung / Special design	(56)
					1882 305 131	310 GFX310	
		1861 303 248	310 10 310GSB				



















		CODE				
--	--	------	--	---	---	---







MERCEDES-BENZ







1017							
1017 380.012/013 380.018 380.015 380.014 380.017	11.75 - 02.91	OM353	 3482 008 038	310 MF310	->Chass. 4275350 380.012-013-014-015/017-018		
			 1861 303 248	310 10 310GSB	->Chass. 4275350 380.012-013-014-015/017-018		
			 3151 044 031	KZI-3	->Chass. 4275350 380.012-013-014-015/017-018		
			 3482 012 211	330 GMF330	Chass. 4275351-> 380.012-013/015/017-018		
			 1861 571 236	330 10 330GSZ	Chass. 4275351-> 380.012-013/015/017-018		
			 3151 044 031	KZI-3	Chass. 4275351-> 380.012-013/015/017-018		
	OM353.951	 3482 012 211	330 GMF330	Chass. 4275670-> für / for: Turbo	(68)		
		 1861 571 236	330 10 330GSZ	Chass. 4275670-> für / for: Turbo	(68)		
		 3151 044 031	KZI-3	Chass. 4275670-> für / for: Turbo	(68)		
1017 A 380.114 380.112/113	11.75 - 02.91	OM353	 3482 008 038	310 MF310	->Chass. 4275350 380.112-113-114		
			 1861 303 248	310 10 310GSB	->Chass. 4275350 380.112-113-114		
			 3151 044 031	KZI-3	->Chass. 4275350 380.112-113-114		
			 3482 012 211	330 GMF330	Chass. 4275351-> 380.112-113-114		
			 1861 571 236	330 10 330GSZ	Chass. 4275351-> 380.112-113-114		
			 3151 044 031	KZI-3	Chass. 4275351-> 380.112-113-114		
	OM352A	 3482 012 211	330 GMF330	06.1977->			
		 1861 571 236	330 10 330GSZ	06.1977->			
		 3151 033 031	KZI-3	06.1977->			
1017 AF 380.180/181	11.75 - 09.85	OM353	 3482 008 038	310 MF310	->Chass. 4275350 380.180-181		
			 1861 303 248	310 10 310GSB	->Chass. 4275350 380.180-181		
			 3151 044 031	KZI-3	->Chass. 4275350 380.180-181		
			 3482 012 211	330 GMF330	Chass. 4275351-> 380.180-181		
			 1861 571 236	330 10 330GSZ	Chass. 4275351-> 380.180-181		
			 3151 044 031	KZI-3	Chass. 4275351-> 380.180-181		
1017 AK 380.143 1017 AS 380.151 1017 K 380.043	02.76 - 12.84	OM353	 3482 008 038	310 MF310	->Chass. 4275350 380.043/143/151		
	04.77 - 09.85		 1861 303 248	310 10 310GSB	->Chass. 4275350 380.043/143/151		
	02.76 - 12.84		 3151 044 031	KZI-3	->Chass. 4275350 380.043/143/151		
			 3482 012 211	330 GMF330	Chass. 4275351-> 380.043/143/151		
			 1861 571 236	330 10 330GSZ	Chass. 4275351-> 380.043/143/151		
			 3151 044 031	KZI-3	Chass. 4275351-> 380.043/143/151		
			OM352A	 3482 012 211	330 GMF330	06.1977->	
				 1861 571 236	330 10 330GSZ	06.1977->	
	 3151 033 031			KZI-3	06.1977->		

		CODE				
--	--	------	--	---	---	---







































MERCEDES-BENZ

1017						
1017 KO,1017 F 380.065/066 380.080/081	08.73 - 09.96	OM353		3482 008 038	310 MF310	->Chass. 4275350 380.065-066/180-181
				1861 303 248	310 10 310GSB	->Chass. 4275350 380.065-066/180-181
				3151 044 031	KZI-3	->Chass. 4275350 380.065-066/180-181
				3482 012 211	330 GMF330	Chass. 4275351-> 380.065-066/180-181
				1861 571 236	330 10 330GSZ	Chass. 4275351-> 380.065-066/180-181
				3151 044 031	KZI-3	Chass. 4275351-> 380.065-066/180-181
1017 S,1017 LS 380.052 380.051 380.251/252	08.73 - 09.96	OM353		3482 008 038	310 MF310	->Chass. 4275350 380.051-052
				1861 303 248	310 10 310GSB	->Chass. 4275350 380.051-052
				3151 044 031	KZI-3	->Chass. 4275350 380.051-052
				3482 012 211	330 GMF330	Chass. 4275351-> 380.051-052
				1861 571 236	330 10 330GSZ	Chass. 4275351-> 380.051-052
				3151 044 031	KZI-3	Chass. 4275351-> 380.051-052
				3482 012 211	330 GMF330	Chass. 4275670-> 380.251-252
				1861 571 236	330 10 330GSZ	Chass. 4275670-> 380.251-252
				3151 044 031	KZI-3	Chass. 4275670-> 380.251-252
		OM352A		3482 012 211	330 GMF330	06.1977->
				1861 571 236	330 10 330GSZ	06.1977->
				3151 033 031	KZI-3	06.1977->

1019							
1019 AF 380.183 1019 AF 380.183 1019 F 380.083	01.79 - 12.82	OM401		3482 011 331 #	360 GMF360	380.083/183	
				3482 000 953	350 GMF350X	380.083/183	
	01.79 - 12.82				1878 001 070	350 10 350GTZ	380.083/183
					3151 043 031	KZI-4,5	380.083/183
	01.79 - 12.82				1882 302 131	380 GF380	380.183 Sonderausführung / Special design
					1878 000 105	380 10 380GTZ	380.183 Sonderausführung / Special design
					3151 000 375	KZIS-4	380.183 Sonderausführung / Special design



































1113						
L,LA 1113 SA 016 655/2				1882 201 132	295 GF295	
				1861 279 133	295 10 295GTZ	
				3151 095 043	KZI-3	
L,LA,LK,LP,LS 1113 B LAK,LAS,LPK,LPS 1113 B		OM358		1861 919 134	280 10 280GTZ	->Chass. 760271 nicht für Fahrgestellnummer / not for chassis no.: 500001-599999
				1882 201 132	295 GF295	Chass. 760272-> Chass. 500001 - Chass. 599999
				1861 279 133	295 10 295GTZ	Chass. 760272-> Chass. 500001 - Chass. 599999
				3151 095 043	KZI-3	

MERCEDES-BENZ

1113						
L,LA,LP 1113			 1861 919 134	280 10		
			 3151 095 043	280GTZ KZI-3		
L,LA,LP 1113 B		OM352A	 1882 252 333	310		
			 1861 303 248	GFX310 310 10 310GSB		
L,LK,LS,LKO 1113 B 358.010-015 358.000-004 358.021-023		OM352, 353	 1861 919 134	280 10	->Chass. 760271	
			 1882 201 132	280GTZ 295 GF295	358.000-004/010-015/021-023 nicht für Fahrgestellnummer / not for chassis no.: 500001-599999	(97)
			 1861 279 133	295 10 295GTZ	Chass. 760272-> Chass. 500001 - Chass. 599999 358.000-004/010-015/021-023	
			 3151 095 043	KZI-3	Chass. 760272-> Chass. 500001 - Chass. 599999 358.000-004/010-015/021-023	
LF,LAF 1113 B 358.116 358.016-117		OM352, 353	 1882 252 333	310	->Chass. 922885	
			 1882 305 132	GFX310 310 GFX310	358.016-018/116-117 Chass. 922886-> 358.016-018/116-117	
			 1861 303 248	310 10 310GSB	358.016-018/116-117	
			 3151 095 043	KZI-3	358.016-018/116-117	
LP 1113, LPL 1113 318.358 318.556 318.359 318.557 318.356/357	01.80 - 12.84	OM353	 3482 008 038	310	318.356-359/392	
			 1861 303 248	MF310 310 10 310GSB	318.356-359/392	
			 3151 033 031	KZI-3	->Mot. 678174 318.356-359/392	
			 3151 044 031	KZI-3	Mot. 678175-> 318.356-359/392	
LP,LPK,LPS,LPF 1113 358.072 358.071 358.050-054 358.062-066		OM352	 1882 305 132	310	358.050-054/062-066/071-072 Sonderausführung / Special design	(56)
			 1861 303 248	GFX310 310 10 310GSB	358.050-054/062-066/071-072 Sonderausführung / Special design	(56)
			 3151 095 043	KZI-3	358.050-054/062-066/071-072 Sonderausführung / Special design	(56)
1114						
1114,1114 L 675.013 675.212 678.013 675.012 675.213/214 678.016 675.014 678.012 678.018	01.84 - 12.98	OM366	 3400 122 401	310 10	675.012-013-014/212-213-214	
			 3482 008 038  1861 964 034  3151 044 031	MF310 310WGSZ KZI-3	678.013	
1114 A 678.118 678.162 678.112 678.116 678.161	02.87 - 12.98	OM366	 3400 124 301	330 10	675.012-013-014/212-213-214	
			 3482 012 211  1861 963 033  3151 044 031	GMF330 330WGSZ KZI-3		
1114 AK 675.143 678.116 675.142	02.87 - 12.98	OM366	 3400 122 401	310 10	678.116	
			 3482 008 038  1861 964 034  3151 044 031	MF310 310WGSZ KZI-3		
1114 K 675.042 1114 S 675.053 675.052	03.84 - 12.98	OM366	 3400 122 401	310 10	675.142-143 678.116	
			 3482 008 038  1861 964 034  3151 044 031	MF310 310WGSZ KZI-3		
			 3400 124 301	330 10		
			 3482 012 211  1861 963 033  3151 044 031	GMF330 330WGSZ KZI-3		





		CODE				
--	--	------	--	---	---	---



MERCEDES-BENZ





1117								
1117,1117 L 676.014 676.016 678.026 676.213/214 676.217-219 676.017 676.019 676.018 678.023 678.028 678.022 676.212 676.012/013 676.015	01.84 - 12.98	OM366, A	 3482 012 240	330 GMF330	678.023 676.012-019/212-214/217-219			
			 1861 963 033	330 10 330WGSZ	676.012-019/212-214/217-219 678.023			
			 3151 044 031	KZI-3	676.012-019/212-214/217-219 678.023			
			OM366	 3482 051 131 #	350 GMF350X	Getr. / GBox: G4 676.212-214/012-015 Sonderausführung / Special design	(56)	
				 1878 001 144	350 10 350WGTZ	Getr. / GBox: G4 676.212-214/012-015 Sonderausführung / Special design	(56)	
				 3151 000 374	KZIS-4	Getr. / GBox: G4 676.212-214/012-015 Sonderausführung / Special design	(56)	
1117,1117 L 676.316-318 676.418/419 676.319 676.417 1117 K 676.347 1117 S 676.354/355 676.454/455	03.96 - 12.98	OM904LA	 3400 121 401	362 18 MF362 362WGTB	676.316-319/347/354-355/417-419/454-455/476			
	03.96 - 12.98		 3482 000 462	 1878 052 842				
	03.96 - 12.98		 3151 000 374	3400 700 484 HD	362 10 KZIS-4	676.316-319/347/354-355/417-419/454-455/476		
				 3482 000 462	 1878 001 939			
1117 A 676.117 678.171 676.112 678.122 678.172 678.126 1117 AK 676.145 676.144	06.87 - 12.98	OM366	 3482 012 240	330 GMF330	676.112/144-145			
	04.84 - 12.98		 1861 963 033	330 10 330WGSZ	676.112/144-145			
			 3151 044 031	KZI-3	676.112/144-145			
1117 K 676.042 676.047 1117 S,1117 LS 676.055 676.053 676.253/254 676.052 676.054 676.252 676.255	04.84 - 12.98	OM366	 3482 012 240	330 GMF330	676.252-255/042			
	01.84 - 12.98		 1861 963 033	330 10 330WGSZ	676.252-255/042			
			 3151 044 031	KZI-3	676.252-255/042			
			 3482 051 131 #	350 GMF350X	Getr. / GBox: G4 676.052-053/252-253/042 Sonderausführung / Special design	(56)		
			 1878 001 144	350 10 350WGTZ	Getr. / GBox: G4 676.252-253/042 Sonderausführung / Special design	(56)		
			 3151 000 374	KZIS-4	Getr. / GBox: G4 676.252-253/042 Sonderausführung / Special design	(56)		
1120								
1120,1120 L 677.013 677.218 677.012 677.014 677.018 677.216/217 677.019 677.212/213 677.017 677.214 677.016 677.015	01.84 - 12.98	OM366, 366LA	 3482 051 131 #	350 GMF350X	677.012-019			
			 1878 001 070	350 10 350GTZ	677.012-019			
			 3151 000 374	KZIS-4	677.012-019			
				OM366LA	 3482 051 131 #	350 GMF350X	677.212-213-214	
					 1878 001 070	350 10 350GTZ	677.212-213-214	
					 3151 000 374	KZIS-4	677.212-213-214	
					 1882 166 737	380 GF380	677.216-218	
					 1878 000 105	380 10 380GTZ	677.216-218	
		 3151 000 374	KZIS-4	677.216-218				
1120 AF 677.183 677.196 1120 F 677.083 1120 L 677.212	02.87 - 12.98	OM366LA	 3400 125 001	350 10 GMF350X				
	02.90 - 12.98		 3482 000 953	 1878 001 070				
	08.84 - 12.98		 3151 000 374	KZIS-4				













		CODE				
--	--	------	--	---	---	---

MERCEDES-BENZ

1120							
1120 S,1120 LS 677.052 677.050 677.252/253 677.051 677.053 677.250/251	01.84 - 12.98	OM366, LA		3400 125 001 ● 3482 000 953 ● 1878 001 070 ● 3151 000 374	350 10 GMF350X 350GTZ KZIS-4	677.052-053/252-253	
		OM366LA		1882 166 737	380 GF380	677.250-251	
					1878 000 105	380 10 380GTZ	677.250-251
					3151 000 374	KZIS-4	677.250-251

1121						
1121 L 677.212		OM366LA		3482 051 131 #	350 GMF350X	677.212
				1878 001 070	350 10 350GTZ	677.212
				3151 000 374	KZIS-4	677.212
L,LA,LP,LAP 321 SA 015 052/01				1861 919 134	280 10 280GTZ	

















1124						
1124 AF 677.184 677.196 677.183 677.197	03.92 - 12.98	OM366LA		3400 125 001 ● 3482 000 953 ● 1878 001 070 ● 3151 000 374	350 10 GMF350X 350GTZ KZIS-4	->Chass. K062275 677.183/196
				3400 125 001 ● 3482 000 953 ● 1878 001 070 ● 3151 000 374	350 10 GMF350X 350GTZ KZIS-4	Chass. K062276-> 677.183/196/184
1124 F 677.083/084	03.92 - 12.98	OM366LA		3400 125 001 ● 3482 000 953 ● 1878 001 070 ● 3151 000 374	350 10 GMF350X 350GTZ KZIS-4	->Chass. 5906887 677.083
				3400 125 001 ● 3482 000 953 ● 1878 001 070 ● 3151 000 374	350 10 GMF350X 350GTZ KZIS-4	Chass. 5906888-> 677.083-084

1213						
1213 381.007 381.002 381.005 381.008 381.003 1213 A 381.102-104 1213 K 381.040 1213 S 381.050	09.75 - 05.86	OM353.943, OM353.944, OM353.946, OM353.945		3482 008 038	310 MF310	->Chass. 4696330 381.102-103-104/002-003/005/007-008/040/050
	09.75 - 05.86			1861 303 248	310 10 310GSB	->Chass. 4696330 381.102-103-104/002-003/005/007-008/040/050
	09.75 - 05.86			3151 033 031	KZI-3	->Chass. 4696330 381.102-103-104/002-003/005/007-008/040/050
1213 AK 381.140 1213 AKO 381.160/161 1213 KO 381.060/061	09.75 - 05.86	OM353.943, OM353.944, OM353.946, OM353.945		3482 008 038	310 MF310	381.060-061/140/150/160-161
	09.75 - 05.86			1861 303 248	310 10 310GSB	381.060-061/140/150/160-161
	09.75 - 05.86			3151 033 031	KZI-3	381.060-061/140/150/160-161
				3151 044 031	KZI-3	Chass. 4696331-> 381.060-061/140/150/160-161
1213 AS 381.150	09.75 - 05.86	OM353.943, OM353.944, OM353.946, OM353.945		3482 008 038	310 MF310	381.060-061/140/150/160-161
				1861 303 248	310 10 310GSB	381.060-061/140/150/160-161
				3151 033 031	KZI-3	381.060-061/140/150/160-161
1213 K.S.A 381.160 381.060/061 381.150 381.140 381.161				3482 008 038	310 MF310	Chass. 4696331-> 381.060-061/140/150/160-161
				1861 303 248	310 10 310GSB	Chass. 4696331-> 381.060-061/140/150/160-161
				3151 044 031	KZI-3	Chass. 4696331-> 381.060-061/140/150/160-161





		CODE				
--	--	------	--	---	---	---

MERCEDES-BENZ









1213

L,LA,LP,LS 1213		OM352		1882 201 132	295 GF295		
				1861 279 133	295 10 295GTZ		
				3151 095 043	KZI-3		
LP,LPK 1213 352.050-054 352.063 352.062 352.071/072		OM352		1882 305 132	310 GFX310	352.050-054/062-063/071-072 Sonderausführung / Special design	(56)
				1861 303 248	310 10 310GSB	352.050-054/062-063/071-072 Sonderausführung / Special design	(56)
				3151 095 043	KZI-3	352.050-054/062-063/071-072 Sonderausführung / Special design	(56)
LP,LPK,LPS 1213 352.062-065 352.050-054 352.071/072		OM352		1882 201 132	295 GF295	->Chass. 760271 352.050-054/062-065/071-072	
				1861 279 133	295 10 295GTZ	->Chass. 760271 352.050-054/062-065/071-072	
				3151 095 043	KZI-3	->Chass. 760271 352.050-054/062-065/071-072	
				1882 252 331	310 GFX310	Chass. 760272 - Chass. 922885 352.050-054/062-065/071-072	
				1882 305 131	310 GFX310	Chass. 922886-> 352.050-054/062-065/071-072	
				1861 303 248	310 10 310GSB	Chass. 760272-> 352.050-054/062-065/071-072	
				3151 095 043	KZI-3	Chass. 760272-> 352.050-054/062-065/071-072	
				1882 252 333	310 GFX310	->Chass. 922885 352.050-054/062-065/071-072 Sonderausführung / Special design	(56)
				1882 305 132	310 GFX310	Chass. 922886-> 352.050-054/062-065/071-072 Sonderausführung / Special design	(56)
				1861 303 248	310 10 310GSB	352.050-054/062-065/071-072 Sonderausführung / Special design	(56)
				3151 095 043	KZI-3	352.050-054/062-065/071-072 Sonderausführung / Special design	(56)



1214

1214 A 615.241	01.84 - 12.98	OM366		3400 122 401  3482 008 038  1861 964 034  3151 044 031	310 10 MF310 310WGSZ KZI-3	615.241-242	
--------------------------	---------------	-------	---	--	--	-------------	--

1216





























LP 1216	06.69 -	OM324		1882 234 433	350 GF350		
				1878 001 074	350 10 350GTZ		
				3151 044 031	KZI-3		
LP 1216	-05.69	OM324		1878 001 074	350 10 350GTZ		
LP,LPK,LPS,LPKO 1216 352.082-087 352.091-093 352.055-059		OM327		1882 234 433	350 GF350	352.055-059/082-087/091-093	
				1878 001 074	350 10 350GTZ	352.055-059/082-087/091-093	
				3151 094 041	KZI-4	352.055-059/082-087/091-093	
LP,LPKO 1216		OM352		1878 001 074	350 10 350GTZ		

1217

1217 Turbo-Mot. 353.951		OM353		3482 012 211	330 GMF330	Chass. 4275670-> 353.951 Turbo	
				1861 571 236	330 10 330GSZ	Chass. 4275670-> 353.951 Turbo	
				3151 044 031	KZI-3	Chass. 4275670-> 353.951 Turbo	









		CODE				
--	--	------	--	---	---	---























MERCEDES-BENZ

1217							
1217,1217 L 381.015 381.018 381.212 381.215 381.213 381.218 381.012 381.017 381.217 381.013 1217 A 381.112-114 1217 AK 381.143 1217 AS 381.151 1217 K 381.043 1217 S,1217 LS 381.251 381.051 381.252 381.052	08.73 - 09.96	OM353		3482 008 038	310 MF310	->Chass. 4275669	
					1861 303 248	310 10 310GSB	->Chass. 4275669
					3151 044 031	KZI-3	->Chass. 4275669
		09.75 - 09.85	OM352A		3482 012 211	330 GMF330	Chass. 4275670->
		09.75 - 09.85			1861 571 236	330 10 330GSZ	Chass. 4275670->
		09.75 - 09.85			3151 044 031	KZI-3	Chass. 4275670->
	09.75 - 12.84			3482 012 211	330 GMF330	06.1977->	
	08.73 - 09.96			1861 571 236	330 10 330GSZ	06.1977->	
				3151 033 031	KZI-3	06.1977->	
1217 CA 615.245 615.244	05.82 - 10.90	OM366		3482 012 240	330 GMF330	615.244-245	
				1861 963 033	330 10 330WGSZ	615.244-245	
				3151 044 031	KZI-3	615.244-245	
1217 KO 381.066 381.065	09.75 - 09.85	OM353		3482 008 038	310 MF310	->Chass. 4275669	
				1861 303 248	310 10 310GSB	->Chass. 4275669	
				3151 044 031	KZI-3	->Chass. 4275669	
				3482 012 211	330 GMF330	Chass. 4275670->	
				1861 571 236	330 10 330GSZ	Chass. 4275670->	
				3151 044 031	KZI-3	Chass. 4275670->	
1217 KO 381.066 381.065	03.94 - 12.98	OM357.901, OM357.918		3482 012 211	330 GMF330		
				1861 571 236	330 10 330GSZ		
				3151 044 031	KZI-3		
1219							
1219 381.025 381.027/028 381.022/023 1219 K 381.046 1219 S 381.055 381.054	09.75 - 09.84	OM401		3482 011 331 #	360 GMF360		
					3482 000 953	350 GMF350X	
			09.75 - 09.84		1878 001 070	350 10 350GTZ	
		09.75 - 09.84		3151 043 031	KZI-4,5		
			OM401.906, OM401.905, OM401.914, OM401.915		1882 302 131	380 GF380	Sonderausführung / Special design (56)
					1878 000 105	380 10 380GTZ	Sonderausführung / Special design (56)
1219 A 381.122/123 1219 AK 381.146 1219 F 381.082 381.084 381.083	09.75 - 12.82	OM401		3482 011 331 #	360 GMF360		
					3482 000 953	350 GMF350X	
			09.75 - 12.84		1878 001 070	350 10 350GTZ	
			09.75 - 09.84		3151 043 031	KZI-4,5	

		CODE				
--	--	------	--	---	---	---





































MERCEDES-BENZ

1219									
1219 AF 381.183 381.182	09.75 - 09.84	OM401		3482 011 331 #	360 GMF360	381.182-183			
				3482 000 953	350 GMF350X	381.182-183			
				1878 001 070	350 10 350GTZ	381.182-183			
				3151 043 031	KZI-4,5	381.182-183			
				1882 288 131	380 GF380N	381.183 für Nebenantrieb / for PTO	(82)		
				1878 000 964	380 10 380GTZ	381.183 für Nebenantrieb / for PTO	(82)		
				3151 079 031	KZI-6	381.183 für Nebenantrieb / for PTO	(82)		
				OM401.919		1882 302 131	380 GF380	Sonderausführung / Special design	(56)
					1878 000 105	380 10 380GTZ	Sonderausführung / Special design	(56)	

1222									
1222 615.224 615.027/028 615.247 615.122 615.248 615.026	07.82 - 02.90	OM421/422		1882 302 131	380 GF380	->Chass. 5234953 615.122/224/226			
				1878 000 105	380 10 380GTZ	->Chass. 5234953 615.122/224/226			
				3151 000 375	KZIS-4	->Chass. 5095724 615.122/224/226			
				3151 126 031	KZI-4,5	Chass. 5095725-> 615.122/224/226			
				3482 124 541	430 GMF430	Chass. 5234954-> 615.122/224/226			
				1882 301 238 ●#	420 GF420	Chass. 5234954-> 615.122/224/226			
				1878 002 706	420 10 420GTZ	Chass. 5234954-> 615.122/224/226			
				OM421		1861 643 134 #	420 10 420GSZ	615.026-027/064 für Nebenantrieb / for PTO	(82)
					3151 079 031	KZI-6	615.026-027/064 für Nebenantrieb / for PTO	(82)	
1222 650.034 650.036/037 1222 A, 1222 LA 650.232 650.234 1222 AF 650.286 1222 F 650.086 1222 S, 1222 LS 650.132	07.89 - 08.94	OM441		3400 123 001	430 10 MFZ430	650.132/232/234/286/034/036-037/086			
	09.89 - 07.94			3482 081 232 1878 080 031 3151 000 549	430WGTZ KZISZ-5				
	09.89 - 09.93			1862 225 132 #	400 10 400GTZ				
	07.89 - 08.94								
1222 A 615.244 615.247 615.224 615.226 615.242 615.248 1222 S 615.122	05.82 - 10.90	OM421/422		1882 302 131	380 GF380	->Chass. 5234953 615.122/224/226			
	07.82 - 02.90			1878 000 105	380 10 380GTZ	->Chass. 5234953 615.122/224/226			
				3151 000 375	KZIS-4	->Chass. 5095724 615.122/224/226			
				3151 126 031	KZI-4,5	Chass. 5095725-> 615.122/224/226			
				3482 124 541	430 GMF430	Chass. 5234954-> 615.122/224/226			
				1882 301 238 ●#	420 GF420	Chass. 5234954-> 615.122/224/226			
				1878 002 706	420 10 420GTZ	Chass. 5234954-> 615.122/224/226			
1222 AF 615.264	05.82 - 12.91	OM421/422		1882 302 131	380 GF380				
				1878 000 105	380 10 380GTZ				
				3151 000 375	KZIS-4				









		CODE				
--	--	------	--	---	---	---

MERCEDES-BENZ



1222							
1222 AS 615.224 615.226 615.122 L 1222 615.027 615.026 615.028		OM421/422	 1882 302 131	380 GF380	->Chass. 5234953		
			 1878 000 105	380 10 380GTZ	->Chass. 5234953		
			 3151 000 375	KZIS-4	->Chass. 5095724		
			 3151 126 031	KZI-4,5	Chass. 5095725 - Chass. 5234953		
			 3482 124 541	430 GMF430	Chass. 5234954->		
			 1882 301 238 ●#	420 GF420	Chass. 5234954->		
			 1878 002 706	420 10 420GTZ	Chass. 5234954->		
			 3151 126 031	KZI-4,5	Chass. 5234954->		
1222 F 615.064	05.82 - 12.91	OM421/422	 1882 302 131	380 GF380	->Chass. 5234953 615.064		
			 1878 000 105	380 10 380GTZ	->Chass. 5234953 615.064		
			 3151 000 375	KZIS-4	->Chass. 5104252 615.064		
			 3151 126 031	KZI-4,5	Chass. 5104252 - Chass. 5234953 615.064		
			 3482 124 541	430 GMF430	Chass. 5234954-> 615.064		
			 1882 301 238 ●#	420 GF420	Chass. 5234954-> 615.064		
			 1878 002 706	420 10 420GTZ	Chass. 5234954-> 615.064		
			 3151 126 031	KZI-4,5	Chass. 5234954-> 615.064		
			OM421	 1861 643 134 #	420 10 420GSZ	615.026-027/064 für Nebenantrieb / for PTO (82)	
				 3151 079 031	KZI-6	615.026-027/064 für Nebenantrieb / for PTO (82)	
1224							
1224 650.288		OM366LA, 401LA	 3400 124 101	430 10 MFZ430			
			 3482 081 232	430WGTZ			
1224 AF 650.286 650.282	02.93 - 09.96	OM366LA, 401LA	 3482 051 132 #	350 GMF350X	->Chass. K062599		
			 1878 001 070	350 10 350GTZ	->Chass. K062599		
			 3151 000 374	KZIS-4	->Chass. K062599		
			 1882 166 737	380 GF380	Chass. K062600->		
			 1878 000 105	380 10 380GTZ	Chass. K062600->		
			 3151 000 374	KZIS-4	Chass. K062600->		
1224 AF 650.286 650.282	02.93 - 09.96	OM366LA, 401LA	 3400 123 001	430 10 MFZ430	650.286		
			 3482 081 232	430WGTZ			
1224 F 650.086	07.89 - 08.94	OM366LA, 401LA	 1878 080 031	KZISZ-5			
			 3151 000 549				
			 1862 225 132 #	400 10 400GTZ	650.286		
			 3400 123 001	430 10 MFZ430	650.086		
			 3482 081 232	430WGTZ			
			 1878 080 031	KZISZ-5			
			 3151 000 549				
			 1862 225 132 #	400 10 400GTZ	650.086		









		CODE				
--	--	------	--	---	---	---



MERCEDES-BENZ

1225						
1225 AF 615.264 615.266	05.82 - 12.91	OM421/422		1882 302 131	380 GF380	615.264
				1878 000 105	380 10 380GTZ	615.264
				3151 000 375	KZIS-4	615.264
		OM422		1882 302 135 #	380 GF380	615.266
				1878 000 105	380 10 380GTZ	615.266
				3151 126 031	KZI-4,5	615.266
1225 AF 615.266	05.82 - 12.91	OM422		1882 302 135 #	380 GF380	615.266
				1878 000 105	380 10 380GTZ	615.266
				3151 126 031	KZI-4,5	615.266

1226						
1226 AF 650.288	02.93 - 09.96	OM401.989, OM442.933, OM401.978, OM441.989, OM442.932, OM442.926, OM401.973, OM442.914, OM401.984, OM442.907, OM442.920		3400 124 101 ⊗ 3482 081 232 ⊗ 1878 005 668 ⊙ 3151 000 549	430 10 MFZ430 430WGTZ KZISZ-5	
	02.90 - 09.93					
	02.93 - 09.96					



























1227						
1227 A 650.234	01.92 - 07.92	OM401LA		3400 123 001 ⊗ 3482 081 232 ⊗ 1878 080 031 ⊙ 3151 000 549	430 10 MFZ430 430WGTZ KZISZ-5	
1227 AF, 1227 LAF 650.288 650.284	01.92 - 07.92	OM401LA		3400 124 101 ⊗ 3482 081 232 ⊗ 1878 005 668 ⊙ 3151 000 549	430 10 MFZ430 430WGTZ KZISZ-5	650.288
		OM441LA		3400 124 001 ⊗ 3482 081 231 ⊗ 1878 634 027 ⊙ 3151 000 278	430 10 MFZ430 430WGTZ KZISZ-5	650.284

1228						
1228 F 615.064		OM421/422		1882 302 131	380 GF380	->Chass. 5234953
				1878 000 105	380 10 380GTZ	->Chass. 5234953
				3151 000 375	KZIS-4	->Chass. 5104252
				3151 126 031	KZI-4,5	Chass. 5104253 - Chass. 5234953
				3482 124 541	430 GMF430	Chass. 5234954->
				1882 301 238 #	420 GF420	Chass. 5234954->
				1878 002 706	420 10 420GTZ	Chass. 5234954->
				3151 126 031	KZI-4,5	Chass. 5234954->

1231						
1231 AF 650.286	01.92 - 09.96	OM401LA		3400 123 001 ⊗ 3482 081 232 ⊗ 1878 080 031 ⊙ 3151 000 549	430 10 MFZ430 430WGTZ KZISZ-5	650.286
						

		CODE				
--	--	------	--	---	---	---











MERCEDES-BENZ

1234						
1234 AF 650.288 650.284	01.92 - 09.96	OM401LA		3400 124 101 ⊗ 3482 081 232 ⊗ 1878 005 668 ⊙ 3151 000 549	430 10 MFZ430 430WGTZ KZISZ-5	650.288
		OM441LA		3400 124 001 ⊗ 3482 081 231 ⊗ 1878 634 027 ⊙ 3151 000 278	430 10 MFZ430 430WGTZ KZISZ-5	
1313						
L,LA,LP 1313				1882 252 331	310 GFX310	Mot. 112293->
				1861 303 248	310 10 310GSB	Mot. 112293->
L,LA,LP 1313		OM352A		1882 252 333	310 GFX310	
				1861 303 248	310 10 310GSB	
L,LK,LS,LKO 1313 352.021-023 352.011 352.014 352.010 352.015 352.000-004		OM352, 353		1882 201 132	295 GF295	->Chass. 760271
				1861 279 133	295 10 295GTZ	->Chass. 760271
				3151 095 043	KZI-3	->Chass. 760271
				1882 252 331	310 GFX310	Chass. 760272 - Chass. 922885
				1861 303 248	310 10 310GSB	Chass. 760272->
				1882 305 131	310 GFX310	Chass. 922886->
				3151 095 043	KZI-3	
LA,LAK,LAS 1313 352.115 352.111 352.122 352.101-103 352.110 352.114 352.121		OM352, 353		1882 201 132	295 GF295	->Chass. 760271 352.101-103/110-111/114-115/121-122 nicht für Fahrgestellnummer / not for chassis no.: 500001-599999 (97)
				1861 279 133	295 10 295GTZ	->Chass. 760271 352.101-103/110-111/114-115/121-122 nicht für Fahrgestellnummer / not for chassis no.: 500001-599999 (97)
				1882 252 331	310 GFX310	Chass. 760272 - Chass. 922885 Chass. 500001 - Chass. 599999 352.101-103/110-111/114-115/121-122
				1861 303 248	310 10 310GSB	Chass. 760272-> Chass. 500001 - Chass. 599999 352.101-103/110-111/114-115/121-122
				1882 305 131	310 GFX310	Chass. 922886-> 352.101-103/110-111/114-115/121-122
				3151 095 043	KZI-3	352.101-103/110-111/114-115/121-122
LF 1313 352.018		OM352, 353		1882 252 333	310 GFX310	->Chass. 922885
				1882 305 132	310 GFX310	Chass. 922886->
				1861 303 248	310 10 310GSB	
				3151 095 043	KZI-3	
LP,LPK,LPKO 1313 352.050-054 352.063 352.062 352.072 352.071		OM352		1882 305 132	310 GFX310	Sonderausführung / Special design (56)
				1861 303 248	310 10 310GSB	Sonderausführung / Special design (56)
				3151 095 043	KZI-3	Sonderausführung / Special design (56)



















		CODE				
--	--	------	--	---	---	---

MERCEDES-BENZ

1313

LP,LPK,LPS 1313 352.072 352.062-065 352.071 352.050-054		OM352		1882 201 132	295 GF295	->Chass. 760271	
				1861 279 133	295 10 295GTZ	->Chass. 760271	
				3151 095 043	KZI-3	->Chass. 922885	
				1882 252 331	310 GFX310	Chass. 760272 - Chass. 922885	
				1861 303 248	310 10 310GSB	Chass. 760272->	
				1882 305 131	310 GFX310	Chass. 922886->	
				3151 095 043	KZI-3		
				1882 252 333	310 GFX310	->Chass. 922885 Sonderausführung / Special design	(56)
				1882 305 132	310 GFX310	Chass. 922886-> Sonderausführung / Special design	(56)
				1861 303 248	310 10 310GSB	Sonderausführung / Special design	(56)
				3151 095 043	KZI-3	Sonderausführung / Special design	(56)

1314







































1314 675.032 675.034 675.033 1314 AK 675.147 675.146 1314 K 675.046	07.84 - 12.98	OM366		3400 122 401  3482 008 038  1861 964 034  3151 044 031	310 10 MF310 310WGSZ KZI-3		
	06.87 - 12.98			3400 124 301  3482 012 211  1861 963 033  3151 044 031	330 10 GMF330 330WGSZ KZI-3	für / for: SA24493-01 Sonderausführung / Special design	(68) (56)
1314 KO 675.093	07.84 - 12.98	OM356.908, OM366.936		3400 124 301  3482 012 211  1861 963 033  3151 044 031	330 10 GMF330 330WGSZ KZI-3		
				3400 125 001  3482 000 953  1878 001 070  3151 000 374	350 10 GMF350X 350GTZ KZIS-4	für / for: SA33607-01	(68)
				3482 012 211	330 GMF330	für / for: SA24482-03	(68)
				1861 571 236	330 10 330GSZ	für / for: SA24482-03	(68)
				3151 116 031	KZI-3	für / for: SA24482-03	(68)







1317

1317 677.033		OM360Berlin		1882 234 433	350 GF350		
				1878 001 074	350 10 350GTZ		
		OM366A		3482 051 131 #	350 GMF350X	677.033	
				1878 001 070	350 10 350GTZ	677.033	
1317 675.095		OM366LA		3482 012 240	330 GMF330		
				1861 963 033	330 10 330WGSZ		
				3151 044 031	KZI-3		

		CODE				
--	--	------	--	---	---	---





























MERCEDES-BENZ









1317							
1317,1317 L 676.238.12 676.032 676.233 676.236 676.237.12 676.238 676.034-037 676.234 676.239 676.232 676.235 676.236.12 676.237 676.239.12 676.038 676.033 676.039 1317 S,1317 LS 676.056 676.257 676.256 676.059 676.057	01.84 - 12.98	OM356, 366, A, LA		3482 012 240	330 GMF330		
					1861 963 033	330 10 330WGSZ	
					3151 044 031	KZI-3	
		01.84 - 12.98	OM366		3482 051 131 #	350 GMF350X	Getr. / GBox: G4
					1878 001 144	350 10 350WGTZ	Getr. / GBox: G4
					3151 000 374	KZIS-4	Getr. / GBox: G4
1317,1317 L 676.337 676.339 677.033 676.438 676.436 676.439 676.336 676.338 676.437 1317 K 676.343 1317 KO 676.395 1317 LS 676.456/457	03.96 - 12.98	OM904LA		3400 121 401  3482 000 462  1878 052 842  3151 000 374	362 18 MF362 362WGTB KZIS-4	676.436-439/456-457/336-338/343/395	
	03.96 - 12.98			3400 700 484 HD 	362 10	676.436-439/456-457/336-338/343/395	
	03.96 - 12.98			 3482 000 462  1878 001 939	MF362 362WGTB		
	03.96 - 12.98						
1317 AK 675.147 675.146 1317 K 675.046	01.84 -	OM366		3400 122 401  3482 008 038  1861 964 034  3151 044 031	310 10 MF310 310WGSZ KZI-3		
	01.84 -						
1317 AK 676.147-149 676.146 675.146 1317 AK 676.147	08.84 - 12.98	OM366A, LA		3482 012 240	330 GMF330	676.146-149	
	12.92 - 12.98				1861 963 033	330 10 330WGSZ	676.146-149
					3151 044 031	KZI-3	676.146-149
1317 K 675.046 676.043	07.84 - 12.98	OM356, 366, LA		3482 012 240	330 GMF330	676.032-039/043	
					1861 963 033	330 10 330WGSZ	676.032-039/043
					3151 044 031	KZI-3	676.032-039/043
1317 KO 675.093		OM366		3400 124 301  3482 012 211  1861 963 033  3151 044 031	330 10 GMF330 330WGSZ KZI-3		
1317 KO 676.095 675.093	03.94 - 12.98	OM357.903, OM357.962, OM356.944		3400 124 301  3482 012 211  1861 963 033  3151 044 031	330 10 GMF330 330WGSZ KZI-3		
LP,LPK,LPS 1317 352				1882 234 433	350 GF350		
					1878 001 074	350 10 350GTZ	
					3151 094 041	KZI-4	
LP,LPK,LPS,LPKO 1317 352.082-087 352.055-059 352.091-093		OM327		1882 234 433	350 GF350		
					1878 001 074	350 10 350GTZ	
					3151 094 041	KZI-4	
LP,LPKO 1317 352				1878 001 074	350 10 350GTZ	Nebenantriebs-ID / PTO ID: 70,80 (48)	







1319						
LP,LPK,LPS,LPKO 1319 352.055-059 352.082-087 352.091-093		OM327		1882 234 433	350 GF350	
					1878 001 074	350 10 350GTZ
					3151 094 041	KZI-4
LP,LPKO 1319 352				1878 001 074	350 10 350GTZ	Nebenantriebs-ID / PTO ID: 70,80 (48)
LP,LPS 1319 327.				1882 234 433	350 GF350	
					1878 001 074	350 10

		CODE				
--	--	------	--	---	---	---

MERCEDES-BENZ





1320							
1320,1320 L 677.232 677.234 677.032 1320,1320 L 677.036 677.039 677.236 679.235 677.033 677.232/233 677.238 677.038 677.034 677.234 677.035 677.237 677.037 677.235 679.997 677.032 677.239	01.84 - 12.98	OM366, LA		3400 125 001  3482 000 953  1878 001 070  3151 000 374	350 10 GMF350X 350GTZ KZIS-4	677.032-039/232-234	
	01.84 - 12.98	OM366LA		1882 166 737  1878 000 105  3151 000 374	380 GF380 380 10 380GTZ	677.236-239/258-259 679.235	
					3482 012 240	330 GMF330	676.147
					1861 963 033	330 10 330WGSZ	676.147
1320 AK 676.147	12.92 - 12.98	OM366LA		3151 044 031	KZI-3	676.147	
	12.92 - 12.98	OM366LA		3400 125 001  3482 000 953  1878 001 070  3151 000 374	350 10 GMF350X 350GTZ KZIS-4	677.235	
				3400 125 001  3482 000 953  1878 001 070  3151 000 374	350 10 GMF350X 350GTZ KZIS-4	677.056-057	
1320 S,1320 LS 677.256 677.059 677.257-259 677.056/057	01.84 - 12.98	OM366, LA		3400 125 001  3482 000 953  1878 001 070  3151 000 374	350 10 GMF350X 350GTZ KZIS-4	677.056-057	
		OM366LA		3400 125 001  3482 000 953  1878 001 070  3151 000 374	350 10 GMF350X 350GTZ KZIS-4	677.256-257	
					1882 166 737	380 GF380	677.236-239/258-259 679.235
						1878 000 105	380 10 380GTZ
				3151 000 374	KZIS-4	677.236-239/258-259 679.235	





1324						
1324,1324 L 679.038 679.233 679.232 679.034 679.235/236 679.037 679.234 679.239 679.032 679.036 679.039 679.237 677.235 679.035 679.238 679.033	01.84 - 12.98	OM366LA, OM366LS		1882 166 737	380 GF380	
				1878 000 105	380 10 380GTZ	
				3151 000 374	KZIS-4	
1324 L 679.235	01.91 - 12.98	OM366LS		1882 166 737	380 GF380	679.235
				1878 000 105	380 10 380GTZ	679.235
				3151 000 374	KZIS-4	679.235
1324 S,1324 LS 679.259 679.056 679.257 679.058 679.258 679.057 679.059 679.256	01.84 - 12.98	OM366LA		1882 166 737	380 GF380	
				1878 000 105	380 10 380GTZ	
				3151 000 374	KZIS-4	



















1413						
1413 383.003 383.005 383.008 383.002 383.007	09.75 - 12.84	OM353		3482 008 038	310 MF310	
				1861 303 248	310 10 310GSB	
1413 A 383.103	09.75 - 12.84			3151 033 031	KZI-3	->Chass. 469330
1413 AK 383.140/141	09.75 - 12.84			3151 044 031	KZI-3	Chass. 469331->
1413 KO 383.060/061	09.75 - 12.84					
1413 AKO 383.160/161 1413 K 383.040/041	09.75 - 12.84	OM353		3482 008 038	310 MF310	
	09.75 - 12.84			1861 303 248	310 10 310GSB	
				3151 044 031	KZI-3	

		CODE		 Parameter		
--	--	------	--	---	---	---

MERCEDES-BENZ









1413						
L 1413				1882 230 238	280 HVB280	
				1861 919 134	280 10 280GTZ	
L,LA,LP 1413		OM352		1882 201 132	295 GF295	
				1861 279 133	295 10 295GTZ	
				3151 095 043	KZI-3	



1414						
1414 616.004 616.007 616.006 616.008	04.84 - 03.91	OM366		3400 122 401 ⊗ 3482 008 038 ⊗ 1861 964 034 ◊ 3151 044 031	310 10 MF310 310WGSZ KZI-3	
1414 K 616.105	04.84 - 03.91	OM366		3482 008 038	310 MF310	
				1861 303 248	310 10 310GSB	
				3151 116 031	KZI-3	











1417						
1417 651.012 651.014 651.017 651.016	07.89 - 09.96	OM356		3400 700 417 ⊗ 3482 000 953 ⊗ 1878 001 144 ◊ 3151 000 374	350 10 GMF350X 350WGTZ KZIS-4	651.012/014/016-017
1417 383.018 383.015 383.013 383.017	05.75 - 12.84	OM353		3482 008 038	310 MF310	->Chass. 4274598
1417 AKO 383.166 383.165	05.75 - 12.84			1861 303 248	310 10 310GSB	->Chass. 4274598
1417 KO 383.065/066	05.75 - 12.84			3151 044 031	KZI-3	->Chass. 4274598
				3482 012 211	330 GMF330	Chass. 4274599->
				1861 571 236	330 10 330GSZ	Chass. 4274599->
				3151 044 031	KZI-3	Chass. 4274599->
1417 A 651.212	09.89 - 09.96	OM356		3400 700 417 ⊗ 3482 000 953 ⊗ 1878 001 144 ◊ 3151 000 374	350 10 GMF350X 350WGTZ KZIS-4	651.012
1417 A 383.113	05.75 - 12.84	OM353		3482 008 038	310 MF310	->Chass. 4274598
1417 AK 383.143	05.75 - 12.84			1861 303 248	310 10 310GSB	->Chass. 4274598
1417 K 383.044 383.043	05.75 - 12.84			3151 044 031	KZI-3	->Chass. 4274598
				3482 012 211	330 GMF330	Chass. 4274599->
				1861 571 236	330 10 330GSZ	Chass. 4274599->
				3151 044 031	KZI-3	Chass. 4274599->
		OM352A		3482 012 211	330 GMF330	06.1977->
				1861 571 236	330 10 330GSZ	06.1977->
				3151 033 031	KZI-3	06.1977->
1417 AK 651.315 651.212	09.89 - 09.96	OM356		3400 700 417 ⊗ 3482 000 953 ⊗ 1878 001 144 ◊ 3151 000 374	350 10 GMF350X 350WGTZ KZIS-4	651.315

		CODE				
--	--	------	--	---	---	---

MERCEDES-BENZ

1417						
1417 C 616.016 616.014 616.018 616.017	04.84 - 03.91	OM366		3400 125 101 # ⊗ 3482 011 331 ⊗ 1878 001 070 ⊙ 3151 000 374	360 10 GMF360 350GTZ KZIS-4	
1417 CA 616.214	04.84 - 03.91			3482 051 131 ●#	350 GMF350X	Nur zusammen verbauen / Only install together (51)
1417 CAK 616.315	04.84 - 03.91			1878 001 144 ●	350 10 350WGTZ	Nur zusammen verbauen / Only install together (51)
1417 CK 616.115	04.84 - 03.91			3151 000 374	KZIS-4	
1417 K 651.115	07.89 - 09.96	OM356		3400 700 417 ⊗ 3482 000 953 ⊗ 1878 001 144 ⊙ 3151 000 374	350 10 GMF350X 350WGTZ KZIS-4	651.115
LP 1417	- 05.69	OM324		1878 001 074	350 10 350GTZ	
LP 1417	06.69 -	OM324		1882 234 433	350 GF350	
				1878 001 074	350 10 350GTZ	
				3151 044 031	KZI-3	





1418						
L,LS,LK,LP,LPS 1418 338.056 338.064 338.006 338.008 338.002 338.062 354.052 338.058 338.001 354.063 338.051 338.009 338.041 354.053 354.062 338.061 354.054/055 354.064 338.057 338.015 338.054 338.007		OM326, 346		1882 110 542	350 GF350	
				1878 001 074	350 10 350GTZ	

























1419						
1419,1419 L 383.222/223 383.022/023 383.025 383.228 383.027/028 383.225 383.227	08.73 - 09.96	OM401		3482 011 331 #	360 GMF360	383.022-028/222-228
				3482 000 953	350 GMF350X	383.022-028/222-228
				1878 001 070	350 10 350GTZ	383.022-028/222-228
				3151 043 031	KZI-4,5	383.022-028/222-228
1419 AK 383.146	05.75 - 12.84	OM401		3482 011 331 #	360 GMF360	
1419 AS 383.154	05.75 - 12.82			3482 000 953	350 GMF350X	
1419 F 383.084	05.75 - 12.82			1878 001 070	350 10 350GTZ	
1419 K 383.046/047	05.75 - 12.82			3151 043 031	KZI-4,5	
1419 S,1419 LS 383.054/055 383.254/255	08.73 - 09.96					
1419 C,1419 CL 616.448 616.046 616.048 616.447 616.047	08.73 - 09.96	OM362, 366		3400 125 101 # ⊗ 3482 011 331 ⊗ 1878 001 070 ⊙ 3151 000 374	360 10 GMF360 350GTZ KZIS-4	
				3482 051 131 ●#	350 GMF350X	Nur zusammen verbauen / Only install together (51)
				1878 001 144 ●	350 10 350WGTZ	Nur zusammen verbauen / Only install together (51)
				3151 000 374	KZIS-4	

1420						
1420,1420 L 651.427 651.014 651.024 651.026/027 651.426	12.87 - 09.96	OM366		3400 125 001 ⊗ 3482 000 953 ⊗ 1878 001 070 ⊙ 3151 000 374	350 10 GMF350X 350GTZ KZIS-4	651.426-427/522
1420 LS 651.522	02.90 - 09.96					

		CODE				
--	--	------	--	---	---	---













MERCEDES-BENZ















1420							
1420,1420 L 616.047 616.447 616.048 616.448 616.046	08.73 - 09.96	OM362, 366		3400 125 101 # ● 3482 011 331 ● 1878 001 070 ○ 3151 000 374	360 10 GMF360 350GTZ KZIS-4		
				3482 051 131 ●#	350 GMF350X	Nur zusammen verbauen / Only install together	(51)
				1878 001 144 ●	350 10 350WGTZ	Nur zusammen verbauen / Only install together	(51)
				3151 044 031	KZI-3		
1420 LS 616.542	07.85 - 03.91	OM366		3400 125 001 ● 3482 000 953 ● 1878 001 070 ○ 3151 000 374	350 10 GMF350X 350GTZ KZIS-4	616.542	

1422							
1422 651.032 651.036 651.034 651.037 1422 F 651.087 1422 F 651.087 1422 LS 651.532 651.531	02.93 - 08.94	OM401LA, 441, 441LA		3400 123 001 ● 3482 081 232 ● 1878 080 031 ○ 3151 000 549	430 10 MFZ430 430WGTZ KZISZ-5	651.434/436-437/531-532/032/034/036-037/087 /131-132	
	02.93 - 08.94			1862 225 132 #	400 10 400GTZ	651.434/436-437/531-532/032/034/036-037/087 /131-132	
	07.89 - 09.93						
	02.93 - 08.94						
1422,1422 L 651.436 651.434 651.437 651.032 651.037 651.034 651.036 1422 F 651.087 1422 S,1422 LS 651.131 651.531 651.132 651.532	12.87 - 09.96	OM401LA, 441, 441LA		3400 123 001 ● 3482 081 232 ● 1878 080 031 ○ 3151 000 549	430 10 MFZ430 430WGTZ KZISZ-5	651.434/436-437/531-532/032/034/036-037/087 /131-132	
	03.93 - 08.94			1862 225 132 #	400 10 400GTZ	651.434/436-437/531-532/032/034/036-037/087 /131-132	
	12.87 - 09.96		OM441		3400 123 001 ● 3482 081 232 ● 1878 080 031 ○ 3151 000 549	430 10 MFZ430 430WGTZ KZISZ-5	651.434/436-437/531-532
					1862 225 132 #	400 10 400GTZ	651.434/436-437/531-532
1422,1422 L 616.427 616.028 616.026 616.426 616.024 616.027 616.428 1422 F 616.065	08.73 - 09.96	OM421, 422		1882 302 131	380 GF380	->Chass. 5234953 616.024-028/426-428	
	05.82 - 10.90			1878 000 105	380 10 380GTZ	->Chass. 5095724 616.024-028/426-428	
				3151 000 375	KZIS-4	->Chass. 5095724 616.024-028/426-428	
				3151 126 031	KZI-4,5	Chass. 5095725 - Chass. 5234953 616.024-028/426-428	
				3482 124 541	430 GMF430	Chass. 5234954-> 616.024-028/426-428	
				1882 301 238 ●#	420 GF420	Chass. 5234954-> 616.024-028/426-428	
				1878 002 706	420 10 420GTZ	Chass. 5234954-> 616.024-028/426-428	
				3151 126 031	KZI-4,5	Chass. 5234954-> 616.024-028/426-428	
				1861 643 134 #	420 10 420GSZ	616.024-027/065 für Nebenantrieb / for PTO	(82)
				3151 079 031	KZI-6	616.024-027/065 für Nebenantrieb / for PTO	(82)
	1422 S, 1422 LS 616.522 616.122 616.121 616.521	08.73 - 09.96	OM421, 422		1882 302 131	380 GF380	->Chass. 5234953
				1878 000 105	380 10 380GTZ	->Chass. 5234953	
				3151 000 375	KZIS-4	->Chass. 5095724	
				3151 126 031	KZI-4,5	Chass. 5095725 - Chass. 5234953	
				3482 124 541	430 GMF430	Chass. 5234954->	
				1882 301 238 ●#	420 GF420	Chass. 5234954->	
				1878 002 706	420 10 420GTZ	Chass. 5234954->	
	3151 126 031	KZI-4,5	Chass. 5234954->				

		CODE				
--	--	------	--	---	---	---

MERCEDES-BENZ

1424						
1424,1424 L 651.446 651.044 651.447 651.444 651.046 651.042 651.047	12.87 - 09.96	OM401		3400 700 411 ⊗ 3482 081 232 ⊗ 1878 080 033 ⊙ 3151 000 278	430 10 MFZ430 430WGTZ KZISZ-5	651.447/537
1424 S,1424 LS 651.536/537 651.121/122 651.531/532	12.87 - 09.96	OM401LA, 441LA		3400 700 411 ⊗ 3482 081 232 ⊗ 1878 080 033 ⊙ 3151 000 278	430 10 MFZ430 430WGTZ KZISZ-5	651.042/044/046-047/121-122
1424,1424 L 651.047 651.436 651.444 651.042 651.046 651.447 651.446 651.044 651.427 651.437	12.87 - 09.96	OM401LA, 441LA		3400 700 411 ⊗ 3482 081 232 ⊗ 1878 080 033 ⊙ 3151 000 278	430 10 MFZ430 430WGTZ KZISZ-5	651.042/044/046-047/121-122
1424 S,1424 LS 651.121 651.536 651.122 651.537	12.87 - 09.96					
1424,1424 L 383.033 383.037/038 383.035	08.73 - 09.96	OM402		1882 302 131	380 GF380	383.057/085/256-257/033/035/037-038/048-049 /056
1424 F 383.085	07.75 - 01.87			1878 000 105	380 10 380GTZ	383.057/085/256-257/033/035/037-038/048-049 /056
1424 K 383.049 383.048	07.75 - 01.87			3151 000 375	KZIS-4	383.057/085/256-257/033/035/037-038/048-049 /056
1424 S,1424 LS 383.256/257 383.056/057	08.73 - 09.96					
1424 F 651.087		OM366LA, 401LA		3400 123 001 ⊗ 3482 081 232 ⊗ 1878 080 031 ⊙ 3151 000 549	430 10 MFZ430 430WGTZ KZISZ-5	
				1862 225 132 #	400 10 400GTZ	
LP 1424 354.012 354.052 354.013 354.062-064 354.055 354.002-006 354.015 354.053 354.016 354.054		OM346		1882 110 542	350 GF350	354.052-053-054-055/062-064
LPS 1424 354.002-006 354.015 354.052 354.055 354.062-064 354.012/013 354.053 354.016 354.054		OM355		1878 001 074	350 10 350GTZ	354.052-053-054-055/062-064
				1882 166 737	380 GF380	354.002-006/012-013/015-016
				1878 000 104	380 10 380GTZ	354.002-006/012-013/015-016
				3151 000 529	KZIS-4	354.002-006/012-013/015-016





1425						
1425 616.026-028		OM421, 422		1882 302 131	380 GF380	->Chass. 5234953
				1878 000 105	380 10 380GTZ	->Chass. 5234953
				3151 000 375	KZIS-4	->Chass. 5095724
				3151 126 031	KZI-4,5	Chass. 5095725 - Chass. 5234953
1425 AF 615.264	08.73 - 09.96	OM421/422		1882 302 131	380 GF380	615.264
				1878 000 105	380 10 380GTZ	615.264
				3151 000 375	KZIS-4	615.264
1425 F 615.065 616.065		OM421, 422		1882 302 131	380 GF380	->Chass. 5234953
1425 L 616.426-428				1878 000 105	380 10 380GTZ	->Chass. 5234953
				3151 000 375	KZIS-4	->Chass. 5104252
				3151 126 031	KZI-4,5	Chass. 5104253 - Chass. 5234953
				3482 124 541	430 GMF430	Chass. 5234954->
				1882 301 238 ●#	420 GF420	Chass. 5234954->
				1878 002 706	420 10 420GTZ	Chass. 5234954->
				3151 126 031	KZI-4,5	Chass. 5234954->















		CODE				
--	--	------	--	---	---	---

MERCEDES-BENZ

1425						
1425 S, 1425 LS 616.131/132 616.532	08.73 - 09.96	OM422.909		1882 302 135 #	380 GF380	
				1878 000 105	380 10 380GTZ	->Chass. 5104252
				3151 000 375	KZIS-4	->Chass. 5104252
				3151 126 031	KZI-4,5	Chass. 5104253->

1426						
1426 S, 1426 LS 651.542 651.142 651.141	12.87 - 09.96	OM366LA, 401, 442		3400 124 101 ● 3482 081 232 ● 1878 005 668 ● 3151 000 549	430 10 MFZ430 430WGTZ KZISZ-5	651.087/141-142/542



1427						
1427 651.047	02.93 - 09.96	OM401LA, 441LA		3400 700 411 ● 3482 081 232 ● 1878 080 033 ● 3151 000 278	430 10 MFZ430 430WGTZ KZISZ-5	651.047/089/121-122
1427 F 651.089	02.93 - 09.96					
1427 F 651.089	02.93 - 09.96	OM366LA, 401LA		3400 124 101 ● 3482 081 232 ● 1878 005 668 ● 3151 000 549	430 10 MFZ430 430WGTZ KZISZ-5	651.131/087
1427 S, 1427 LS 651.131 651.122 651.537	02.93 - 09.96	OM366LA, 401LA		3400 124 101 ● 3482 081 232 ● 1878 005 668 ● 3151 000 549	430 10 MFZ430 430WGTZ KZISZ-5	651.131
		OM401LA, 441LA		3400 700 411 ● 3482 081 232 ● 1878 080 033 ● 3151 000 278	430 10 MFZ430 430WGTZ KZISZ-5	651.047/089/121-122















1428						
1428 AF 615.264		OM421, 422		1882 302 131	380 GF380	615.264
				1878 000 105	380 10 380GTZ	615.264
				3151 000 375	KZIS-4	615.264
1428 AF 615.264 615.266	08.73 - 09.96	OM422		1882 302 135 #	380 GF380	615.266
				1878 000 105	380 10 380GTZ	615.266
				3151 126 031	KZI-4,5	615.266
1428 F 615.065		OM421, 422		1882 302 131	380 GF380	->Chass. 5234953
				1878 000 105	380 10 380GTZ	->Chass. 5234953
				3151 000 375	KZIS-4	->Chass. 5104252
				3151 126 031	KZI-4,5	Chass. 5104253 - Chass. 5234953
				3482 124 541	430 GMF430	Chass. 5234954->
				1882 301 238 ●#	420 GF420	Chass. 5234954->
				1878 002 706	420 10 420GTZ	Chass. 5234954->
	3151 126 031	KZI-4,5	Chass. 5234954->			

1429						
1429 AF 650.288	01.92 - 09.96	OM442		3400 124 101 ● 3482 081 232 ● 1878 005 668 ● 3151 000 549	430 10 MFZ430 430WGTZ KZISZ-5	650.288





		CODE				
--	--	------	--	---	---	---

MERCEDES-BENZ

1431						
1431 651.034	12.87 - 08.96	OM401.979, OM442.907		3400 124 101 ⊗ 3482 081 232 ⊗ 1878 005 668 ⊙ 3151 000 549	430 10 MFZ430 430WGTZ KZISZ-5	651.034/087
1431 651.034	12.87 - 08.96					
1431 F 651.087	12.87 - 08.96					
1431 S 651.121		OM401LA, 441LA		3400 700 411 ⊗ 3482 081 232 ⊗ 1878 080 033 ⊙ 3151 000 278	430 10 MFZ430 430WGTZ KZISZ-5	







1513						
L,LA,LB,LP 1513 LPS,LPK 1513		OM352		1882 252 331	310 GFX310	
				1861 303 248	310 10 310GSB	
L,LA,LK,LS 1513 360.101 360.003 360.102 360.002 360.010-015 LAK,LKO,LAKO 1513 360.121/122 360.021-023 360.110-113		OM352, 353		1882 305 131	310 GFX310	
				1861 303 248	310 10 310GSB	
				1861 303 248 ●	310 10 310GSB	
				3151 095 043	KZI-3	
LP,LPK,LPS 1513 360.050-054 360.071-073 360.062-065		OM352, 353		1882 252 331	310 GFX310	->Chass. 922885
				1882 305 131	310 GFX310	Chass. 922886->
				1861 303 248	310 10 310GSB	
				3151 095 043	KZI-3	
				1882 252 333	310 GFX310	->Chass. 922885 Sonderausführung / Special design (56)
				1861 303 248	310 10 310GSB	->Chass. 922885 Sonderausführung / Special design (56)
				3151 095 043	KZI-3	->Chass. 922885 Sonderausführung / Special design (56)
				1882 305 132	310 GFX310	Chass. 922886-> Sonderausführung / Special design (56)
				1861 303 248	310 10 310GSB	Chass. 922886-> Sonderausführung / Special design (56)
				3151 095 043	KZI-3	Chass. 922886-> Sonderausführung / Special design (56)



1514						
1514,1514 L 675.224 675.022 675.025 675.222 675.023 675.223 675.024 675.225	01.84 - 12.98	OM366		3400 122 401 ⊗ 3482 008 038 ⊗ 1861 964 034 ⊙ 3151 044 031	310 10 MF310 310WGSZ KZI-3	675.022-025/045/222-225
1514 K 675.045	01.89 - 12.98					





1517						
1517,1517 L 676.045 676.226 676.225 676.228 676.024 676.026/027 676.023 676.223 676.222 676.224 676.227 676.229 676.028/029 676.025 676.022	01.84 - 12.98	OM366, A, LA		3482 012 240	330 GMF330	676.022-029/222-229
				1861 963 033	330 10 330WGSZ	676.022-029/222-229
				3151 044 031	KZI-3	676.022-029/222-229
1517,1517 L 676.328 676.429 676.329 676.427 676.326 676.426 676.428 676.327	03.96 - 12.98	OM904LA		3400 121 401 ⊗ 3482 000 462 ⊗ 1878 052 842 ⊙ 3151 000 374	362 18 MF362 362WGTB KZIS-4	676.326-329/349/426-429
1517 K 676.349	03.96 - 12.98			1878 001 939 HD●	362 18 362WGTB	676.326-329/349/426-429







		CODE				
--	--	------	--	---	---	---





MERCEDES-BENZ

1517						
1517 K 676.049 676.045	01.89 - 12.98	OM366LA	 3482 051 131 #	350 GMF350X	676.045/049	
			 1878 001 144	350 10 350WGTZ	676.045/049	
			 3151 000 374	KZIS-4	676.045/049	
L,LA,LK,LP,LS 1517 360.132-134 360.032-034 360.106/107 360.006-008 360.055-059 360.082-085 360.091-093 LAK,LAS,LPK,LPS 1517 360.032-034 360.091-093 360.082-085 360.055-059 360.006-008 360.106/107 360.132-134		OM327, 360	 1882 234 433	350 GF350	360.082-085/091-093/106-107/006-008/032-034 /055-059/132-134	
			 1878 001 074	350 10 350GTZ	360.082-085/091-093/106-107/006-008/032-034 /055-059/132-134	
			 3151 094 041	KZI-4	360.082-085/091-093/106-107/006-008/032-034 /055-059/132-134	
LP 1517 360 LPKO 1517 360			 1878 001 074	350 10 350GTZ	Nebenantriebs-ID / PTO ID: 70,80	(48)

1518						
LA 1518 339 LAK 1518 339			 1882 110 542	350 GF350		
			 1861 034 147 #	350 10 350		
LP 1518			 1882 110 542	350 GF350		
			 1878 001 074	350 10 350GTZ		















1519						
L,LA,LK,LP,LS 1519 360.106 360.006-008 360.082-085 360.132-107 360.091-093 360.032-034 360.055-059 LAK,LAS,LPK,LPS 1519 360.082-085 360.055-059 360.006-008 360.091-093 360.132-134 360.032-034 360.107 360.106		OM327, 360	 1882 234 433	350 GF350	360.082-085/091-093/106-107/006-008/032-034 /055-059/132-134	
			 1878 001 074	350 10 350GTZ	360.082-085/091-093/106-107/006-008/032-034 /055-059/132-134	
			 3151 094 041	KZI-4	360.082-085/091-093/106-107/006-008/032-034 /055-059/132-134	
LP 1519 360 LPKO 1519 360			 1878 001 074	350 10 350GTZ	Nebenantriebs-ID / PTO ID: 70,80	(48)







1520						
1520,1520 L 677.026 677.029 677.223/224 677.022 677.028 677.225 677.222 677.226 677.228 677.024 677.023 677.229 677.227 677.027 677.025	01.84 - 12.98	OM366LA	 3482 051 131 #	350 GMF350X	677.022-029/222-225	
			 1878 001 070	350 10 350GTZ	677.022-029/222-225	
			 3151 000 374	KZIS-4	677.022-029/222-225	
			 1882 166 737	380 GF380	677.226-229	
			 1878 000 105	380 10 380GTZ	677.226-229	
			 3151 000 374	KZIS-4	677.226-229	













1524						
1524,1524 L 677.024 679.025 679.027/028 679.225 679.228 679.029 679.223 679.226/227 679.026 679.222 679.229 679.022-024 679.224	01.84 - 12.98	OM366LA	 1882 166 737	380 GF380	677.024 679.022-029/222-229	
			 1878 000 105	380 10 380GTZ	677.024 679.022-029/222-229	
			 3151 000 374	KZIS-4	677.024	
			 3151 000 374	KZIS-4	679.022-029/222-229	

		CODE				
--	--	------	--	---	---	---

MERCEDES-BENZ



































1613						
1613,1613 L 385.004 385.008/009 385.204 385.208 385.007 385.000 385.207 385.209 385.006	08.73 - 09.96	OM353	 3482 008 038	310 MF310		
			 1861 303 248	310 10 310GSB		
			 3151 033 031	KZI-3	->Chass. 4696330	
			 3151 044 031	KZI-3	Chass. 4696331->	
1613 K 385.040-042	01.75 - 12.84	OM353	 3482 008 038	310 MF310	385.040-041-042	
			 1861 303 248	310 10 310GSB	385.040-041-042	
			 3151 033 031	KZI-3	->Chass. 4188089 385.040	
			 3151 044 031	KZI-3	Chass. 4188090-> 385.040	
			 3151 033 031	KZI-3	->Chass. 4696330 385.041	
			 3151 044 031	KZI-3	Chass. 4696331-> 385.041	
			 3151 044 031	KZI-3	385.042	
1613 KO 385.063 385.062	01.75 - 12.84	OM353	 3482 008 038	310 MF310	385.062-063	
			 1861 303 248	310 10 310GSB	385.062-063	
			 3151 033 031	KZI-3	->Chass. 4188089 385.062-063	
			 3151 044 031	KZI-3	Chass. 4188090-> 385.062-063	

1614						
1614 617.003 617.006 617.008 617.004	04.84 - 03.91	OM366	 3400 122 401	310 10 MF310		
1614 K 617.106/107	04.84 - 03.91	OM366	 3482 008 038	310 10 310WGSZ		
			 1861 964 034	KZI-3	617.106-107	
			 3151 044 031			
1614 K 617.106/107	04.84 - 03.91	OM366	 3482 008 038	310 MF310	617.106-107	
			 1861 303 248	310 10 310GSB	617.106-107	
			 3151 116 031	KZI-3	617.106-107	

1617						
1617,1617 L 385.010 385.218 385.014 385.019 385.214 385.219 385.016-018 385.217	08.73 - 09.96	OM353	 3482 008 038	310 MF310	->Chass. 4188089 385.010/014/016-019	
			 1861 303 248	310 10 310GSB	->Chass. 4188089 385.010/014/016-019	
			 3151 033 031	KZI-3	->Chass. 4188089 385.010/014/016-019	
			 3482 012 211	330 GMF330	Chass. 4188090-> 385.010/014/016-019	
			 1861 571 236	330 10 330GSZ	Chass. 4188090-> 385.010/014/016-019	
			 3151 044 031	KZI-3	Chass. 4188090-> 385.010/014/016-019	
			 3482 012 211	330 GMF330	385.214/217-219	
			 1861 571 236	330 10 330GSZ	385.214/217-219	
			 3151 044 031	KZI-3	385.214/217-219	
			1617 A,AKO,K,KO		OM353	 3482 008 038
 1861 303 248	310 10 310GSB					
 3151 044 031	KZI-3					

		CODE				
--	--	------	--	---	---	---





MERCEDES-BENZ























1617						
1617 AK 385.143/144	01.75 - 07.85	OM353	 3482 008 038	310 MF310	->Chass. 4276220	
			 1861 303 248	310 10 310GSB	->Chass. 4276220	
			 3151 033 031	KZI-3	->Chass. 4276220	
			 3482 012 211	330 GMF330	Chass. 4276221->	
			 1861 571 236	330 10 330GSZ	Chass. 4276221->	
			 3151 044 031	KZI-3	Chass. 4276221->	
		OM352A	 3482 012 211	330 GMF330	06.1977->	
			 1861 571 236	330 10 330GSZ	06.1977->	
 3151 033 031	KZI-3		06.1977->			
1617 C,1617 CL 617.016 617.019 617.014 617.414 617.416 617.418 617.018 617.013 1617 CAK 617.316 1617 CK 617.117 617.116 1617 CS 617.111	08.73 - 09.96	OM362, 366	 3400 125 101 #	360 10 GMF360 350GTZ KZIS-4		
	04.84 - 03.91		 3482 051 131 ●#	350 GMF350X	Nur zusammen verbauen / Only install together (51)	
	04.84 - 03.91		 1878 001 144 ●	350 10 350WGTZ	Nur zusammen verbauen / Only install together (51)	
	04.84 - 03.91		 3151 000 374	KZIS-4		
1617 K 385.044 385.043 385.045	01.75 - 07.85	OM353	 3482 008 038	310 MF310	->Chass. 4188089 385.043-045	
			 1861 303 248	310 10 310GSB	->Chass. 4188089 385.043-045	
			 3151 033 031	KZI-3	->Chass. 4188089 385.043-045	
			 3482 012 211	330 GMF330	Chass. 4188090-> 385.043-045	
			 1861 571 236	330 10 330GSZ	Chass. 4188090-> 385.043-045	
			 3151 044 031	KZI-3	Chass. 4188090-> 385.043-045	
		OM352A	 3482 012 211	330 GMF330	06.1977->	
			 1861 571 236	330 10 330GSZ	06.1977->	
			 3151 033 031	KZI-3	06.1977->	
			 3482 008 038	310 MF310	->Chass. 4188089 385.067-069	
1617 KO 385.069 385.067/068	01.75 - 07.85	OM353	 1861 303 248	310 10 310GSB	->Chass. 4188089 385.067-069	
			 3151 033 031	KZI-3	->Chass. 4188089 385.067-069	
			 3482 012 211	330 GMF330	Chass. 4188090-> 385.067/069	
			 1861 571 236	330 10 330GSZ	Chass. 4188090-> 385.067/069	
			 3151 044 031	KZI-3	Chass. 4188090-> 385.067/069	
			 3482 008 038	310 MF310	->Chass. 4188089 385.052	
1617 S 385.052	01.75 - 07.85	OM353	 1861 303 248	310 10 310GSB	->Chass. 4188089 385.052	
			 3151 033 031	KZI-3	->Chass. 4188089 385.052	
			 3482 012 211	330 GMF330	Chass. 4188090-> 385.052	
			 1861 571 236	330 10 330GSZ	Chass. 4188090-> 385.052	
			 3151 044 031	KZI-3	Chass. 4188090-> 385.052	
			 3482 008 038	310 MF310	->Chass. 4188089 385.052	

		CODE				
--	--	------	--	---	---	---

MERCEDES-BENZ































1617						
LP,LPKO 1617 355.059 355.058 355.092 355.056/057 355.093 355.055		OM360		1882 234 433	350 GF350	
				1878 001 074	350 10 350GTZ	
				3151 094 041	KZI-4	
LP 1617 355				1878 001 074	350 10 350GTZ	Nebenantriebs-ID / PTO ID: 70,80 (48)

1618						
1618 349				1882 166 737	380 GF380	
				1878 000 104	380 10 380GTZ	
L 1618 349				1882 110 542	350 GF350	
				1861 034 147 #	350 10 350	
LK 1618 349						
LS 1618 349						

1619						
1619 370				1882 166 737	380 GF380	
				1878 000 104	380 10 380GTZ	
1619,1619 L 385.027 385.228 385.026 385.028/029 385.224 385.227 385.024 385.020 385.229 1619 K 385.046 385.048 385.047 1619 KO 385.071 385.070 385.072	08.73 - 09.96	OM401		3482 051 131 #	350 GMF350X	385.054-055/070-072/122/146-147/224/227-229 /020/024/026-029/046-048
	11.74 - 12.82			1878 001 070	350 10 350GTZ	385.054-055/070-072/122/146-147/224/227-229 /020/024/026-029/046-048
				3151 043 031	KZI-4,5	/020/024/026-029/046-048 385.054-055/070-072/122/146-147/224/227-229 /046-048
	11.74 - 01.87			1882 302 131	380 GF380	385.054-055/070-072/227/020/024/026-029 /046-048
				1878 000 105	380 10 380GTZ	385.054-055/070-072/227/020/024/026-029 /046-048
				3151 000 375	KZIS-4	385.054-055/070-072/227/020/024/026-029 /046-048
				OM401.905, OM401.914		1882 288 131
				1878 000 964	380 10 380GTZ	385.070-072/146-147/020/024/026-028/046-048 für Nebenantrieb / for PTO (82)
1619 AK 385.146/147	11.74 - 12.82	OM401		3482 051 131 #	350 GMF350X	385.146-147
				1882 288 131	380 GF380N	385.146-147 für Nebenantrieb / for PTO (82)
				1878 001 070	350 10 350GTZ	385.146-147
				1878 000 964	380 10 380GTZ	385.146-147 für Nebenantrieb / for PTO (82)
				3151 043 031	KZI-4,5	385.146-147
1619 C,1619 CL 617.447 617.044 617.043 617.049 617.448	08.73 - 09.96	OM362, 366		3400 125 101 #	360 10 GMF360	617.043-049/447-448
				3482 011 331	350GTZ	
				1878 001 070	KZIS-4	
				3151 000 374		
				3482 051 131 ●#	350 GMF350X	617.043-049/447-448 Nur zusammen verbauen / Only install together (51)
	1878 001 144 ●	350 10 350WGTZ	617.043-049/447-448 Nur zusammen verbauen / Only install together (51)			
	3151 000 374	KZIS-4	617.043-049/447-448			

		CODE				
--	--	------	--	---	---	---







MERCEDES-BENZ











1619						
1619 S 385.055 385.054	11.74 - 12.84	OM401	 3482 051 131 #	350 GMF350X	385.054-055	
			 1878 001 070	350 10 350GTZ	385.054-055	
			 3151 043 031	KZI-4,5	385.054-055	
			 1882 302 131	380 GF380	385.054-055	
			 1878 000 105	380 10 380GTZ	385.054-055	
			 3151 000 375	KZIS-4	385.054-055	
LP 1619 355.093 355.092 355.055-059 LPKO 1619 355.092 355.055-093		OM360	 1882 234 433	350 GF350		
			 1878 001 074	350 10 350GTZ		
			 3151 094 041	KZI-4		
LP 1619 355			 1878 001 074	350 10 350GTZ	Nebenantriebs-ID / PTO ID: 70,80	(48)
1620						
1620,1620 L 617.044 617.047/048 617.046 617.447/448 617.043 617.049	08.73 - 09.96	OM362, 366	 3400 125 101 #  3482 011 331  1878 001 070  3151 000 374	360 10 GMF360 350GTZ KZIS-4	617.043-049/447/448	
			 3482 051 131 ●#	350 GMF350X	617.043-049/447/448 Nur zusammen verbauen / Only install together	(51)
			 1878 001 144 ●	350 10 350WGTZ	617.043-049/447/448 Nur zusammen verbauen / Only install together	(51)
			 3151 000 374	KZIS-4	617.043-049/447/448	
L 1620 LK 1620 LPS 1620 LS 1620	09.65 - 09.65 - 09.65 - 09.65 -		 1882 166 737	380 GF380	Getr. / GBox: AK 6-80	
			 1878 000 104	380 10 380GTZ	Getr. / GBox: AK 6-80	
			 3151 000 529	KZIS-4	Getr. / GBox: AK 6-80	
L 1620 LP 1620	-08.65 -08.65		 1882 166 737	380 GF380	Getr. / GBox: AK 6-7	
			 1863 010 100	GR-4	Getr. / GBox: AK 6-7 mit Anlauftring / with thrust ring	(88)
1621						
1621 349			 1882 110 542	350 GF350		
			 1861 034 147 #	350 10 350		
			 1882 166 737	380 GF380		
			 1878 000 104	380 10 380GTZ		
			 3151 000 529	KZIS-4		
L 1621 LK 1621 LS 1621		OM355	 1882 166 737	380 GF380		
			 1878 000 104	380 10 380GTZ		
			 3151 000 529	KZIS-4		

		CODE				
--	--	------	--	---	---	---

MERCEDES-BENZ

























1622							
1622,1622 L 617.026 617.426/427 617.027 617.025 617.028 617.023 617.425 617.029 617.024 617.424 617.428	08.73 - 09.96	OM421		1882 302 131	380 GF380	->Chass. 234953 617.424-428/023-029	
				1878 000 105	380 10 380GTZ	->Chass. 234953 617.023-029/424-428	
				3151 000 375	KZIS-4	->Chass. 234953 617.023-029/424-428	
				3482 124 541	430 GMF430	Chass. 234954-> 617.023-029/424-428	
				1882 301 238 ●#	420 GF420	Chass. 234954-> 617.023-029/424-428	
				1878 002 706	420 10 420GTZ	Chass. 234954-> 617.424-428/023-029	
				3151 000 375	KZIS-4	Chass. 234954-> 617.424-428/023-029	
				1861 643 134 #	420 10 420GSZ	617.023-029 für Nebenantrieb / for PTO	(82)
				3151 079 031	KZI-6	617.023-029 für Nebenantrieb / for PTO	(82)
1622 AK 617.326 1622 K 617.127 617.126 1622 S 617.122 617.121	05.82 - 10.89	OM421		1882 302 131	380 GF380	->Chass. 234953	
	05.82 - 10.89			1878 000 105	380 10 380GTZ	->Chass. 234953	
	05.82 - 03.91			3151 000 375	KZIS-4	->Chass. 234953	
				3482 124 541	430 GMF430	Chass. 234954->	
				1882 301 238 ●#	420 GF420	Chass. 234954->	
				1878 002 706	420 10 420GTZ	Chass. 234954->	
				3151 000 375	KZIS-4	Chass. 234954->	
				1861 643 134 #	420 10 420GSZ	für Nebenantrieb / for PTO	(82)
				3151 079 031	KZI-6	für Nebenantrieb / for PTO	(82)

1623						
1623 K,L,S,AK,AS,LS 387.027 387.122 387.227 387.026 387.053 387.222-224 387.226 387.022-024 387.154 387.054		OM403		1800 125 301	420 10 GF420	387.154/222-224/226-227/022-024/026-027/053/054/122
				1882 301 239	420GTZ	387.154/222-224/226-227/022-024/026-027/053/054/122
L 1623 LA 1623 LP 1623				1878 002 706	KZIS-4	
				3482 124 534 ●	430 GMF430	
				1882 166 737	380 GF380	
				1878 000 104	380 10 380GTZ	

1624						
1624 335, 346				1882 166 737	380 GF380	
				1878 000 104	380 10 380GTZ	
				3151 000 529	KZIS-4	
1624,1624 L 385.237 385.239 385.034 385.039 385.030 385.036 385.038 385.037 385.238	08.73 - 09.96	OM402		1882 302 131	380 GF380	385.030/034/036-039/237-239
				1878 000 105	380 10 380GTZ	385.030/034/036-039/237-239
				3151 000 375	KZIS-4	385.030/034/036-039/237-239
				1861 643 134 #	420 10 420GSZ	Chass. 4372224-> 385.034/036 für Nebenantrieb / for PTO
1624 K 385.090 385.049 1624 S,1624 LS 385.056 385.256 385.057	07.75 - 08.82	OM402		1882 302 131	380 GF380	385.049/056-057/256
	08.73 - 09.96			1878 000 105	380 10 380GTZ	385.049/056-057/256
				3151 000 375	KZIS-4	385.049/056-057/256







		CODE				
--	--	------	--	---	---	---









MERCEDES-BENZ



1624							
L 1624 335.365 335.364 335.352 335.362 335.354-356 LA 1624 335.364/365 335.362 335.352 335.354-356 LAK 1624 346.302-304 349.305 346.104 346.333 346.103 LAS 1624 349.305 346.302-304 346.104 346.103 346.333 LK 1624 349.305 346.333 346.103/104 346.302-304 LP 1624 335.362 335.365 335.364 335.352 335.354-356 LPK 1624 335.362 335.352 335.354-356 335.365 335.364 LPS 1624 335.365 335.364 335.362 335.354-356 335.352 LS 1624 349.305 346.104 346.103 346.302-304 346.333	OM355		1882 166 737	380 GF380			
			1878 000 104	380 10 380GTZ			
			3151 000 529	KZIS-4			
LA 1624 346.103			1882 288 131	380 GF380N	Nebenantriebs-ID / PTO ID: 80,90	(48)	
LAK 1624 346.103			1882 288 131	380 GF380N	für Nebenantrieb / for PTO	(82)	
1625							
1625,1625 L 617.033-035 617.437 617.036 617.436 617.435	08.73 - 09.96	OM422		1882 302 135 #	380 GF380	617.033-034-035-036	
				1878 000 105	380 10 380GTZ	617.033-034-035-036	
				3151 000 375	KZIS-4	-> Chass. 5107148 617.033-034-035-036	
				3151 126 031	KZI-4,5	Chass. 5107149-> 617.033-034-035-036	
				1882 302 135 #	380 GF380	617.435-436-437	
				1878 000 105	380 10 380GTZ	617.435-436-437	
				3151 000 375	KZIS-4	617.435-436	
				3151 126 031	KZI-4,5	617.437	
				1800 125 301  1882 301 239  1878 002 706  3151 000 375	420 10 GF420 420GTZ KZIS-4	617.435/436/437 Sonderausführung / Special design	(56)
				1878 000 964	380 10 380GTZ	617.036 für Nebenantrieb / for PTO	(82)
	3151 204 001	KZI-6	617.036 für Nebenantrieb / for PTO mit Schmierrohranschluß / with lubricating pipe coupling	(82) (91)			
1625 AK 617.336	10.80 - 11.89	OM422		1882 302 135 #	380 GF380	617.336	
				1878 000 105	380 10 380GTZ	617.336	
				3151 126 031	KZI-4,5	617.336	
1625 K 617.136	05.80 - 11.89	OM422		1882 302 135 #	380 GF380	617.136	
				1878 000 105	380 10 380GTZ	617.136	
				3151 000 375	KZIS-4	617.136	











		CODE				
--	--	------	--	---	---	---

MERCEDES-BENZ

1625						
1625 S,1625 LS 617.531/532 617.130-132	08.73 - 09.96	OM422		1882 302 135 #	380 GF380	617.532
				1878 000 105	380 10 380GTZ	617.532
				3151 000 375	KZIS-4	617.532
				1882 302 135 #	380 GF380	617.130-131-132
				1878 000 105	380 10 380GTZ	617.130-131-132
				3151 000 375	KZIS-4	->Chass. 5107148 617.130-131-132
				3151 126 031	KZI-4,5	Chass. 5107149-> 617.130-131-132











































1626						
1626,1626 L 387.217/218 387.017 387.216 387.294 387.018 387.016 1626 AS 387.112 387.114 1626 S,1626 LS 387.011 387.013 387.212 387.012 387.214 387.213 387.014	08.73 - 09.96	OM402		1882 302 131	380 GF380	387.011-014/016-018/112/114/212-214/216-218 /294
	05.74 - 12.80			1878 000 105	380 10 380GTZ	387.011-014/016-018/112/114/212-214/216-218 /294
	08.73 - 09.96			3151 000 375	KZIS-4	387.011-014/016-018/112/114/212-214/216-218 /294
1626 AK 387.144 1626 K 387.043/044	08.73 - 12.80	OM402		1882 302 131	380 GF380	387.144/043-044
	08.73 - 12.80			1878 000 105	380 10 380GTZ	387.144/043-044
				3151 000 375	KZIS-4	387.144/043-044
				1861 643 134 #	420 10 420GSZ	Chass. 4372224-> 387.043-044/144 für Nebenantrieb / for PTO
LP 1626 363.011-013 363.001-004 LPK 1626 363.011-013 363.001-004 LPS 1626 363.001-004 363.011-013		OM402		1882 166 737	380 GF380	
				1878 000 104	380 10 380GTZ	

1627						
1627 AF 650.288	01.92 - 09.96	OM401LA		3400 124 101  3482 081 232  1878 005 668  3151 000 549	430 10 MFZ430 430WGTZ KZISZ-5	650.288

1628						
1628,1628 L 617.033 620.417 617.336 620.016 620.415/416 620.066 620.466 617.034 620.015	08.73 - 09.96	OM422		1882 302 135 #	380 GF380	617.437
				1878 000 105	380 10 380GTZ	617.437
				3151 126 031	KZI-4,5	617.437
				1800 125 301  1882 301 239  1878 002 706  3151 000 375	420 10 GF420 420GTZ KZIS-4	620.015/016/020/066/415-417/466
				3482 124 534 ●	430 GMF430	620.015/016/020/066/415-417/466
				1882 342 134	420 GF420X	620.066/416/466 Sonderausführung / Special design
			1878 002 878	420 10 420GTZ	620.066/416/466 Sonderausführung / Special design	(56)
			3151 110 031	KZI-4,5	620.066/416/466 Sonderausführung / Special design	(56)



		CODE				
--	--	------	--	---	---	---











MERCEDES-BENZ













1628							
1628 A 621.219	01.80-05.89	OM422	 1800 125 301  1882 301 239  1878 002 706  3151 000 375	420 10 GF420 420GTZ KZIS-4			
			 3482 124 534 ●	430 GMF430			
			 1882 304 237	420 GF420N	für Nebenantrieb / for PTO	(82)	
			 1878 634 014	420 10 420GSZ	für Nebenantrieb / for PTO	(82)	
1628 S,1628 LS 620.111 620.162 620.563 620.511 620.110 620.163 620.513 620.512 620.112/113 620.562	08.73-09.96	OM422	 1800 125 301  1882 301 239  1878 002 706  3151 000 375	420 10 GF420 420GTZ KZIS-4			
			 3482 124 534 ●	430 GMF430			
1632							
1632,1632 L 387.226 387.026 387.227 387.027 1632 AS 387.122	08.73-09.96	OM403	 1800 125 301  1882 301 239  1878 002 706  3151 000 375	420 10 GF420 420GTZ KZIS-4	387.122/026-027/226/227		
		05.74-09.83		 3482 124 534 ●	430 GMF430	387.122/026-027/226/227	
1632 AK 387.154 1632 K 387.053/054	08.73-08.82	OM403	 1800 125 301  1882 301 239  1878 002 706  3151 000 375	420 10 GF420 420GTZ KZIS-4	387.053-054/154		
		08.73-08.82		 3482 124 534 ●	430 GMF430	387.053-054/154	
				 1882 304 237	420 GF420N	387.053-054/154 für Nebenantrieb / for PTO	(82)
				 1878 634 014	420 10 420GSZ	387.053-054/154 für Nebenantrieb / for PTO	(82)
1632 S,1632 LS 387.022 387.224 387.222 387.023/024 387.223	08.73-09.96	OM403	 1800 125 301  1882 301 239  1878 002 706  3151 000 375	420 10 GF420 420GTZ KZIS-4	387.022-024/223/224		
			 3482 124 534 ●	430 GMF430	387.022-024/223/224		
			OM422LA	 1888 042 009	380 GF2/380	01.1980-> für / for: Turbo enthält eine Kupplungsscheibe / This part number includes one clutch disc	(68) (66)
				 1878 000 968 ▽	380 10 380GTZ	01.1980-> für / for: Turbo Lose Kupplungsscheibe / Loose clutch disc	(68) (39)
				 3151 108 031	KZI-4,5	01.1980-> für / for: Turbo	(68)
				 1882 341 001	380 GF2/380	01.1980-> für / for: Turbo In 1888 enthalten / Contained in 1888	(68) (29)
				 1859 250 102	380 GF2/380	01.1980-> für / for: Turbo In 1888 enthalten / Contained in 1888	(68) (29)
				 1878 000 968 △	380 10 380GTZ	01.1980-> für / for: Turbo In 1888 enthalten / Contained in 1888	(68) (29)
	LAPK 1632			 3482 124 522	430 GMF430		
	LP 1632 Turbo	01.80-	OM422LA	 1888 042 009	380 GF2/380	enthält eine Kupplungsscheibe / This part number includes one clutch disc	(66)
 1878 000 968 ▽				380 10 380GTZ	Lose Kupplungsscheibe / Loose clutch disc	(39)	
 3151 108 031				KZI-4,5			
 1882 341 001				380 GF2/380	In 1888 enthalten / Contained in 1888	(29)	
 1859 250 102				380 GF2/380	In 1888 enthalten / Contained in 1888	(29)	
 1878 000 968 △				380 10 380GTZ	In 1888 enthalten / Contained in 1888	(29)	

		CODE				
--	--	------	--	---	---	---

MERCEDES-BENZ







1632						
LP 1632 363.061-067 363.051-057 LPK 1632 363.051-057 363.061-067 LPS 1632 363.051-057 363.061-067		OM403		3482 124 534	430 GMF430	
				1882 301 239 ●	420 GF420	
				1861 410 047 #	420 10 420/ 210GSZ	









1633						
1633,1633 L 620.446 620.096 620.415/416 620.046 620.496	08.73 - 09.96	OM422A, 423		1882 342 134	420 GF420X	620.046/096/446/496
				1878 002 878	420 10 420GTZ	620.046/096/446/496
				3151 110 031	KZI-4,5	620.046/096/446/496
				1882 346 131 #	420 GF420XN	620.046/142-143 für Nebenantrieb / for PTO (82)
				1878 002 706	420 10 420GTZ	620.046/142-143 für Nebenantrieb / for PTO (82)
				1882 342 134	420 GF420X	620.446 Sonderausführung / Special design (56)
1633 S,1633 LS 620.143 620.543 620.142 620.593 620.192/193	08.73 - 09.96	OM422A, 423		1882 342 134	420 GF420X	620.142-143/192-193/543/593
				1878 002 878	420 10 420GTZ	620.142-143/192-193/543/593
				3151 110 031	KZI-4,5	620.142-143/192-193/543/593
				1882 346 131 #	420 GF420XN	620.142-143/192-193/543/593 für Nebenantrieb / for PTO (82)
				1878 002 706	420 10 420GTZ	620.142-143/192-193/543/593 für Nebenantrieb / for PTO (82)







1635						
1635,1635 L 645.426 645.476 645.076 645.026	08.73 - 09.96	OM422A, OM442A		1888 055 041	380 GF2/380	645.026/076/426/476 enthält eine Kupplungsscheibe / This part number includes one clutch disc (66)
				1862 135 035 ▽	380 10 380GS	645.026/076/426/476 Lose Kupplungsscheibe / Loose clutch disc (39)
				3151 108 031	KZI-4,5	645.026/076/426/476
				1882 349 003	380 GF2/380	645.026/076/426/476 In 1888 enthalten / Contained in 1888 (29)
				1859 250 100	380 GF2/380	645.026/076/426/476 In 1888 enthalten / Contained in 1888 (29)
				1862 138 032 △	380 10 380GSZ	645.026/076/426/476 In 1888 enthalten / Contained in 1888 (29)
1635 K 645.127	02.86 - 07.89	OM422A		1888 055 041	380 GF2/380	645.127 enthält eine Kupplungsscheibe / This part number includes one clutch disc (66)
				1862 135 035 ▽	380 10 380GS	645.127 Lose Kupplungsscheibe / Loose clutch disc (39)
				3151 108 031	KZI-4,5	645.127
				1882 349 003	380 GF2/380	645.127 In 1888 enthalten / Contained in 1888 (29)
				1859 250 100	380 GF2/380	645.127 In 1888 enthalten / Contained in 1888 (29)
				1862 138 032 △	380 10 380GSZ	645.127 In 1888 enthalten / Contained in 1888 (29)







		CODE					
--	--	------	--	--	---	---	---

MERCEDES-BENZ

1635							
1635 S,1635 LS 645.522 645.123 645.573 645.122 645.173 645.172 645.523	08.73 - 09.96	OM422A, OM442A		1888 055 041	380 GF2/380	645.122-123/172-173/522-523/573 enthält eine Kupplungsscheibe / This part number includes one clutch disc	(66)
				1862 135 035 ▽	380 10 380GS	645.122-123/172-173/522-523/573 Lose Kupplungsscheibe / Loose clutch disc	(39)
				3151 108 031	KZI-4,5	645.122-123/172-173/522-523/573	
				1882 349 003	380 GF2/380	645.122-123/172-173/522-523/573 In 1888 enthalten / Contained in 1888	(29)
				1859 250 100	380 GF2/380	645.122-123/172-173/522-523/573 In 1888 enthalten / Contained in 1888	(29)
				1862 138 032 △	380 10 380GSZ	645.122-123/172-173/522-523/573 In 1888 enthalten / Contained in 1888	(29)























1636							
1636,1636 L 620.026 620.446 620.416 620.466 620.066	08.73 - 09.96	OM422A, 423		1882 342 134	420 GF420X	620.026	
				1878 002 878	420 10 420GTZ	620.026	
				3151 110 031	KZI-4,5	620.026	
1636 S,1636 LS 620.123 620.122 620.523 620.563	08.73 - 09.96	OM422A, 423		1882 342 134	420 GF420X	620.122-123/523	
				1878 002 878	420 10 420GTZ	620.122-123/523	
				3151 110 031	KZI-4,5	620.122-123/523	
		OM421		1882 342 134	420 GF420X	620.563 Sonderausführung / Special design	(56)
				1878 002 878	420 10 420GTZ	620.563 Sonderausführung / Special design	(56)
				3151 110 031	KZI-4,5	620.563 Sonderausführung / Special design	(56)















1638							
1638 620.086 1638 S,1638 LS 620.583 620.182/183	11.80 - 12.86	OM422LA		1888 042 009	380 GF2/380	620.086/182-183/583 enthält eine Kupplungsscheibe / This part number includes one clutch disc	(66)
	08.73 - 09.96			1878 000 968 ▽	380 10 380GTZ	620.086/182-183/583 Lose Kupplungsscheibe / Loose clutch disc	(39)
				3151 108 031	KZI-4,5	620.086/182-183/583	
				1882 341 001	380 GF2/380	620.086/182-183/583 In 1888 enthalten / Contained in 1888	(29)
				1859 250 102	380 GF2/380	620.086/182-183/583 In 1888 enthalten / Contained in 1888	(29)
				1878 000 968 △	380 10 380GTZ	620.086/182-183/583 In 1888 enthalten / Contained in 1888	(29)

1644							
1644 645.096 1644 S,1644 LS 645.192 645.593 645.193	06.86 - 08.89	OM442LA		1888 055 247	380 GF2/380	645.096/192-193 enthält eine Kupplungsscheibe / This part number includes one clutch disc	(66)
	08.73 - 09.96			1862 123 131 ▽	380 10 380GV	645.096/192-193 Lose Kupplungsscheibe / Loose clutch disc	(39)
				3151 108 031	KZI-4,5	645.096/192-193	
				1882 349 003	380 GF2/380	645.096/192-193 In 1888 enthalten / Contained in 1888	(29)
				1859 250 100	380 GF2/380	645.096/192-193 In 1888 enthalten / Contained in 1888	(29)
				1862 122 132 △	380 10 380GVZ	645.096/192-193 In 1888 enthalten / Contained in 1888	(29)

		CODE					
--	--	------	--	--	---	---	---

































MERCEDES-BENZ

1717								
1717,1717 L 652.415 652.419 652.013/014 652.017 652.417 652.010 652.015 652.019	12.87 - 09.96	OM356	 3400 700 417  3482 000 953  1878 001 144  3151 000 374	350 10 GMF350X 350WGTZ KZIS-4	652.010/013-015/017/019/415/417/419			
			 1882 166 737	380 GF380	652.013-014-015 Sonderausführung / Special design	(56)		
			 1878 001 152	380 10 380WGTZ	652.013-014-015 Sonderausführung / Special design	(56)		
			 3151 000 374	KZIS-4	652.013-014-015 Sonderausführung / Special design	(56)		
1717 AK 652.316 652.316.13	09.89 - 08.94	OM366.952, OM356.940	 3400 125 001  3482 000 953  1878 001 070  3151 000 374	350 10 GMF350X 350GTZ KZIS-4	652.126-127/326			
			 3400 700 417  3482 000 953  1878 001 144  3151 000 374	350 10 GMF350X 350WGTZ KZIS-4	652.316			
1717 K 652.116/117	09.89 - 08.94	OM356	 3400 700 417  3482 000 953  1878 001 144  3151 000 374	350 10 GMF350X 350WGTZ KZIS-4	652.116-117			
			 1882 166 737	380 GF380	652.116-117 Sonderausführung / Special design	(56)		
			 1878 001 152	380 10 380WGTZ	652.116-117 Sonderausführung / Special design	(56)		
			 3151 000 374	KZIS-4	652.116-117 Sonderausführung / Special design	(56)		

1719							
1719 387.006	09.73 - 08.82	OM401	 1882 302 132 #	380 GF380	387.006		
			 1878 000 105	380 10 380GTZ	387.006		
			 3151 000 375	KZIS-4	387.006		
			 1882 302 131	380 GF380	387.006 Sonderausführung / Special design	(56)	
			 1878 000 105	380 10 380GTZ	387.006 Sonderausführung / Special design	(56)	
			 3151 000 375	KZIS-4	387.006 Sonderausführung / Special design	(56)	
			 1882 288 131	380 GF380N	387.006 für Nebenantrieb / for PTO	(82)	
			 1878 000 964	380 10 380GTZ	387.006 für Nebenantrieb / for PTO	(82)	
1719 AK 387.134	09.73 - 08.82	OM401	 1882 302 132 #	380 GF380	387.134		
			 1878 000 105	380 10 380GTZ	387.134		
			 3151 000 375	KZIS-4	387.134		
			 1882 302 131	380 GF380	387.134 Sonderausführung / Special design	(56)	
			 1878 000 105	380 10 380GTZ	387.134 Sonderausführung / Special design	(56)	
			 3151 000 375	KZIS-4	387.134 Sonderausführung / Special design	(56)	







		CODE				
--	--	------	--	---	---	---



MERCEDES-BENZ

















1719						
1719 K 387.033/034	09.73 - 08.82	OM401	 1882 302 132 #	380 GF380	387.033-034	
			 1878 000 105	380 10 380GTZ	387.033-034	
			 3151 000 375	KZIS-4	387.033-034	
			 1882 302 131	380 GF380	387.033-034 Sonderausführung / Special design	(56)
			 1878 000 105	380 10 380GTZ	387.033-034 Sonderausführung / Special design	(56)
			 3151 000 375	KZIS-4	387.033-034 Sonderausführung / Special design	(56)
			 1882 288 131	380 GF380N	387.034 für Nebenantrieb / for PTO	(82)
			 1878 000 964	380 10 380GTZ	387.034 für Nebenantrieb / for PTO	(82)
			 3151 079 031	KZI-6	387.034 für Nebenantrieb / for PTO	(82)
1719 S 387.002	09.73 - 08.82	OM401	 1882 302 132 #	380 GF380		
			 1878 000 105	380 10 380GTZ		
			 3151 000 375	KZIS-4		
			 1882 302 131	380 GF380	Sonderausführung / Special design	(56)
			 1878 000 105	380 10 380GTZ	Sonderausführung / Special design	(56)
			 3151 000 375	KZIS-4	Sonderausführung / Special design	(56)
1720						
1720 677.026 677.024 677.022	01.84 - 12.98	OM366LA	 3482 051 131 #	350 GMF350X	677.022/024	
			 1878 001 070	350 10 350GTZ	677.022/024	
			 3151 000 374	KZIS-4	677.022/024	
1720,1720 L 652.020 652.023 652.029 652.428/429 652.028 652.025 652.436 699.001 652.027 652.024	12.87 - 09.96	OM356	 3400 125 001	350 10 GMF350X	652.020-029/428-429	
			 3482 000 953	350GTZ		
			 1878 001 070	KZIS-4		
			 3151 000 374			
 1882 166 737	380 GF380	652.020-029/428-429				
 1878 001 152	380 10 380WGTZ	652.020-029/428-429				
 3151 000 374	KZIS-4	652.020-029/428-429				
1720 S 652.121	02.90 - 08.94	OM356	 3400 125 001	350 10 GMF350X	652.121	
			 3482 000 953	350GTZ		
			 1878 001 070	KZIS-4		
			 3151 000 374			
1722						
1722 652.033 1722 AK 652.336 1722 AK 652.336 1722 K 652.136 1722 L 652.436 652.439 652.437/438	12.88 - 08.94	OM401.979, OM366.983,	 3400 123 001	430 10 MFZ430		
	12.88 - 08.94	OM356.999, OM401.978,	 3482 081 232	430WGTZ		
	12.88 - 08.94	OM401.973, OM442.907	 1878 080 031	KZISZ-5		
	12.88 - 08.94		 3151 000 549			
	12.88 - 08.94					







		CODE				
--	--	------	--	---	---	---

MERCEDES-BENZ

1722						
1722 652.131/132	08.88 - 08.94	OM441		3482 081 232	430 MFZ430	->Chass. 563495
1722,1722 L, 1722 LL 652.033 652.436 652.034 652.439 652.039 652.035-037 652.437 652.435 652.438 652.038	12.87 - 09.96			1862 225 132 #	400 10 400GTZ	->Chass. 563495
1722, 1722 L, 1722 LL 652.132 652.131 652.478 652.438/439	08.88 - 08.94			3151 000 549	KZISZ-5	->Chass. 563495 für Ausrückgabel mit Rollen / for release fork with rollers (70)
1722 AK 652.336	12.88 - 08.94			3400 123 001  3482 081 232  1878 080 031  3151 000 549	430 10 MFZ430 430WGTZ KZISZ-5	Chass. 563496->
1722 K 652.137 652.136	12.88 - 08.94					
1722 S 652.132 652.131	12.88 - 08.94					























1724						
1724 679.022	01.84 - 12.98	OM366LA		1882 166 737	380 GF380	679.022
				1878 000 105	380 10 380GTZ	679.022
				3151 000 374	KZIS-4	679.022

1726						
1726,1726 L, 1726 LL 652.447 652.045 652.446 652.043 652.047 652.046 652.448	12.87 - 09.96	OM442		3400 124 101  3482 081 232  1878 005 668  3151 000 549	430 10 MFZ430 430WGTZ KZISZ-5	652.346/446-448/541-542/043/045-047/141-142 /146
1726 AK 652.346	06.89 - 08.94			1862 268 031	420 10 420GVZ	652.346/446-448/541-542/043/045-047/141-142 für Nebenantrieb / for PTO (82)
1726 S,1726 LS 652.141 652.542 652.142 652.541	12.87 - 09.96			3151 166 031	KZI-6	652.346/446-448/541-542/043/045-047/141-142 für Nebenantrieb / for PTO (82)
1726 K 652.146	12.88 - 08.94	OM442		3400 124 101  3482 081 232  1878 005 668  3151 000 549	430 10 MFZ430 430WGTZ KZISZ-5	652.146
1726 L, 1726 LL 652.446/447	12.88 - 08.94	OM401.978, OM401.973, OM441.960		3400 124 101  3482 081 232  1878 005 668  3151 000 549	430 10 MFZ430 430WGTZ KZISZ-5	652.446-448
1726 LL 652.448	12.87 - 09.96			1862 268 031	420 10 420GVZ	652.446-448 für Nebenantrieb / for PTO (82)
				3151 166 031	KZI-6	652.446-448 für Nebenantrieb / for PTO (82)

1727						
1727 L 652.448	12.88 - 08.94	OM401.978, OM401.973		3400 124 101  3482 081 232  1878 005 668  3151 000 549	430 10 MFZ430 430WGTZ KZISZ-5	652.446-448
				1862 268 031	420 10 420GVZ	652.446-448 für Nebenantrieb / for PTO (82)
				3151 166 031	KZI-6	652.446-448 für Nebenantrieb / for PTO (82)



































		CODE				
--	--	------	--	---	---	---

MERCEDES-BENZ

1729						
1729 652.045 652.043 652.046	12.87 - 09.96	OM442		1888 063 137	380 GF2/380N	652.043/045-046 Nebenantriebs-ID / PTO ID: 4/125 enthält eine Kupplungsscheibe / This part number includes one clutch disc (48) (66)
				1862 304 033 ▽	380 10 380GV	652.043/045-046 Nebenantriebs-ID / PTO ID: 4/125 Lose Kupplungsscheibe / Loose clutch disc (48) (39)
				3151 166 031	KZI-6	652.043/045-046 Nebenantriebs-ID / PTO ID: 4/125 (48)
				1882 019 133	380 GF2/380N	652.043/045-046 Nebenantriebs-ID / PTO ID: 4/125 In 1888 enthalten / Contained in 1888 (48) (29)
				1859 250 101	380 GF2/380	652.043/045-046 Nebenantriebs-ID / PTO ID: 4/125 In 1888 enthalten / Contained in 1888 (48) (29)
				1862 305 033 △	380 10 380GVZ	652.043/045-046 Nebenantriebs-ID / PTO ID: 4/125 In 1888 enthalten / Contained in 1888 (48) (29)
				1862 268 031	420 10 420GVZ	652.043/045-047 Nebenantriebs-ID / PTO ID: 4/120 (48)
				3151 166 031	KZI-6	652.043/045-047 Nebenantriebs-ID / PTO ID: 4/120 (48)
1729 652.346 652.541 652.446-448 652.043 652.141 652.045-142 652.542 1729 LS 652.542	12.87 - 09.96	OM442		1888 063 137	380 GF2/380N	652.346/446-448/541-542/043/045-047/141-142 Nebenantriebs-ID / PTO ID: 4/125 enthält eine Kupplungsscheibe / This part number includes one clutch disc (48) (66)
				1862 304 033 ▽	380 10 380GV	652.346/446-448/541-542/043/045-047/141-142 Nebenantriebs-ID / PTO ID: 4/125 Lose Kupplungsscheibe / Loose clutch disc (48) (39)
				3151 166 031	KZI-6	652.346/446-448/541-542/043/045-047/141-142 Nebenantriebs-ID / PTO ID: 4/125 (48)
				1882 019 133	380 GF2/380N	652.346/446-448/541-542/043/045-047/141-142 Nebenantriebs-ID / PTO ID: 4/125 In 1888 enthalten / Contained in 1888 (48) (29)
				1859 250 101	380 GF2/380	652.346/446-448/541-542/043/045-047/141-142 In 1888 enthalten / Contained in 1888 (29)
				1862 305 033 △	380 10 380GVZ	652.346/446-448/541-542/043/045-047/141-142 In 1888 enthalten / Contained in 1888 (29)
1728, 1729, 1729 L 655.418 655.416 655.016 655.476 655.015 1729 K 655.117 655.116	07.87 - 09.96	OM442		3400 124 101	430 10 MFZ430 430WGTZ KZISZ-5	
	07.88 - 08.94			3400 122 501	430 10 MFZ430 430WGTZ KZISZ-5	Sonderausführung / Special design (56)
1729 AK 655.316/317	07.88 - 09.93	OM442		3400 124 101	430 10 MFZ430 430WGTZ KZISZ-5	
1729 S, 1729 LS 655.113 655.111/112 655.511-513	07.87 - 09.96	OM442		3400 124 101	430 10 MFZ430 430WGTZ KZISZ-5	
				3400 122 501	430 10 MFZ430 430WGTZ KZISZ-5	Sonderausführung / Special design (56)
				1862 268 031	420 10 420GVZ	655.511-512-513 Nebenantriebs-ID / PTO ID: 4/125 (48)
				3151 166 031	KZI-6	655.511-512-513 Nebenantriebs-ID / PTO ID: 4/125 (48)
1733						
1733, 1733 L, 1734 L 652.068 652.465 652.446/447 652.466 652.468 652.478 652.065 652.067 652.066 652.467 1733 S, 1733 LS 652.563 652.163 652.561/562 652.162 652.161	12.87 - 09.96	OM441		3400 124 001	430 10 MFZ430 430WGTZ KZISZ-5	652.478/561-563/065-068/161-163/465-468
	12.87 - 09.96					





























		CODE					
--	--	------	--	--	---	---	---

MERCEDES-BENZ

1735								
1735,1735 L 655.026 655.476 655.027 655.426 655.076	07.87 - 09.96	OM442A	 3400 122 601  3482 081 231  1878 080 037  3151 000 278	430 10 MFZ430 430WGTZ KZISZ-5				
		OM442.964, OM442.976, OM442.963, OM442.944	 1888 063 137	380 GF2/380N	655.026-027/426 656.116/215 Nebenantriebs-ID / PTO ID: 4/125 enthält eine Kupplungsscheibe / This part number includes one clutch disc	(48) (66)		
			 1862 304 033 ▽	380 10 380GV	655.026-027/426 656.116/215 Nebenantriebs-ID / PTO ID: 4/125 Lose Kupplungsscheibe / Loose clutch disc	(48) (39)		
			 3151 166 031	KZI-6	655.026-027/426 656.116/215 Nebenantriebs-ID / PTO ID: 4/125	(48)		
			 1882 019 133	380 GF2/380N	655.026-027/426 656.116/215 In 1888 enthalten / Contained in 1888	(29)		
			 1859 250 101	380 GF2/380	655.026-027/426 656.116/215 In 1888 enthalten / Contained in 1888	(29)		
			 1862 305 033 △	380 10 380GVZ	655.026-027/426 656.116/215 In 1888 enthalten / Contained in 1888	(29)		
1735 ,AF 656.215 656.116			 1888 063 137	380 GF2/380N	Nebenantriebs-ID / PTO ID: 4/125 enthält eine Kupplungsscheibe / This part number includes one clutch disc	(48) (66)		
			 1862 304 033 ▽	380 10 380GV	Nebenantriebs-ID / PTO ID: 4/125 Lose Kupplungsscheibe / Loose clutch disc	(48) (39)		
			 3151 166 031	KZI-6	Nebenantriebs-ID / PTO ID: 4/125	(48)		
			 1882 019 133	380 GF2/380N	In 1888 enthalten / Contained in 1888	(29)		
			 1859 250 101	380 GF2/380	In 1888 enthalten / Contained in 1888	(29)		
			 1862 305 033 △	380 10 380GVZ	In 1888 enthalten / Contained in 1888	(29)		
			OM442	 3400 124 101  3482 081 232  1878 005 668  3151 000 549	430 10 MFZ430 430WGTZ KZISZ-5			
1735 AK 655.327 1735 K 655.127 1735 L 655.476 1735 S,1735 LS 655.573 655.122 655.523 655.173 655.123 655.572 655.522 655.172	08.89 - 08.94	OM442A	 3400 122 601  3482 081 231  1878 080 037  3151 000 278	430 10 MFZ430 430WGTZ KZISZ-5				
	07.88 - 08.94							
	07.88 - 08.94	OM442LA	 3400 121 601  3488 017 432  1878 634 022  3151 000 547	400 10 MFZ2/400X 400GVZ KZISZ-5	Sonderausführung / Special design	(56)		
	07.87 - 09.96	OM442.964, OM442.966, OM442.906, OM442.976, OM442.963, OM442.944, OM440.940, OM442.942	 1888 063 137	380 GF2/380N	Nebenantriebs-ID / PTO ID: 4/125 enthält eine Kupplungsscheibe / This part number includes one clutch disc	(48) (66)		
			 1862 304 033 ▽	380 10 380GV	Nebenantriebs-ID / PTO ID: 4/125 Lose Kupplungsscheibe / Loose clutch disc	(48) (39)		
			 3151 166 031	KZI-6	Nebenantriebs-ID / PTO ID: 4/125	(48)		
			 1882 019 133	380 GF2/380N	In 1888 enthalten / Contained in 1888	(29)		
			 1859 250 101	380 GF2/380	In 1888 enthalten / Contained in 1888	(29)		
			 1862 305 033 △	380 10 380GVZ	In 1888 enthalten / Contained in 1888	(29)		

		CODE				
--	--	------	--	---	---	---



MERCEDES-BENZ







1748						
1748,1748 L 655.096 655.496 655.494	07.87 - 09.96	OM442LA	 3400 121 601 ⊗ 3488 017 432 ⊗ 1878 634 022 ⊙ 3151 000 547	400 10 MFZ2/400X 400GVZ KZISZ-5	->Chass. K 011863 655.096/494	
			 3400 121 601 ⊗ 3488 017 432 ⊗ 1878 634 022 ⊙ 3151 000 547	400 10 MFZ2/400X 400GVZ KZISZ-5	655.496	
			 3482 081 233	430 MFZ430	Chass. K 011864-> 655.096/494	
			 1878 002 735	430 10 430GTZ	Chass. K 011864-> 655.096/494	
			 3151 000 278	KZISZ-5	Chass. K 011864-> 655.096/494	
1748 S,1748 LS 655.192 655.592/593 655.193	07.87 - 09.96	OM442LA	 3400 121 601 ⊗ 3488 017 432 ⊗ 1878 634 022 ⊙ 3151 000 547	400 10 MFZ2/400X 400GVZ KZISZ-5	->Chass. K 011863 655.494/496/592-593/096/192-193	
			 1888 063 137	380 GF2/380N	655.192 für Nebenantrieb / for PTO enthält eine Kupplungsscheibe / This part number includes one clutch disc	(82) (66)
		OM442.985, OM442.989	 1862 304 033 ▽	380 10 380GV	655.192 für Nebenantrieb / for PTO Lose Kupplungsscheibe / Loose clutch disc	(82) (39)
		 3151 166 031	KZI-6	655.192 für Nebenantrieb / for PTO	(82)	
		 1882 019 133	380 GF2/380N	655.192 In 1888 enthalten / Contained in 1888	(29)	
		 1859 250 101	380 GF2/380	655.192 In 1888 enthalten / Contained in 1888	(29)	
		 1862 305 033 △	380 10 380GVZ	655.192 In 1888 enthalten / Contained in 1888	(29)	
1813						
1813 6x2		OM352	 1882 201 132	295 GF295		
			 1861 279 133	295 10 295GTZ		
			 3151 095 043	KZI-3		
L 1813 352.408 352.401-403 352.407		OM352	 1882 252 331	310 GFX310	->Chass. 922885	
			 1882 305 131	310 GFX310	Chass. 922886->	
			 1861 303 248	310 10 310GSB		
			 3151 095 043	KZI-3		
L 1813 L 1813		OM352A	 1882 252 333	310 GFX310		
			 1861 303 248	310 10 310GSB		
1814						
1814 616.006	04.84 - 03.91	OM366	 3400 122 401 ⊗ 3482 008 038 ⊗ 1861 964 034 ⊙ 3151 044 031	310 10 MF310 310WGSZ KZI-3	616.004/006-007-008	
1817						
L 1817 360.401-403		OM360	 1882 234 433	350 GF350		
			 1878 001 074	350 10 350GTZ		
			 3151 094 041	KZI-4		
LP 1817	06.69 -	OM324	 1882 234 433	350 GF350		
			 1878 001 074	350 10 350GTZ		
			 3151 044 031	KZI-3		

		CODE				
--	--	------	--	---	---	---

MERCEDES-BENZ

1817						
LP 1817	-05.69	OM324		1878 001 074	350 10 350GTZ	



















1819						
1819 6x4 L 327				1882 234 433	350 GF350	
				1878 001 074	350 10 350GTZ	
L 1819 360.401-403		OM360		1882 234 433	350 GF350	
				1878 001 074	350 10 350GTZ	
				3151 094 041	KZI-4	

1820						
1820,1820 L 652.028 652.025 652.029 652.428/429 652.023 652.420 652.027 652.020 652.024	12.87 - 09.96	OM357.925, OM356.984, OM356.987		3400 125 001 ⊗ 3482 000 953 ⊗ 1878 001 070 ⊙ 3151 000 374	350 10 GMF350X 350GTZ KZIS-4	652.428-429/020-029/316
				1882 166 737	380 GF380	652.013-015/023-025/110-119/310-319
		OM356		1878 001 152	380 10 380WGTZ	652.013-015/023-025/110-119/310-319
				3151 000 374	KZIS-4	652.013-015/023-025/110-119/310-319
1820 AK 652.326 652.316	07.93 - 09.96	OM357.925, OM356.987		3400 125 001 ⊗ 3482 000 953 ⊗ 1878 001 070 ⊙ 3151 000 374	350 10 GMF350X 350GTZ KZIS-4	652.126-127/326
				3400 700 417 ⊗ 3482 000 953 ⊗ 1878 001 144 ⊙ 3151 000 374	350 10 GMF350X 350WGTZ KZIS-4	652.316
1820 K 652.126/127	05.92 - 09.96	OM357.925, OM356.987		3400 125 001 ⊗ 3482 000 953 ⊗ 1878 001 070 ⊙ 3151 000 374	350 10 GMF350X 350GTZ KZIS-4	652.126-127/326

1824						
1824 652.004 652.007-009 652.006 652.003 652.005	01.94 - 09.96	OM401LA, 441LA		3400 700 411 ⊗ 3482 081 232 ⊗ 1878 080 033 ⊙ 3151 000 278	430 10 MFZ430 430WGTZ KZISZ-5	652.302-303/405-409/003-009/106-107
	12.87 - 09.96					
1824,1824 L 652.009 652.407/408 652.008 652.003 652.406 652.004 652.006 652.405 652.007 652.409 652.005	08.92 - 09.96					
	01.94 - 09.96					
1824 AK 652.302 652.336 652.303	08.92 - 09.96					
1824 AK 652.303 652.302	01.94 - 09.96					
1824 K 652.106/107	08.92 - 09.96					
1824 K 652.107 652.106	01.94 - 09.96					























		CODE				
--	--	------	--	---	---	---





MERCEDES-BENZ

1827							
1827,1827 L 652.455 652.059 652.053 652.055 652.057/058 652.457 652.456 652.458 652.054 652.056 652.459 1827,1827 L 652.455 652.457 652.059 652.053 652.056 652.058 652.456 652.459 652.054 652.458 652.055 652.057	12.87 - 09.96	OM401.977, OM445.936, OM401.991, OM445.926, OM401.973		1888 063 137	380 GF2/380N	652.053-059/151-153 für Nebenantrieb / for PTO enthält eine Kupplungsscheibe / This part number includes one clutch disc (82) (66)	
	12.87 - 09.96				1862 304 033 ▽	380 10 380GV	652.053-059/151-153 für Nebenantrieb / for PTO Lose Kupplungsscheibe / Loose clutch disc (82) (39)
					3151 166 031	KZI-6	652.053-059/151-153 für Nebenantrieb / for PTO (82)
					1882 019 133	380 GF2/380N	652.053-059/151-153 In 1888 enthalten / Contained in 1888 (29)
					1859 250 101	380 GF2/380	652.053-059/151-153 In 1888 enthalten / Contained in 1888 (29)
					1862 305 033 △	380 10 380GVZ	652.053-059/151-153 In 1888 enthalten / Contained in 1888 (29)
					3400 700 411 ● 3482 081 232 ● 1878 080 033 ● 3151 000 278	430 10 MFZ430 430WGTZ KZISZ-5	652.053-059/455-459/551-553
08.92 - 09.96	OM401.989, OM401.973, OM445.933		3400 700 411 ● 3482 081 232 ● 1878 080 033 ● 3151 000 278	430 10 MFZ430 430WGTZ KZISZ-5			
08.92 - 09.96							
1827 S,1827 LS 652.551 652.153 652.152 652.552/553 652.151 1827 S,1827 LS 652.553 652.151-153 652.551/552	12.87 - 09.96	OM401.977, OM445.936, OM401.991, OM445.926, OM401.973		3482 081 232	430 MFZ430	652.151-153	
	12.87 - 09.96				1878 080 033	430 10 430WGTZ	652.151-153
					3151 000 549	KZISZ-5	652.151-153 für Ausrückgabel mit Rollen / for release fork with rollers (70)
					1888 063 137	380 GF2/380N	652.053-059/151-153 für Nebenantrieb / for PTO enthält eine Kupplungsscheibe / This part number includes one clutch disc (82) (66)
					1862 304 033 ▽	380 10 380GV	652.053-059/151-153 für Nebenantrieb / for PTO Lose Kupplungsscheibe / Loose clutch disc (82) (39)
					3151 166 031	KZI-6	652.053-059/151-153 für Nebenantrieb / for PTO (82)
					1882 019 133	380 GF2/380N	652.053-059/151-153 In 1888 enthalten / Contained in 1888 (29)
					1859 250 101	380 GF2/380	652.053-059/151-153 In 1888 enthalten / Contained in 1888 (29)
					1862 305 033 △	380 10 380GVZ	652.053-059/151-153 In 1888 enthalten / Contained in 1888 (29)
					3400 700 411 ● 3482 081 232 ● 1878 080 033 ● 3151 000 278	430 10 MFZ430 430WGTZ KZISZ-5	652.053-059/455-459/551-553
	OM401LA, 441LA						

		CODE					
--	--	------	--	--	---	---	---

















MERCEDES-BENZ

1831							
1831,1831 L 655.102 655.007 655.406 655.409 655.006 655.008 655.101 655.408 655.005 655.407 655.009 655.405 655.103 1831,1831 L 655.406 655.409 655.006 655.009 655.103 655.407 655.007/008 655.101 655.005 655.102 655.405 655.408 1831 AK 655.307 1831 AK 655.307 1831 K 655.107 1831 K 655.107 1831 S,1831 LS 655.103 655.508 655.102 655.503 655.502 655.501 1831 S,1831 LS 655.102 655.508 655.501 655.103 655.502/503	07.87 - 09.96 07.87 - 09.96 05.91 - 09.96 01.94 - 09.96 07.92 - 09.96 07.92 - 09.96 07.87 - 09.96 07.87 - 09.96	OM401LA, 441LA OM442A OM401.979, OM445.937, OM401.972, OM401.993, OM445.929	 3400 124 001  3482 081 231  1878 634 027  3151 000 278	430 10 MFZ430 430WGTZ KZISZ-5	652.405-409/501-503/508/095-097/495-498 /591-593 655.005-009/101-103/107/307		
1831,1831 L 652.098 652.192 652.497 652.191 652.498 652.496 652.096/097 652.495 652.095 652.193 1831,1831 L 652.097/098 652.191 652.495 652.096 652.192 652.498 652.496 652.095 652.193 652.497 1831 S,1831 LS 652.192 652.591 652.593 652.592 652.193 652.191 1831 S,1831 LS 652.192 652.593 652.591 652.193 652.592 652.191	12.87 - 09.96 12.87 - 09.96 12.87 - 09.96 12.87 - 09.96	OM401LA, 441LA OM442A OM401.979, OM445.937, OM401.972, OM401.993, OM445.929	 3400 124 001  3482 081 231  1878 634 027  3151 000 278	430 10 MFZ430 430WGTZ KZISZ-5	652.405-409/501-503/508/095-097/495-498 /591-593 655.005-009/101-103/107/307		
			 3400 122 601  3482 081 231  1878 080 037  3151 000 278	430 10 MFZ430 430WGTZ KZISZ-5	652.095-096-097-098/191-192-193		
			 1888 063 137	380 GF2/380N	652.095-098/191-193 für Nebenantrieb / for PTO enthält eine Kupplungsscheibe / This part number includes one clutch disc	(82)	(66)
			 1862 304 033 ▽	380 10 380GV	652.095-098/191-193 für Nebenantrieb / for PTO Lose Kupplungsscheibe / Loose clutch disc	(82)	(39)
			 3151 166 031	KZI-6	652.095-098/191-193 für Nebenantrieb / for PTO	(82)	
			 1882 019 133	380 GF2/380N	652.095-098/191-193 In 1888 enthalten / Contained in 1888	(29)	
			 1859 250 101	380 GF2/380	652.095-098/191-193 In 1888 enthalten / Contained in 1888	(29)	
			 1862 305 033 △	380 10 380GVZ	652.095-098/191-193 In 1888 enthalten / Contained in 1888	(29)	
1831 LAS 652.303		OM441LA	 3400 700 411  3482 081 232  1878 080 033  3151 000 278	430 10 MFZ430 430WGTZ KZISZ-5			

1834							
1834,1834 L 655.020 655.023 655.021 655.421 655.420 655.022 655.423 655.422 1834,1834 L 652.065/066 652.467 652.478 652.465 652.067/068 652.466 652.468 1834 S,1834 LS 655.142 655.542/543 655.141 655.143 655.541 655.548 1834 S,1834 LS 652.163 652.563 652.161/162 652.561/562	07.87 - 09.96 12.87 - 09.96 07.87 - 09.96 12.87 - 09.96	OM401LA, 441LA	 3400 124 001  3482 081 231  1878 634 027  3151 000 278	430 10 MFZ430 430WGTZ KZISZ-5	652.420-423/541-543/548/065-068/161-163/562 /563 655.020-023/107/141-143/307		



















		CODE				
--	--	------	--	---	---	---

MERCEDES-BENZ

1838							
1838 655.133 655.132 655.138 655.533 655.538 655.582/583 655.437 655.532 655.588 655.436 655.484 655.035-038 655.087 655.182 655.337 655.086 655.434 655.183 655.486/487		OM402LA, 442LA		3400 122 901  3482 081 233  1878 002 735  3151 000 278	430 10 MFZ430 430GTZ KZISZ-5	für / for: SA033617-01 655.182-183/337/434/436-437/484/486-487/532 /533/538/582-583/588/035-038/086-087/132-133 /138	(68)
1838,1838 L 655.132 655.435 655.484 655.036 655.183 655.436 655.086 655.485 655.487 655.087 655.138 655.035 655.037 655.434 655.486 655.182	07.87 - 09.96	OM402LA, 442LA		3400 122 601  3482 081 231  1878 080 037  3151 000 278	430 10 MFZ430 430WGTZ KZISZ-5	655.182-183/337/434/436-437/484/486-487/532 /533/538/582-583/588/035-038/086-087/132-133 /138	
1838,1838 L 655.487 655.036/037 655.436 655.038 655.138 655.183 655.486 655.035 655.182 655.434 655.437 655.132	07.87 - 09.96	OM402, OM442LA		3488 017 432	400 MFZ2/400X	für OE-Nummer / for OE number 005 250 88 04 für OE-Nummer / for OE number 005 250 76 04 für OE-Nummer / for OE number 005 250 77 04 enthält eine Kupplungsscheibe / This part number includes one clutch disc Sonderausführung / Special design	(83) (83) (83) (66)
1838,1838 L 655.437 655.038 655.037 655.434 655.035/036 655.436	07.87 - 09.96			1878 634 022 #	400 10 400GVZ	für OE-Nummer / for OE number 014 250 70 03 für OE-Nummer / for OE number 014 250 08 03 Sonderausführung / Special design	(83) (83) (56)
1838 K 655.138	12.90 - 09.96			1878 005 805	400 10 400GTZ	für OE-Nummer / for OE number 014 250 70 03 für OE-Nummer / for OE number 014 250 08 03 Sonderausführung / Special design	(83) (83) (56)
1838 K 655.138	06.95 - 09.96			3151 000 278	KZISZ-5	für OE-Nummer / for OE number 001 250 65 15 für OE-Nummer / for OE number 001 250 64 15 für OE-Nummer / for OE number 001 250 98 15 für OE-Nummer / for OE number 001 250 86 15 für OE-Nummer / for OE number 001 250 79 15 Sonderausführung / Special design	(83) (83) (83) (83) (83) (56)
1838 S,1838 LS 655.532 655.182/183 655.533 655.588 655.132/133 655.582/583	07.87 - 09.96			1888 063 137	380 GF2/380N	655.182-183/337/434/436-437/486-487/532-533 /582-583/035-038/086-087/132-133/138 für Nebenantrieb / for PTO enthält eine Kupplungsscheibe / This part number includes one clutch disc	(82) (66)
1838 S,1838 LS 655.133 655.132 655.533 655.583 655.532 655.582 655.588 655.538	07.87 - 09.96	OM402.971, OM402.975, OM440.978, OM446.943, OM402.985,		1862 304 033 ▽	380 10 380GV	655.182-183/337/434/436-437/486-487/532-533 /582-583/035-038/086-087/132-133/138 für Nebenantrieb / for PTO Lose Kupplungsscheibe / Loose clutch disc	(82) (39)
1838 S,1838 LS 655.133 655.533 655.588 655.532 655.132 655.538	07.87 - 09.96	OM446.925, OM440.991, OM402.986, OM446.924, OM402.972		3151 166 031	KZI-6	655.182-183/337/434/436-437/486-487/532-533 /582-583/035-038/086-087/132-133/138 für Nebenantrieb / for PTO	(82)
				1882 019 133	380 GF2/380N	655.182-183/337/434/436-437/486-487/532-533 /582-583/035-038/086-087/132-133/138 In 1888 enthalten / Contained in 1888	(29)
				1859 250 101	380 GF2/380	655.182-183/337/434/436-437/486-487/532-533 /582-583/035-038/086-087/132-133/138 In 1888 enthalten / Contained in 1888	(29)
				1862 305 033 △	380 10 380GVZ	655.182-183/337/434/436-437/486-487/532-533 /582-583/035-038/086-087/132-133/138 In 1888 enthalten / Contained in 1888	(29)

















































		CODE				
--	--	------	--	---	---	---

MERCEDES-BENZ

1838								
1838 AK 655.337 1838 AK 655.337 1838 AK 655.337 1838 AK 655.337 1838 AK 655.337 OM446.927, OM402.996, OM440.979, OM402.978, OM440.982	12.92 - 09.96	OM402LA, 442LA		3400 122 601  3482 081 231  1878 080 037  3151 000 278	430 10 MFZ430 430WGTZ KZISZ-5	655.182-183/337/434/436-437/484/486-487/532/533/538/582-583/588/035-038/086-087/132-133/138		
	01.94 - 09.96							
	12.92 - 09.96				3400 122 901  3482 081 233  1878 002 735  3151 000 278	430 10 MFZ430 430GTZ KZISZ-5	für / for: SA033617-01 655.182-183/337/434/436-437/484/486-487/532/533/538/582-583/588/035-038/086-087/132-133/138	(68)
	12.92 - 09.96		OM402, OM442LA		3488 017 432	400 MFZ2/400X	für OE-Nummer / for OE number 005 250 88 04 für OE-Nummer / for OE number 005 250 76 04 für OE-Nummer / for OE number 005 250 77 04 enthält eine Kupplungsscheibe / This part number includes one clutch disc Sonderausführung / Special design	(83) (83) (83) (66)
					1878 634 022 #	400 10 400GVZ	für OE-Nummer / for OE number 014 250 70 03 für OE-Nummer / for OE number 014 250 08 03 Sonderausführung / Special design	(83) (83) (56)
					1878 005 805	400 10 400GTZ	für OE-Nummer / for OE number 014 250 70 03 für OE-Nummer / for OE number 014 250 08 03 Sonderausführung / Special design	(83) (83) (56)
					3151 000 278	KZISZ-5	für OE-Nummer / for OE number 001 250 65 15 für OE-Nummer / for OE number 001 250 64 15 für OE-Nummer / for OE number 001 250 98 15 für OE-Nummer / for OE number 001 250 86 15 für OE-Nummer / for OE number 001 250 79 15 Sonderausführung / Special design	(83) (83) (83) (83) (83) (56)
					1888 063 137	380 GF2/380N	655.182-183/337/434/436-437/486-487/532-533/582-583/035-038/086-087/132-133/138 für Nebenantrieb / for PTO enthält eine Kupplungsscheibe / This part number includes one clutch disc	(82) (66)
					1862 304 033 ▽	380 10 380GV	655.182-183/337/434/436-437/486-487/532-533/582-583/035-038/086-087/132-133/138 für Nebenantrieb / for PTO Lose Kupplungsscheibe / Loose clutch disc	(82) (39)
					3151 166 031	KZI-6	655.182-183/337/434/436-437/486-487/532-533/582-583/035-038/086-087/132-133/138 für Nebenantrieb / for PTO	(82)
					1882 019 133	380 GF2/380N	655.182-183/337/434/436-437/486-487/532-533/582-583/035-038/086-087/132-133/138 In 1888 enthalten / Contained in 1888	(29)
					1859 250 101	380 GF2/380	655.182-183/337/434/436-437/486-487/532-533/582-583/035-038/086-087/132-133/138 In 1888 enthalten / Contained in 1888	(29)
					1862 305 033 △	380 10 380GVZ	655.182-183/337/434/436-437/486-487/532-533/582-583/035-038/086-087/132-133/138 In 1888 enthalten / Contained in 1888	(29)
					3483 023 032 ⊕	445 GMFZ445W	655.337 für Fahrzeuge mit Wandlerschaltkupplung / for vehicles with converter and clutch unit	(76)
					1878 003 780	445 24 445GTZ	655.337 für Fahrzeuge mit Wandlerschaltkupplung / for vehicles with converter and clutch unit	(76)















		CODE				
--	--	------	--	---	---	---

MERCEDES-BENZ

1844						
1844 655.434 655.035-037 655.436 655.337 655.138 655.533 655.437		OM402LA, 442LA	 3400 122 601  3482 081 231  1878 080 037  3151 000 278	430 10 MFZ430 430WGTZ KZISZ-5		
			 3400 122 901  3482 081 233  1878 002 735  3151 000 278	430 10 MFZ430 430GTZ KZISZ-5	für / for: SA033617-01	(68)
		 1888 063 137	380 GF2/380N	Nebenantriebs-ID / PTO ID: 4/125 enthält eine Kupplungsscheibe / This part number includes one clutch disc	(48) (66)	
		 1862 304 033 ▽	380 10 380GV	Nebenantriebs-ID / PTO ID: 4/125 Lose Kupplungsscheibe / Loose clutch disc	(48) (39)	
		 3151 166 031	KZI-6	Nebenantriebs-ID / PTO ID: 4/125	(48)	
		 1882 019 133	380 GF2/380N	In 1888 enthalten / Contained in 1888	(29)	
		 1859 250 101	380 GF2/380	In 1888 enthalten / Contained in 1888	(29)	
		 1862 305 033 △	380 10 380GVZ	In 1888 enthalten / Contained in 1888	(29)	
		 3483 023 032 ⊕	445 GMFZ445W	655.337 für Fahrzeuge mit Wandlerschaltkupplung / for vehicles with converter and clutch unit	(76)	
		 1878 003 780	445 24 445GTZ	655.337 für Fahrzeuge mit Wandlerschaltkupplung / for vehicles with converter and clutch unit	(76)	
1844,1844 L 655.190 655.138 655.037 655.093 655.434 655.490 655.492 655.436 655.035/036 655.191 655.337 655.437	07.87 - 09.96	OM442LA	 3400 121 601  3488 017 432  1878 634 022  3151 000 547	400 10 MFZ2/400X 400GVZ KZISZ-5	->Chass. K011863 655.590-591/593/093/190-191/490/492	
			 3400 122 901  3482 081 233  1878 002 735  3151 000 278	430 10 MFZ430 430GTZ KZISZ-5	Chass. K011864-> 655.590-591/593/093/190-191/490/492	
		 3483 023 032 ⊕	445 GMFZ445W	655.337 für Fahrzeuge mit Wandlerschaltkupplung / for vehicles with converter and clutch unit	(76)	
		 1878 003 780	445 24 445GTZ	655.337 für Fahrzeuge mit Wandlerschaltkupplung / for vehicles with converter and clutch unit	(76)	
1844 S,1844 LS 655.190 655.590/591 655.191 655.533	07.87 - 09.96	OM442LA	 3400 121 601  3488 017 432  1878 634 022  3151 000 547	400 10 MFZ2/400X 400GVZ KZISZ-5	->Chass. K011863 655.590-591/593/093/190-191/490/492	
			 3400 122 901  3482 081 233  1878 002 735  3151 000 278	430 10 MFZ430 430GTZ KZISZ-5	Chass. K011864-> 655.590-591/593/093/190-191/490/492	
1850						
1850,1850 L 655.494 655.337 655.096 655.496	07.87 - 09.96	OM442LA	 3400 121 601  3488 017 432  1878 634 022  3151 000 547	400 10 MFZ2/400X 400GVZ KZISZ-5	->Chass. K011863 655.494/496/592-593/096/192-193	
			 3400 122 901  3482 081 233  1878 002 735  3151 000 278	430 10 MFZ430 430GTZ KZISZ-5	Chass. K011864-> 655.494/496/592-593/096/192-193	
			 3400 121 601  3488 017 432  1878 634 022  3151 000 547	400 10 MFZ2/400X 400GVZ KZISZ-5	für / for: SA33613-03	(68)
		 3483 023 032 ⊕	445 GMFZ445W	655.337 für Fahrzeuge mit Wandlerschaltkupplung / for vehicles with converter and clutch unit	(76)	
		 1878 003 780	445 24 445GTZ	655.337 für Fahrzeuge mit Wandlerschaltkupplung / for vehicles with converter and clutch unit	(76)	



























		CODE					
--	--	------	--	--	---	---	---

MERCEDES-BENZ

1850									
1850 655.133 655.337 655.127 655.138		OM442LA		3400 122 601 ● 3482 081 231 ● 1878 080 037 ◆ 3151 000 278	430 10 MFZ430 430WGTZ KZISZ-5				
				3400 122 901 ● 3482 081 233 ● 1878 002 735 ◆ 3151 000 278	430 10 MFZ430 430GTZ KZISZ-5	für / for: SA033617-01	(68)		
						1888 063 137	380 GF2/380N	Nebenantriebs-ID / PTO ID: 4/125 enthält eine Kupplungsscheibe / This part number includes one clutch disc	(48) (66)
						1862 304 033 ▽	380 10 380GV	Nebenantriebs-ID / PTO ID: 4/125 Lose Kupplungsscheibe / Loose clutch disc	(48) (39)
						3151 166 031	KZI-6	Nebenantriebs-ID / PTO ID: 4/125	(48)
						1882 019 133	380 GF2/380N	In 1888 enthalten / Contained in 1888	(29)
						1859 250 101	380 GF2/380	In 1888 enthalten / Contained in 1888	(29)
						1862 305 033 △	380 10 380GVZ	In 1888 enthalten / Contained in 1888	(29)
						3483 023 032 ⊕	445 GMFZ445W	655.337 für Fahrzeuge mit Wandlerschaltkupplung / for vehicles with converter and clutch unit	(76)
						1878 003 780	445 24 445GTZ	655.337 für Fahrzeuge mit Wandlerschaltkupplung / for vehicles with converter and clutch unit	(76)
1850 LAS 655.592 1850 S,1850 LS 655.193 655.192 655.133 655.592/593	07.87 - 09.96	OM442LA		3400 121 601 ● 3488 017 432 ● 1878 634 022 ◆ 3151 000 547	400 10 MFZ2/400X 400GVZ KZISZ-5	->Chass. K011863 655.494/496/592-593/096/192-193			
	07.87 - 09.96			3400 122 901 ● 3482 081 233 ● 1878 002 735 ◆ 3151 000 278	430 10 MFZ430 430GTZ KZISZ-5	Chass. K011864-> 655.494/496/592-593/096/192-193			
				3400 121 601 ● 3488 017 432 ● 1878 634 022 ◆ 3151 000 547	400 10 MFZ2/400X 400GVZ KZISZ-5	für / for: SA33613-03	(68)		
1853									
1853,1853 L 655.494 655.496 655.096 1853 S,1853 LS 655.192 655.592 655.193 655.593	07.87 - 09.96	OM442LA		3400 121 601 ● 3488 017 432 ● 1878 634 022 ◆ 3151 000 547	400 10 MFZ2/400X 400GVZ KZISZ-5	->Chass. K011863 655.593			
	07.87 - 09.96			3400 122 901 ● 3482 081 233 ● 1878 002 735 ◆ 3151 000 278	430 10 MFZ430 430GTZ KZISZ-5	Chass. K118864-> 655.593			

		CODE				
--	--	------	--	---	---	---











MERCEDES-BENZ

1853							
1853 AK 655.337	01.96 - 09.96	OM442LA	 3400 122 601 ⊗ 3482 081 231 ⊗ 1878 080 037 ⊙ 3151 000 278	430 10 MFZ430 430WGTZ KZISZ-5			
			 3400 122 901 ⊗ 3482 081 233 ⊗ 1878 002 735 ⊙ 3151 000 278	430 10 MFZ430 430GTZ KZISZ-5	für / for: SA033617-01	(68)	
		OM402, OM442LA	 3400 121 601 ⊗ 3488 017 432 ⊗ 1878 634 022 ⊙ 3151 000 547	400 10 MFZ2/400X 400GVZ KZISZ-5	für / for: SA25801-03	(68)	
		OM446.920, OM446.946	 <u>1888 063 137</u>	380 GF2/380N	für Nebenantrieb / for PTO enthält eine Kupplungsscheibe / This part number includes one clutch disc	(82) (66)	
	 <u>1862 304 033</u> ▽		380 10 380GV	für Nebenantrieb / for PTO Lose Kupplungsscheibe / Loose clutch disc	(82) (39)		
	 <u>3151 166 031</u>		KZI-6	für Nebenantrieb / for PTO	(82)		
	 1882 019 133		380 GF2/380N	In 1888 enthalten / Contained in 1888	(29)		
	 1859 250 101		380 GF2/380	In 1888 enthalten / Contained in 1888	(29)		
	 1862 305 033 △		380 10 380GVZ	In 1888 enthalten / Contained in 1888	(29)		
	 3483 023 032 ⊕		445 GMFZ445W	655.337 für Fahrzeuge mit Wandlerschaltkupplung / for vehicles with converter and clutch unit	(76)		
	 1878 003 780	445 24 445GTZ	655.337 für Fahrzeuge mit Wandlerschaltkupplung / for vehicles with converter and clutch unit	(76)			
	1918						
	L 1918 349 LK 1918 349			 1882 110 542	350 GF350		
			 1861 034 147 #	350 10 350			
LS 1918		OM346	 1882 166 737	380 GF380			
			 1863 010 100	GR-4	mit Anlauftring / with thrust ring	(88)	
1919							
1919 389.006 389.008/009 389.007	05.74 - 08.82	OM401	 1882 302 131	380 GF380	389.006-007-008-009		
			 1878 000 105	380 10 380GTZ	389.006-007-008-009 Sonderausführung / Special design	(56)	
			 1882 302 132 #	380 GF380	389.006-007-008-009		
			 1878 000 105	380 10 380GTZ	389.006-007-008-009		
			 3151 000 375	KZIS-4	389.006-007-008-009		
		OM401.909, OM401.916	 1882 288 131	380 GF380N	389.006-007/034 für Nebenantrieb / for PTO	(82)	
		 1878 000 964	380 10 380GTZ	389.006-007/034 für Nebenantrieb / for PTO	(82)		
1919 AK 389.134	05.74 - 08.82	OM401	 1882 302 131	380 GF380			
			 1882 302 132 #	380 GF380			
			 1878 000 105	380 10 380GTZ			
			 3151 000 375	KZIS-4			



		CODE				
--	--	------	--	---	---	---

MERCEDES-BENZ









1919

1919 K 389.034	05.74 - 08.82	OM401		1882 302 131	380 GF380	389.034		
				1882 302 132 #	380 GF380	389.034		
				1878 000 105	380 10 380GTZ	389.034		
				3151 000 375	KZIS-4	389.034		
			OM401.909		1882 288 131	380 GF380N	389.006-007/034 für Nebenantrieb / for PTO	(82)
				1878 000 964	380 10 380GTZ	389.006-007/034 für Nebenantrieb / for PTO	(82)	
1919 S 389.003 389.002	05.74 - 08.82	OM401		1882 302 131	380 GF380	389.002-003		
				1882 302 132 #	380 GF380	389.002-003		
				1878 000 105	380 10 380GTZ	389.002-003		
				3151 000 375	KZIS-4	389.002-003		

1920



































L,LA,LK,LP,LS,LPS 1920				1882 166 737	380 GF380		
				1878 000 104	380 10 380GTZ		

1921

1921 349				1882 110 542	350 GF350		
				1861 034 147 #	350 10 350		
				1882 166 737	380 GF380		
				1878 000 104	380 10 380GTZ		
				3151 000 529	KZIS-4		
L 1921 349.313 349.311 349.314 LK 1921 349.313/314 349.311 LS 1921 349.314 349.313 349.311		OM355		1882 166 737	380 GF380		
				1878 000 104	380 10 380GTZ		
				3151 000 529	KZIS-4		



























		CODE				
--	--	------	--	---	---	---

MERCEDES-BENZ

1922						
1922 621.006 621.005 621.007/008	10.81 - 10.90	OM421	 1882 302 131	380 GF380	-> Chass. 234953 621.005-008	
			 1878 000 105	380 10 380GTZ	-> Chass. 234953 621.005-008	
			 3151 000 375	KZIS-4	-> Chass. 234953 621.005-008	
			 3482 124 541	430 GMF430	Chass. 234954-> 621.005-008	
			 1882 301 238 ●#	420 GF420	Chass. 234954-> 621.005-008	
			 1878 002 706	420 10 420GTZ	Chass. 234954-> 621.005-008	
			 3151 000 375	KZIS-4	Chass. 234954-> 621.005-008	
			 3482 124 541	430 GMF430	621.007-008	
			 1882 301 238 ●#	420 GF420	621.007-008	
			 1878 001 136	420 10 420GTZ	621.007-008	
			 3151 000 375	KZIS-4	621.007-008	
			 1861 643 134 #	420 10 420GSZ	621.005/106-107 für Nebenantrieb / for PTO	(82)
			 3151 079 031	KZI-6	621.005/106-107 für Nebenantrieb / for PTO	(82)
1922 656.005 656.009 656.008 656.006 1922 AK 656.307 656.306 1922 K 656.106/107 1922 S 656.101/102	05.89 - 08.94	OM441	 3400 123 001	430 10 MFZ430	656.106-107/306-307/005-006/008-009/101	
	08.89 - 08.94		 3482 081 232	430WGTZ		
	05.89 - 08.94		 1878 080 031	KZISZ-5		
	05.89 - 08.94		 3151 000 549	400 10 400GTZ		656.106-107/306-307/005-006/008-009/101
1922 AK 621.306/307	10.81 - 03.91	OM421	 1882 302 131	380 GF380	-> Chass. 234953	
			 1878 000 105	380 10 380GTZ	-> Chass. 234953	
			 3151 000 375	KZIS-4	-> Chass. 234953	
			 3482 124 541	430 GMF430	Chass. 234954->	
			 1882 301 238 ●#	420 GF420	Chass. 234954->	
			 1878 002 706	420 10 420GTZ	Chass. 234954->	
			 3151 000 375	KZIS-4	Chass. 234954->	
			 1861 643 134 #	420 10 420GSZ	für Nebenantrieb / for PTO	(82)
 3151 079 031	KZI-6	für Nebenantrieb / for PTO	(82)			
1922 K 621.107 621.106	10.81 - 03.91	OM421	 1882 302 131	380 GF380	-> Chass. 234953 621.106-107	
			 1878 000 105	380 10 380GTZ	-> Chass. 234953 621.106-107	
			 3151 000 375	KZIS-4	-> Chass. 234953 621.106-107	
			 3482 124 541	430 GMF430	Chass. 234954-> 621.106-107	
			 1882 301 238 ●#	420 GF420	Chass. 234954-> 621.106-107	
			 1878 002 706	420 10 420GTZ	Chass. 234954-> 621.106-107	
			 3151 000 375	KZIS-4	Chass. 234954-> 621.106-107	
			 1861 643 134 #	420 10 420GSZ	621.005/106-107 für Nebenantrieb / for PTO	(82)
 3151 079 031	KZI-6	621.005/106-107				





















		CODE				
--	--	------	--	---	---	---

MERCEDES-BENZ











1922						
1922 S 621.102 621.101	10.81 - 03.91	OM421	 1882 302 131	380 GF380	->Chass. 234953	
			 1878 000 105	380 10 380GTZ	->Chass. 234953	
			 3151 000 375	KZIS-4	->Chass. 234953	
			 3482 124 541	430 GMF430	Chass. 234954->	
			 1882 301 238 ●#	420 GF420	Chass. 234954->	
			 1878 002 706	420 10 420GTZ	Chass. 234954->	
			 3151 000 375	KZIS-4	Chass. 234954->	
1923						
L 1923 LA 1923 LP 1923			 1882 166 737	380 GF380		
			 1878 000 104	380 10 380GTZ		
1924						
1924 336 336, 346			 1882 166 737	380 GF380	354.052-053-054-055/062-064 354.052-053-054-055/062-064	
			 1878 000 104	380 10 380GTZ	354.002-006/012-013/015-016 354.002-006/012-013/015-016	
			 3151 000 529	KZIS-4	354.002-006/012-013/015-016 354.002-006/012-013/015-016	
L,LA,LP,LS,LK 1924 346.111-114 346.351 346.361 346.352 346.365 346.311-314 346.324 346.323 346.362 346.355 LAK,LAS,LPS 1924 346.324 346.362 346.323 346.111-114 346.355 346.351 346.361 346.352 346.365 346.311-314		OM355	 1882 166 737	380 GF380	346.351-352/355/361-362/365/111-114/311-314 /323-324	
			 1878 000 104	380 10 380GTZ	346.351-352/355/361-362/365/111-114/311-314 /323-324	
			 3151 000 529	KZIS-4	346.351-352/355/361-362/365/111-114/311-314 /323-324	
L,LK,LS 1924 346.001-004 346.013		OM355	 1882 302 131	380 GF380		
			 1878 000 105	380 10 380GTZ		
			 3151 000 392	KZIS-4		
LP,LPS 1924 336.365 336.352 336.362 336.355			 1882 288 131	380 GF380N	Nebenantriebs-ID / PTO ID: 80,90 (48)	
1926						
1926 652.046		OM442	 3400 124 101	430 10 MFZ430		
			 1878 005 668	430WGTZ KZISZ-5		
1926 652.046		OM442	 1862 268 031	420 10 420GVZ	Nebenantriebs-ID / PTO ID: 4/120 (48)	
			 3151 166 031	KZI-6	Nebenantriebs-ID / PTO ID: 4/120 (48)	
1926 389.018/019 389.016/017	05.74 - 12.80	OM402	 1882 302 131	380 GF380	389.115-116/144/213/012-014/016-019/043-044 /112	
			 1878 000 105	380 10 380GTZ	389.115-116/144/213/012-014/016-019/043-044 /112	
			 3151 000 375	KZIS-4	389.115-116/144/213/012-014/016-019/043-044 /112	
		 1861 643 134 #	420 10 420GSZ	Chass. 4372224-> 389.016-019/043-044 für Nebenantrieb / for PTO (82)		

		CODE				
--	--	------	--	---	---	---

MERCEDES-BENZ



















1926						
1926 A 389.115/116	05.74 - 12.80	OM402.906, OM402.912		1861 643 134 #	420 10 420GSZ	Chass. 4372224-> 389.115-116/144 für Nebenantrieb / for PTO (82)
		OM402		1882 302 131	380 GF380	
				1878 000 105	380 10 380GTZ	
				1878 000 105	380 10 380GTZ	389.115-116/144/213/012-014/016-019/043-044 /112
				3151 000 375	KZIS-4	
1926 AK 389.144	08.73 - 12.80	OM402.906, OM402.912		1861 643 134 #	420 10 420GSZ	Chass. 4372224-> 389.115-116/144
		OM402		1882 302 131	380 GF380	
				1878 000 105	380 10 380GTZ	
				1878 000 105	380 10 380GTZ	389.115-116/144/213/012-014/016-019/043-044 /112
				3151 000 375	KZIS-4	
1926 AS 389.112 1926 S,1926 LS 389.014 389.013 389.012 389.213	05.74 - 12.80	OM402		1882 302 131	380 GF380	
	08.73 - 09.96			1878 000 105	380 10 380GTZ	
				1878 000 105	380 10 380GTZ	389.115-116/144/213/012-014/016-019/043-044 /112
				3151 000 375	KZIS-4	
1926 K 389.043/044	08.73 - 12.80	OM402.906, OM402.912		1861 643 134 #	420 10 420GSZ	Chass. 4372224-> 389.016-019/043-044 für Nebenantrieb / for PTO (82)
		OM402		1882 302 131	380 GF380	
				1878 000 105	380 10 380GTZ	
				1878 000 105	380 10 380GTZ	389.115-116/144/213/012-014/016-019/043-044 /112
				3151 000 375	KZIS-4	
LP 1926 363.030-032 363.040-042 LPS 1926 363.030-032 363.040-042		OM402		1882 166 737	380 GF380	
				1878 000 104	380 10 380GTZ	

1927						
1927 AK 656.307		OM401LA		3400 123 001  3482 081 232  1878 080 031  3151 000 549	430 10 MFZ430 430WGTZ KZISZ-5	

1928						
1928 346.002 346.001 346.003 346.013 346.004				1882 302 131	380 GF380	
				1878 000 105	380 10 380GTZ	
				3151 000 392	KZIS-4	
1928,1928 L 621.017 621.016 621.466 621.066 621.015 621.416	08.73 - 09.96	OM422		1800 125 301  1882 301 239  1878 002 706  3151 000 375	420 10 GF420 420GTZ KZIS-4	621.015-016-017/214-215/066/416/466
				3482 124 534 ●	430 GMF430	621.015-016-017/066/214-215/416/466
		OM422.905, OM422.907, OM422.911, OM422.906, OM422.913		1882 304 237	420 GF420N	621.015-016-017/111-112-113/214-215 für Nebenantrieb / for PTO (82)
				1878 634 014	420 10 420GSZ	621.015-016-017/111-112-113/214-215 für Nebenantrieb / for PTO (82)



































		CODE					
--	--	------	--	--	---	---	---

MERCEDES-BENZ

1928								
1928 A 621.215 621.214	01.80-03.91	OM422		1800 125 301 ⚙️ 1882 301 239 ⚙️ 1878 002 706 ⚙️ 3151 000 375	420 10 GF420 420GTZ KZIS-4	621.015-016-017/214-215/066/416/466		
				3482 124 534 ●	430 GMF430	621.015-016-017/066/214-215/416/466		
	OM422.905, OM422.907, OM422.911, OM422.913		1882 304 237	420 GF420N	621.015-016-017/111-112-113/214-215 für Nebenantrieb / for PTO	(82)		
			1878 003 269	420 10 420GTZ	621.015-016-017/111-112-113/214-215 für Nebenantrieb / for PTO	(82)		
			3151 204 001	KZI-6	621.214 für Nebenantrieb / for PTO mit Schmierrohranschluß / with lubricating pipe coupling	(82) (91)		
1928 AK 621.317 621.316 1928 AS 621.312	01.80-03.91	OM422		1800 125 301 ⚙️ 1882 301 239 ⚙️ 1878 002 706 ⚙️ 3151 000 375	420 10 GF420 420GTZ KZIS-4			
	01.80-03.91	OM422.905, OM422.907, OM422.911, OM422.913		3482 124 534 ●	430 GMF430			
				1882 304 237	420 GF420N	für Nebenantrieb / for PTO	(82)	
				1878 003 269	420 10 420GTZ	für Nebenantrieb / for PTO	(82)	
				3151 204 001	KZI-6	für Nebenantrieb / for PTO mit Schmierrohranschluß / with lubricating pipe coupling	(82) (91)	
1928 K 621.116/117 1928 L,LK,LS 346.031 346.034 346.033 346.043 346.032	01.80-03.91	OM422		1800 125 301 ⚙️ 1882 301 239 ⚙️ 1878 002 706 ⚙️ 3151 000 375	420 10 GF420 420GTZ KZIS-4			
				3482 124 534 ●	430 GMF430			
					1861 643 134 #	420 10 420GSZ	621.116 für Nebenantrieb / for PTO	(82)
					3151 204 001	KZI-6	621.116 für Nebenantrieb / for PTO mit Schmierrohranschluß / with lubricating pipe coupling	(82) (91)
1928 S,1928 LS 621.111-113 621.163 621.562 621.162 621.511/512	08.73-09.96	OM422		1800 125 301 ⚙️ 1882 301 239 ⚙️ 1878 002 706 ⚙️ 3151 000 375	420 10 GF420 420GTZ KZIS-4	621.111-112-113/162-163/511-512/562		
				3482 124 534 ●	430 GMF430	621.111-112-113/162-163/511-512/562		
	OM422.911, OM422.906		1882 304 237	420 GF420N	621.015-016-017/111-112-113 für Nebenantrieb / for PTO	(82)		
			1878 003 269	420 10 420GTZ	621.015-016-017/111-112-113 für Nebenantrieb / for PTO	(82)		
			3151 204 001	KZI-6	621.111 für Nebenantrieb / for PTO mit Schmierrohranschluß / with lubricating pipe coupling	(82) (91)		











































		CODE				
--	--	------	--	---	---	---

MERCEDES-BENZ

1929								
1929,1929 L 656.015 656.018 656.016 656.416	07.87 - 09.96	OM442	 3400 124 101  3482 081 232  1878 005 668  3151 000 549	430 10 MFZ430 430WGTZ KZISZ-5	656.416			
			 3400 122 501  3482 081 232  1878 634 027  3151 000 278	430 10 MFZ430 430WGTZ KZISZ-5	656.015-016/018/112-113/116-117/416			
		OM442.925, OM442.906, OM442.908, OM442.923, OM442.916, OM442.907	 1888 063 137	380 GF2/380N	656.214-215/317/015-016/018/112/116-117 für Nebenantrieb / for PTO enthält eine Kupplungsscheibe / This part number includes one clutch disc	(82) (66)		
		 1862 304 033 ▽	380 10 380GV	656.214-215/317/015-016/018/112/116-117 für Nebenantrieb / for PTO Lose Kupplungsscheibe / Loose clutch disc	(82) (39)			
		 3151 166 031	KZI-6	656.214-215/317/015-016/018/112/116-117 für Nebenantrieb / for PTO	(82)			
		 1882 019 133	380 GF2/380N	656.214-215/317/015-016/018/112/116-117 In 1888 enthalten / Contained in 1888	(29)			
		 1859 250 101	380 GF2/380	656.214-215/317/015-016/018/112/116-117 In 1888 enthalten / Contained in 1888	(29)			
		 1862 305 033 △	380 10 380GVZ	656.214-215/317/015-016/018/112/116-117 In 1888 enthalten / Contained in 1888	(29)			
1929 A 656.215 656.214 1929 A 656.215 1929 A 656.215	07.88 - 08.94	OM422, 442	 3400 124 101  3482 081 232  1878 005 668  3151 000 549	430 10 MFZ430 430WGTZ KZISZ-5	656.214-215			
	07.88 - 09.93		 1888 063 137	380 GF2/380N	656.214-215/317/015-016/018/112/116-117 für Nebenantrieb / for PTO enthält eine Kupplungsscheibe / This part number includes one clutch disc	(82) (66)		
	07.88 - 08.94		OM443.940, OM442.906, OM442.909, OM442.907, OM442.924	 1862 304 033 ▽	380 10 380GV	656.214-215/317/015-016/018/112/116-117 für Nebenantrieb / for PTO Lose Kupplungsscheibe / Loose clutch disc	(82) (39)	
			 3151 166 031	KZI-6	656.214-215/317/015-016/018/112/116-117 für Nebenantrieb / for PTO	(82)		
			 1882 019 133	380 GF2/380N	656.214-215/317/015-016/018/112/116-117 In 1888 enthalten / Contained in 1888	(29)		
			 1859 250 101	380 GF2/380	656.214-215/317/015-016/018/112/116-117 In 1888 enthalten / Contained in 1888	(29)		
 1862 305 033 △	380 10 380GVZ	656.214-215/317/015-016/018/112/116-117 In 1888 enthalten / Contained in 1888	(29)					
1929 AK 656.316/317	07.88 - 08.94	OM442, 443A	 3400 124 101  3482 081 232  1878 005 668  3151 000 549	430 10 MFZ430 430WGTZ KZISZ-5				
			 1888 055 247	380 GF2/380	656.317 enthält eine Kupplungsscheibe / This part number includes one clutch disc Sonderausführung / Special design	(66) (56)		
			 1862 123 131 ▽	380 10 380GV	656.317 Sonderausführung / Special design	(56)		
			 3151 108 031	KZI-4,5	656.317 Sonderausführung / Special design	(56)		
			 1882 349 003	380 GF2/380	656.317 In 1888 enthalten / Contained in 1888 Sonderausführung / Special design	(29) (56)		
			 1859 250 100	380 GF2/380	656.317 In 1888 enthalten / Contained in 1888 Sonderausführung / Special design	(29) (56)		
			 1862 122 132 △	380 10 380GVZ	656.317 In 1888 enthalten / Contained in 1888 Sonderausführung / Special design	(29) (56)		



		CODE					
--	--	------	--	--	---	---	---











MERCEDES-BENZ

















1929							
1929 AS 656.112 656.312 1929 S 656.113 656.112	07.88 - 08.94	OM442		3400 124 101  3482 081 232  1878 005 668  3151 000 549	430 10 MFZ430 430WGTZ KZISZ-5	656.112-113/312	
	07.88 - 08.94			3400 122 501  3482 081 232  1878 634 027  3151 000 278	430 10 MFZ430 430WGTZ KZISZ-5	656.015-016/018/112-113	
				1888 063 137	380 GF2/380N	656.214-215/317/015-016/018/112/116-117 für Nebenantrieb / for PTO enthält eine Kupplungsscheibe / This part number includes one clutch disc	(82) (66)
				1862 304 033 ▽	380 10 380GV	656.214-215/317/015-016/018/112/116-117 für Nebenantrieb / for PTO Lose Kupplungsscheibe / Loose clutch disc	(82) (39)
				3151 166 031	KZI-6	656.214-215/317/015-016/018/112/116-117 für Nebenantrieb / for PTO	(82)
				1882 019 133	380 GF2/380N	656.214-215/317/015-016/018/112/116-117 In 1888 enthalten / Contained in 1888	(29)
				1859 250 101	380 GF2/380	656.214-215/317/015-016/018/112/116-117 In 1888 enthalten / Contained in 1888	(29)
				1862 305 033 △	380 10 380GVZ	656.214-215/317/015-016/018/112/116-117 In 1888 enthalten / Contained in 1888	(29)
1929 K 656.116/117	07.88 - 08.94	OM442		3400 124 101  3482 081 232  1878 005 668  3151 000 549	430 10 MFZ430 430WGTZ KZISZ-5	656.116-117	
				3400 122 501  3482 081 232  1878 634 027  3151 000 278	430 10 MFZ430 430WGTZ KZISZ-5	656.116-117/416	
				1888 063 137	380 GF2/380N	656.214-215/317/015-016/018/112/116-117 für Nebenantrieb / for PTO enthält eine Kupplungsscheibe / This part number includes one clutch disc	(82) (66)
				1862 304 033 ▽	380 10 380GV	656.214-215/317/015-016/018/112/116-117 für Nebenantrieb / for PTO Lose Kupplungsscheibe / Loose clutch disc	(82) (39)
				3151 166 031	KZI-6	656.214-215/317/015-016/018/112/116-117 für Nebenantrieb / for PTO	(82)
				1882 019 133	380 GF2/380N	656.214-215/317/015-016/018/112/116-117 In 1888 enthalten / Contained in 1888	(29)
				1859 250 101	380 GF2/380	656.214-215/317/015-016/018/112/116-117 In 1888 enthalten / Contained in 1888	(29)
				1862 305 033 △	380 10 380GVZ	656.214-215/317/015-016/018/112/116-117 In 1888 enthalten / Contained in 1888	(29)
1932							
1932 389.02 389.05		OM423		3482 124 522	430 GMF430		
				1878 002 706	420 10 420GTZ		
1932 389.027 389.026 1932 A 389.125 1932 AS 389.124 389.122 1932 S,1932 LS 389.022 389.024 389.023 389.223	05.74 - 03.83	OM403		1800 125 301  1882 301 239  1878 002 706  3151 000 375	420 10 GF420 420GTZ KZIS-4	389.124-125/154/223/022-024/026-027/053-054 /122	
	05.74 - 03.83			3482 124 534 ●	430 GMF430	389.124-125/154/223/022-024/026-027/053-054 /122	
	05.74 - 12.82						
1932 AK 389.154 1932 K 389.053/054	08.73 - 09.96	OM403		1800 125 301  1882 301 239  1878 002 706  3151 000 375	420 10 GF420 420GTZ KZIS-4	389.124-125/154/223/022-024/026-027/053-054 /122	
	08.73 - 08.82			3482 124 534 ●	430 GMF430	389.124-125/154/223/022-024/026-027/053-054 /122	
				1882 304 237	420 GF420N	für Nebenantrieb / for PTO	(82)
				1878 634 014	420 10 420GSZ	für Nebenantrieb / for PTO	(82)

		CODE				
--	--	------	--	---	---	---

MERCEDES-BENZ

































1932						
LP 1932 363.080-082 363.090-092 LPS 1932 363.090-092 363.080-082		OM403		3482 124 534	430 GMF430	
				1882 301 239 ●	420 GF420	
				1861 410 047 #	420 10 420/ 210GSZ	

1933						
1933 621.047 621.096/097 621.046	11.80 - 03.91	OM422A, 423		1882 342 134	420 GF420X	621.046-047/096-097
				1878 002 878	420 10 420GTZ	621.046-047/096-097
				3151 110 031	KZI-4,5	621.046-047/096-097
				1882 346 131 #	420 GF420XN	621.046-047/142-143 für Nebenantrieb / for PTO (82)
				1878 002 706	420 10 420GTZ	621.046-047/142-143 für Nebenantrieb / for PTO (82)
1933 S, 1933 LS 621.143 621.192 621.592 621.142 621.542/543	08.73 - 09.96	OM422A, 423		1882 342 134	420 GF420X	621.142-143/192/542-543/592
				1878 002 878	420 10 420GTZ	621.142-143/192/542-543/592
				3151 110 031	KZI-4,5	621.142-143/192/542-543/592
				1882 346 131 #	420 GF420XN	621.046-047/142-143 für Nebenantrieb / for PTO (82)
				1878 002 706	420 10 420GTZ	621.046-047/142-143 für Nebenantrieb / for PTO (82)

1935								
1935 656.215		OM442		3482 081 231	430 MFZ430			
				1878 005 668	430 10 430WGTZ			
				3151 000 549	KZISZ-5			
1935 646.025 646.077 646.026/027 646.076 1935 AK 646.322 646.327	02.86 - 09.89	OM422A, 442A		1888 055 041	380 GF2/380	646.322/327/025-027/076-077 enthält eine Kupplungsscheibe / This part number includes one clutch disc (66)		
				1862 135 035 ▽	380 10 380GS	646.322/327/025-027/076-077 Lose Kupplungsscheibe / Loose clutch disc (39)		
				3151 108 031	KZI-4,5	646.322/327/025-027/076-077		
	09.87 - 03.91				1882 349 003	380 GF2/380	646.322/327/025-027/076-077 In 1888 enthalten / Contained in 1888 (29)	
					1859 250 100	380 GF2/380	646.322/327/025-027/076-077 In 1888 enthalten / Contained in 1888 (29)	
					1862 138 032 △	380 10 380GSZ	646.322/327/025-027/076-077 In 1888 enthalten / Contained in 1888 (29)	
1935 656.024 656.028 656.076 656.078 656.026 656.025 656.074 656.215	05.89 - 08.94	OM442A		3400 122 601 ● 3482 081 231 ● 1878 080 037 ● 3151 000 278	430 10 MFZ430 430WGTZ KZISZ-5	656.024-026/028/074/076/078		
				1888 063 137	380 GF2/380N	656.172/215/327/025-026/028/122-123 für Nebenantrieb / for PTO enthält eine Kupplungsscheibe / This part number includes one clutch disc (82) (66)		
						1862 304 033 ▽	380 10 380GV	656.172/215/327/025-026/028/122-123 für Nebenantrieb / for PTO Lose Kupplungsscheibe / Loose clutch disc (82) (39)
						3151 166 031	KZI-6	656.172/215/327/025-026/028/122-123 für Nebenantrieb / for PTO (82)
						1882 019 133	380 GF2/380N	656.172/215/327/025-026/028/122-123 In 1888 enthalten / Contained in 1888 (29)
						1859 250 101	380 GF2/380	656.172/215/327/025-026/028/122-123 In 1888 enthalten / Contained in 1888 (29)
						1862 305 033 △	380 10 380GVZ	656.172/215/327/025-026/028/122-123 In 1888 enthalten / Contained in 1888 (29)































		CODE				
--	--	------	--	---	---	---

MERCEDES-BENZ

1935						
1935 AK 656.327 656.327.11	05.89 - 08.94	OM442A	 3400 122 601  3482 081 231  1878 080 037  3151 000 278	430 10 MFZ430 430WGTZ KZISZ-5	656.127/322/327	
		OM442.966, OM442.971, OM442.972, OM442.978, OM442.942	 1888 063 137	380 GF2/380N	656.172/215/327/025-026/028/122-123 für Nebenantrieb / for PTO enthält eine Kupplungsscheibe / This part number includes one clutch disc	(82) (66)
		 1862 304 033 ▽	380 10 380GV	656.172/215/327/025-026/028/122-123 für Nebenantrieb / for PTO Lose Kupplungsscheibe / Loose clutch disc	(82) (39)	
		 3151 166 031	KZI-6	656.172/215/327/025-026/028/122-123 für Nebenantrieb / for PTO	(82)	
		 1882 019 133	380 GF2/380N	656.172/215/327/025-026/028/122-123 In 1888 enthalten / Contained in 1888	(29)	
		 1859 250 101	380 GF2/380	656.172/215/327/025-026/028/122-123 In 1888 enthalten / Contained in 1888	(29)	
		 1862 305 033 △	380 10 380GVZ	656.172/215/327/025-026/028/122-123 In 1888 enthalten / Contained in 1888	(29)	
1935 AS 656.322 1935 K 656.127	05.89 - 08.94	OM442A	 3400 122 601  3482 081 231  1878 080 037  3151 000 278	430 10 MFZ430 430WGTZ KZISZ-5	656.127/322/327	
1935 S 656.122/123 656.172	05.89 - 08.94	OM442A	 3400 122 601  3482 081 231  1878 080 037  3151 000 278	430 10 MFZ430 430WGTZ KZISZ-5	656.122-123/172	
		OM442.976, OM442.963, OM442.944, OM442.943	 1888 063 137	380 GF2/380N	656.172/215/327/025-026/028/122-123 für Nebenantrieb / for PTO enthält eine Kupplungsscheibe / This part number includes one clutch disc	(82) (66)
		 1862 304 033 ▽	380 10 380GV	656.172/215/327/025-026/028/122-123 für Nebenantrieb / for PTO Lose Kupplungsscheibe / Loose clutch disc	(82) (39)	
		 3151 166 031	KZI-6	656.172/215/327/025-026/028/122-123 für Nebenantrieb / for PTO	(82)	
		 1882 019 133	380 GF2/380N	656.172/215/327/025-026/028/122-123 In 1888 enthalten / Contained in 1888	(29)	
		 1859 250 101	380 GF2/380	656.172/215/327/025-026/028/122-123 In 1888 enthalten / Contained in 1888	(29)	
		 1862 305 033 △	380 10 380GVZ	656.172/215/327/025-026/028/122-123 In 1888 enthalten / Contained in 1888	(29)	
		1935 S,1935 LS 646.121 646.123 646.522/523 646.122 646.573 646.172 646.572	08.73 - 09.96	OM422A	 1888 055 041	380 GF2/380
 1862 135 035 ▽	380 10 380GS	646.522-523/572-573 Lose Kupplungsscheibe / Loose clutch disc	(39)			
 3151 108 031	KZI-4,5	646.121-122-123/172/522-523/572-573				
 1882 349 003	380 GF2/380	646.522-523/572-573 In 1888 enthalten / Contained in 1888	(29)			
 1859 250 100	380 GF2/380	646.522-523/572-573 In 1888 enthalten / Contained in 1888	(29)			
 1862 138 032 △	380 10 380GSZ	646.522-523/572-573 In 1888 enthalten / Contained in 1888	(29)			
 1888 063 137	380 GF2/380N	646.122 für Nebenantrieb / for PTO enthält eine Kupplungsscheibe / This part number includes one clutch disc	(82) (66)			
 1862 304 033	380 10 380GV	646.122 für Nebenantrieb / for PTO	(82)			
 3151 204 001	KZI-6	646.122 für Nebenantrieb / for PTO mit Schmierrohranschluß / with lubricating pipe coupling	(82) (91)			







		CODE				
--	--	------	--	---	---	---













MERCEDES-BENZ













1936							
1936 621.025/026 621.075	10.81 - 03.91	OM422A, 423	 1882 342 134	420 GF420X	621.025-026/075		
			 1878 002 878	420 10 420GTZ	621.025-026/075		
			 3151 110 031	KZI-4,5	621.025-026/075		
			 1882 346 131 #	420 GF420XN	621.025-026 für Nebenantrieb / for PTO	(82)	
			 1878 002 706	420 10 420GTZ	621.025-026 für Nebenantrieb / for PTO	(82)	
			 3151 204 001	KZI-6	621.025 für Nebenantrieb / for PTO mit Schmierrohranschluß / with lubricating pipe coupling	(82) (91)	
1936 AK 621.327 1936 AS 621.322 1936 K 621.127	10.81 - 03.91	OM422A, 423	 1882 342 134	420 GF420X			
	10.81 - 03.91		 1878 002 878	420 10 420GTZ			
	10.81 - 03.91		 3151 110 031	KZI-4,5			
			 1882 346 131 #	420 GF420XN	für Nebenantrieb / for PTO	(82)	
			 1878 002 706	420 10 420GTZ	für Nebenantrieb / for PTO	(82)	
			 3151 204 001	KZI-6	für Nebenantrieb / for PTO mit Schmierrohranschluß / with lubricating pipe coupling	(82) (91)	
		OM423	 1888 042 009	380 GF2/380	enthält eine Kupplungsscheibe / This part number includes one clutch disc	(66)	
			 1878 000 968 ▽	380 10 380GTZ	Lose Kupplungsscheibe / Loose clutch disc	(39)	
			 3151 108 031	KZI-4,5			
			 1882 341 001	380 GF2/380	In 1888 enthalten / Contained in 1888	(29)	
			 1859 250 102	380 GF2/380	In 1888 enthalten / Contained in 1888	(29)	
			 1878 000 968 △	380 10 380GTZ	In 1888 enthalten / Contained in 1888	(29)	
1936 S,1936 LS 621.123 621.522 621.122	08.73 - 09.96	OM422A, 423	 1882 342 134	420 GF420X	621.122-123/522		
			 1878 002 878	420 10 420GTZ	621.122-123/522		
			 3151 110 031	KZI-4,5	621.122-123/522		
			 1882 346 131 #	420 GF420XN	621.122-123 für Nebenantrieb / for PTO	(82)	
			 1878 002 706	420 10 420GTZ	621.122-123 für Nebenantrieb / for PTO	(82)	
			 3151 204 001	KZI-6	621.122-123 für Nebenantrieb / for PTO mit Schmierrohranschluß / with lubricating pipe coupling	(82) (91)	
			OM423	 1888 042 009	380 GF2/380	621.122-123 enthält eine Kupplungsscheibe / This part number includes one clutch disc	(66)
				 1878 000 968 ▽	380 10 380GTZ	621.122-123 Lose Kupplungsscheibe / Loose clutch disc	(39)
				 3151 108 031	KZI-4,5	621.122-123	
				 1882 341 001	380 GF2/380	621.122-123 In 1888 enthalten / Contained in 1888	(29)
				 1859 250 102	380 GF2/380	621.122-123 In 1888 enthalten / Contained in 1888	(29)
				 1878 000 968 △	380 10 380GTZ	621.122-123 In 1888 enthalten / Contained in 1888	(29)

		CODE					
--	--	------	--	--	---	---	---

MERCEDES-BENZ

























1938							
1938 621.086 621.085 1938 S,1938 LS 621.583 621.582 621.182	11.80 - 06.90	OM422LA		1888 042 009	380 GF2/380	621.085-086/182/582-583 enthält eine Kupplungsscheibe / This part number includes one clutch disc	(66)
	08.73 - 09.96			1878 000 968 ▽	380 10 380GTZ	621.085-086/182/582-583 Lose Kupplungsscheibe / Loose clutch disc	(39)
				3151 108 031	KZI-4,5	621.085-086/182/582-583	
				1882 341 001	380 GF2/380	621.085-086/182/582-583 In 1888 enthalten / Contained in 1888	(29)
				1859 250 102	380 GF2/380	621.085-086/182/582-583 In 1888 enthalten / Contained in 1888	(29)
				1878 000 968 △	380 10 380GTZ	621.085-086/182/582-583 In 1888 enthalten / Contained in 1888	(29)

1944							
1944 646.095/096	10.85 - 12.89	OM442LA		1888 055 247	380 GF2/380	646.095-096/192-193 enthält eine Kupplungsscheibe / This part number includes one clutch disc	(66)
				1862 123 131 ▽	380 10 380GV	646.095-096/192-193 Lose Kupplungsscheibe / Loose clutch disc	(39)
				3151 108 031	KZI-4,5	646.095-096/192-193	
				1882 349 003	380 GF2/380	646.095-096/192-193 In 1888 enthalten / Contained in 1888	(29)
				1859 250 100	380 GF2/380	646.095-096/192-193 In 1888 enthalten / Contained in 1888	(29)
				1862 122 132 △	380 10 380GVZ	646.095-096/192-193 In 1888 enthalten / Contained in 1888	(29)
1944 S,1944 LS 646.193 646.593 646.192 646.592	08.73 - 09.96	OM442LA		1888 055 247	380 GF2/380	646.095-096/192-193/592-593 enthält eine Kupplungsscheibe / This part number includes one clutch disc	(66)
				1862 123 131 ▽	380 10 380GV	646.592-593 Lose Kupplungsscheibe / Loose clutch disc	(39)
				3151 108 031	KZI-4,5	646.095-096/192-193/592-593	
				1882 349 003	380 GF2/380	646.592-593 In 1888 enthalten / Contained in 1888	(29)
				1859 250 100	380 GF2/380	646.592-593 In 1888 enthalten / Contained in 1888	(29)
				1862 122 132 △	380 10 380GVZ	646.592-593 In 1888 enthalten / Contained in 1888	(29)

1945								
1945 AK 656.317	07.88 - 08.94	OM442, 443A		3400 124 101 ● 3482 081 232 ● 1878 005 668 ● 3151 000 549	430 10 MFZ430 430WGTZ KZISZ-5			
			OM443A		1888 055 247	380 GF2/380	enthält eine Kupplungsscheibe / This part number includes one clutch disc Sonderausführung / Special design	(66) (56)
					1862 123 131 ▽	380 10 380GV	Lose Kupplungsscheibe / Loose clutch disc Sonderausführung / Special design	(39) (56)
				3151 108 031	KZI-4,5	Sonderausführung / Special design	(56)	
				1882 349 003	380 GF2/380	In 1888 enthalten / Contained in 1888 Sonderausführung / Special design	(29) (56)	
				1859 250 100	380 GF2/380	In 1888 enthalten / Contained in 1888 Sonderausführung / Special design	(29) (56)	
				1862 122 132 △	380 10 380GVZ	In 1888 enthalten / Contained in 1888 Sonderausführung / Special design	(29) (56)	
		OM443.940		1888 063 137	380 GF2/380N	Nebenantriebs-ID / PTO ID: 4/125 enthält eine Kupplungsscheibe / This part number includes one clutch disc	(48) (66)	
				1862 304 033 ▽	380 10 380GV	Nebenantriebs-ID / PTO ID: 4/125 Lose Kupplungsscheibe / Loose clutch disc	(48) (39)	
				3151 166 031	KZI-6	Nebenantriebs-ID / PTO ID: 4/125	(48)	
				1882 019 133	380 GF2/380N	In 1888 enthalten / Contained in 1888	(29)	
				1859 250 101	380 GF2/380	In 1888 enthalten / Contained in 1888	(29)	
				1862 305 033 △	380 10 380GVZ	In 1888 enthalten / Contained in 1888	(29)	



		CODE					
--	--	------	--	--	---	---	---



MERCEDES-BENZ























1948								
1948 656.317 656.215				1888 063 137	380 GF2/380N	Nebenantriebs-ID / PTO ID: 4/125 enthält eine Kupplungsscheibe / This part number includes one clutch disc	(48) (66)	
				1862 304 033 ▽	380 10 380GV	Nebenantriebs-ID / PTO ID: 4/125 Lose Kupplungsscheibe / Loose clutch disc	(48) (39)	
				3151 166 031	KZI-6	Nebenantriebs-ID / PTO ID: 4/125	(48)	
				1882 019 133	380 GF2/380N	In 1888 enthalten / Contained in 1888	(29)	
				1859 250 101	380 GF2/380	In 1888 enthalten / Contained in 1888	(29)	
				1862 305 033 △	380 10 380GVZ	In 1888 enthalten / Contained in 1888	(29)	
1948 656.095 656.094 656.096	09.88 - 07.92	OM442		3400 121 601 • 3488 017 432 • 1878 634 022 • 3151 000 547	400 10 MFZ2/400X 400GVZ KZISZ-5	->Chass. K011863		
				3400 122 901 • 3482 081 233 • 1878 002 735 • 3151 000 278	430 10 MFZ430 430GTZ KZISZ-5	Chass. K011863->		
		OM442LA		3488 017 432	400 MFZ2/400X	für OE-Nummer / for OE number 005 250 88 04 für OE-Nummer / for OE number 005 250 76 04 für OE-Nummer / for OE number 005 250 77 04 enthält eine Kupplungsscheibe / This part number includes one clutch disc Sonderausführung / Special design	(83) (83) (83) (66)	
				1878 634 022 #	400 10 400GVZ	für OE-Nummer / for OE number 014 250 70 03 für OE-Nummer / for OE number 014 250 08 03 Sonderausführung / Special design	(83) (83) (56)	
				1878 005 805	400 10 400GTZ	für OE-Nummer / for OE number 014 250 70 03 für OE-Nummer / for OE number 014 250 08 03 Sonderausführung / Special design	(83) (83) (56)	
				3151 000 547	KZISZ-5	für OE-Nummer / for OE number 002 250 08 15 für OE-Nummer / for OE number 001 250 88 15 für OE-Nummer / for OE number 001 250 80 15 Sonderausführung / Special design	(83) (83) (83) (56)	
	1948 AK 656.317		OM442		1888 055 247	380 GF2/380	enthält eine Kupplungsscheibe / This part number includes one clutch disc Sonderausführung / Special design	(66) (56)
					1862 123 131 ▽	380 10 380GV	Lose Kupplungsscheibe / Loose clutch disc Sonderausführung / Special design	(39) (56)
					3151 108 031	KZI-4,5	Sonderausführung / Special design	(56)
					1882 349 003	380 GF2/380	In 1888 enthalten / Contained in 1888 Sonderausführung / Special design	(29) (56)
				1859 250 100	380 GF2/380	In 1888 enthalten / Contained in 1888 Sonderausführung / Special design	(29) (56)	
				1862 122 132 △	380 10 380GVZ	Sonderausführung / Special design	(56)	
1953								
1953 655.593		OM442		3400 121 601 • 3488 017 432 • 1878 634 022 • 3151 000 547	400 10 MFZ2/400X 400GVZ KZISZ-5	für Ausrückgabel mit Rollen / for release fork with rollers	(70)	
2020								
2020 L 677.224 677.233	01.84 - 12.98	OM366LA		3482 051 131 #	350 GMF350X	677.224/233		
				1878 001 070	350 10 350GTZ	677.224/233		
				3151 000 374	KZIS-4	677.224/233		
L,LA,LB,LAB 2220 345.		OM344		1882 166 737	380 GF380			
				1878 000 104	380 10 380GTZ			
				3151 000 529	KZIS-4			



		CODE				
--	--	------	--	---	---	---



MERCEDES-BENZ

2020						
LPS 2020			 1882 166 737	380		
				GF380		
			 1878 000 104	380 10		
			 3151 000 529	KZIS-4		

2023						
LPS 2023			 1882 166 737	380		
				GF380		
			 1878 000 104	380 10		
			 3151 000 529	KZIS-4		











































2024								
2024 336			 1882 166 737	380				
				GF380				
			 1878 000 104	380 10				
			 3151 000 529	KZIS-4				
2024 656.046 656.048/049 656.045 2024 656.045 656.048 656.046 656.049 2024 AK 656.309 656.307 2024 AK 656.309 2024 K 656.109 2024 K 656.109	02.93 - 09.96	OM401LA	 3400 700 411	430 10	656.109/309/045-046/048-049			
			 3482 081 232	MFZ430				
	01.94 - 09.96		 1878 080 033	430WGTZ				
			 3151 000 278	KZISZ-5				
	02.93 - 09.96	OM401.975, OM445.924, OM401.984, OM445.925	 1888 063 137	380			Nebenantriebs-ID / PTO ID: 4	(48)
				GF2/380N			enthält eine Kupplungsscheibe / This part number includes one clutch disc	(66)
	01.94 - 09.96		 1862 304 033 ▽	380 10			Nebenantriebs-ID / PTO ID: 4	(48)
				380GV			Loose Kupplungsscheibe / Loose clutch disc	(39)
			 3151 166 031	KZI-6			Nebenantriebs-ID / PTO ID: 4	(48)
			 1882 019 133	380			In 1888 enthalten / Contained in 1888	(29)
		 1859 250 101	380	In 1888 enthalten / Contained in 1888	(29)			
		 1862 305 033 △	380 10	In 1888 enthalten / Contained in 1888	(29)			
			380GVZ					
2024 AK 656.307		OM401LA	 3400 123 001	430 10				
			 3482 081 232	MFZ430				
			 1878 080 031	430WGTZ				
			 3151 000 549	KZISZ-5				
2024 L 679.223 679.227	01.84 - 12.98	OM366LA	 1882 166 737	380	679.223/227			
				GF380				
			 1878 000 105	380 10				
			 3151 000 374	KZIS-4	679.223/227			
LPS 2024 366.356 366.366		OM355	 1882 166 737	380				
				GF380				
			 1878 000 104	380 10				
			 3151 000 529	KZIS-4				

2025						
2025 S 619.211	08.83 - 03.91	OM422	 1882 302 135 #	380		
				GF380		
			 1878 000 105	380 10		
			 3151 000 375	KZIS-4		









2026						
2026 S 391.310	10.76 - 10.80	OM402	 1882 302 131	380		
				GF380		
			 1878 000 105	380 10		
			 3151 000 375	KZIS-4		









		CODE				
--	--	------	--	---	---	---







MERCEDES-BENZ







2027							
2027 AK 656.309	02.93 - 09.96	OM401LA		3400 700 411  3482 081 232  1878 080 033  3151 000 278	430 10 MFZ430 430WGTZ KZISZ-5		
2028							
2028 A 624.202/203 624.304	01.80 - 06.89	OM422		1800 125 301  1882 301 239  1878 002 706  3151 000 375	420 10 GF420 420GTZ KZIS-4	624.202-203/304	
				3482 124 534 ●	430 GMF430	624.202-203/304	
		OM422.907, OM422.911, OM422.913, OM422.916		1882 304 237	420 GF420N	624.304 Nebenantriebs-ID / PTO ID: 110	(48)
			1878 634 014	420 10 420GSZ	624.304 Nebenantriebs-ID / PTO ID: 110	(48)	
2028 LS 622.555 622.505	01.80 - 06.89	OM422		1800 125 301  1882 301 239  1878 002 706  3151 000 375	420 10 GF420 420GTZ KZIS-4		
	3482 124 534 ●	430 GMF430					
2031							
2031 656.214		OM401LA		3400 124 101  3482 081 232  1878 005 668  3151 000 549	430 10 MFZ430 430WGTZ KZISZ-5		
				1888 063 137	380 GF2/380N	Nebenantriebs-ID / PTO ID: 4/125 enthält eine Kupplungsscheibe / This part number includes one clutch disc	(48) (66)
				1862 304 033 ▽	380 10 380GV	Nebenantriebs-ID / PTO ID: 4/125 Lose Kupplungsscheibe / Loose clutch disc	(48) (39)
				3151 166 031	KZI-6	Nebenantriebs-ID / PTO ID: 4/125	(48)
				1882 019 133	380 GF2/380N	In 1888 enthalten / Contained in 1888	(29)
				1859 250 101	380 GF2/380	In 1888 enthalten / Contained in 1888	(29)
				1862 305 033 △	380 10 380GVZ	In 1888 enthalten / Contained in 1888	(29)
2031 656.014 656.012 656.011 2031 A 656.214 656.205 2031 A 656.205 2031 A 656.205 2031 A 656.205 2031 A 656.205 2031 AS 656.302 2031 S 656.142	03.92 - 09.96	OM401LA		3400 124 001  3482 081 231  1878 634 027  3151 000 278	430 10 MFZ430 430WGTZ KZISZ-5	656.147/205/302/011-012/014/142	
	03.92 - 09.96						
	01.94 - 09.96	OM401.979, OM401.986, OM445.930,		1888 063 137	380 GF2/380N	Nebenantriebs-ID / PTO ID: 4/125 enthält eine Kupplungsscheibe / This part number includes one clutch disc	(48) (66)
	03.92 - 09.96	OM446.927, OM402.996,		1862 304 033 ▽	380 10 380GV	Nebenantriebs-ID / PTO ID: 4/125 Lose Kupplungsscheibe / Loose clutch disc	(48) (39)
	01.94 - 09.96	OM440.979, OM402.978,		3151 166 031	KZI-6	Nebenantriebs-ID / PTO ID: 4/125	(48)
	03.92 - 09.96	OM401.972, OM401.993		1882 019 133	380 GF2/380N	In 1888 enthalten / Contained in 1888	(29)
03.92 - 09.96				1859 250 101	380 GF2/380	In 1888 enthalten / Contained in 1888	(29)
03.92 - 09.96				1862 305 033 △	380 10 380GVZ	In 1888 enthalten / Contained in 1888	(29)
2031 K 656.147 2031 K 656.147	03.92 - 09.96	OM401LA		3400 124 001  3482 081 231  1878 634 027  3151 000 278	430 10 MFZ430 430WGTZ KZISZ-5	656.147	
	03.92 - 09.96						
2032							
2032 6x2 391.32		OM423		3482 124 522	430 GMF430		
				1878 002 706	420 10 420GTZ		

MERCEDES-BENZ

2032						
2032 S 391.320	08.75 - 09.83	OM403	 1800 125 301  1882 301 239  1878 002 706  3151 000 375	420 10 GF420 420GTZ KZIS-4		
			 3482 124 534 ●	430 GMF430		
LPS 2032 363.362 363.352		OM403	 3482 124 534	430 GMF430		
			 1882 301 239 ●	420 GF420		
			 1861 410 047 #	420 10 420/ 210GSZ		































2033						
2033 LS 622.570 622.520	12.81 - 05.87	OM422A	 1888 042 009	380 GF2/380	622.570 enthält eine Kupplungsscheibe / This part number includes one clutch disc	(66)
			 1878 000 968 ▽	380 10 380GTZ	622.570 Lose Kupplungsscheibe / Loose clutch disc	(39)
			 3151 108 031	KZI-4,5	622.570	
			 1882 341 001	380 GF2/380	622.570 In 1888 enthalten / Contained in 1888	(29)
			 1878 000 968 △	380 10 380GTZ	622.570 In 1888 enthalten / Contained in 1888	(29)
		OM422A, 423	 1882 342 134	420 GF420X	622.520/570	
			 1878 002 878	420 10 420GTZ	622.520/570	
			 3151 110 031	KZI-4,5	622.520/570	

2035						
2035 S, 2035 LS 647.510 647.110 647.560	08.73 - 09.96	OM422A	 1888 055 041	380 GF2/380	647.510/560/110 625.123 enthält eine Kupplungsscheibe / This part number includes one clutch disc	(66)
			 1862 135 035 ▽	380 10 380GS	647.510/560 625.123 Lose Kupplungsscheibe / Loose clutch disc	(39)
			 3151 108 031	KZI-4,5	647.510/560/110 625.123	
			 1882 349 003	380 GF2/380	647.510/560 625.123 In 1888 enthalten / Contained in 1888	(29)
			 1859 250 100	380 GF2/380	647.510/560 625.123 In 1888 enthalten / Contained in 1888	(29)
			 1862 138 032 △	380 10 380GSZ	647.510/560 625.123 In 1888 enthalten / Contained in 1888	(29)

2036						
2036 A 624.203 624.304	01.80 - 06.89	OM442.950, OM442.962	 1800 125 301  1882 301 239  1878 002 706  3151 000 375	420 10 GF420 420GTZ KZIS-4		
			 1882 342 134	420 GF420X		
2036 LS 622.510	03.84 - 03.91	OM422A, 423	 1878 002 878	420 10 420GTZ		
			 3151 110 031	KZI-4,5		















































		CODE				
--	--	------	--	---	---	---

MERCEDES-BENZ

2038								
2038 656.035 656.038 656.036 656.132 656.086 655.337 656.085 656.088 656.034 2038 656.085 656.088 655.337 656.086	11.91 - 09.96	OM402LA, 442LA, 446		3400 122 601  3482 081 231  1878 080 037  3151 000 278	430 10 MFZ430 430WGTZ KZISZ-5	656.086/088/132/332/034-036/038/085 655.337		
	12.92 -			3400 122 901  3482 081 233  1878 002 735  3151 000 278	430 10 MFZ430 430GTZ KZISZ-5	für / for: SA033617-01 656.086/088/132/332/034-036/038/085 655.337	(68)	
			OM402.971, OM402.985, OM446.925, OM446.927, OM402.986, OM402.996, OM402.972		1888 063 137	380 GF2/380N	655.337 656.086/088/332/035-036/038/085 für Nebenantrieb / for PTO enthält eine Kupplungsscheibe / This part number includes one clutch disc	(82) (66)
					1862 304 033 ▽	380 10 380GV	656.086/088/332/035-036/038/085 655.337 für Nebenantrieb / for PTO Lose Kupplungsscheibe / Loose clutch disc	(82) (39)
					3151 166 031	KZI-6	656.086/088/332/035-036/038/085 655.337 für Nebenantrieb / for PTO	(82)
					1882 019 133	380 GF2/380N	655.337 656.086/088/332/035-036/038/085 In 1888 enthalten / Contained in 1888	(29)
					1859 250 101	380 GF2/380	656.086/088/332/035-036/038/085 655.337 In 1888 enthalten / Contained in 1888	(29)
					1862 305 033 △	380 10 380GVZ	656.086/088/332/035-036/038/085 655.337 In 1888 enthalten / Contained in 1888	(29)
					3483 023 032 ⊕	445 GMFZ445W	655.337 für Fahrzeuge mit Wandlerschaltkupplung / for vehicles with converter and clutch unit	(76)
					1878 003 780	445 24 445GTZ	655.337 für Fahrzeuge mit Wandlerschaltkupplung / for vehicles with converter and clutch unit	(76)
2038 AS 656.332 2038 AS 656.332 2038 AS 656.332 2038 S 656.132	12.92 - 09.96	OM402LA, 442LA, 446		3400 122 601  3482 081 231  1878 080 037  3151 000 278	430 10 MFZ430 430WGTZ KZISZ-5	656.086/088/132/332/034-036/038/085 655.337		
	01.94 - 09.96			3400 122 901  3482 081 233  1878 002 735  3151 000 278	430 10 MFZ430 430GTZ KZISZ-5	für / for: SA033617-01 656.086/088/132/332/034-036/038/085 655.337	(68)	
	12.92 - 09.96		OM402.971, OM440.970, OM402.985, OM446.927, OM440.979, OM402.978		1888 063 137	380 GF2/380N	656.086/088/332/035-036/038/085 655.337 für Nebenantrieb / for PTO enthält eine Kupplungsscheibe / This part number includes one clutch disc	(82) (66)
	11.91 - 09.96				1862 304 033 ▽	380 10 380GV	656.086/088/332/035-036/038/085 655.337 für Nebenantrieb / for PTO Lose Kupplungsscheibe / Loose clutch disc	(82) (39)
					3151 166 031	KZI-6	656.086/088/332/035-036/038/085 655.337 für Nebenantrieb / for PTO	(82)
					1882 019 133	380 GF2/380N	656.086/088/332/035-036/038/085 655.337 In 1888 enthalten / Contained in 1888	(29)
					1859 250 101	380 GF2/380	656.086/088/332/035-036/038/085 655.337 In 1888 enthalten / Contained in 1888	(29)
					1862 305 033 △	380 10 380GVZ	656.086/088/332/035-036/038/085 655.337 In 1888 enthalten / Contained in 1888	(29)

























		CODE					
--	--	------	--	--	---	---	---

MERCEDES-BENZ

2044								
2044 655.337 656.091 656.034 656.190 656.092/093	01.92 - 09.96	OM442LA	 3400 121 601  3488 017 432  1878 634 022  3151 000 547	400 10 MFZ2/400X 400GVZ KZISZ-5	->Chass. K011863 656.091-092-093/190			
			 3400 122 901  3482 081 233  1878 002 735  3151 000 278	430 10 MFZ430 430GTZ KZISZ-5	Chass. K011864-> 656.091-092-093/190			
		OM440.970, OM440.978, OM446.922	 3483 023 032 ⊕	445 GMFZ445W	655.337 für Fahrzeuge mit Wandlerschaltkupplung / for vehicles with converter and clutch unit	(76)		
		 1878 003 780	445 24 445GTZ	655.337 für Fahrzeuge mit Wandlerschaltkupplung / for vehicles with converter and clutch unit	(76)			
2044 AS 656.332	01.94 - 09.96	OM440.970, OM440.979	 1888 063 137	380 GF2/380N	626.332 Nebenantriebs-ID / PTO ID: 4/125 enthält eine Kupplungsscheibe / This part number includes one clutch disc	(48) (66)		
			 1862 304 033 ▽	380 10 380GV	626.332 Nebenantriebs-ID / PTO ID: 4/125 Lose Kupplungsscheibe / Loose clutch disc	(48) (39)		
			 3151 166 031	KZI-6	626.332 Nebenantriebs-ID / PTO ID: 4/125	(48)		
			 1882 019 133	380 GF2/380N	626.332 In 1888 enthalten / Contained in 1888	(29)		
			 1859 250 101	380 GF2/380	626.332 In 1888 enthalten / Contained in 1888	(29)		
			 1862 305 033 △	380 10 380GVZ	626.332 In 1888 enthalten / Contained in 1888	(29)		
2044 S 656.190	01.92 - 09.96	OM442LA	 3400 121 601  3488 017 432  1878 634 022  3151 000 547	400 10 MFZ2/400X 400GVZ KZISZ-5	->Chass. K011863 656.091-092-093/190			
			 3400 122 901  3482 081 233  1878 002 735  3151 000 278	430 10 MFZ430 430GTZ KZISZ-5	Chass. K011864-> 656.091-092-093/190			
2050								
2050 656.096 656.094/095 2050 S 656.192	01.91 - 09.96	OM442	 3400 121 601  3488 017 432  1878 634 022  3151 000 547	400 10 MFZ2/400X 400GVZ KZISZ-5	->Chass. K011863 656.094-095-096/192			
			 3400 122 901  3482 081 233  1878 002 735  3151 000 278	430 10 MFZ430 430GTZ KZISZ-5	Chass. K011864-> 656.094-095-096/192			
	01.91 - 09.96	OM442LA	 3400 121 601  3488 017 432  1878 634 022  3151 000 547	400 10 MFZ2/400X 400GVZ KZISZ-5	für / for: SA33613-03 656.094-095-096/192	(68)		
2219								
2219 385.372 385.377 385.375 385.373 2219 K 385.390/391 2219 KO 385.392	06.76 - 01.87	OM401.925, OM401.914, OM401.926	 3482 051 131 #	350 GMF350X				
			 1878 001 070	350 10 350GTZ				
	06.76 - 01.87			 3151 043 031	KZI-4,5			
				 1882 288 131	380 GF380N	385.079/372-373/375/392 für Nebenantrieb / for PTO	(82)	
				 1878 000 964	380 10 380GTZ	385.079/372-373/375/392 für Nebenantrieb / for PTO	(82)	
2219,2219 L 385.323 385.528 385.078/079 385.325 385.322 385.328 385.523 385.525	08.73 - 09.96	OM362, 366, 401	 3482 051 131 #	350 GMF350X	385.323/325/523/525/528			
			 1878 001 070	350 10 350GTZ	385.323/325/523/525/528			
			 3151 043 031	KZI-4,5	385.323/325/523/525/528			
	06.76 - 01.87	OM401.923, OM401.927, OM401.926		 1882 288 131	380 GF380N	385.079/372-373/375/392 für Nebenantrieb / for PTO	(82)	
				 1878 000 964	380 10 380GTZ	385.079/372-373/375/392 für Nebenantrieb / for PTO	(82)	

		CODE				
--	--	------	--	---	---	---



























MERCEDES-BENZ

2219							
2219 C,2219 CL 619.014 619.203/204 619.012 619.412 619.011 619.411 619.414	08.73 - 09.96	OM362, 366		3482 000 953	350 GMF350X	619.011-012/014/411-412/414/203-204	
				3482 011 331 #	360 GMF360	619.011-012/014/411-412/414/203-204	
				1878 001 070	350 10 350GTZ	619.011-012/014/411-412/414/203-204	
				3482 051 131 ●#	350 GMF350X	619.411-412/414/011-012/014/203-204 Nur zusammen verbauen / Only install together	(51)
				1878 001 144 ●	350 10 350WGTZ	619.411-412/414/011-012/014/203-204 Nur zusammen verbauen / Only install together	(51)
				3151 000 374	KZIS-4	619.011-012/014/411-412/414/203-204	
LP,LPB 2219 355,360				1878 001 074	350 10 350GTZ	Nebenantriebs-ID / PTO ID: 70,80	(48)
LP,LPK 2219 360.355-357 355.451-453 355.461		OM360		1882 234 433	350 GF350		
				1878 001 074	350 10 350GTZ		
				3151 094 041	KZI-4		
2220							
2220,2220 L 619.204 619.402 619.411/412 619.203 619.414 619.012 619.014 619.011	08.73 - 09.96	OM362, 366		3482 000 953	350 GMF350X	619.011-012/014/411-412/414/203-204	
				3482 011 331 #	360 GMF360	619.011-012/014/411-412/414/203-204	
				1878 001 070	350 10 350GTZ	619.011-012/014/411-412/414/203-204	
				3482 051 131 ●#	350 GMF350X	619.411-412/414 Nur zusammen verbauen / Only install together	(51)
				1878 001 144 ●	350 10 350WGTZ	619.411-412/414 Nur zusammen verbauen / Only install together	(51)
				3151 000 374	KZIS-4		
2222							
2222 619.036-038 2222 K 619.137/138	05.82 - 03.91	OM421		1882 302 131	380 GF380	->Chass. 234953	
	05.82 - 03.91			1878 000 105	380 10 380GTZ	->Chass. 234953	
				3151 000 375	KZIS-4	->Chass. 234953	
				3482 124 541	430 GMF430	Chass. 234954->	
				1882 301 238 ●#	420 GF420	Chass. 234954->	
				1878 002 706	420 10 420GTZ	Chass. 234954->	
				3151 000 375	KZIS-4	Chass. 234954->	
				1861 643 134 #	420 10 420GSZ	für Nebenantrieb / for PTO	(82)
				3151 079 031	KZI-6	für Nebenantrieb / for PTO	(82)

		CODE					
--	--	------	--	--	---	---	---

MERCEDES-BENZ

2222

2222,2222 L 619.019 619.017 619.419 619.417 619.208/209	08.73 - 09.96	OM421.905		1800 125 301  1882 301 239  1878 002 706  3151 000 375	420 10 GF420 420GTZ KZIS-4			
		OM421		1882 302 131	380	->Chass. 234953 619.017/019/208-209/417/419		
				1878 000 105	380 10	->Chass. 234953 619.017/019/417/419/208-209		
				3151 126 031	KZI-4,5	->Chass. 234953 619.017/019/417/419/208-209		
				3482 124 541	430	Chass. 234954-> 619.017/019/417/419/208-209		
				1882 301 238 ●#	420	Chass. 234954-> 619.017/019/417/419/208-209		
				1878 002 706	420 10	Chass. 234954-> 619.417/419/208-209/017/019		
				3151 126 031	KZI-4,5	Chass. 234954-> 619.208-209/417/419/017/019		
				1861 643 134 #	420 10	619.208-209 für Nebenantrieb / for PTO		(82)
			3151 079 031	KZI-6	619.208-209 für Nebenantrieb / for PTO		(82)	
		OM441		3482 124 541	430	619.419		
				1882 301 238 ●#	420	619.419		
				1878 002 706	420 10	619.419		
				3151 126 031	KZI-4,5	619.419		
2222 B 619.045 619.047	05.82 - 03.91	OM421		1800 125 301  1882 301 239  1878 002 706  3151 000 375	420 10 GF420 420GTZ KZIS-4	619.045/047		
				3482 124 534 ●	430	619.045/047		
				1882 304 237	420	619.045 für Nebenantrieb / for PTO		(82)
				1861 643 134 #	420 10	619.045 für Nebenantrieb / for PTO		(82)
				3151 079 031	KZI-6	619.045 für Nebenantrieb / for PTO		(82)
				1861 643 134 #	420 10	619.045/047 für Nebenantrieb / for PTO		(82)
	3151 079 031	KZI-6	619.045/047 für Nebenantrieb / for PTO		(82)			

2223

































LP 2223 335.462 335.452		OM355		1882 166 737	380		
				1878 000 104	380 10		
				3151 000 529	KZIS-4		
			1882 288 131	380	Nebenantriebs-ID / PTO ID: 80,90		(48)

2224

2224 385.335 385.338 385.332/333	04.76 - 12.82	OM402		1882 302 131	380	385.332-333/335/338/383/385/387/395/397/399		
				1878 000 105	380 10	385.332-333/335/338/383/385/387/395/397/399		
				3151 000 375	KZIS-4	385.332-333/335/338/383/385/387/395/397/399		
		OM402, 403		1882 302 131	380			
				1878 000 105	380 10			
				3151 000 375	KZIS-4			

		CODE				
--	--	------	--	---	---	---

MERCEDES-BENZ

2224								
2224 385.387 385.383 385.385	04.76 - 12.82	OM402	 1882 302 131	380 GF380	385.332-333/335/338/383/385/387/395/397/399			
			 1878 000 105	380 10 380GTZ	385.332-333/335/338/383/385/387/395/397/399			
			 3151 000 375	KZIS-4	385.332-333/335/338/383/385/387/395/397/399			
		OM402, 403	 1882 302 131	380 GF380				
			 1878 000 105	380 10 380GTZ				
			 3151 000 375	KZIS-4				
		OM402.928, OM402.911	 1861 643 134 #	420 10 420GSZ	385.383/385/387/394/396-398 für Nebenantrieb / for PTO	(82)		
			 3151 079 031	KZI-6	385.383/385/387/394/396-398 für Nebenantrieb / for PTO	(82)		
		2224 B 385.394 385.396 385.398	05.75 - 03.84	OM402	 1882 330 032 #	420 GF420	->08.1976	
 1878 001 136	420 10 420GTZ				->08.1976			
 3151 000 375	KZIS-4				->08.1976			
 3482 124 541	430 GMF430				09.1976->			
 1882 301 238 ●#	420 GF420				09.1976->			
 1878 001 136	420 10 420GTZ				09.1976->			
 3151 000 375	KZIS-4				09.1976->			
OM402.914	 1861 643 134 #			420 10 420GSZ	385.383/385/387/394/396-398 für Nebenantrieb / for PTO	(82)		
	 3151 079 031			KZI-6	385.383/385/387/394/396-398 für Nebenantrieb / for PTO	(82)		
OM403	 1800 125 301			420 10 GF420	385.394/396/398			
	 3482 124 534 ●			430 GMF430	385.394/396/398			
2224 K 385.395 385.397	04.76 - 12.82	OM402	 1882 302 131	380 GF380	385.332-333/335/338/383/385/387/395/397/399			
			 1878 000 105	380 10 380GTZ	385.332-333/335/338/383/385/387/395/397/399			
			 3151 000 375	KZIS-4	385.332-333/335/338/383/385/387/395/397/399			
		OM402.927, OM402.910	 1882 288 131	380 GF380N	385.395/397 für Nebenantrieb / for PTO	(82)		
			 1878 000 964	380 10 380GTZ	385.395/397 für Nebenantrieb / for PTO	(82)		
			 1861 643 134 #	420 10 420GSZ	385.383/385/387/394/396-398 für Nebenantrieb / for PTO	(82)		
			 3151 079 031	KZI-6	385.383/385/387/394/396-398 für Nebenantrieb / for PTO	(82)		
		2224 S 385.399	07.76 - 12.82	OM402	 1882 302 131	380 GF380	385.332-333/335/338/383/385/387/395/397/399	
					 1878 000 105	380 10 380GTZ	385.332-333/335/338/383/385/387/395/397/399	
					 3151 000 375	KZIS-4	385.332-333/335/338/383/385/387/395/397/399	
LP 2224			 3482 124 534	430 GMF430				
			 1882 301 239 ●	420 GF420				
			 1861 410 047 #	420 10 420/ 210GSZ				
			 3151 000 529	KZIS-4				











		CODE				
--	--	------	--	---	---	---

MERCEDES-BENZ









2224

LP,LPB,LPK,LPS 2224 355.452 361.465 361.453 361.455-457 361.467 355.462 361.463				1882 166 737	380 GF380		
				1878 000 104	380 10 380GTZ		
				3151 000 529	KZIS-4		
LP,LPB,LPS 2224 361.463 361.453 361.465 361.455/456				1882 288 131	380 GF380N	für Nebenantrieb / for PTO	(82)





2225

2225 617.033 619.017 619.034 619.019	04.85 - 03.91	OM422		1882 302 135 #	380 GF380		
				1878 000 105	380 10 380GTZ		
				3151 000 375	KZIS-4		
				3151 000 375	KZIS-4	-> Chass. 5107148 617.033	
				3151 126 031	KZI-4,5	Chass. 5107149-> 617.033	
2225 B 619.048 617.532 619.049	08.83 - 03.91	OM422		3482 124 534	430 GMF430		
				1882 301 239 ●	420 GF420		
				1878 002 706	420 10 420GTZ		
				3151 126 031	KZI-4,5		
			OM421		1861 643 134 #	420 10 420GSZ	619.048-049 Nebenantriebs-ID / PTO ID: 3/90
				3151 079 031	KZI-6	619.048-049 Nebenantriebs-ID / PTO ID: 3/90	(48)

2226

























2226 393.316 393.315 2226,2226 L 393.374 393.376 393.576 393.375 393.377 393.574/575	09.75 - 12.80	OM402		1882 302 131	380 GF380		
	08.73 - 09.96			1878 000 105	380 10 380GTZ		
				1878 000 105	380 10 380GTZ	393.311/315-316/374-377	
				3151 000 375	KZIS-4		
LP,LPB,LPK,LPS 2226 363.021 363.481/482 363.471-474 363.026		OM402		1882 166 737	380 GF380		
				1878 000 104	380 10 380GTZ		
LPB 2226				1882 288 131	380 GF380N	Nebenantriebs-ID / PTO ID: 110	(48)
LPB 2226				1882 288 131	380 GF380N	Nebenantriebs-ID / PTO ID: 80,90	(48)

2227

LP 2217	06.69 -	OM324		1882 234 433	350 GF350		
				1878 001 074	350 10 350GTZ		
				3151 044 031	KZI-3		
LP 2217	- 05.69	OM324		1878 001 074	350 10 350GTZ		
LP 2217 355,360 LPB 2217 355,360				1878 001 074	350 10 350GTZ	Nebenantriebs-ID / PTO ID: 70,80	(48)

		CODE				
--	--	------	--	---	---	---



MERCEDES-BENZ

2228						
2228 623.032/033	12.79-03.91	OM422	 1800 125 301 ⊗ 1882 301 239 ⊗ 1878 002 706 • 3151 000 375	420 10 GF420 420GTZ KZIS-4	623.032-033/130	
			 3482 124 534 ●	430 GMF430	623.032-033/130	
2228 S 623.180 623.130	12.79-03.91	OM421, 422	 1882 342 134	420 GF420X	623.180	
			 1878 002 878	420 10 420GTZ	623.180	
			 3151 110 031	KZI-4,5	623.180	
		OM422	 3482 124 534	430 GMF430	623.032-033/130/180	
			1882 301 239 ●	420 GF420	623.032-033/130/180	
			 1878 002 706	420 10 420GTZ	623.032-033/130/180	
			 3151 000 375	KZIS-4	623.032-033/130/180	
2228,2228 L 623.058 623.007 623.458 617.033 623.008 623.407 623.006 623.009 623.408	08.73-09.96	OM422	 3482 124 534	430 GMF430	623.006-007-008-009/058/407-408/458	
			1882 301 239 ●	420 GF420	623.006-007-008-009/058/407-408/458	
			 1878 002 706	420 10 420GTZ	623.006-007-008-009/058/407-408/458	
			 3151 000 375	KZIS-4	623.006-007-008-009/058/407-408/458	
		OM422.905, OM422.911, OM422.906	 1882 304 237	420 GF420N	623.006-007 für Nebenantrieb / for PTO	(82)
			 1878 003 269	420 10 420GTZ	623.006-007 für Nebenantrieb / for PTO	(82)
			 3151 204 001	KZI-6	623.006-007 für Nebenantrieb / for PTO mit Schmierrohranschluß / with lubricating pipe coupling	(82) (91)
2232						
2232 393.316 393.38 393.375 393.32 393.374 393.376/377 393.315 393.311		OM402, 403	 1882 302 131	380 GF380	393.311/315-316/374-375-376-377	
			 1878 000 105	380 10 380GTZ	393.311/315-316/374-375-376-377	
			 3151 000 375	KZIS-4	393.311/315-316/374-375-376-377	
		OM423	 3482 124 522	430 GMF430	393.32/38	
			 1878 002 706	420 10 420GTZ	393.32/38	
2232 393.325/326 2232,2232 L 393.385 393.387 393.384 393.585 393.386 393.586 2232 S,2232 LS 393.521 393.321 2232 L 393.576 393.511 393.575 393.574	05.74-09.83	OM403	 1800 125 301 ⊗ 1882 301 239 ⊗ 1878 002 706 • 3151 000 375	420 10 GF420 420GTZ KZIS-4	393.321/325-326/384-387/521/585-586	
	08.73-09.96		 3482 124 534 ●	430 GMF430	393.321/325-326/384-387/521/585-586	
	08.73-09.96					
LP 2232 363.481 363.471-482		OM403	 1882 166 737	380 GF380		
			 1878 000 104	380 10 380GTZ		
			 1882 304 237	420 GF420N	Nebenantriebs-ID / PTO ID: 110	(48)















		CODE				
--	--	------	--	---	---	---

MERCEDES-BENZ













2232

LP,LPL,LPK,LPS 2232 363.452 363.461 363.076 363.072 363.077 363.071 363.454 363.451 363.462 363.464		OM403		3482 124 534	430 GMF430	363.461-462/464/071-072/076-077/451-452/454	
				1882 301 239 ●	420 GF420	363.461-462/464/071-072/076-077/451-452/454	
					1861 410 047 #	420 10 420/ 210GSZ	363.461-462/464/071-072/076-077/451-452/454

2233











2233 623.048 2233,2233 L 623.073 623.423 623.473 623.023	11.80 - 05.87	OM422A, 423		1882 342 134	420 GF420X	623.023/048/073/423/473		
	08.73 - 09.96				1878 002 878	420 10 420GTZ	623.023/048/073/423/473	
					3151 110 031	KZI-4,5	623.023/048/073/423/473	
					1882 346 131 #	420 GF420XN	623.023/048 für Nebenantrieb / for PTO	(82)
					1878 002 706	420 10 420GTZ	623.023/048 für Nebenantrieb / for PTO	(82)
2233 S 623.145 623.195	11.80 - 05.87	OM422A, 423		1882 342 134	420 GF420X			
				1878 002 878	420 10 420GTZ			
				3151 110 031	KZI-4,5			
			OM423		1888 042 009	380 GF2/380	623.145 enthält eine Kupplungsscheibe / This part number includes one clutch disc Sonderausführung / Special design	(66) (56)
					1878 000 968 ▽	380 10 380GTZ	623.145 Sonderausführung / Special design Lose Kupplungsscheibe / Loose clutch disc	(56) (39)
					3151 108 031	KZI-4,5	623.145 Sonderausführung / Special design	(56)
					1882 341 001	380 GF2/380	623.145 In 1888 enthalten / Contained in 1888 Sonderausführung / Special design	(29) (56)
					1859 250 102	380 GF2/380	623.145 In 1888 enthalten / Contained in 1888 Sonderausführung / Special design	(29) (56)
				1878 000 968 △	380 10 380GTZ	623.145 Sonderausführung / Special design In 1888 enthalten / Contained in 1888	(56) (29)	







2235













2235,2235 L 648.012 648.038 648.413 648.063 648.463 648.013 2235 K 648.137 2235 S, 2235 LS 648.111 648.135 648.463	08.73 - 09.96	OM422A, 442A		1888 055 041	380 GF2/380	648.012-013/038/063/111/135/137/413/463 enthält eine Kupplungsscheibe / This part number includes one clutch disc	(66)	
	03.86 - 07.89				1862 135 035 ▽	380 10 380GS	648.012-013/038/063/111/135/137/413/463 Lose Kupplungsscheibe / Loose clutch disc	(39)
	08.73 - 09.96				3151 108 031	KZI-4,5	648.012-013/038/063/111/135/137/413/463	
					1882 349 003	380 GF2/380	648.012-013/038/063/111/135/137/413/463 In 1888 enthalten / Contained in 1888	(29)
					1859 250 100	380 GF2/380	648.012-013/038/063/111/135/137/413/463 In 1888 enthalten / Contained in 1888	(29)
					1862 138 032 △	380 10 380GSZ	648.012-013/038/063/111/135/137/413/463 In 1888 enthalten / Contained in 1888	(29)
					1888 063 137	380 GF2/380N	648.038 für Nebenantrieb / for PTO enthält eine Kupplungsscheibe / This part number includes one clutch disc	(82) (66)
					1862 304 033	380 10 380GV	648.038 für Nebenantrieb / for PTO	(82)
					3151 204 001	KZI-6	648.038 für Nebenantrieb / for PTO mit Schmierrohranschluß / with lubricating pipe coupling	(82) (91)
					1882 304 237	420 GF420N	648.137 für Nebenantrieb / for PTO	(82)
					1878 003 269	420 10 420GTZ	648.137 für Nebenantrieb / for PTO	(82)
					3151 204 001	KZI-6	648.137 für Nebenantrieb / for PTO	(82)

		CODE				
--	--	------	--	---	---	---

MERCEDES-BENZ

2236						
2236 623.058 623.012/013	09.82 - 03.91	OM422		1800 125 301 ● 1882 301 239 ● 1878 002 706 ● 3151 000 375	420 10 GF420 420GTZ KZIS-4	
				3482 124 534 ●	430 GMF430	
		OM422A, 423		1882 342 134	420 GF420X	
				1878 002 878	420 10 420GTZ	
				3151 110 031	KZI-4,5	
				1882 346 131 #	420 GF420XN	für Nebenantrieb / for PTO (82)
				1878 002 706	420 10 420GTZ	für Nebenantrieb / for PTO (82)
2236 S 623.135	12.84 - 03.91	OM422A, 423		1882 342 134	420 GF420X	
				1878 002 878	420 10 420GTZ	
				3151 110 031	KZI-4,5	

2238							
2238,2238 L 623.468 623.068 2238 S 623.190	08.73 - 09.96	OM422LA		1888 042 009	380 GF2/380	623.068/190/468 enthält eine Kupplungsscheibe / This part number includes one clutch disc (66)	
				1878 000 968 ▽	380 10 380GTZ	623.068/190/468 Lose Kupplungsscheibe / Loose clutch disc (39)	
				3151 108 031	KZI-4,5	623.068/190/468	
	01.81 - 12.86				1882 341 001	380 GF2/380	623.068/190/468 In 1888 enthalten / Contained in 1888 (29)
					1859 250 102	380 GF2/380	623.068/190/468 In 1888 enthalten / Contained in 1888 (29)
					1878 000 968 △	380 10 380GTZ	623.068/190/468 In 1888 enthalten / Contained in 1888 (29)

2244						
2244,2244 L 648.073 648.473	08.73 - 09.96	OM442LA		1888 055 247	380 GF2/380	648.073/473 enthält eine Kupplungsscheibe / This part number includes one clutch disc (66)
				1862 123 131 ▽	380 10 380GV	648.473 Lose Kupplungsscheibe / Loose clutch disc (39)
				3151 108 031	KZI-4,5	648.073/473
				1882 349 003	380 GF2/380	648.473 In 1888 enthalten / Contained in 1888 (29)
				1859 250 100	380 GF2/380	648.473 In 1888 enthalten / Contained in 1888 (29)
				1862 122 132 △	380 10 380GVZ	648.473 In 1888 enthalten / Contained in 1888 (29)
2244 S 648.195	10.85 - 07.89	OM442LA		1888 055 247	380 GF2/380	enthält eine Kupplungsscheibe / This part number includes one clutch disc (66)
				1862 123 131 ▽	380 10 380GV	Lose Kupplungsscheibe / Loose clutch disc (39)
				3151 108 031	KZI-4,5	
				1882 349 003	380 GF2/380	In 1888 enthalten / Contained in 1888 (29)
				1859 250 100	380 GF2/380	In 1888 enthalten / Contained in 1888 (29)
				1862 122 132 △	380 10 380GVZ	In 1888 enthalten / Contained in 1888 (29)

2327						
2327 L 654.446				3400 700 411 ● 3482 081 232 ● 1878 080 033 ● 3151 000 278	430 10 MFZ430 430WGTZ KZISZ-5	Chass. K 017132->



		CODE				
--	--	------	--	---	---	---





MERCEDES-BENZ

2420						
2420,2420 L 653.414 654.413 653.012 653.411/412 654.411 653.011 653.014	12.87 - 09.96	OM356, 366LA		3400 125 001 ⊗ 3482 000 953 ⊗ 1878 001 070 ◊ 3151 000 374	350 10 GMF350X 350GTZ KZIS-4	

2422						
2422 653.038 653.036/037	09.89 - 08.94	OM401LA, 441		3400 123 001 ⊗ 3482 081 232 ⊗ 1878 080 031 ◊ 3151 000 549	430 10 MFZ430 430WGTZ KZISZ-5	653.017/019/036-037-038/074/076/137-138/417 /419 654.416-417-418 656.009
2422,2422 L 653.019 653.417 653.419 652.036 653.017	12.87 - 09.96					653.017/019/036-037-038/074/076/137-138/417 /419 654.416-417-418 656.009
2422 B 653.074 653.076	09.89 - 08.94					
2422 K 653.137/138	09.89 - 08.94					
2422 L 654.416 654.418 654.417	12.87 - 09.96					
2422 L 656.009	07.87 - 09.96					
2422 L 654.417/418 654.416	12.87 - 09.96					





2425						
2425 617.033	04.85 - 03.91	OM422		1882 302 135 #	380 GF380	617.033
				1878 000 105	380 10 380GTZ	617.033
				3151 000 375	KZIS-4	->Chass. 5107148 617.033
				3151 126 031	KZI-4,5	Chass. 5107149-> 617.033























2426						
2426 652.047 652.046	12.87 - 09.96	OM441, 442		3400 124 101 ⊗ 3482 081 232 ⊗ 1878 005 668 ◊ 3151 000 549	430 10 MFZ430 430WGTZ KZISZ-5	652.046-047 653.044/077/079 654.418/422
2426 653.044	01.90 - 08.94					652.046-047 653.044/079 654.422
2426 B 653.077 653.079	02.90 - 08.94	OM442		1862 268 031	420 10 420GVZ	652.046-047 653.044/079 654.422 für Nebenantrieb / for PTO
2426, 2426 L 652.046 652.447 652.047 654.422	02.90 - 08.94					3151 166 031
2426 L 654.422	02.90 - 08.94					(82)
2426 L 654.422	02.90 - 08.94					(82)

2427						
2427 ,L 653.417		OM401LA, 441		3400 123 001 ⊗ 3482 081 232 ⊗ 1878 080 031 ◊ 3151 000 549	430 10 MFZ430 430WGTZ KZISZ-5	
2427 B 653.077	02.90 - 08.94	OM401LA, 442		3400 124 101 ⊗ 3482 081 232 ⊗ 1878 005 668 ◊ 3151 000 549	430 10 MFZ430 430WGTZ KZISZ-5	653.077
2427 B 653.077	02.90 - 08.94					
2427 L 654.418	12.87 - 09.96	OM401LA, 442		3400 123 001 ⊗ 3482 081 232 ⊗ 1878 080 031 ◊ 3151 000 549	430 10 MFZ430 430WGTZ KZISZ-5	654.418
				1862 225 132 #	400 10 400GTZ	654.418

		CODE					
--	--	------	--	--	---	---	---







MERCEDES-BENZ





















2428							
2428 621.016/017 621.015	08.73 - 09.96	OM422		1800 125 301 ⊗ 1882 301 239 ⊗ 1878 002 706 ⊙ 3151 000 375	420 10 GF420 420GTZ KZIS-4	621.015-016-017/066/416/466	
				3482 124 534 ●	430 GMF430	621.015-016-017/066/416/466	
		OM422.905, OM422.911, OM422.913, OM422.916		1882 304 237	420 GF420N	621.015-016-017/111-112-113 für Nebenantrieb / for PTO	(82)
				1878 634 014	420 10 420GSZ	621.015-016-017/111-112-113 für Nebenantrieb / for PTO	(82)

2429							
2429 656.018 656.416 656.016 656.015		OM442		3400 124 101 ⊗ 3482 081 232 ⊗ 1878 005 668 ⊙ 3151 000 549	430 10 MFZ430 430WGTZ KZISZ-5	656.416	
				1862 268 031	420 10 420GVZ	652.043/045 Nebenantriebs-ID / PTO ID: 4/120	(48)
				3151 166 031	KZI-6	652.043/045 Nebenantriebs-ID / PTO ID: 4/120	(48)
		OM422, 442		3482 081 232	430 MFZ430	656.015-016/018	
				1878 005 668	430 10 430WGTZ	656.015-016/018	
				3151 000 278	KZISZ-5	656.015-016/018	
				1888 063 137	380 GF2/380N	Nebenantriebs-ID / PTO ID: 4/125 enthält eine Kupplungsscheibe / This part number includes one clutch disc	(48) (66)
				1862 304 033 ▽	380 10 380GV	Nebenantriebs-ID / PTO ID: 4/125 Lose Kupplungsscheibe / Loose clutch disc	(48) (39)
				3151 166 031	KZI-6	Nebenantriebs-ID / PTO ID: 4/125	(48)
				1882 019 133	380 GF2/380N	In 1888 enthalten / Contained in 1888	(29)
				1859 250 101	380 GF2/380	In 1888 enthalten / Contained in 1888	(29)
				1862 305 033 △	380 10 380GVZ	In 1888 enthalten / Contained in 1888	(29)
		2429 658.032/033 2429 K 658.132 658.134	07.88 - 08.94	OM442		3400 124 101 ⊗ 3482 081 232 ⊗ 1878 005 668 ⊙ 3151 000 549	430 10 MFZ430 430WGTZ KZISZ-5
07.88 - 08.94			3400 122 501 ⊗ 3482 081 232 ⊗ 1878 634 027 ⊙ 3151 000 278		430 10 MFZ430 430WGTZ KZISZ-5		
OM442.925, OM442.906, OM442.923, OM442.907			1888 063 137	380 GF2/380N	Nebenantriebs-ID / PTO ID: 4/125 enthält eine Kupplungsscheibe / This part number includes one clutch disc	(48) (66)	
			1862 304 033 ▽	380 10 380GV	Nebenantriebs-ID / PTO ID: 4/125 Lose Kupplungsscheibe / Loose clutch disc	(48) (39)	
			3151 166 031	KZI-6	Nebenantriebs-ID / PTO ID: 4/125	(48)	
			1882 019 133	380 GF2/380N	In 1888 enthalten / Contained in 1888	(29)	
		1859 250 101	380 GF2/380	In 1888 enthalten / Contained in 1888	(29)		
	1862 305 033 △	380 10 380GVZ	In 1888 enthalten / Contained in 1888	(29)			
2429,2429 L 658.408 658.001 658.006/007 658.009 658.407 658.008 2429 S 658.130 2429 S,2429 LS 657.105 657.505	07.87 - 09.96	OM442		3400 124 101 ⊗ 3482 081 232 ⊗ 1878 005 668 ⊙ 3151 000 549	430 10 MFZ430 430WGTZ KZISZ-5		
	07.88 - 08.94			3400 122 501 ⊗ 3482 081 232 ⊗ 1878 634 027 ⊙ 3151 000 278	430 10 MFZ430 430WGTZ KZISZ-5		
	07.87 - 09.96						

		CODE				
--	--	------	--	---	---	---



MERCEDES-BENZ

2431								
2431 652.096 652.095 652.097 2431 652.096/097 652.095	12.87 - 09.96	OM401LA, 441LA		3400 124 001 ● 3482 081 231 ● 1878 634 027 ● 3151 000 278	430 10 MFZ430 430WGTZ KZISZ-5	652.095-097		
	12.87 - 09.96	OM401.979, OM401.972, OM401.993		1888 063 137	380 GF2/380N	652.095-097 Nebenantriebs-ID / PTO ID: 4/125 enthält eine Kupplungsscheibe / This part number includes one clutch disc	(48) (66)	
					1862 304 033 ▽	380 10 380GV	652.095-097 Nebenantriebs-ID / PTO ID: 4/125 Lose Kupplungsscheibe / Loose clutch disc	(48) (39)
					3151 166 031	KZI-6	652.095-097 Nebenantriebs-ID / PTO ID: 4/125	(48)
					1882 019 133	380 GF2/380N	652.095-097 In 1888 enthalten / Contained in 1888	(29)
					1859 250 101	380 GF2/380	652.095-097 In 1888 enthalten / Contained in 1888	(29)
					1862 305 033 △	380 10 380GVZ	652.095-097 In 1888 enthalten / Contained in 1888	(29)















2433									
2433 621.046/047	11.80 - 03.91	OM422A, 423		1882 342 134	420 GF420X	621.046			
				1878 002 878	420 10 420GTZ	621.046			
				3151 110 031	KZI-4,5	621.046			
2433 623.023	10.80 - 09.96	OM422A, 423		1882 342 134	420 GF420X	623.023			
				1878 002 878	420 10 420GTZ	623.023			
				3151 110 031	KZI-4,5	623.023			
2433 654.422 623.023 621.046 623.408		OM441, 442		3400 124 101 ● 3482 081 232 ● 1878 005 668 ● 3151 000 549	430 10 MFZ430 430WGTZ KZISZ-5	654.422			
		OM422A, 423		1882 342 134	420 GF420X	621.046 623.023			
				1878 002 878	420 10 420GTZ	621.046 623.023			
				3151 110 031	KZI-4,5	621.046 623.023			
		OM441		1878 087 141 ▽	380 10 380GT	623.408 Lose Kupplungsscheibe / Loose clutch disc	(39)		
				3151 182 031	KZI-5	623.408			
		OM442		1862 268 031	420 10 420GVZ	654.422 Nebenantriebs-ID / PTO ID: 4/120	(48)		
				3151 166 031	KZI-6	654.422 Nebenantriebs-ID / PTO ID: 4/120	(48)		
		2433,2433 L, 2434 L 653.464 653.064 653.463 653.061 653.475 653.062 652.067 653.462 652.466 653.063 652.467/468 653.461 2433 K 653.158 2433 S,2433 LS 654.155 654.555	12.87 - 09.96	OM441LA		3400 124 001 ● 3482 081 231 ● 1878 634 027 ● 3151 000 278	430 10 MFZ430 430WGTZ KZISZ-5		
			09.89 - 07.92	OM441.986, OM441.962, OM441.989, OM445.920,		1888 063 137	380 GF2/380N	653.158 für Nebenantrieb / for PTO enthält eine Kupplungsscheibe / This part number includes one clutch disc	(82) (66)
12.87 - 09.96	OM441.981, OM441.983, OM445.939, OM441.960			1862 304 033 ▽	380 10 380GV	653.158 für Nebenantrieb / for PTO Lose Kupplungsscheibe / Loose clutch disc	(82) (39)		
					3151 166 031	KZI-6	653.158 für Nebenantrieb / for PTO	(82)	
					1882 019 133	380 GF2/380N	653.158 In 1888 enthalten / Contained in 1888	(29)	
					1859 250 101	380 GF2/380	653.158 In 1888 enthalten / Contained in 1888	(29)	
					1862 305 033 △	380 10 380GVZ	653.158 In 1888 enthalten / Contained in 1888	(29)	







		CODE				
--	--	------	--	---	---	---

MERCEDES-BENZ

2433						
2433 L 654.422	12.87 - 09.96	OM441, 442		3400 124 101 ⊗ 3482 081 232 ⊗ 1878 005 668 ⊙ 3151 000 549	430 10 MFZ430 430WGTZ KZISZ-5	654.422
	12.87 - 09.96	OM442		1862 268 031	420 10 420GVZ	654.422 Nebenantriebs-ID / PTO ID: 4/120 (48)
2433 L 654.422				3151 166 031	KZI-6	654.422 Nebenantriebs-ID / PTO ID: 4/120 (48)











2434						
2434 L 658.408	07.87 - 09.96	OM441LA		3400 124 101 ⊗ 3482 081 232 ⊗ 1878 005 668 ⊙ 3151 000 549	430 10 MFZ430 430WGTZ KZISZ-5	658.408

2435						
2435 656.076 656.327 656.026 655.426 656.025 655.026 656.074	07.87 - 09.96	OM442A		3400 122 601 ⊗ 3482 081 231 ⊗ 1878 080 037 ⊙ 3151 000 278	430 10 MFZ430 430WGTZ KZISZ-5	655.026 656.025-026/028/327
		OM442.966, OM442.976, OM440.942, OM442.962, OM442.963, OM442.944, OM442.978, OM440.941, OM442.942		1888 063 137	380 GF2/380N	656.025-026/028/327 655.026 Nebenantriebs-ID / PTO ID: 4/125 enthält eine Kupplungsscheibe / This part number includes one clutch disc (48) (66)
			1862 304 033 ▽	380 10 380GV	656.025-026/028/327 655.026 Nebenantriebs-ID / PTO ID: 4/125 Lose Kupplungsscheibe / Loose clutch disc (48) (39)	
			3151 166 031	KZI-6	656.025-026/028/327 655.026 Nebenantriebs-ID / PTO ID: 4/125 (48)	
			1882 019 133	380 GF2/380N	656.025-026/028/327 655.026 In 1888 enthalten / Contained in 1888 (29)	
			1859 250 101	380 GF2/380	656.025-026/028/327 655.026 In 1888 enthalten / Contained in 1888 (29)	
			1862 305 033 △	380 10 380GVZ	656.025-026/028/327 655.026 In 1888 enthalten / Contained in 1888 (29)	
2435 658.016 658.038 658.116 658.137 658.139 658.014/015 658.012 658.063 658.017 658.019 658.013 658.018 2435,2435 L 658.463 658.063 658.413 658.012/013 2435 K 658.137 658.139 2435 S 658.135 2435 S,2435 LS 657.110 658.116 657.510 657.560 2435 LS 658.463	07.88 - 08.94	OM442A		3400 122 601 ⊗ 3482 081 231 ⊗ 1878 080 037 ⊙ 3151 000 278	430 10 MFZ430 430WGTZ KZISZ-5	
	07.87 - 09.96	OM442.964, OM442.976, OM442.963, OM442.944, OM442.968, OM440.940, OM442.943, OM442.965		1888 063 137	380 GF2/380N	für / for: SA32910-01 Nebenantriebs-ID / PTO ID: 4/125 enthält eine Kupplungsscheibe / This part number includes one clutch disc (68) (48) (66)
			1862 304 033 ▽	380 10 380GV	für / for: SA32910-01 Nebenantriebs-ID / PTO ID: 4/125 Lose Kupplungsscheibe / Loose clutch disc (68) (48) (39)	
			3151 166 031	KZI-6	für / for: SA32910-01 Nebenantriebs-ID / PTO ID: 4/125 (68) (48)	
			1882 019 133	380 GF2/380N	für / for: SA32910-01 In 1888 enthalten / Contained in 1888 (68) (29)	
			1859 250 101	380 GF2/380	für / for: SA32910-01 In 1888 enthalten / Contained in 1888 (68) (29)	
			1862 305 033 △	380 10 380GVZ	für / for: SA32910-01 In 1888 enthalten / Contained in 1888 (68) (29)	

2438						
2438 623.068	08.73 - 09.96	OM422LA		1888 042 009	380 GF2/380	623.068 enthält eine Kupplungsscheibe / This part number includes one clutch disc (66)
				1878 000 968 ▽	380 10 380GTZ	623.068 Lose Kupplungsscheibe / Loose clutch disc (39)
				3151 108 031	KZI-4,5	623.068
				1882 341 001	380 GF2/380	623.068 In 1888 enthalten / Contained in 1888 (29)
				1859 250 102	380 GF2/380	623.068 In 1888 enthalten / Contained in 1888 (29)
				1878 000 968 △	380 10 380GTZ	623.068 In 1888 enthalten / Contained in 1888 (29)

		CODE				
--	--	------	--	---	---	---





































MERCEDES-BENZ

2448						
2448 658.195 2448,2448 L 658.473 658.070/071 658.073 2448 LS 658.195 657.585 657.510 658.473 2448 S 658.195	07.88 - 07.92 07.87 - 09.96 07.88 - 07.92 07.88 - 07.92	OM442LA	 3400 121 601 ⊗ 3488 017 432 ⊗ 1878 634 022 ⊙ 3151 000 547	400 10 MFZ2/400X 400GVZ KZISZ-5	-->Chass. K011863	
			 3400 122 901 ⊗ 3482 081 233 ⊗ 1878 002 735 ⊙ 3151 000 278	430 10 MFZ430 430GTZ KZISZ-5	Chass. K011864->	
			 3400 121 601 ⊗ 3488 017 432 ⊗ 1878 634 022 ⊙ 3151 000 547	400 10 MFZ2/400X 400GVZ KZISZ-5	für / for: SA33613-03 Sonderausführung / Special design	(68) (56)
2448 L 657.510	01.88 -	OM442	 3400 122 601 ⊗ 3482 081 231 ⊗ 1878 080 037 ⊙ 3151 000 278	430 10 MFZ430 430WGTZ KZISZ-5		
2448 LS 655.593	01.88 -	OM442LA	 3400 121 601 ⊗ 3488 017 432 ⊗ 1878 634 022 ⊙ 3151 000 547	400 10 MFZ2/400X 400GVZ KZISZ-5	für Ausrückgabel mit Rollen / for release fork with rollers	(70)
2522						
2522 L 654.417 2522 L 654.417	12.87 - 09.96 12.87 - 09.96	OM441	 3400 123 001 ⊗ 3482 081 232 ⊗ 1878 080 031 ⊙ 3151 000 549	430 10 MFZ430 430WGTZ KZISZ-5	654.417	
2524						
2524 653.042 653.040 653.050-054		OM401LA, 441LA	 3400 124 001 ⊗ 3482 081 231 ⊗ 1878 634 027 ⊙ 3151 000 278	430 10 MFZ430 430WGTZ KZISZ-5		
2524 653.031 653.036 653.033 653.032 2524 653.031-033 2524 K 653.128 2524 K 653.128	06.92 - 09.96 01.94 - 09.96 06.92 - 09.96 01.94 - 09.96	OM401LA, 441LA	 3400 700 411 ⊗ 3482 081 232 ⊗ 1878 080 033 ⊙ 3151 000 278	430 10 MFZ430 430WGTZ KZISZ-5	653.128/148/022/024/031-033/047/049/070/072	
2524,2524 L 653.022 654.417 654.426 653.024 654.416 654.427 653.429 654.428 653.427 654.418 2524,2524 L 653.427 654.416 653.022 654.428 654.417/418 653.024 654.426/427 653.429 2524 L 652.405 653.417 652.409 2524 L 652.405 652.409	12.87 - 09.96 12.87 - 09.96 12.87 - 09.96 12.87 - 09.96	OM401LA, 441LA	 3400 123 001 ⊗ 3482 081 232 ⊗ 1878 080 031 ⊙ 3151 000 549  3400 700 411 ⊗ 3482 081 232 ⊗ 1878 080 033 ⊙ 3151 000 278	430 10 MFZ430 430WGTZ KZISZ-5 430 10 MFZ430 430WGTZ KZISZ-5	653.036/417 654.416-418 653.128/148/022/024/031-033/047/049/070/072 652.405/409 653.427/429 654.426-428	





		CODE				
--	--	------	--	---	---	---

MERCEDES-BENZ

2527

2527 653.047 652.055 653.049 2527 652.055 654.433 653.427 654.432 653.047 653.022 653.148 653.049 2527 B 653.072 653.070 2527 B 653.072 653.070 2527 K 653.148 2527 K 653.148 2527 L 652.455 652.458 653.427 652.457 654.433 653.429 654.432	10.93 - 09.96	OM401LA, 441LA	 3400 700 411  3482 081 232  1878 080 033  3151 000 278	430 10 MFZ430 430WGTZ KZISZ-5	653.022/047/049/070/072/148/427-428		
	01.94 - 09.96	OM401.980, OM445.927, OM401.978,	 1888 063 137	380 GF2/380N	653.047/049/148 652.055 für Nebenantrieb / for PTO enthält eine Kupplungsscheibe / This part number includes one clutch disc	(82) (66)	
	03.91 - 09.96	OM445.936, OM445.926, OM401.973, OM445.929, OM445.940	 1862 304 033 ▽	380 10 380GV	653.047/049/148 652.055 für Nebenantrieb / for PTO Lose Kupplungsscheibe / Loose clutch disc	(82) (39)	
	01.94 - 09.96		 3151 166 031	KZI-6	653.047/049/148 652.055 für Nebenantrieb / for PTO	(82)	
	10.93 - 09.96		 1882 019 133	380 GF2/380N	653.047/049/148 652.055 für Nebenantrieb / for PTO In 1888 enthalten / Contained in 1888	(82) (29)	
	01.94 - 09.96		 1859 250 101	380 GF2/380	653.047/049/148 652.055 In 1888 enthalten / Contained in 1888	(29)	
	01.94 - 09.96		 1862 305 033 △	380 10 380GVZ	653.047/049/148 652.055 In 1888 enthalten / Contained in 1888	(29)	
			OM401LA, 441LA	 3400 700 411  3482 081 232  1878 080 033  3151 000 278	430 10 MFZ430 430WGTZ KZISZ-5	652.455/457-458 654.426-427	
			OM401LA, 442	 3400 124 101  3482 081 232  1878 005 668  3151 000 549	430 10 MFZ430 430WGTZ KZISZ-5	654.422	
			OM401LA, 442A	 1862 268 031	420 10 420GVZ	Nebenantriebs-ID / PTO ID: 4/120	(48)
			 3151 166 031	KZI-6	Nebenantriebs-ID / PTO ID: 4/120	(48)	
2527 L 653.419 654.417 654.416 654.433 653.417 653.427 654.432 654.427 654.418 654.426	09.92 - 09.96	OM401LA, 441, 442	 3400 123 001  3482 081 232  1878 080 031  3151 000 549	430 10 MFZ430 430WGTZ KZISZ-5	653.417/419 654.416-418		
		OM401LA	 3400 700 411  3482 081 232  1878 080 033  3151 000 278	430 10 MFZ430 430WGTZ KZISZ-5	654.432-433		
2527 L 654.418	03.91 - 08.94	OM401LA, 441, 442	 3400 123 001  3482 081 232  1878 080 031  3151 000 549	430 10 MFZ430 430WGTZ KZISZ-5	653.417/419 654.416-418		
2527 L 652.457 652.455 652.458 2527 L 652.457 652.455 652.458	12.87 - 09.96	OM401LA, 441LA	 3400 700 411  3482 081 232  1878 080 033  3151 000 278	430 10 MFZ430 430WGTZ KZISZ-5	652.455/457-458		
	12.87 - 09.96						









2528

2528 A 621.215 621.214	01.80 - 03.91	OM422.907, OM422.911, OM422.916	 1878 003 269	420 10 420GTZ	621.214 für Nebenantrieb / for PTO	(82)
			 3151 204 001	KZI-6	621.214 für Nebenantrieb / for PTO mit Schmierrohranschluß / with lubricating pipe coupling	(82) (91)
2528 AK 621.312 621.317 621.316	01.80 - 03.91	OM422.907, OM422.911, OM422.913, OM422.916	 1882 304 237	420 GF420N	621.312 für Nebenantrieb / for PTO	(82)
			 1862 268 031	420 10 420GVZ	621.312 für Nebenantrieb / for PTO	(82)
			 3151 204 001	KZI-6	621.312 für Nebenantrieb / for PTO mit Schmierrohranschluß / with lubricating pipe coupling	(82) (91)





















		CODE					
--	--	------	--	--	---	---	---

MERCEDES-BENZ

2529

2529 656.215		OM443A		3482 081 232	430 MFZ430				
				1878 005 668	430 10 430WGTZ				
				3151 000 278	KZISZ-5				
						1888 063 137	380 GF2/380N	Nebenantriebs-ID / PTO ID: 4/125 enthält eine Kupplungsscheibe / This part number includes one clutch disc	(48) (66)
						1862 304 033 ▽	380 10 380GV	Nebenantriebs-ID / PTO ID: 4/125 Lose Kupplungsscheibe / Loose clutch disc	(48) (39)
						3151 166 031	KZI-6	Nebenantriebs-ID / PTO ID: 4/125	(48)
						1882 019 133	380 GF2/380N	In 1888 enthalten / Contained in 1888	(29)
						1859 250 101	380 GF2/380	In 1888 enthalten / Contained in 1888	(29)
						1862 305 033 △	380 10 380GVZ	In 1888 enthalten / Contained in 1888	(29)



























2531

2531 655.307	05.91 - 09.96	OM401LA, 441LA		3400 124 001	430 10 MFZ430	652.095-097/495-498	
	05.91 - 09.96			3482 081 231	430WGTZ	653.040/042/050-054/450-454	
2531 655.307		05.91 - 09.96			1878 634 027	654.012	
				3151 000 278	KZISZ-5	655.005-006/009/307/405-406/408	
2531, 2531 L 655.405 655.005 655.408 655.006 655.406 655.009 656.205	07.87 - 09.96	OM401LA		3400 124 101	430 10 MFZ430	654.422	
				3482 081 232	430WGTZ		
2531, 2531 L 655.405/406 655.005 656.205 655.006 655.009 655.408	07.87 - 09.96			1862 268 031	420 10 420GVZ	654.422 Nebenantriebs-ID / PTO ID: 4/120	(48)
				3151 166 031	KZI-6	654.422 Nebenantriebs-ID / PTO ID: 4/120	(48)
2531, 2531 L 652.096 652.095 652.097 653.451 653.450 653.051 652.496 653.053/054 653.452 653.454 653.042 652.498 653.050 653.453 652.495 653.040 654.012 652.497 653.052	12.87 - 09.96			3400 123 001	430 10 MFZ430	654.416/418	
				3482 081 232	430WGTZ		
2531, 2531 L 652.096 652.495 653.452 652.496 653.040 653.051/052 653.453 652.095 653.050 653.053 654.012 653.054 653.451 653.042 653.454 652.497 652.097 652.498 653.450	12.87 - 09.96			1878 080 031	430 MFZ430	654.426/428/433	
				3482 081 232	430WGTZ		
2531, 2531 L 652.096 652.495 653.452 652.496 653.040 653.051/052 653.453 652.095 653.050 653.053 654.012 653.054 653.451 653.042 653.454 652.497 652.097 652.498 653.450	12.87 - 09.96			1878 080 033	430 10 430WGTZ	654.426/428/433	
				3151 000 278	KZISZ-5	654.426/428/433	
2531 B 653.070	12.87 - 09.96	OM401.979, OM401.986, OM445.930, OM445.937, OM445.920, OM401.972, OM401.993, OM445.929		1888 063 137	380 GF2/380N	653.040/042/051 652.095-097 für Nebenantrieb / for PTO enthält eine Kupplungsscheibe / This part number includes one clutch disc	(82) (66)
				1862 304 033 ▽	380 10 380GV	653.040/042/051 652.095-097 für Nebenantrieb / for PTO Lose Kupplungsscheibe / Loose clutch disc	(82) (39)
2531 L 652.497 652.495/496 652.498	12.87 - 09.96			3151 166 031	KZI-6	653.040/042/051 652.095-097 für Nebenantrieb / for PTO	(82)
2531 L 654.428	12.87 - 09.96			1882 019 133	380 GF2/380N	653.040/042/051 652.095-097 In 1888 enthalten / Contained in 1888	(29)
2531 L 652.498 652.496 652.495 652.497	12.87 - 09.96			1859 250 101	380 GF2/380	653.040/042/051 652.095-097 In 1888 enthalten / Contained in 1888	(29)
2531 L 654.428	12.87 - 09.96			1862 305 033 △	380 10 380GVZ	653.040/042/051 652.095-097 In 1888 enthalten / Contained in 1888	(29)





		CODE		 Parameter		
--	--	------	--	---	---	---

MERCEDES-BENZ



2534

2534,2534 L 653.063 653.461/462 652.065 653.464 653.061 653.064 653.062 653.463 653.465 653.475 2534 K 653.158 2534 S,2534 LS 654.155 654.555	12.87 - 09.96	OM441, LA	 3400 124 001  3482 081 231  1878 634 027  3151 000 278	430 10 MFZ430 430WGTZ KZISZ-5	652.065 653.061-064/158/461-465/475 654.155/555 655.420-423	
	01.91 - 09.96	OM441LA	 3400 700 411  3482 081 232  1878 080 033  3151 000 278	430 10 MFZ430 430WGTZ KZISZ-5	654.426/432-433	
	12.87 - 09.96	OM445.921, OM445.922, OM441.986, OM441.989, OM445.920, OM441.987, OM441.991	 1888 063 137	380 GF2/380N	653.158 für Nebenantrieb / for PTO enthält eine Kupplungsscheibe / This part number includes one clutch disc	(82) (66)
			 1862 304 033 ▽	380 10 380GV	653.158 für Nebenantrieb / for PTO Lose Kupplungsscheibe / Loose clutch disc	(82) (39)
			 3151 166 031	KZI-6	653.158 für Nebenantrieb / for PTO	(82)
			 1882 019 133	380 GF2/380N	653.158 In 1888 enthalten / Contained in 1888	(29)
			 1859 250 101	380 GF2/380	653.158 In 1888 enthalten / Contained in 1888	(29)
		 1862 305 033 △	380 10 380GVZ	653.158 In 1888 enthalten / Contained in 1888	(29)	
2534, 2534 L 655.022 655.422 655.421 655.420 655.423	07.87 - 09.96	OM441, LA	 3400 124 001  3482 081 231  1878 634 027  3151 000 278	430 10 MFZ430 430WGTZ KZISZ-5	655.420-423	
2534 L 654.433 654.432	12.87 - 09.96	OM441LA	 3400 700 411  3482 081 232  1878 080 033  3151 000 278	430 10 MFZ430 430WGTZ KZISZ-5	654.432-433	
2534 L 654.433	12.87 - 09.96	OM441LA	 3400 700 411  3482 081 232  1878 080 033  3151 000 278	430 10 MFZ430 430WGTZ KZISZ-5	654.433	

2535

















2535 L 658.038		OM442A	 3400 122 601  3482 081 231  1878 080 037  3151 000 278	430 10 MFZ430 430WGTZ KZISZ-5		
--------------------------	--	--------	---	---	--	--

2536

2536 AK 621.327 2536 AK 621.327	10.81 - 03.91	OM442.950, OM442.962, OM423.905, OM442.952, OM423.907	 1882 346 131 #	420 GF420XN	621.327 für Nebenantrieb / for PTO	(82)	
	10.81 - 03.91			 1878 002 706	420 10 420GTZ	621.327 für Nebenantrieb / for PTO	(82)
				 3151 204 001	KZI-6	621.327 für Nebenantrieb / for PTO mit Schmierrohranschluß / with lubricating pipe coupling	(82) (91)





































		CODE					
--	--	------	--	--	---	---	---

MERCEDES-BENZ





































2538							
2538 658.043 658.146	03.91 - 09.96	OM402LA, 423, 442LA		3400 122 601 ⊗ 3482 081 231 ⊗ 1878 080 037 ⊙ 3151 000 278	430 10 MFZ430 430WGTZ KZISZ-5		
2538 658.029	03.91 - 09.96						
2538 658.043 658.146	01.94 - 09.96			3400 121 601 HD ⊗ 3488 017 432 ⊗ 1878 634 022 ⊙ 3151 000 547	400 10 MFZ2/400X 400GVZ KZISZ-5	für Fahrzeuge mit Zweis Scheibenkupplung / for vehicles with double disc clutch	(77)
2538 658.043	03.91 - 09.96			3400 122 901 ⊗ 3482 081 233 ⊗ 1878 002 735 ⊙ 3151 000 278	430 10 MFZ430 430GTZ KZISZ-5	für / for: SA033617-01	(68)
2538,2538 L 658.028 658.416 658.419 658.149 658.021 658.023/024 658.078 658.418 658.468/469 658.026/027 658.029 658.466 658.022 658.079	07.87 - 09.96	OM402.971, OM402.975, OM440.970, OM440.971, OM440.978, OM402.985, OM446.925, OM440.981, OM402.986, OM402.989, OM440.980, OM442.997, OM446.924, OM402.972, OM442.989		1888 063 137	380 GF2/380N	für Nebenantrieb / for PTO enthält eine Kupplungsscheibe / This part number includes one clutch disc	(82) (66)
				1862 304 033 ▽	380 10 380GV	für Nebenantrieb / for PTO Lose Kupplungsscheibe / Loose clutch disc	(82) (39)
				3151 166 031	KZI-6	für Nebenantrieb / for PTO	(82)
				1882 019 133	380 GF2/380N	In 1888 enthalten / Contained in 1888	(29)
				1859 250 101	380 GF2/380	In 1888 enthalten / Contained in 1888	(29)
				1862 305 033 △	380 10 380GVZ	In 1888 enthalten / Contained in 1888	(29)
2538 K, 2538 LK 658.149 658.147	03.91 - 09.96						
2538 K, 2538 LK 658.147 658.149	01.94 - 09.96						
2538 K, 2538 LK 658.147 658.149	03.91 - 09.96						
2538 K, 2538 LK 658.147 658.149	03.91 - 09.96						
2538 S 658.146	03.91 - 09.96	OM402LA, 423, 442LA		3400 122 601 ⊗ 3482 081 231 ⊗ 1878 080 037 ⊙ 3151 000 278	430 10 MFZ430 430WGTZ KZISZ-5		
2538 S,2538 LS 657.520 658.146 657.570	07.87 - 09.96						
2538 S,2538 LS 657.520 658.146 657.120 657.570	07.87 - 09.96			3400 122 901 ⊗ 3482 081 233 ⊗ 1878 002 735 ⊙ 3151 000 278	430 10 MFZ430 430GTZ KZISZ-5	für / for: SA033617-01	(68)
2538 S,2538 LS 658.146 657.570	07.87 - 09.96			3400 121 601 HD ⊗ 3488 017 432 ⊗ 1878 634 022 ⊙ 3151 000 547	400 10 MFZ2/400X 400GVZ KZISZ-5	für Fahrzeuge mit Zweis Scheibenkupplung / for vehicles with double disc clutch	(77)
2544							
2544, 2544 L 655.093 658.418/419	01.92 - 09.96	OM442LA		3400 121 601 ⊗ 3488 017 432 ⊗ 1878 634 022 ⊙ 3151 000 547	400 10 MFZ2/400X 400GVZ KZISZ-5	->Chass. K011863	
				3400 122 901 ⊗ 3482 081 233 ⊗ 1878 002 735 ⊙ 3151 000 278	430 10 MFZ430 430GTZ KZISZ-5	Chass. K011864->	
2544 658.146	01.94 - 09.96	OM440.970, OM440.978, OM446.942		3400 122 601 ⊗ 3482 081 231 ⊗ 1878 080 037 ⊙ 3151 000 278	430 10 MFZ430 430WGTZ KZISZ-5		
2544 LS 657.570	01.92 - 09.96						
2544 S 658.135	07.88 - 08.94			3400 122 901 ⊗ 3482 081 233 ⊗ 1878 002 735 ⊙ 3151 000 278	430 10 MFZ430 430GTZ KZISZ-5	für / for: SA033617-01	(68)

		CODE				
--	--	------	--	---	---	---

MERCEDES-BENZ



























































2544						
2544,2544 L 658.050 655.337 658.032 658.053/054 658.051 658.470/471 658.029 658.419 658.418	07.87 - 09.96	OM440, 442LA	 3400 121 601  3488 017 432  1878 634 022  3151 000 547	400 10 MFZ2/400X 400GVZ KZISZ-5	->Chass. K011863 658.050-051/053-054/190/470 655.591 657.580	
			 3400 122 901  3482 081 233  1878 002 735  3151 000 278	430 10 MFZ430 430GTZ KZISZ-5	Chass. K011864-> 658.050-051/053-054/190/470-471 655.591 657.580	
		OM440.970, OM440.978, OM446.922	 3483 023 032 ⊕	445 GMFZ445W	655.337 für Fahrzeuge mit Wandlerschaltkupplung / for vehicles with converter and clutch unit	(76)
		 1878 003 780	445 24 445GTZ	655.337 für Fahrzeuge mit Wandlerschaltkupplung / for vehicles with converter and clutch unit	(76)	
2544 A,K,L,S,LS		OM440, 442A, LA	 3400 122 601  3482 081 231  1878 080 037  3151 000 278	430 10 MFZ430 430WGTZ KZISZ-5	655.138/337/436-437 658.029/043/135/146-147/419 656.327 657.570	
			 3400 122 901  3482 081 233  1878 002 735  3151 000 278	430 10 MFZ430 430GTZ KZISZ-5	für / for: SA033617-01 655.138/337/436-437 658.029/043/135/146-147/419 657.570	(68)
		OM442LA	 3400 124 101  3482 081 232  1878 005 668  3151 000 549	430 10 MFZ430 430WGTZ KZISZ-5	658.032	
		 1888 063 137	380 GF2/380N	655.138/337/436-437 658.029/043 656.327 Nebenantriebs-ID / PTO ID: 4/125 enthält eine Kupplungsscheibe / This part number includes one clutch disc	(48) (66)	
		 1862 304 033 ▽	380 10 380GV	655.138/337/436-437 658.029/043 656.327 Nebenantriebs-ID / PTO ID: 4/125 Lose Kupplungsscheibe / Loose clutch disc	(48) (39)	
		 3151 166 031	KZI-6	655.138/337/436-437 658.029/043 656.327 Nebenantriebs-ID / PTO ID: 4/125	(48)	
		 1882 019 133	380 GF2/380N	655.138/337/436-437 658.029/043 656.327 In 1888 enthalten / Contained in 1888	(29)	
		 1859 250 101	380 GF2/380	655.138/337/436-437 658.029/043 656.327 In 1888 enthalten / Contained in 1888	(29)	
		 1862 305 033 △	380 10 380GVZ	655.138/337/436-437 658.029/043 656.327 In 1888 enthalten / Contained in 1888	(29)	
		2544 S, LS 657.580 658.190 655.591	01.92 - 09.96	OM440, 442LA	 3400 121 601  3488 017 432  1878 634 022  3151 000 547	400 10 MFZ2/400X 400GVZ KZISZ-5
 3400 122 901  3482 081 233  1878 002 735  3151 000 278	430 10 MFZ430 430GTZ KZISZ-5				Chass. K011864-> 658.050-051/053-054/190/470-471 655.591 657.580	

MERCEDES-BENZ

2550							
2550 658.043 658.147 656.028 658.149 656.327		OM402LA, 423, 442A, LA	 3400 122 601  3482 081 231  1878 080 037  3151 000 278	430 10 MFZ430 430WGTZ KZISZ-5	656.028/327 658.043/147/149		
			 3400 122 901  3482 081 233  1878 002 735  3151 000 278	430 10 MFZ430 430GTZ KZISZ-5	für / for: SA033617-01 658.043/147/149	(68)	
		 1888 063 137	380 GF2/380N	656.028/327 658.043 Nebenantriebs-ID / PTO ID: 4/125 enthält eine Kupplungsscheibe / This part number includes one clutch disc	(48) (66)		
		 1862 304 033 ▽	380 10 380GV	656.028/327 658.043 Nebenantriebs-ID / PTO ID: 4/125 Lose Kupplungsscheibe / Loose clutch disc	(48) (39)		
		 3151 166 031	KZI-6	656.028/327 658.043 Nebenantriebs-ID / PTO ID: 4/125	(48)		
		 1882 019 133	380 GF2/380N	656.028/327 658.043 In 1888 enthalten / Contained in 1888	(29)		
		 1859 250 101	380 GF2/380	656.028/327 658.043 In 1888 enthalten / Contained in 1888	(29)		
		 1862 305 033 △	380 10 380GVZ	656.028/327 658.043 In 1888 enthalten / Contained in 1888	(29)		
2550 656.028	07.87 - 09.96	OM442.997, OM442.989	 3400 122 601  3482 081 231  1878 080 037  3151 000 278	430 10 MFZ430 430WGTZ KZISZ-5			
			 1888 063 137	380 GF2/380N	Nebenantriebs-ID / PTO ID: 4/125 enthält eine Kupplungsscheibe / This part number includes one clutch disc	(48) (66)	
			 1862 304 033 ▽	380 10 380GV	Nebenantriebs-ID / PTO ID: 4/125 Lose Kupplungsscheibe / Loose clutch disc	(48) (39)	
			 3151 166 031	KZI-6	Nebenantriebs-ID / PTO ID: 4/125	(48)	
			 1882 019 133	380 GF2/380N	In 1888 enthalten / Contained in 1888	(29)	
			 1859 250 101	380 GF2/380	In 1888 enthalten / Contained in 1888	(29)	
			 1862 305 033 △	380 10 380GVZ	In 1888 enthalten / Contained in 1888	(29)	
2550 658.195	01.91 - 09.96	OM442LA	 3400 121 601  3488 017 432  1878 634 022  3151 000 547	400 10 MFZ2/400X 400GVZ KZISZ-5	->Chass. K011863		
			 3400 122 901  3482 081 233  1878 002 735  3151 000 278	430 10 MFZ430 430GTZ KZISZ-5	Chass. K011864->		
			 3400 121 601  3488 017 432  1878 634 022  3151 000 547	400 10 MFZ2/400X 400GVZ KZISZ-5	für / for: SA33613-03 Sonderausführung / Special design	(68) (56)	



		CODE				
--	--	------	--	---	---	---



MERCEDES-BENZ











2550								
2550,2550 L 658.073 655.496 658.074 658.071 658.473 658.070 658.474	07.87 - 09.96	OM442LA	 3400 121 601  3488 017 432  1878 634 022  3151 000 547	400 10 MFZ2/400X 400GVZ KZISZ-5	->Chass. K011863			
			 3400 122 901  3482 081 233  1878 002 735  3151 000 278	430 10 MFZ430 430GTZ KZISZ-5		Chass. K011864->		
			 3400 121 601  3488 017 432  1878 634 022  3151 000 547	400 10 MFZ2/400X 400GVZ KZISZ-5		für / for: SA33613-03 Sonderausführung / Special design	(68) (56)	
				OM440.971, OM440.973, OM442.998, OM442.997, OM446.920	 1888 063 137	380 GF2/380N	656.028/327 658.043 Nebenantriebs-ID / PTO ID: 4/125 enthält eine Kupplungsscheibe / This part number includes one clutch disc	(48) (66)
					 1862 304 033 ▽	380 10 380GV	656.028/327 658.043 Nebenantriebs-ID / PTO ID: 4/125 Lose Kupplungsscheibe / Loose clutch disc	(48) (39)
					 3151 166 031	KZI-6	656.028/327 658.043 Nebenantriebs-ID / PTO ID: 4/125	(48)
					 1882 019 133	380 GF2/380N	656.028/327 658.043 In 1888 enthalten / Contained in 1888	(29)
					 1859 250 101	380 GF2/380	656.028/327 658.043 In 1888 enthalten / Contained in 1888	(29)
			 1862 305 033 △	380 10 380GVZ	656.028/327 658.043 In 1888 enthalten / Contained in 1888	(29)		
2550 K 658.147 658.149	07.87 - 09.96	OM440.971, OM440.981, OM442.997, OM442.989	 3400 122 601  3482 081 231  1878 080 037  3151 000 278	430 10 MFZ430 430WGTZ KZISZ-5				
			 3400 122 901  3482 081 233  1878 002 735  3151 000 278	430 10 MFZ430 430GTZ KZISZ-5				
2550 S, 2550 LS 657.585 658.195	01.91 - 09.96	OM442LA	 3400 121 601  3488 017 432  1878 634 022  3151 000 547	400 10 MFZ2/400X 400GVZ KZISZ-5	für / for: SA33613/03	(68)		
2553								
2553,2553 L 658.071 658.074 658.474 658.070 658.027 658.073 2553 S, 2553 LS 658.195 655.593	07.87 - 09.96	OM442LA	 3400 121 601  3488 017 432  1878 634 022  3151 000 547	400 10 MFZ2/400X 400GVZ KZISZ-5	->Chass. K011863			
			 3400 122 901  3482 081 233  1878 002 735  3151 000 278	430 10 MFZ430 430GTZ KZISZ-5		Chass. K011864->		
			 3400 121 601  3488 017 432  1878 634 022  3151 000 547	400 10 MFZ2/400X 400GVZ KZISZ-5		für / for: SA33613-03 Sonderausführung / Special design	(68) (56)	
2553 K 658.027 658.149		OM402LA, 423, 442LA	 3400 122 601  3482 081 231  1878 080 037  3151 000 278	430 10 MFZ430 430WGTZ KZISZ-5				
			 3400 122 901  3482 081 233  1878 002 735  3151 000 278	430 10 MFZ430 430GTZ KZISZ-5	für / for: SA033617-01	(68)		
2553 LS 655.593		OM442LA	 3400 121 601  3488 017 432  1878 634 022  3151 000 547	400 10 MFZ2/400X 400GVZ KZISZ-5	->Chass. K011863			
			 3400 122 901  3482 081 233  1878 002 735  3151 000 278	430 10 MFZ430 430GTZ KZISZ-5		Chass. K011864->		







		CODE				
--	--	------	--	---	---	---

MERCEDES-BENZ

2620						
2620 L,LA,LB,LAB 343.		OM346		1882 166 737	380 GF380	
				1878 000 104	380 10 380GTZ	
				3151 000 529	KZIS-4	































2623						
L,LA,LB,LAB,LH,LP 2623 343.		OM355		1882 166 737	380 GF380	
				1878 000 104	380 10 380GTZ	
				3151 000 529	KZIS-4	

2624						
2624 343				1882 166 737	380 GF380	
				1878 000 104	380 10 380GTZ	
				3151 000 529	KZIS-4	
L,LA,LAB,LAS 2624 343.1037104 343.314 343.101 343.301 343.114 343.134 343.303 343.334 343.304 LB,LK,LS,LAK 2624 343.1037104 343.314 343.334 343.101 343.134 343.114 343.301 343.303/304				1882 288 131	380 GF380N	343.301/303-304/314/334/101/1037104/114/134 Nebenantriebs-ID / PTO ID: 80,90 (48)
L,LA,LB,LK,LS 2624 343.301 343.304 343.314 343.134 343.114 343.303 343.103 343.334 343.104 343.101 LAB,LAK,LAS 2624 343.334 343.101 343.104 343.301 343.103 343.134 343.114 343.303/304 343.314		OM355		1882 166 737	380 GF380	343.301/303-304/314/334/101/103-104/114/134
				1878 000 104	380 10 380GTZ	343.301/303-304/314/334/101/103-104/114/134
				3151 000 529	KZIS-4	343.301/303-304/314/334/101/103-104/114/134
L,LK,LS 2624 343.014 343.001 343.004 343.003		OM355		1882 302 131	380 GF380	
				1878 000 105	380 10 380GTZ	
				3151 000 392	KZIS-4	

2626						
2626 395.316 395.315 2626 K 395.342 395.344 2626 S 395.312	06.75 - 03.81	OM402		1882 302 131	380 GF380	395.312/315-316/342/344/412/415/442-443-444
	08.73 - 03.81			1878 000 105	380 10 380GTZ	395.312/315-316/342/344/412/415/442-443-444
	06.75 - 03.81			3482 124 541	430 GMF430	395.312/315-316/342/344/412/415/442-443-444
				1882 301 238 ●#	420 GF420	395.312/315-316/342/344/412/415/442-443-444
				1878 001 136	420 10 420GTZ	395.312/315-316/342/344/412/415/442-443-444
				3151 000 375	KZIS-4	395.312/315-316/342/344/412/415/442-443-444

























		CODE				
--	--	------	--	---	---	---

MERCEDES-BENZ

2626								
2626 A 395.415 2626 AK 395.442-444 2626 AS 395.412	06.75 - 03.81	OM402		1882 302 131	380 GF380	395.312/315-316/342/344/412/415/442-443-444		
	08.73 - 12.81			1878 000 105	380 10 380GTZ	395.312/315-316/342/344/412/415/442-443-444		
	06.75 - 03.81			3482 124 541	430 GMF430	395.312/315-316/342/344/412/415/442-443-444		
				1882 301 238 ●#	420 GF420	395.312/315-316/342/344/412/415/442-443-444		
				1878 001 136	420 10 420GTZ	395.312/315-316/342/344/412/415/442-443-444		
				3151 000 375	KZIS-4	395.312/315-316/342/344/412/415/442-443-444		
				1861 643 134 #	420 10 420GSZ	395.412/415/442-443-444/472 für Nebenantrieb / for PTO	(82)	
2626 AB 395.472	05.74 - 12.80	OM402		1882 302 131	380 GF380	->Chass. 4372223 395.372/472		
				1878 000 105	380 10 380GTZ	->Chass. 4372223 395.372/472		
				3151 000 375	KZIS-4	->Chass. 4372223 395.372/472		
				3482 124 541	430 GMF430	Chass. 4372224-> 395.372/472		
				1882 301 238 ●#	420 GF420	Chass. 4372224-> 395.372/472		
				1878 001 136	420 10 420GTZ	Chass. 4372224-> 395.372/472		
				3151 000 375	KZIS-4	Chass. 4372224-> 395.372/472		
	1861 643 134 #	420 10 420GSZ	395.412/415/442-443-444/472 für Nebenantrieb / for PTO	(82)				
2626 B 395.372	05.74 - 12.80	OM402		1882 302 131	380 GF380	->Chass. 4372223 395.372/472		
				1878 000 105	380 10 380GTZ	->Chass. 4372223 395.372/472		
				3151 000 375	KZIS-4	->Chass. 4372223 395.372/472		
				3482 124 541	430 GMF430	Chass. 4372224-> 395.372/472		
				1882 301 238 ●#	420 GF420	Chass. 4372224-> 395.372/472		
				1878 001 136	420 10 420GTZ	Chass. 4372224-> 395.372/472		
				3151 000 375	KZIS-4	Chass. 4372224-> 395.372/472		
2628								
2628 623.007 624.032/033 623.009 2628 A 624.203 624.232/233 2628 AS 624.331 2628 B 624.030 2628 K 624.132 624.134 2628 S 624.131	02.80 - 03.91	OM422		1800 125 301	420 10 GF420	623.007/009 624.030/032-033/131-132/134/232-233/331		
	02.80 - 03.91			<ul style="list-style-type: none"> ⊙ 1882 301 239 ⊙ 1878 002 706 ⊙ 3151 000 375 	420 10 420GTZ KZIS-4			
	02.80 - 03.91			3482 124 534 ●	430 GMF430	623.007/009 624.030/032-033/131-132/134/232-233/331		
	02.80 - 08.89			OM422.905, OM422.907, OM422.911, OM422.913, OM422.916	1882 304 237	420 GF420N	623.007 624.030/032-033/131-132/134/232-233/331/333 /334 für Nebenantrieb / for PTO	(82)
	02.80 - 03.91				1878 003 269	420 10 420GTZ	623.007 624.030/032-033/131-132/134/232-233/331/333 /334 für Nebenantrieb / for PTO	(82)
	02.80 - 03.91				3151 204 001	KZI-6	623.007 624.030/032-033/131-132/134/232-233/331/333 /334 für Nebenantrieb / for PTO mit Schmierrohranschluß / with lubricating pipe coupling	(82) (91)
	01.90 - 03.91			OM443.940	1878 000 964	380 10 380GTZ	Getr. / GBox: ZF 16S-160 624.233 für Nebenantrieb / for PTO Nebenantriebs-ID / PTO ID: NMV	(82) (48)
				3151 204 001	KZI-6	Getr. / GBox: ZF 16S-160 624.233		









		CODE				
--	--	------	--	---	---	---









MERCEDES-BENZ









2628								
2628 AK 624.333/334	02.80 - 03.91	OM422	 1800 125 301 ⊗ 1882 301 239 ⊗ 1878 002 706 ⊙ 3151 000 375	420 10 GF420 420GTZ KZIS-4	624.333-334			
			 3482 124 534 ●	430 GMF430	624.333-334			
			 1888 042 009	380 GF2/380	624.333-334 enthält eine Kupplungsscheibe / This part number includes one clutch disc	(66)		
			 1878 000 968 ▽	380 10 380GTZ	624.333-334 Lose Kupplungsscheibe / Loose clutch disc	(39)		
			 3151 108 031	KZI-4,5	624.333-334			
			 1882 341 001	380 GF2/380	624.333-334 In 1888 enthalten / Contained in 1888	(29)		
			 1859 250 102	380 GF2/380	624.333-334 In 1888 enthalten / Contained in 1888	(29)		
			 1878 000 968 △	380 10 380GTZ	624.333-334 In 1888 enthalten / Contained in 1888	(29)		
				OM422.913	 1882 304 237	420 GF420N	624.333-334 für Nebenantrieb / for PTO	(82)
					 1878 003 269	420 10 420GTZ	624.333-334 für Nebenantrieb / for PTO	(82)
		 3151 204 001	KZI-6	624.333-334 für Nebenantrieb / for PTO mit Schmierrohranschluß / with lubricating pipe coupling	(82) (91)			
L,LK,LS 2628 343.033 343.044 343.034 343.031			 1800 125 301 ⊗ 1882 301 239 ⊗ 1878 002 706 ⊙ 3151 000 375	420 10 GF420 420GTZ KZIS-4				
			 3482 124 534 ●	430 GMF430				
2629								
2629 659.033 659.032 2629 659.032 2629 A 659.232/233 2629 A 659.233 659.232 2629 A 659.233 2629 A 659.233 2629 A 659.233 2629 A 659.233 2629 A 659.233 659.232	07.88 - 08.94	OM442	 3400 124 101 ⊗ 3482 081 232 ⊗ 1878 005 668 ⊙ 3151 000 549	430 10 MFZ430 430WGTZ KZISZ-5				
	07.88 - 08.94		 3400 122 501 ⊗ 3482 081 232 ⊗ 1878 634 027 ⊙ 3151 000 278	430 10 MFZ430 430WGTZ KZISZ-5	659.030/032-033/131-132/134 Sonderausführung / Special design	(56)		
	07.88 - 08.94		 3400 122 601 ⊗ 3482 081 231 ⊗ 1878 080 037 ⊙ 3151 000 278	430 10 MFZ430 430WGTZ KZISZ-5	659.232-233/333 Sonderausführung / Special design	(56)		
	07.88 - 08.94	OM442.925, OM442.959, OM440.970,	 1888 063 137	380 GF2/380N	für Nebenantrieb / for PTO enthält eine Kupplungsscheibe / This part number includes one clutch disc	(82) (66)		
	07.88 - 08.94	OM440.971, OM442.966, OM443.940,	 1862 304 033 ▽	380 10 380GV	für Nebenantrieb / for PTO Lose Kupplungsscheibe / Loose clutch disc	(82) (39)		
	07.88 - 08.94	OM442.906, OM402.982, OM442.929, OM442.926, OM442.997, OM442.917, OM442.907, OM442.989, OM442.942	 3151 166 031	KZI-6	für Nebenantrieb / for PTO	(82)		
			 1882 019 133	380 GF2/380N	In 1888 enthalten / Contained in 1888	(29)		
			 1859 250 101	380 GF2/380	In 1888 enthalten / Contained in 1888	(29)		
			 1862 305 033 △	380 10 380GVZ	In 1888 enthalten / Contained in 1888	(29)		
	2629 AK 659.334 659.333	07.88 - 08.94	OM442	 3400 124 101 ⊗ 3482 081 232 ⊗ 1878 005 668 ⊙ 3151 000 549	430 10 MFZ430 430WGTZ KZISZ-5			
	2629 AK 659.333	07.88 - 08.94		 3400 122 601 ⊗ 3482 081 231 ⊗ 1878 080 037 ⊙ 3151 000 278	430 10 MFZ430 430WGTZ KZISZ-5	659.232-233/333 Sonderausführung / Special design	(56)	
	2629 AK 659.333	07.88 - 08.94						
	2629 AK 659.334	07.88 - 08.94						

		CODE				
--	--	------	--	---	---	---

MERCEDES-BENZ











2629						
2629 AS 659.331	07.88-08.94	OM442		3400 124 101 ⊗ 3482 081 232 ⊗ 1878 005 668 ⊙ 3151 000 549	430 10 MFZ430 430WGTZ KZISZ-5	
2629 AS 659.331	07.88-08.94					
2629 B 659.030	07.88-08.94			3400 122 501 ⊗ 3482 081 232 ⊗ 1878 634 027 ⊙ 3151 000 278	430 10 MFZ430 430WGTZ KZISZ-5	659.030/032-033/131-132/134 Sonderausführung / Special design (56)
2629 K 659.132 659.134	07.88-08.94	OM442.925, OM442.906, OM401.979,		1888 063 137	380 GF2/380N	für Nebenantrieb / for PTO enthält eine Kupplungsscheibe / This part number includes one clutch disc (82) (66)
2629 K 659.134	07.88-08.94	OM442.929, OM442.926, OM442.997,		1862 304 033 ▽	380 10 380GV	für Nebenantrieb / for PTO Lose Kupplungsscheibe / Loose clutch disc (82) (39)
2629 K 659.134	07.88-08.94	OM442.917, OM442.907, OM442.989		3151 166 031	KZI-6	für Nebenantrieb / for PTO (82)
2629 S 659.131	07.88-08.94			1882 019 133	380 GF2/380N	In 1888 enthalten / Contained in 1888 (29)
				1859 250 101	380 GF2/380	In 1888 enthalten / Contained in 1888 (29)
				1862 305 033 △	380 10 380GVZ	In 1888 enthalten / Contained in 1888 (29)















2631						
2631 659.003 659.101/102 659.000 659.104 659.002	06.92-09.96	OM401, 441		3400 124 001 ⊗ 3482 081 231 ⊗ 1878 634 027 ⊙ 3151 000 278	430 10 MFZ430 430WGTZ KZISZ-5	
2631 659.102 659.002/003 659.101 659.104 659.000	06.92-09.96	OM401		1888 063 137	380 GF2/380N	für Nebenantrieb / for PTO enthält eine Kupplungsscheibe / This part number includes one clutch disc (82) (66)
2631 A 659.203	06.92-09.96			1862 304 033 ▽	380 10 380GV	für Nebenantrieb / for PTO Lose Kupplungsscheibe / Loose clutch disc (82) (39)
2631 A 659.203	01.94-09.96			3151 166 031	KZI-6	für Nebenantrieb / for PTO (82)
2631 AK, 2634 AK 659.303/304	06.92-09.96			1882 019 133	380 GF2/380N	In 1888 enthalten / Contained in 1888 (29)
2631 AK, 2634 AK 659.304 659.303	01.94-09.96			1859 250 101	380 GF2/380	In 1888 enthalten / Contained in 1888 (29)
2631 AS 659.301	06.92-09.96			1862 305 033 △	380 10 380GVZ	In 1888 enthalten / Contained in 1888 (29)
2631 B 659.000	06.92-09.96					
2631 S 659.101	06.92-09.96					
2631 S 659.101	06.92-09.96					
2631 K 659.104 659.134	07.88-08.94	OM401LA		3400 124 101 ⊗ 3482 081 232 ⊗ 1878 005 668 ⊙ 3151 000 549	430 10 MFZ430 430WGTZ KZISZ-5	



















2632						
2632 395.325/326	05.74-09.83	OM403		1800 125 301 ⊗ 1882 301 239 ⊗ 1878 002 706 ⊙ 3151 000 375	420 10 GF420 420GTZ KZIS-4	395.322/325-326/352/354/422/425/452-453-454
2632 A 395.425	05.74-09.83					
2632 AK 395.452-454	08.73-09.83			3482 124 534 ●	430 GMF430	395.322/325-326/352/354/422/425/452-453-454
2632 AS 395.422	05.74-09.83			1882 304 237	420 GF420N	395.425/452-453-454 für Nebenantrieb / for PTO (82)
2632 K 395.354 395.352	08.73-09.83			1862 268 031	420 10 420GVZ	395.425/452-453-454 für Nebenantrieb / for PTO (82)
2632 S 395.322	05.74-09.83	OM413		3482 124 522	430 GMF430	395.322/352/354/452-453-454 Sonderausführung / Special design (56)
				1878 634 016	420 10 420GSZ	395.322/352/354/452-453-454 Sonderausführung / Special design (56)
				1878 002 706 ●	420 10 420GTZ	395.322/352/354/452-453-454 Sonderausführung / Special design (56)
				3151 000 375	KZIS-4	395.322/352/354/452-453-454 Sonderausführung / Special design (56)

		CODE		 Parameter		
--	--	------	--	---	---	---

MERCEDES-BENZ





























2633						
2633 623.023 623.073 624.048 2633 S 624.196 624.146	05.82 - 05.87	OM422A, 423		1882 342 134	420 GF420X	
	05.82 - 05.87			1878 002 878	420 10 420GTZ	
				3151 110 031	KZI-4,5	
				1882 346 131 #	420 GF420XN	für Nebenantrieb / for PTO (82)
				1878 002 706	420 10 420GTZ	für Nebenantrieb / for PTO (82)
		OM422LA, 423		1888 042 009	380 GF2/380	enthält eine Kupplungsscheibe / This part number includes one clutch disc (66)
				1878 000 968 ▽	380 10 380GTZ	Lose Kupplungsscheibe / Loose clutch disc (39)
				3151 108 031	KZI-4,5	
				1882 341 001	380 GF2/380	In 1888 enthalten / Contained in 1888 (29)
			1859 250 102	380 GF2/380	In 1888 enthalten / Contained in 1888 (29)	
		1878 000 968 △	380 10 380GTZ	In 1888 enthalten / Contained in 1888 (29)		

2634						
2634 659.002	06.92 - 09.96	OM401, 441		3400 124 001  3482 081 231  1878 634 027  3151 000 278	430 10 MFZ430 430WGTZ KZISZ-5	
			OM401		1888 063 137	380 GF2/380N
				1862 304 033 ▽	380 10 380GV	für Nebenantrieb / for PTO Lose Kupplungsscheibe / Loose clutch disc (82) (39)
				3151 166 031	KZI-6	für Nebenantrieb / for PTO (82)
				1882 019 133	380 GF2/380N	In 1888 enthalten / Contained in 1888 (29)
				1859 250 101	380 GF2/380	In 1888 enthalten / Contained in 1888 (29)
			1862 305 033 △	380 10 380GVZ	In 1888 enthalten / Contained in 1888 (29)	
2634 S 659.101	06.92 - 09.96	OM401, 441		3400 124 001  3482 081 231  1878 634 027  3151 000 278	430 10 MFZ430 430WGTZ KZISZ-5	659.101/303

2635						
2635 658.019 659.038 2635 658.019 659.038 2635 659.038 658.019	07.88 - 08.94	OM442LA		3400 121 601  3488 017 432  1878 634 022  3151 000 547	400 10 MFZ2/400X 400GVZ KZISZ-5	->Chass. K011863
	07.88 - 08.94			3400 122 901  3482 081 233  1878 002 735  3151 000 278	430 10 MFZ430 430GTZ KZISZ-5	Chass. K011864->
	01.91 - 08.94	OM442A		3400 122 601  3482 081 231  1878 080 037  3151 000 278	430 10 MFZ430 430WGTZ KZISZ-5	658.019 659.038
	OM442.964, OM442.966, OM442.976, OM442.923, OM442.944, OM442.997, OM442.909			1888 063 137	380 GF2/380N	für Nebenantrieb / for PTO enthält eine Kupplungsscheibe / This part number includes one clutch disc (82) (66)
				1862 304 033 ▽	380 10 380GV	für Nebenantrieb / for PTO Lose Kupplungsscheibe / Loose clutch disc (82) (39)
				3151 166 031	KZI-6	für Nebenantrieb / for PTO (82)
				1882 019 133	380 GF2/380N	In 1888 enthalten / Contained in 1888 (29)
				1859 250 101	380 GF2/380	In 1888 enthalten / Contained in 1888 (29)
				1862 305 033 △	380 10 380GVZ	In 1888 enthalten / Contained in 1888 (29)









		CODE				
--	--	------	--	---	---	---













MERCEDES-BENZ



2635						
2635 649.038 648.013	04.86 - 03.91	OM422A, 442A		1888 055 041	380 GF2/380	649.038/136/186/237/336/338-339 enthält eine Kupplungsscheibe / This part number includes one clutch disc (66)
2635 A 649.237	09.87 - 03.91			1862 135 035 ▽	380 10 380GS	649.038/136/186/237/336/338-339 Lose Kupplungsscheibe / Loose clutch disc (39)
2635 AK 649.339 649.338	09.87 - 03.91			3151 108 031	KZI-4,5	649.038/136/186/237/336/338-339
2635 AS 649.336	09.87 - 03.91			1882 349 003	380 GF2/380	649.038/136/186/237/336/338-339 In 1888 enthalten / Contained in 1888 (29)
2635 S 649.186 649.136	04.86 - 03.91			1859 250 100	380 GF2/380	649.038/136/186/237/336/338-339 In 1888 enthalten / Contained in 1888 (29)
				1862 138 032 △	380 10 380GSZ	649.038/136/186/237/336/338-339 In 1888 enthalten / Contained in 1888 (29)
				1882 304 237	420 GF420N	649.237/336 für Nebenantrieb / for PTO (82)
				1878 003 269	420 10 420GTZ	649.237/336 für Nebenantrieb / for PTO (82)
				3151 204 001	KZI-6	649.237/336 für Nebenantrieb / for PTO mit Schmierrohranschluß / with lubricating pipe coupling (82) (91)
				1888 063 137	380 GF2/380N	649.038 für Nebenantrieb / for PTO enthält eine Kupplungsscheibe / This part number includes one clutch disc (82) (66)
				1862 304 033	380 10 380GV	649.038 für Nebenantrieb / for PTO (82)
				3151 204 001	KZI-6	649.038 für Nebenantrieb / for PTO mit Schmierrohranschluß / with lubricating pipe coupling (82) (91)
2635 A 659.237	02.90 - 08.94	OM442A		3400 122 601	430 10 MFZ430	
2635 A 659.237	12.91 - 08.94			 3482 081 231  1878 080 037  3151 000 278	430WGTZ KZISZ-5	
2635 AK 659.333 659.339 659.338	02.90 - 08.94			3400 121 601 HD	400 10 MFZ2/400X	für Fahrzeuge mit Zweischeibenkupplung / for vehicles with double disc clutch (77)
2635 AK 659.339 659.338	02.90 - 08.94			 3488 017 432  1878 634 022  3151 000 547	400GVZ KZISZ-5	
2635 AS 659.336	02.92 - 08.94	OM440.970, OM442.964, OM442.966,		1888 063 137	380 GF2/380N	für Nebenantrieb / for PTO enthält eine Kupplungsscheibe / This part number includes one clutch disc (82) (66)
2635 AS 659.336	02.90 - 09.96	OM402.971, OM440.971, OM440.973,		1862 304 033 ▽	380 10 380GV	für Nebenantrieb / for PTO Lose Kupplungsscheibe / Loose clutch disc (82) (39)
2635 K 659.137 659.139	07.88 - 08.94	OM440.942, OM442.944, OM442.972,		3151 166 031	KZI-6	für Nebenantrieb / for PTO (82)
2635 K 659.137	01.91 - 08.94	OM440.940, OM442.997,		1882 019 133	380 GF2/380N	In 1888 enthalten / Contained in 1888 (29)
2635 K 659.137	07.91 - 08.94	OM442.994, OM442.989, OM440.941, OM442.942		1859 250 101	380 GF2/380	In 1888 enthalten / Contained in 1888 (29)
2635 K 659.139	07.88 - 08.94			1862 305 033 △	380 10 380GVZ	In 1888 enthalten / Contained in 1888 (29)
2635 S 659.136 659.186	07.88 - 08.94					
2635 S 659.136	07.88 - 08.94					

		CODE					
--	--	------	--	--	---	---	---

MERCEDES-BENZ













2635							
2635 ,AK,L 659.333 656.215		OM442, 442A		3400 124 101 ⊗ 3482 081 232 ⊗ 1878 005 668 ⊙ 3151 000 549	430 10 MFZ430 430WGTZ KZISZ-5	656.215 659.333	
				3400 122 601 ⊗ 3482 081 231 ⊗ 1878 080 037 ⊙ 3151 000 278	430 10 MFZ430 430WGTZ KZISZ-5	659.333 Sonderausführung / Special design	(56)
			1888 063 137	380 GF2/380N	656.215 Nebenantriebs-ID / PTO ID: 4/125 enthält eine Kupplungsscheibe / This part number includes one clutch disc	(48) (66)	
			1862 304 033 ▽	380 10 380GV	656.215 Nebenantriebs-ID / PTO ID: 4/125 Lose Kupplungsscheibe / Loose clutch disc	(48) (39)	
			3151 166 031	KZI-6	656.215 Nebenantriebs-ID / PTO ID: 4/125	(48)	
			1882 019 133	380 GF2/380N	656.215 In 1888 enthalten / Contained in 1888	(29)	
			1859 250 101	380 GF2/380	656.215 In 1888 enthalten / Contained in 1888	(29)	
			1862 305 033 △	380 10 380GVZ	656.215 In 1888 enthalten / Contained in 1888	(29)	

2636							
2636 623.012 624.038 623.013 624.037 2636 A 624.237 2636 AK 624.339 624.338 2636 AS 624.336 2636 K 624.137 624.139 2636 S 624.136	11.81 - 03.91	OM422A, 423		1882 342 134	420 GF420X		
				1878 002 878	420 10 420GTZ		
				3151 110 031	KZI-4,5		
				1882 346 131 #	420 GF420XN	für Nebenantrieb / for PTO	(82)
				1878 002 706	420 10 420GTZ	für Nebenantrieb / for PTO	(82)
				3151 204 001	KZI-6	für Nebenantrieb / for PTO mit Schmierrohranschluß / with lubricating pipe coupling	(82) (91)
		OM422LA, 423		1888 042 009	380 GF2/380	enthält eine Kupplungsscheibe / This part number includes one clutch disc	(66)
				1878 000 968 ▽	380 10 380GTZ	Lose Kupplungsscheibe / Loose clutch disc	(39)
				3151 108 031	KZI-4,5		
				1882 341 001	380 GF2/380	In 1888 enthalten / Contained in 1888	(29)
				1859 250 102	380 GF2/380	In 1888 enthalten / Contained in 1888	(29)
				1878 000 968 △	380 10 380GTZ	In 1888 enthalten / Contained in 1888	(29)

2637							
2637 659.343		OM402		3400 122 601 ⊗ 3482 081 231 ⊗ 1878 080 037 ⊙ 3151 000 278	430 10 MFZ430 430WGTZ KZISZ-5		
				3400 121 601 ⊗ 3488 017 432 ⊗ 1878 634 022 ⊙ 3151 000 547	400 10 MFZ2/400X 400GVZ KZISZ-5	Sonderausführung / Special design	(56)
				3400 122 901 ⊗ 3482 081 233 ⊗ 1878 002 735 ⊙ 3151 000 278	430 10 MFZ430 430GTZ KZISZ-5	für / for: SA033617-01	(68)



















		CODE					
--	--	------	--	--	---	---	---



MERCEDES-BENZ

2638							
2638, 2638 L 659.028 659.142 659.197 659.144 659.147	09.91 - 09.96	OM402LA, 422LA		3400 122 601 ⊗ 3482 081 231 ⊗ 1878 080 037 ⊙ 3151 000 278	430 10 MFZ430 430WGTZ KZISZ-5		
2638, 2638 L 659.142 659.144 659.147 659.028 659.197	09.91 - 09.96			3400 122 901 ⊗ 3482 081 233 ⊗ 1878 002 735 ⊙ 3151 000 278	430 10 MFZ430 430GTZ KZISZ-5	für / for: SA033617-01	(68)
2638, 2638 L 659.028 659.142	09.91 - 09.96			3400 121 601 ⊗ 3488 017 432 ⊗ 1878 634 022 ⊙ 3151 000 547	400 10 MFZ2/400X 400GVZ KZISZ-5	für Fahrzeuge mit Zweis Scheibenkupplung / for vehicles with double disc clutch Sonderausführung / Special design	(77) (56)
2638 AK 659.343	09.91 - 09.96	OM402, 442LA		1888 063 137	380 GF2/380N	für Nebenantrieb / for PTO enthält eine Kupplungsscheibe / This part number includes one clutch disc	(82) (66)
2638 AS 659.341	07.92 - 09.96	OM440.970, OM440.978, OM402.985, OM446.926, OM446.925,		1862 304 033 ▽	380 10 380GV	für Nebenantrieb / for PTO Lose Kupplungsscheibe / Loose clutch disc	(82) (39)
2638 AS 659.341	01.94 - 09.96	OM440.981, OM446.927, OM446.925,		3151 166 031	KZI-6	für Nebenantrieb / for PTO	(82)
2638 AS 659.341	07.92 - 09.96	OM440.981, OM446.927, OM402.986, OM442.997, OM402.996, OM440.979, OM440.990, OM446.924, OM402.978, OM446.936, OM440.982, OM402.972, OM442.989		1882 019 133	380 GF2/380N	In 1888 enthalten / Contained in 1888	(29)
2638 AS 659.341	07.92 - 09.96	OM402.986, OM442.997, OM402.996, OM440.979, OM440.990, OM446.924, OM402.978, OM446.936, OM440.982, OM402.972, OM442.989		1859 250 101	380 GF2/380	In 1888 enthalten / Contained in 1888	(29)
2638 K 659.137 659.142 659.144 659.147	09.91 - 09.96	OM440.979, OM440.990, OM446.924, OM402.978, OM446.936, OM440.982, OM402.972, OM442.989		1862 305 033 △	380 10 380GVZ	In 1888 enthalten / Contained in 1888	(29)
2638 K 659.147 659.142 659.144	09.91 - 09.96	OM440.979, OM440.990, OM446.924, OM402.978, OM446.936, OM440.982, OM402.972, OM442.989					
2638 K 659.142 659.147 659.144	09.91 - 09.96	OM440.979, OM440.990, OM446.924, OM402.978, OM446.936, OM440.982, OM402.972, OM442.989					
2638 K 659.144 659.147 659.142	09.91 - 09.96	OM440.979, OM440.990, OM446.924, OM402.978, OM446.936, OM440.982, OM402.972, OM442.989					
2638 K 659.142 659.144 659.147	09.91 - 09.96	OM440.979, OM440.990, OM446.924, OM402.978, OM446.936, OM440.982, OM402.972, OM442.989					
2638 S 659.197	09.91 - 09.96	OM440.979, OM440.990, OM446.924, OM402.978, OM446.936, OM440.982, OM402.972, OM442.989					
2638 S 659.197	09.91 - 09.96	OM440.979, OM440.990, OM446.924, OM402.978, OM446.936, OM440.982, OM402.972, OM442.989					
2638 A, LA 659.242	09.91 - 09.96	OM402.975, OM446.927, OM402.996, OM402.978		3400 122 601 ⊗ 3482 081 231 ⊗ 1878 080 037 ⊙ 3151 000 278	430 10 MFZ430 430WGTZ KZISZ-5		
2638 A, LA 659.242	09.91 - 09.96	OM402.975, OM446.927, OM402.996, OM402.978		3400 121 601 ⊗ 3488 017 432 ⊗ 1878 634 022 ⊙ 3151 000 547	400 10 MFZ2/400X 400GVZ KZISZ-5	für Fahrzeuge mit Zweis Scheibenkupplung / for vehicles with double disc clutch	(77)
2638 A, LA 659.242	09.91 - 09.96	OM440.970, OM440.979		3400 121 601 ⊗ 3488 017 432 ⊗ 1878 634 022 ⊙ 3151 000 547	400 10 MFZ2/400X 400GVZ KZISZ-5	für Fahrzeuge mit Zweis Scheibenkupplung / for vehicles with double disc clutch	(77)

		CODE				
--	--	------	--	---	---	---



























































MERCEDES-BENZ

2638								
2638 AK 659.343/344 2638 AK 659.344 659.343 2638 AK 659.343/344	07.92 - 09.96	OM402LA, 422LA		3400 122 601 ● 3482 081 231 ● 1878 080 037 ● 3151 000 278	430 10 MFZ430 430WGTZ KZISZ-5			
	01.94 - 09.96							
	07.92 - 09.96			3400 122 901 ● 3482 081 233 ● 1878 002 735 ● 3151 000 278	430 10 MFZ430 430GTZ KZISZ-5	für / for: SA033617-01	(68)	
			OM402, 442LA		3400 121 601 ● 3488 017 432 ● 1878 634 022 ● 3151 000 547	400 10 MFZ2/400X 400GVZ KZISZ-5	für Fahrzeuge mit Zweischeibenkupplung / for vehicles with double disc clutch Sonderausführung / Special design	(77) (56)
			OM402.975, OM440.970, OM446.927, OM402.996, OM440.979, OM402.978, OM446.936		1888 063 137	380 GF2/380N	für Nebenantrieb / for PTO enthält eine Kupplungsscheibe / This part number includes one clutch disc	(82) (66)
					1862 304 033 ▽	380 10 380GV	für Nebenantrieb / for PTO Lose Kupplungsscheibe / Loose clutch disc	(82) (39)
					3151 166 031	KZI-6	für Nebenantrieb / for PTO	(82)
					1882 019 133	380 GF2/380N	In 1888 enthalten / Contained in 1888	(29)
					1859 250 101	380 GF2/380	In 1888 enthalten / Contained in 1888	(29)
					1862 305 033 △	380 10 380GVZ	In 1888 enthalten / Contained in 1888	(29)
				3483 023 032 ⊕	445 GMFZ445W	659.344 für Fahrzeuge mit Wandlerschaltkupplung / for vehicles with converter and clutch unit	(76)	
				1878 003 780	445 24 445GTZ	659.344 für Fahrzeuge mit Wandlerschaltkupplung / for vehicles with converter and clutch unit	(76)	
2638 S 624.191 2638 623.068	01.81 - 12.86	OM422LA		1888 042 009	380 GF2/380	enthält eine Kupplungsscheibe / This part number includes one clutch disc	(66)	
	01.81 - 12.86				1878 000 968 ▽	380 10 380GTZ	Lose Kupplungsscheibe / Loose clutch disc	(39)
					3151 108 031	KZI-4,5		
					1882 341 001	380 GF2/380	In 1888 enthalten / Contained in 1888	(29)
					1859 250 102	380 GF2/380	In 1888 enthalten / Contained in 1888	(29)
					1878 000 968 △	380 10 380GTZ	In 1888 enthalten / Contained in 1888	(29)
2638, L, LK, LS 696.367 696.369 696.365				3400 700 355 ⊕ ● 3488 000 158 ● 1878 002 019	400 18 MFZ2/400X 400WGTZ	für / for: Lateinamerika	(68)	
					3100 000 003	KZISZ-5	für / for: Lateinamerika mit Zubehör / with accessories Beinhaltet Ausrücker und Montagesatz / Contains releaser and fitting kit In 3488 enthalten / Contained in 3488	(68) (94) (14) (31)

2644						
2644, 2644 L 659.191 659.093 659.147 659.028 2644 S 659.191	01.92 - 09.96	OM440		3400 121 601 ● 3488 017 432 ● 1878 634 022 ● 3151 000 547	400 10 MFZ2/400X 400GVZ KZISZ-5	->Chass. K011863 659.093/191
	01.92 - 09.96			3400 122 901 ● 3482 081 233 ● 1878 002 735 ● 3151 000 278	430 10 MFZ430 430GTZ KZISZ-5	Chass. K011864-> 659.093/191

		CODE				
--	--	------	--	---	---	---











MERCEDES-BENZ

2644						
2644 ,K,AK 659.142 659.147 659.137 659.344 659.343		OM402, 442LA	 3400 122 601  3482 081 231  1878 080 037  3151 000 278	430 10 MFZ430 430WGTZ KZISZ-5		
			 3400 122 901  3482 081 233  1878 002 735  3151 000 278	430 10 MFZ430 430GTZ KZISZ-5	für / for: SA033617-01	(68)
			 3400 121 601  3488 017 432  1878 634 022  3151 000 547	400 10 MFZ2/400X 400GVZ KZISZ-5	659.344 für Fahrzeuge mit Zweischeibenkupplung / for vehicles with double disc clutch	(77)
		 3483 023 032 ⊕	445 GMFZ445W	659.344 für Fahrzeuge mit Wandlerschaltkupplung / for vehicles with converter and clutch unit	(76)	
		 1878 003 780	445 24 445GTZ	659.344 für Fahrzeuge mit Wandlerschaltkupplung / for vehicles with converter and clutch unit	(76)	
2644 A 659.242	01.92 - 09.96	OM440.970, OM440.979, OM446.936	 3400 122 601  3482 081 231  1878 080 037  3151 000 278	430 10 MFZ430 430WGTZ KZISZ-5		
			 3400 122 901  3482 081 233  1878 002 735  3151 000 278	430 10 MFZ430 430GTZ KZISZ-5	für / for: SA033617-01	(68)
			 3400 121 601  3488 017 432  1878 634 022  3151 000 547	400 10 MFZ2/400X 400GVZ KZISZ-5	für Fahrzeuge mit Zweischeibenkupplung / for vehicles with double disc clutch	(77)
2644 AK 659.343/344			 3400 122 601  3482 081 231  1878 080 037  3151 000 278	430 10 MFZ430 430WGTZ KZISZ-5	659.344	
			 3400 121 601  3488 017 432  1878 634 022  3151 000 547	400 10 MFZ2/400X 400GVZ KZISZ-5	659.344 für Fahrzeuge mit Zweischeibenkupplung / for vehicles with double disc clutch	(77)
			 3483 023 032 ⊕	445 GMFZ445W	659.344 für Fahrzeuge mit Wandlerschaltkupplung / for vehicles with converter and clutch unit	(76)
			 1878 003 780	445 24 445GTZ	659.344 für Fahrzeuge mit Wandlerschaltkupplung / for vehicles with converter and clutch unit	(76)
2644 AK 659.333		OM442LA	 3400 124 101  3482 081 232  1878 005 668  3151 000 549	430 10 MFZ430 430WGTZ KZISZ-5		
			 3400 122 601  3482 081 231  1878 080 037  3151 000 278	430 10 MFZ430 430WGTZ KZISZ-5	Sonderausführung / Special design	(56)
2644 S 649.196	10.85 - 02.90	OM442LA	 1888 055 247	380 GF2/380	enthält eine Kupplungsscheibe / This part number includes one clutch disc	(66)
			 1862 123 131 ▽	380 10 380GV	Lose Kupplungsscheibe / Loose clutch disc	(39)
			 3151 108 031	KZI-4,5		
			 1882 349 003	380 GF2/380	In 1888 enthalten / Contained in 1888	(29)
			 1859 250 100	380 GF2/380	In 1888 enthalten / Contained in 1888	(29)
 1862 122 132 △	380 10 380GVZ	In 1888 enthalten / Contained in 1888	(29)			
2645						
2645 AS 659.336	02.90 - 09.96	OM442.989	 3400 122 601  3482 081 231  1878 080 037  3151 000 278	430 10 MFZ430 430WGTZ KZISZ-5		
2648						
2648 AK 659.338	02.90 - 08.94	OM440.973, OM442.989	 3400 122 601  3482 081 231  1878 080 037  3151 000 278	430 10 MFZ430 430WGTZ KZISZ-5		













		CODE				
--	--	------	--	---	---	---

MERCEDES-BENZ

2648







2648 AS 659.331 2648 K,AS 659.331 659.134	07.88-08.94	OM442LA	 3400 124 101 ⊗ 3482 081 232 ⊗ 1878 005 668 ⊙ 3151 000 549	430 10 MFZ430 430WGTZ KZISZ-5		
2648 S 659.196 2648 S 659.196	12.88-07.92 12.88-07.92	OM440	 3400 121 601 ⊗ 3488 017 432 ⊗ 1878 634 022 ⊙ 3151 000 547	400 10 MFZ2/400X 400GVZ KZISZ-5	->Chass. K011863	
			 3400 122 901 ⊗ 3482 081 233 ⊗ 1878 002 735 ⊙ 3151 000 278	430 10 MFZ430 430GTZ KZISZ-5	Chass. K011864->	
		OM442LA	 3400 121 601 ⊗ 3488 017 432 ⊗ 1878 634 022 ⊙ 3151 000 547	400 10 MFZ2/400X 400GVZ KZISZ-5		
		OM442.983, OM442.985, OM442.992, OM442.994, OM442.989	 3483 023 032 ⊕	445 GMFZ445W	für Fahrzeuge mit Wandlerschaltkupplung / for vehicles with converter and clutch unit	(76)
			 1878 003 780	445 24 445GTZ	für Fahrzeuge mit Wandlerschaltkupplung / for vehicles with converter and clutch unit	(76)
2648 S,AS,AK 659.338 659.336 659.136		OM442LA	 3400 122 601 ⊗ 3482 081 231 ⊗ 1878 080 037 ⊙ 3151 000 278	430 10 MFZ430 430WGTZ KZISZ-5		
2648 S,LS 659.196		OM440	 3400 121 601 ⊗ 3488 017 432 ⊗ 1878 634 022 ⊙ 3151 000 547	400 10 MFZ2/400X 400GVZ KZISZ-5	->Chass. K011863	
			 3400 122 901 ⊗ 3482 081 233 ⊗ 1878 002 735 ⊙ 3151 000 278	430 10 MFZ430 430GTZ KZISZ-5	Chass. K011864->	
			 3483 023 032 ⊕	445 GMFZ445W	für Fahrzeuge mit Wandlerschaltkupplung / for vehicles with converter and clutch unit	(76)
			 1878 003 780	445 24 445GTZ	für Fahrzeuge mit Wandlerschaltkupplung / for vehicles with converter and clutch unit	(76)









2650





2650 656.215			 1888 063 137	380 GF2/380N	Nebenantriebs-ID / PTO ID: 4/125 enthält eine Kupplungsscheibe / This part number includes one clutch disc	(48) (66)
			 1862 304 033 ▽	380 10 380GV	Nebenantriebs-ID / PTO ID: 4/125 Lose Kupplungsscheibe / Loose clutch disc	(48) (39)
			 3151 166 031	KZI-6	Nebenantriebs-ID / PTO ID: 4/125	(48)
			 1882 019 133	380 GF2/380N	In 1888 enthalten / Contained in 1888	(29)
			 1859 250 101	380 GF2/380	In 1888 enthalten / Contained in 1888	(29)
			 1862 305 033 △	380 10 380GVZ	In 1888 enthalten / Contained in 1888	(29)
2650, 2650 L 659.098 659.144 659.028 659.142 655.496	07.92-09.96	OM442, 442LA	 3400 121 601 ⊗ 3488 017 432 ⊗ 1878 634 022 ⊙ 3151 000 547	400 10 MFZ2/400X 400GVZ KZISZ-5	->Chass. K011863 659.098/196 655.496	
			 3400 122 901 ⊗ 3482 081 233 ⊗ 1878 002 735 ⊙ 3151 000 278	430 10 MFZ430 430GTZ KZISZ-5	Chass. K011864-> 659.098/196 655.496	
		OM442LA	 3400 121 601 ⊗ 3488 017 432 ⊗ 1878 634 022 ⊙ 3151 000 547	400 10 MFZ2/400X 400GVZ KZISZ-5	für / for: SA33613-03	(68)
2650 ,K,S,AK 625.197 659.139 659.142 659.339 659.144 659.136		OM402, 442LA	 3400 122 601 ⊗ 3482 081 231 ⊗ 1878 080 037 ⊙ 3151 000 278	430 10 MFZ430 430WGTZ KZISZ-5	659.136/139/142/144/339 625.197	
			 3400 122 901 ⊗ 3482 081 233 ⊗ 1878 002 735 ⊙ 3151 000 278	430 10 MFZ430 430GTZ KZISZ-5	für / for: SA033617-01 659.142/144	(68)
2650 A,AS 659.334 659.142 659.144 659.232 659.331		OM442, 442LA	 3400 124 101	430 10		
			 3400 122 601	430 10	659.232	

		CODE					
--	--	------	--	--	---	---	---

MERCEDES-BENZ

















2650							
2650 K 659.139	07.88 - 08.94	OM442.997, OM442.994, OM442.989		3400 122 601 ⊗ 3482 081 231 ⊗ 1878 080 037 ⊙ 3151 000 278	430 10 MFZ430 430WGTZ KZISZ-5		
2650 S 659.196	07.92 - 09.96	OM442, 442LA		3400 121 601 ⊗ 3488 017 432 ⊗ 1878 634 022 ⊙ 3151 000 547	400 10 MFZ2/400X 400GVZ KZISZ-5	->Chass. K011863 659.098/196 655.496	
				3400 122 901 ⊗ 3482 081 233 ⊗ 1878 002 735 ⊙ 3151 000 278	430 10 MFZ430 430GTZ KZISZ-5	Chass. K011864-> 659.098/196 655.496	
		OM442LA		3400 121 601 ⊗ 3488 017 432 ⊗ 1878 634 022 ⊙ 3151 000 547	400 10 MFZ2/400X 400GVZ KZISZ-5	für / for: SA33613-03	(68)
		OM440.971, OM440.973, OM442.997		3483 023 032 ⊕	445 GMFZ445W	für Fahrzeuge mit Wandlerschaltkupplung / for vehicles with converter and clutch unit	(76)
				1878 003 780	445 24 445GTZ	für Fahrzeuge mit Wandlerschaltkupplung / for vehicles with converter and clutch unit	(76)

2653							
2653 , 2653 L 659.098 659.028 659.196	09.95 - 09.96	OM446.920		3483 023 032 ⊕	445 GMFZ445W	659.196 für Fahrzeuge mit Wandlerschaltkupplung / for vehicles with converter and clutch unit	(76)
				1878 003 780	445 24 445GTZ	659.196 für Fahrzeuge mit Wandlerschaltkupplung / for vehicles with converter and clutch unit	(76)
2653 AK,K,S 659.344 659.142 659.343				3400 122 601 ⊗ 3482 081 231 ⊗ 1878 080 037 ⊙ 3151 000 278	430 10 MFZ430 430WGTZ KZISZ-5	659.344	
				3400 121 601 ⊗ 3488 017 432 ⊗ 1878 634 022 ⊙ 3151 000 547	400 10 MFZ2/400X 400GVZ KZISZ-5	659.344 für Fahrzeuge mit Zweischeibenkupplung / for vehicles with double disc clutch	(77)
				3483 023 032 ⊕	445 GMFZ445W	659.344 für Fahrzeuge mit Wandlerschaltkupplung / for vehicles with converter and clutch unit	(76)
				1878 003 780	445 24 445GTZ	659.344 für Fahrzeuge mit Wandlerschaltkupplung / for vehicles with converter and clutch unit	(76)
2653 AK 659.344	07.92 - 09.96	OM446.946		3483 023 032 ⊕	445 GMFZ445W	659.344 für Fahrzeuge mit Wandlerschaltkupplung / for vehicles with converter and clutch unit	(76)
				1878 003 780	445 24 445GTZ	659.344 für Fahrzeuge mit Wandlerschaltkupplung / for vehicles with converter and clutch unit	(76)

3025							
3025 B 625.005 3025 K 625.009	12.85 - 07.87	OM422.920, OM422.919		1800 125 301 ⊗ 1882 301 239 ⊗ 1878 002 706 ⊙ 3151 000 375	420 10 GF420 420GTZ KZIS-4		
	12.85 - 07.87			3482 124 534 ●	430 GMF430		
				1882 304 237	420 GF420N	625.005/009 für Nebenantrieb / for PTO	(82)
				1862 268 031	420 10 420GVZ	625.005/009 für Nebenantrieb / for PTO	(82)
				3151 204 001	KZI-6	625.005/009 für Nebenantrieb / for PTO mit Schmierrohranschluß / with lubricating pipe coupling	(82) (91)























		CODE		 Parameter		
--	--	------	--	---	---	---

MERCEDES-BENZ

3028						
3028 B 625.016 625.015	12.85 - 07.87	OM422.919	 1800 125 301 ⊗ 1882 301 239 ⊗ 1878 002 706 ⊙ 3151 000 375	420 10 GF420 420GTZ KZIS-4		
			 3482 124 534 ●	430 GMF430		
			 1882 304 237	420 GF420N	für Nebenantrieb / for PTO	(82)
			 1862 268 031	420 10 420GVZ	für Nebenantrieb / for PTO	(82)
3028 K 625.018/019	12.85 - 07.87	OM422.919	 1800 125 301 ⊗ 1882 301 239 ⊗ 1878 002 706 ⊙ 3151 000 375	420 10 GF420 420GTZ KZIS-4		
			 3482 124 534 ●	430 GMF430		
			 1882 304 237	420 GF420N	625.018 für Nebenantrieb / for PTO	(82)
			 1862 268 031	420 10 420GVZ	625.018 für Nebenantrieb / for PTO	(82)
			 3151 204 001	KZI-6	625.018 für Nebenantrieb / for PTO mit Schmierrohranschluß / with lubricating pipe coupling	(82) (91)
3028 623.009	02.80 - 03.91	OM422	 1800 125 301 ⊗ 1882 301 239 ⊗ 1878 002 706 ⊙ 3151 000 375	420 10 GF420 420GTZ KZIS-4		
			 3482 124 534 ●	430 GMF430		
3033						
3033 623.023	05.82 - 05.87	OM422A, 423	 1882 342 134	420 GF420X		
			 1878 002 878	420 10 420GTZ		
			 3151 110 031	KZI-4,5		
3035						
3035 K 648.038			 1888 063 137	380 GF2/380N	648.038 für Nebenantrieb / for PTO enthält eine Kupplungsscheibe / This part number includes one clutch disc	(82) (66)
			 1862 304 033	380 10 380GV	648.038 für Nebenantrieb / for PTO	(82)
			 3151 204 001	KZI-6	648.038 für Nebenantrieb / for PTO mit Schmierrohranschluß / with lubricating pipe coupling	(82) (91)







		CODE				
--	--	------	--	---	---	---







MERCEDES-BENZ



3036								
3036 K 624.237 623.012		OM422A, 423	 1882 342 134	420 GF420X	623.012 624.237			
			 1878 002 878	420 10 420GTZ	623.012 624.237			
			 3151 110 031	KZI-4,5	623.012 624.237			
		OM422LA, 423			 1888 042 009	380 GF2/380	624.237 enthält eine Kupplungsscheibe / This part number includes one clutch disc Sonderausführung / Special design	(66) (56)
					 1878 000 968 ▽	380 10 380GTZ	624.237 Sonderausführung / Special design Lose Kupplungsscheibe / Loose clutch disc	(56) (39)
					 3151 108 031	KZI-4,5	624.237 Sonderausführung / Special design	(56)
					 1882 341 001	380 GF2/380	624.237 In 1888 enthalten / Contained in 1888 Sonderausführung / Special design	(29) (56)
					 1859 250 102	380 GF2/380	624.237 In 1888 enthalten / Contained in 1888 Sonderausführung / Special design	(29) (56)
					 1878 000 968 △	380 10 380GTZ	624.237 Sonderausführung / Special design In 1888 enthalten / Contained in 1888	(56) (29)
					 1882 346 131 #	420 GF420XN	624.237 für Nebenantrieb / for PTO	(82)
					 1878 002 706	420 10 420GTZ	624.237 für Nebenantrieb / for PTO	(82)
					 3151 204 001	KZI-6	624.237 für Nebenantrieb / for PTO mit Schmierrohranschluß / with lubricating pipe coupling	(82) (91)
					3036 623.012	11.81 - 03.91	OM422A, 423	 1882 342 134
 1878 002 878	420 10 420GTZ	623.012 624.237						
 3151 110 031	KZI-4,5	623.012 624.237						
OM422LA, 423			 1888 042 009	380 GF2/380			624.237 enthält eine Kupplungsscheibe / This part number includes one clutch disc Sonderausführung / Special design	(66) (56)
			 1878 000 968 ▽	380 10 380GTZ			624.237 Sonderausführung / Special design Lose Kupplungsscheibe / Loose clutch disc	(56) (39)
			 3151 108 031	KZI-4,5			624.237 Sonderausführung / Special design	(56)
			 1882 341 001	380 GF2/380			624.237 In 1888 enthalten / Contained in 1888 Sonderausführung / Special design	(29) (56)
			 1859 250 102	380 GF2/380			624.237 In 1888 enthalten / Contained in 1888 Sonderausführung / Special design	(29) (56)
			 1878 000 968 △	380 10 380GTZ			624.237 Sonderausführung / Special design In 1888 enthalten / Contained in 1888	(56) (29)
			 1878 002 706	420 10 420GTZ			623.012 für Nebenantrieb / for PTO	(82)
			 3151 204 001	KZI-6			623.012 für Nebenantrieb / for PTO mit Schmierrohranschluß / with lubricating pipe coupling	(82) (91)





		CODE					
--	--	------	--	--	---	---	---

MERCEDES-BENZ

3038							
3038 623.068	01.81 - 12.86	OM422LA		1888 042 009	380 GF2/380	623.068 enthält eine Kupplungsscheibe / This part number includes one clutch disc	(66)
3038 623.068				1878 000 968 ▽	380 10 380GTZ	623.068 Lose Kupplungsscheibe / Loose clutch disc	(39)
				3151 108 031	KZI-4,5	623.068	
				1882 341 001	380 GF2/380	623.068 In 1888 enthalten / Contained in 1888	(29)
				1859 250 102	380 GF2/380	623.068 In 1888 enthalten / Contained in 1888	(29)
				1878 000 968 △	380 10 380GTZ	623.068 In 1888 enthalten / Contained in 1888	(29)

3050							
3050 625.036/037 3050 ,S 625.197 625.036/037 625.196	01.94 - 09.96	OM442LA		3400 122 601 ⊙ 3482 081 231 ⊙ 1878 080 037 ⊙ 3151 000 278	430 10 MFZ430 430WGTZ KZISZ-5	625.036-037/196-197	
		OM446.933		3483 023 032 ⊕	445 GMFZ445W	625.036-037 für Fahrzeuge mit Wandlerschaltkupplung / for vehicles with converter and clutch unit	(76)
				1878 003 780	445 24 445GTZ	625.036-037 für Fahrzeuge mit Wandlerschaltkupplung / for vehicles with converter and clutch unit	(76)
3053 S 625.037	12.93 - 09.96	OM442LA		3400 122 601 ⊙ 3482 081 231 ⊙ 1878 080 037 ⊙ 3151 000 278	430 10 MFZ430 430WGTZ KZISZ-5	625.036-037/196-197	
		OM440.976		3483 023 032 ⊕	445 GMFZ445W	625.037 für Fahrzeuge mit Wandlerschaltkupplung / for vehicles with converter and clutch unit	(76)
					1878 003 780	445 24 445GTZ	625.037 für Fahrzeuge mit Wandlerschaltkupplung / for vehicles with converter and clutch unit





















3053							
3053 ,A 625.037		OM442LA		3400 122 601 ⊙ 3482 081 231 ⊙ 1878 080 037 ⊙ 3151 000 278	430 10 MFZ430 430WGTZ KZISZ-5	625.037	
				3483 023 032 ⊕	445 GMFZ445W	625.037 für Fahrzeuge mit Wandlerschaltkupplung / for vehicles with converter and clutch unit	(76)
					1878 003 780	445 24 445GTZ	625.037 für Fahrzeuge mit Wandlerschaltkupplung / for vehicles with converter and clutch unit

3228							
3228 B 625.005 3228 K 625.009 625.019 625.018	07.87 - 03.91	OM422		1800 125 301 ⊙ 1882 301 239 ⊙ 1878 002 706 ⊙ 3151 000 375	420 10 GF420 420GTZ KZIS-4	625.005/009/018-019	
	07.87 - 03.91			3482 124 534 ●	430 GMF430	625.005/009/018-019	
				1882 304 237	420 GF420N	625.005/009/018 für Nebenantrieb / for PTO	(82)
				1878 003 269	420 10 420GTZ	625.005/009/018 für Nebenantrieb / for PTO	(82)
				3151 204 001	KZI-6	625.005/009/018 für Nebenantrieb / for PTO mit Schmierrohranschluß / with lubricating pipe coupling	(82) (91)

3229							
3229 625.101 3229 B 625.105 3229 K 625.108	09.89 - 08.94	OM441, 442		3400 124 101 ⊙ 3482 081 232 ⊙ 1878 005 668 ⊙ 3151 000 549	430 10 MFZ430 430WGTZ KZISZ-5	625.101/105/108	
	09.89 - 07.92						
	09.89 - 01.92						















		CODE				
--	--	------	--	---	---	---

MERCEDES-BENZ

3231							
3231 L 653.452 653.454	12.87 - 09.96	OM401LA, 441LA		3400 124 001 ⊗ 3482 081 231 ⊗ 1878 634 027 ⊙ 3151 000 278	430 10 MFZ430 430WGTZ KZISZ-5	653.452/454	
3231 L 653.452 653.454	12.87 - 09.96						
3233							
3233 ,B 625.005		OM441A, LA		1800 125 301 ⊗ 1882 301 239 ⊗ 1878 002 706 ⊙ 3151 000 375	420 10 GF420 420GTZ KZIS-4	625.005	
				3482 124 534 ●	430 GMF430	625.005	
				1882 304 237	420 GF420N	625.005 für Nebenantrieb / for PTO	(82)
				1878 003 269	420 10 420GTZ	625.005 für Nebenantrieb / for PTO	(82)
				3151 204 001	KZI-6	625.005 für Nebenantrieb / for PTO mit Schmierrohranschluß / with lubricating pipe coupling	(82) (91)
3233 B 625.115	10.90 - 07.92	OM441.982, OM441.985		3400 124 001 ⊗ 3482 081 231 ⊗ 1878 634 027 ⊙ 3151 000 278	430 10 MFZ430 430WGTZ KZISZ-5		
3233 K 625.118	10.90 - 07.92						
3234							
3234 B 625.115	02.92 - 09.96	OM441LA		3400 124 001 ⊗ 3482 081 231 ⊗ 1878 634 027 ⊙ 3151 000 278	430 10 MFZ430 430WGTZ KZISZ-5	625.115/118-119 653.463-464	
				1888 063 137	380 GF2/380N	625.115 Nebenantriebs-ID / PTO ID: NMV-4 enthält eine Kupplungsscheibe / This part number includes one clutch disc	(48) (66)
				1862 304 033	380 10 380GV	625.115 Nebenantriebs-ID / PTO ID: NMV-4	(48)
				3151 166 031	KZI-6	625.115 Nebenantriebs-ID / PTO ID: NMV-4	(48)
3234 K 625.118/119	02.92 - 09.96	OM441LA		3400 124 001 ⊗ 3482 081 231 ⊗ 1878 634 027 ⊙ 3151 000 278	430 10 MFZ430 430WGTZ KZISZ-5	625.115/118-119 653.463-464	
3235							
3235 625.121 625.120	10.88 - 07.92	OM442A		3400 122 601 ⊗ 3482 081 231 ⊗ 1878 080 037 ⊙ 3151 000 278	430 10 MFZ430 430WGTZ KZISZ-5	625.120-121/128 658.019	
				3400 121 601 ⊗ 3488 017 432 ⊗ 1878 634 022 ⊙ 3151 000 547	400 10 MFZ2/400X 400GVZ KZISZ-5	625.120-121/128 Sonderausführung / Special design	(56)
				1888 063 137	380 GF2/380N	625.120-121/128 für Nebenantrieb / for PTO enthält eine Kupplungsscheibe / This part number includes one clutch disc	(82) (66)
				1862 304 033 ▽	380 10 380GV	625.120-121/128 für Nebenantrieb / for PTO Lose Kupplungsscheibe / Loose clutch disc	(82) (39)
				3151 166 031	KZI-6	625.120-121/128 für Nebenantrieb / for PTO	(82)
				1882 019 133	380 GF2/380N	625.120-121/128 In 1888 enthalten / Contained in 1888	(29)
				1859 250 101	380 GF2/380	625.120-121/128 In 1888 enthalten / Contained in 1888	(29)
				1862 305 033 △	380 10 380GVZ	625.120-121/128 In 1888 enthalten / Contained in 1888	(29)
3235 658.013 658.063 658.019	07.88 - 08.94	OM442A		3400 122 601 ⊗ 3482 081 231 ⊗ 1878 080 037 ⊙ 3151 000 278	430 10 MFZ430 430WGTZ KZISZ-5	658.013/019/038/063/413	
3235 658.038	07.88 - 08.94						
3235 L 658.413	07.87 - 09.96						



















		CODE					
--	--	------	--	--	---	---	---























MERCEDES-BENZ









3235							
3235 K 625.018/019 625.120	07.87 - 07.92	OM442A		3400 122 601 3482 081 231 1878 080 037 3151 000 278	430 10 MFZ430 430WGTZ KZISZ-5	01.1988-> 625.120-121/128	
				3400 121 601 3488 017 432 1878 634 022 3151 000 547	400 10 MFZ2/400X 400GVZ KZISZ-5	01.1988-> 625.120-121/128 Sonderausführung / Special design	(56)
				1800 125 301 1882 301 239 1878 002 706 3151 000 375	420 10 GF420 420GTZ KZIS-4	625.018-019	
				3482 124 534 ●	430 GMF430	625.018-019	
				1888 063 137	380 GF2/380N	01.1988-> 625.120-121/128 für Nebenantrieb / for PTO enthält eine Kupplungsscheibe / This part number includes one clutch disc	(82) (66)
				1862 304 033 ▽	380 10 380GV	01.1988-> 625.120-121/128 für Nebenantrieb / for PTO Lose Kupplungsscheibe / Loose clutch disc	(82) (39)
				3151 166 031	KZI-6	01.1988-> 625.120-121/128 für Nebenantrieb / for PTO	(82)
				1882 019 133	380 GF2/380N	01.1988-> 625.120-121/128 In 1888 enthalten / Contained in 1888	(29)
				1859 250 101	380 GF2/380	01.1988-> 625.120-121/128 In 1888 enthalten / Contained in 1888	(29)
				1862 305 033 △	380 10 380GVZ	01.1988-> 625.120-121/128 In 1888 enthalten / Contained in 1888	(29)
				1882 304 237	420 GF420N	625.018-019 für Nebenantrieb / for PTO	(82)
				1878 003 269	420 10 420GTZ	625.018-019 für Nebenantrieb / for PTO	(82)
				3151 204 001	KZI-6	625.018-019 für Nebenantrieb / for PTO mit Schmierrohranschluß / with lubricating pipe coupling	(82) (91)
3236							
3236 A 625.374	01.85 -			3483 023 001 ⊕	445 GMFZ445W	für Fahrzeuge mit Wandlerschaltkupplung / for vehicles with converter and clutch unit	(76)
				1878 051 801	445 24 445GTZC	für Fahrzeuge mit Wandlerschaltkupplung / for vehicles with converter and clutch unit	(76)

		CODE				
--	--	------	--	---	---	---

MERCEDES-BENZ





3238								
3238 658.043 3238 625.132 625.131 625.130 3238 658.043 3238 658.043 3238 625.130-132 3238, 3238 L 625.132 658.024 625.131 625.130 3238, 3238 L 625.130-132	03.91 - 09.96	OM402LA, 423, 442LA		3400 122 601  3482 081 231  1878 080 037  3151 000 278	430 10 MFZ430 430WGTZ KZISZ-5	625.130-131-132 658.024/043		
	10.90 - 09.96			3400 122 901  3482 081 233  1878 002 735  3151 000 278	430 10 MFZ430 430GTZ KZISZ-5	für / for: SA033617-01 625.130-131-132 658.024/043	(68)	
	03.91 - 09.96	OM442LA		3400 121 601 HD  3488 017 432  1878 634 022  3151 000 547	400 10 MFZ2/400X 400GVZ KZISZ-5	für / for: SA/W25801/03 für Fahrzeuge mit Zweischeibenkupplung / for vehicles with double disc clutch Sonderausführung / Special design	(68) (77)	
	10.90 - 09.96			1888 063 137	380 GF2/380N	625.130-131-132 658.024/043 für Nebenantrieb / for PTO enthält eine Kupplungsscheibe / This part number includes one clutch disc	(82) (66)	
	01.94 - 09.96	OM402LA, 442LA		1862 304 033 ▽	380 10 380GV	625.130-131-132 658.024/043 für Nebenantrieb / for PTO Lose Kupplungsscheibe / Loose clutch disc	(82) (39)	
	10.90 - 09.96			3151 166 031	KZI-6	625.130-131-132 658.024/043 für Nebenantrieb / for PTO	(82)	
					1882 019 133	380 GF2/380N	625.130-131-132 658.024/043 In 1888 enthalten / Contained in 1888	(29)
					1859 250 101	380 GF2/380	625.130-131-132 658.024/043 In 1888 enthalten / Contained in 1888	(29)
					1862 305 033 △	380 10 380GVZ	658.024/043 625.130-131-132 In 1888 enthalten / Contained in 1888	(29)









3244							
3244 625.130-132	01.94 - 09.96	OM402LA, 423, 442LA		3400 122 601  3482 081 231  1878 080 037  3151 000 278	430 10 MFZ430 430WGTZ KZISZ-5	625.130-132	
				3400 122 901  3482 081 233  1878 002 735  3151 000 278	430 10 MFZ430 430GTZ KZISZ-5	für / for: SA033617-01 625.130-132	(68)
3244 625.130-132 658.043 658.029		OM402LA, 423, 442LA		3400 122 601  3482 081 231  1878 080 037  3151 000 278	430 10 MFZ430 430WGTZ KZISZ-5	658.029/043 625.130-132	
				3400 122 901  3482 081 233  1878 002 735  3151 000 278	430 10 MFZ430 430GTZ KZISZ-5	für / for: SA033617-01 658.029/043 625.130-132	(68)
		OM402LA, 442LA		1888 063 137	380 GF2/380N	658.043 für Nebenantrieb / for PTO enthält eine Kupplungsscheibe / This part number includes one clutch disc	(82) (66)
				1862 304 033 ▽	380 10 380GV	658.043 für Nebenantrieb / for PTO Lose Kupplungsscheibe / Loose clutch disc	(82) (39)
				3151 166 031	KZI-6	658.043 für Nebenantrieb / for PTO	(82)
				1882 019 133	380 GF2/380N	658.043 In 1888 enthalten / Contained in 1888	(29)
				1859 250 101	380 GF2/380	658.043 In 1888 enthalten / Contained in 1888	(29)
				1862 305 033 △	380 10 380GVZ	658.043 In 1888 enthalten / Contained in 1888	(29)



3248						
3248 658.071 658.073 3248 658.195	07.87 - 09.96	OM442LA		3400 121 601  3488 017 432  1878 634 022  3151 000 547	400 10 MFZ2/400X 400GVZ KZISZ-5	->Chass. K011863 658.071/073/195
	07.87 - 09.96			3400 122 901  3482 081 233  1878 002 735  3151 000 278	430 10 MFZ430 430GTZ KZISZ-5	Chass. K011864-> 658.071/073/195

		CODE				
--	--	------	--	---	---	---

MERCEDES-BENZ

























3250						
3250 625.131/132 625.130		OM442LA	 3400 122 601 ⊗ 3482 081 231 ⊗ 1878 080 037 ⊙ 3151 000 278	430 10 MFZ430 430WGTZ KZISZ-5	625.130-131-132	
			 3400 122 901 ⊗ 3482 081 233 ⊗ 1878 002 735 ⊙ 3151 000 278	430 10 MFZ430 430GTZ KZISZ-5	für / for: SA033617-01 625.130-131-132	(68)
3250 A 625.382	09.85 - 08.94	OM423.950, OM423.951	 3483 023 001 ⊕	445 GMFZ445W	625.382 für Fahrzeuge mit Wandlerschaltkupplung / for vehicles with converter and clutch unit	(76)
3250 L 658.473	07.87 - 09.96	OM442LA	 3400 121 601 ⊗ 3488 017 432 ⊗ 1878 634 022 ⊙ 3151 000 547	400 10 MFZ2/400X 400GVZ KZISZ-5	->Chass. K011863 658.473	
			 3400 122 901 ⊗ 3482 081 233 ⊗ 1878 002 735 ⊙ 3151 000 278	430 10 MFZ430 430GTZ KZISZ-5	Chass. K011864-> 658.473	

3253						
3253, 3253 L 658.474 625.130 625.132 658.071 625.131	01.96 - 09.96	OM446.933, OM446.920, OM446.945	 3400 122 601 ⊗ 3482 081 231 ⊗ 1878 080 037 ⊙ 3151 000 278	430 10 MFZ430 430WGTZ KZISZ-5		
			 3400 122 901 ⊗ 3482 081 233 ⊗ 1878 002 735 ⊙ 3151 000 278	430 10 MFZ430 430GTZ KZISZ-5	für / for: SA033617-01	(68)
			 3400 121 601 HD ⊗ 3488 017 432 ⊗ 1878 634 022 ⊙ 3151 000 547	400 10 MFZ2/400X 400GVZ KZISZ-5	für Fahrzeuge mit Zweischeibenkupplung / for vehicles with double disc clutch Sonderausführung / Special design	(77) (56)
			 1888 063 137	380 GF2/380N	für Nebenantrieb / for PTO enthält eine Kupplungsscheibe / This part number includes one clutch disc	(82) (66)
			 1862 304 033 ▽	380 10 380GV	für Nebenantrieb / for PTO Lose Kupplungsscheibe / Loose clutch disc	(82) (39)
			 3151 166 031	KZI-6	für Nebenantrieb / for PTO	(82)
			 1882 019 133	380 GF2/380N	In 1888 enthalten / Contained in 1888	(29)
			 1859 250 101	380 GF2/380	In 1888 enthalten / Contained in 1888	(29)
			 1862 305 033 △	380 10 380GVZ	In 1888 enthalten / Contained in 1888	(29)

3255						
3255 658.195	07.87 - 09.96	OM442LA	 3400 121 601 ⊗ 3488 017 432 ⊗ 1878 634 022 ⊙ 3151 000 547	400 10 MFZ2/400X 400GVZ KZISZ-5	->Chass. K011863 658.195	
			 3400 122 901 ⊗ 3482 081 233 ⊗ 1878 002 735 ⊙ 3151 000 278	430 10 MFZ430 430GTZ KZISZ-5	Chass. K011864-> 658.195	

		CODE				
--	--	------	--	---	---	---





























MERCEDES-BENZ

3328								
3328 624.033	02.80 - 03.91	OM422	 1800 125 301  1882 301 239  1878 002 706  3151 000 375	420 10 GF420 420GTZ KZIS-4	624.033/233			
			 3482 124 534 ●	430 GMF430	624.033/233			
			 1882 304 237	420 GF420N	624.033 für Nebenantrieb / for PTO	(82)		
			 1878 003 269	420 10 420GTZ	624.033 für Nebenantrieb / for PTO	(82)		
			 3151 204 001	KZI-6	624.033 für Nebenantrieb / for PTO mit Schmierrohranschluß / with lubricating pipe coupling	(82) (91)		
			 1878 000 964	380 10 380GTZ	Getr. / GBox: ZF 16S-160 624.233 für Nebenantrieb / for PTO Nebenantriebs-ID / PTO ID: NMV	(82) (48)		
			 3151 204 001	KZI-6	Getr. / GBox: ZF 16S-160 624.233 für Nebenantrieb / for PTO mit Schmierrohranschluß / with lubricating pipe coupling Nebenantriebs-ID / PTO ID: NMV	(82) (91) (48)		
3328 B 625.025 625.028	07.82 - 07.87	OM422	 1800 125 301  1882 301 239  1878 002 706  3151 000 375	420 10 GF420 420GTZ KZIS-4	624.032/232 625.025/028-029			
			 3482 124 534 ●	430 GMF430	624.032/232 625.025/028-029			
			 1888 055 041	380 GF2/380	625.028-029 enthält eine Kupplungsscheibe / This part number includes one clutch disc	(66)		
			 1862 135 035 ▽	380 10 380GS	625.028-029 Lose Kupplungsscheibe / Loose clutch disc	(39)		
			 3151 108 031	KZI-4,5	625.028-029			
			 1882 349 003	380 GF2/380	625.028-029 In 1888 enthalten / Contained in 1888	(29)		
			 1859 250 100	380 GF2/380	625.028-029 In 1888 enthalten / Contained in 1888	(29)		
			 1862 138 032 △	380 10 380GSZ	625.028-029 In 1888 enthalten / Contained in 1888	(29)		
			 1882 304 237	420 GF420N	625.025/028-029 für Nebenantrieb / for PTO	(82)		
			 1878 003 269	420 10 420GTZ	625.025/028-029 für Nebenantrieb / for PTO	(82)		
		 3151 204 001	KZI-6	625.025/028-029 für Nebenantrieb / for PTO mit Schmierrohranschluß / with lubricating pipe coupling	(82) (91)			
				OM422.919, OM422.914				











		CODE		 Parameter		
--	--	------	--	---	---	---

MERCEDES-BENZ

3328









3328 B 624.032 624.232	02.80 - 03.91	OM422	 1800 125 301  1882 301 239  1878 002 706  3151 000 375	420 10 GF420 420GTZ KZIS-4	624.032/232 625.025/028-029	
			 3482 124 534 ●	430 GMF430	624.032/232 625.025/028-029	
			 1888 055 041	380 GF2/380	625.028-029 enthält eine Kupplungsscheibe / This part number includes one clutch disc	(66)
			 1862 135 035 ▽	380 10 380GS	625.028-029 Lose Kupplungsscheibe / Loose clutch disc	(39)
			 3151 108 031	KZI-4,5	625.028-029	
			 1882 349 003	380 GF2/380	625.028-029 In 1888 enthalten / Contained in 1888	(29)
			 1859 250 100	380 GF2/380	625.028-029 In 1888 enthalten / Contained in 1888	(29)
			 1862 138 032 △	380 10 380GSZ	625.028-029 In 1888 enthalten / Contained in 1888	(29)
		OM422.905, OM422.907, OM422.911, OM422.913, OM422.916	 1882 304 237	420 GF420N	625.028-029 für Nebenantrieb / for PTO	(82)
			 1862 268 031	420 10 420GVZ	625.028-029 für Nebenantrieb / for PTO	(82)
			 1882 304 237	420 GF420N	624.032/232 für Nebenantrieb / for PTO	(82)
			 1878 003 269	420 10 420GTZ	624.032/232 für Nebenantrieb / for PTO	(82)
			 3151 204 001	KZI-6	624.032/232 für Nebenantrieb / for PTO mit Schmierrohranschluß / with lubricating pipe coupling	(82) (91)
3328 K 625.029	07.82 - 07.87	OM422	 1800 125 301  1882 301 239  1878 002 706  3151 000 375	420 10 GF420 420GTZ KZIS-4	624.032/232 625.025/028-029	
			 3482 124 534 ●	430 GMF430	624.032/232 625.025/028-029	
			 1888 055 041	380 GF2/380	625.028-029 enthält eine Kupplungsscheibe / This part number includes one clutch disc	(66)
			 1862 135 035 ▽	380 10 380GS	625.028-029 Lose Kupplungsscheibe / Loose clutch disc	(39)
			 3151 108 031	KZI-4,5	625.028-029	
			 1882 349 003	380 GF2/380	625.028-029 In 1888 enthalten / Contained in 1888	(29)
			 1859 250 100	380 GF2/380	625.028-029 In 1888 enthalten / Contained in 1888	(29)
			 1882 304 237	420 GF420N	625.025/028-029 für Nebenantrieb / for PTO	(82)
		OM422.919, OM422.914	 1878 003 269	420 10 420GTZ	625.025/028-029 für Nebenantrieb / for PTO	(82)
			 3151 204 001	KZI-6	625.025/028-029 für Nebenantrieb / for PTO mit Schmierrohranschluß / with lubricating pipe coupling	(82) (91)



















3332

3332 395.325/326		OM403	 1800 125 301  1882 301 239  1878 002 706  3151 000 375	420 10 GF420 420GTZ KZIS-4	395.325-326	
			 3482 124 534 ●	430 GMF430	395.325-326	
			 1800 125 301  1882 301 239  1878 002 706  3151 000 375	420 10 GF420 420GTZ KZIS-4	395.325-326 Sonderausführung / Special design	(56)
			 3482 124 534 ●	430 GMF430	395.325-326 Sonderausführung / Special design	(56)































		CODE				
--	--	------	--	---	---	---

MERCEDES-BENZ

3333							
3333 624.048 623.048 3333 624.048 3333 K 624.048 3333 B 624.048	12.82 - 11.91	OM422A, 423		1882 342 134	420 GF420X	624.048 623.048	
				1878 002 878	420 10 420GTZ	624.048 623.048	
	12.82 - 11.91	OM422LA, 423		3151 110 031	KZI-4,5	623.048 624.048	
				1888 042 009	380 GF2/380	624.048 enthält eine Kupplungsscheibe / This part number includes one clutch disc Sonderausführung / Special design	(66)
	12.82 - 11.91	OM422LA, 423		1878 000 968 ▽	380 10 380GTZ	624.048 Sonderausführung / Special design Lose Kupplungsscheibe / Loose clutch disc	(56) (39)
				3151 108 031	KZI-4,5	624.048 Sonderausführung / Special design	(56)
				1882 341 001	380 GF2/380	624.048 In 1888 enthalten / Contained in 1888 Sonderausführung / Special design	(29) (56)
				1859 250 102	380 GF2/380	624.048 In 1888 enthalten / Contained in 1888 Sonderausführung / Special design	(29) (56)
			1878 000 968 △	380 10 380GTZ	624.048 In 1888 enthalten / Contained in 1888 Sonderausführung / Special design	(29) (56)	

























3335							
3335 648.013 649.038	04.86 - 03.91	OM422A		1888 055 041	380 GF2/380	649.038 enthält eine Kupplungsscheibe / This part number includes one clutch disc	(66)
				1862 135 035 ▽	380 10 380GS	649.038 Lose Kupplungsscheibe / Loose clutch disc	(39)
				3151 108 031	KZI-4,5	649.038	
				1882 349 003	380 GF2/380	649.038 In 1888 enthalten / Contained in 1888	(29)
				1859 250 100	380 GF2/380	649.038 In 1888 enthalten / Contained in 1888	(29)
				1862 138 032 △	380 10 380GSZ	649.038 In 1888 enthalten / Contained in 1888	(29)
				1888 063 137	380 GF2/380N	649.038 für Nebenantrieb / for PTO enthält eine Kupplungsscheibe / This part number includes one clutch disc	(82) (66)
				1862 304 033	380 10 380GV	649.038 für Nebenantrieb / for PTO	(82)
3335 648.038 624.233		OM423		1800 125 301 ● 1882 301 239 ● 1878 002 706 ● 3151 000 375	420 10 GF420 420GTZ KZIS-4	624.233	
				3482 124 534 ●	430 GMF430	624.233	
3335 A 649.237	04.86 - 03.91	OM422A		1888 055 041	380 GF2/380	649.237 enthält eine Kupplungsscheibe / This part number includes one clutch disc	(66)
				1862 135 035 ▽	380 10 380GS	649.237 Lose Kupplungsscheibe / Loose clutch disc	(39)
				3151 108 031	KZI-4,5	649.237	
				1882 349 003	380 GF2/380	649.237 In 1888 enthalten / Contained in 1888	(29)
				1859 250 100	380 GF2/380	649.237 In 1888 enthalten / Contained in 1888	(29)
				1862 138 032 △	380 10 380GSZ	649.237 In 1888 enthalten / Contained in 1888	(29)
				1882 304 237	420 GF420N	649.237 für Nebenantrieb / for PTO	(82)
				1878 003 269	420 10 420GTZ	649.237 für Nebenantrieb / for PTO	(82)
	3151 204 001	KZI-6	649.237 für Nebenantrieb / for PTO	(82)			







MERCEDES-BENZ

3336						
3336 624.233		OM442A	 1800 125 301  1882 301 239  1878 002 706  3151 000 375	420 10 GF420 420GTZ KZIS-4	624.233	
			 3482 124 534 ●	430 GMF430	624.233	
			 1878 000 964	380 10 380GTZ	Getr. / GBox: ZF 16S-160 624.233 für Nebenantrieb / for PTO Nebenantriebs-ID / PTO ID: NMV	(82) (48)
			 3151 204 001	KZI-6	Getr. / GBox: ZF 16S-160 624.233 für Nebenantrieb / for PTO mit Schmierrohranschluß / with lubricating pipe coupling Nebenantriebs-ID / PTO ID: NMV	(82) (91) (48)
3336 624.037 624.203 624.038 3336 A 624.237 3336 A 624.237 3336 AK 624.237	12.82 - 11.91	OM422A, 423	 1882 342 134	420 GF420X	624.037-038/136-137/139/237	
	11.81 - 03.91		 1878 002 878	420 10 420GTZ	624.037-038/136-137/139/237	
	11.81 - 03.91		 3151 110 031	KZI-4,5	624.037-038/136-137/139/237	
	09.86 - 11.91	OM422LA, 423	 1888 042 009	380 GF2/380	624.037-038/136-137/139/237 enthält eine Kupplungsscheibe / This part number includes one clutch disc	(66)
			 1878 000 968 ▽	380 10 380GTZ	624.037-038/136-137/139/237 Lose Kupplungsscheibe / Loose clutch disc	(39)
			 3151 108 031	KZI-4,5	624.037-038/136-137/139/237	
			 1882 341 001	380 GF2/380	624.037-038/136-137/139/237 In 1888 enthalten / Contained in 1888	(29)
			 1859 250 102	380 GF2/380	624.037-038/136-137/139/237 In 1888 enthalten / Contained in 1888	(29)
			 1878 000 968 △	380 10 380GTZ	624.037-038/136-137/139/237 In 1888 enthalten / Contained in 1888	(29)
			 1882 346 131 #	420 GF420XN	624.037/139/237	
	12.82 - 11.91	OM422A, 423	 1878 002 706	420 10 420GTZ	624.037/139/237	
			 3151 204 001	KZI-6	624.037/139/237 mit Schmierrohranschluß / with lubricating pipe coupling	(91)
			 1882 342 134	420 GF420X		
 1878 002 878			420 10 420GTZ			
 3151 110 031			KZI-4,5			
 1888 042 009			380 GF2/380	enthält eine Kupplungsscheibe / This part number includes one clutch disc	(66)	
 1878 000 968 ▽			380 10 380GTZ	Lose Kupplungsscheibe / Loose clutch disc	(39)	
 3151 108 031			KZI-4,5			
 1882 341 001			380 GF2/380	In 1888 enthalten / Contained in 1888	(29)	
 1859 250 102			380 GF2/380	In 1888 enthalten / Contained in 1888	(29)	
12.82 - 11.91	OM422LA, 423	 1878 000 968 △	380 10 380GTZ	In 1888 enthalten / Contained in 1888	(29)	
		 1882 346 131 #	420 GF420XN	624.037/139/237		
		 1878 002 706	420 10 420GTZ	624.037/139/237		
		 3151 204 001	KZI-6	624.037/139/237 mit Schmierrohranschluß / with lubricating pipe coupling	(91)	

		CODE				
--	--	------	--	---	---	---







MERCEDES-BENZ























3336							
3336 K 624.139 624.137	12.82 - 11.91	OM422A, 423		1882 342 134	420 GF420X	624.037-038/136-137/139/237	
				1878 002 878	420 10 420GTZ	624.037-038/136-137/139/237	
				3151 110 031	KZI-4,5	624.037-038/136-137/139/237	
		OM422LA, 423		1888 042 009	380 GF2/380	624.037-038/136-137/139/237 enthält eine Kupplungsscheibe / This part number includes one clutch disc	(66)
				1878 000 968 ▽	380 10 380GTZ	624.037-038/136-137/139/237 Lose Kupplungsscheibe / Loose clutch disc	(39)
				3151 108 031	KZI-4,5	624.037-038/136-137/139/237	
				1882 341 001	380 GF2/380	624.037-038/136-137/139/237 In 1888 enthalten / Contained in 1888	(29)
				1859 250 102	380 GF2/380	624.037-038/136-137/139/237 In 1888 enthalten / Contained in 1888	(29)
				1878 000 968 △	380 10 380GTZ	624.037-038/136-137/139/237 In 1888 enthalten / Contained in 1888	(29)
				1882 346 131 #	420 GF420XN	624.137 für Nebenantrieb / for PTO	(82)
				1878 002 706	420 10 420GTZ	624.137 für Nebenantrieb / for PTO	(82)
				3151 204 001	KZI-6	624.137 für Nebenantrieb / for PTO mit Schmierrohranschluß / with lubricating pipe coupling	(82) (91)
3336 S 624.136	12.82 - 11.91	OM422A, 423		1882 342 134	420 GF420X	624.037-038/136-137/139/237	
				1878 002 878	420 10 420GTZ	624.037-038/136-137/139/237	
				3151 110 031	KZI-4,5	624.037-038/136-137/139/237	
		OM422LA, 423		1888 042 009	380 GF2/380	624.037-038/136-137/139/237 enthält eine Kupplungsscheibe / This part number includes one clutch disc	(66)
				1878 000 968 ▽	380 10 380GTZ	624.037-038/136-137/139/237 Lose Kupplungsscheibe / Loose clutch disc	(39)
				3151 108 031	KZI-4,5	624.037-038/136-137/139/237	
				1882 341 001	380 GF2/380	624.037-038/136-137/139/237 In 1888 enthalten / Contained in 1888	(29)
				1859 250 102	380 GF2/380	624.037-038/136-137/139/237 In 1888 enthalten / Contained in 1888	(29)
				1878 000 968 △	380 10 380GTZ	624.037-038/136-137/139/237 In 1888 enthalten / Contained in 1888	(29)
				1882 346 131 #	420 GF420XN	624.136 für Nebenantrieb / for PTO	(82)
				1878 002 706	420 10 420GTZ	624.136 für Nebenantrieb / for PTO	(82)
				3151 204 001	KZI-6	624.136 für Nebenantrieb / for PTO mit Schmierrohranschluß / with lubricating pipe coupling	(82) (91)

3338							
3338 624.191	01.81 - 12.86	OM422LA		1888 042 009	380 GF2/380	624.191 enthält eine Kupplungsscheibe / This part number includes one clutch disc	(66)
				1878 000 968 ▽	380 10 380GTZ	624.191 Lose Kupplungsscheibe / Loose clutch disc	(39)
				3151 108 031	KZI-4,5	624.191	
				1882 341 001	380 GF2/380	624.191 In 1888 enthalten / Contained in 1888	(29)
				1859 250 102	380 GF2/380	624.191 In 1888 enthalten / Contained in 1888	(29)
				1878 000 968 △	380 10 380GTZ	624.191 In 1888 enthalten / Contained in 1888	(29)

		CODE					
--	--	------	--	--	---	---	---



































MERCEDES-BENZ

3344							
3344 ,S 649.196		OM442		1888 055 247	380 GF2/380	649.196 enthält eine Kupplungsscheibe / This part number includes one clutch disc	(66)
				1862 123 131 ▽	380 10 380GV	649.196 Lose Kupplungsscheibe / Loose clutch disc	(39)
				3151 108 031	KZI-4,5	649.196	
				1882 349 003	380 GF2/380	649.196 In 1888 enthalten / Contained in 1888	(29)
				1859 250 100	380 GF2/380	649.196 In 1888 enthalten / Contained in 1888	(29)
				1862 122 132 △	380 10 380GVZ	649.196 In 1888 enthalten / Contained in 1888	(29)

3528									
3528 625.028	07.82 - 07.87	OM422		1800 125 301 ● 1882 301 239 ● 1878 002 706 ● 3151 000 375	420 10 GF420 420GTZ KZIS-4	624.033/232-233 625.025/028-029			
				3482 124 534 ●	430 GMF430	624.033/232-233 625.025/028-029			
				1888 055 041	380 GF2/380	625.028-029 enthält eine Kupplungsscheibe / This part number includes one clutch disc	(66)		
				1862 135 035	380 10 380GS	625.028-029 Lose Kupplungsscheibe / Loose clutch disc	(39)		
				3151 108 031	KZI-4,5	625.028-029			
				1882 349 003	380 GF2/380	625.028-029 In 1888 enthalten / Contained in 1888	(29)		
				1859 250 100	380 GF2/380	625.028-029 In 1888 enthalten / Contained in 1888	(29)		
				1862 138 032	380 10 380GSZ	625.028-029 In 1888 enthalten / Contained in 1888	(29)		
				1882 304 237	420 GF420N	624.033 625.028-029 für Nebenantrieb / for PTO	(82)		
				1878 003 269	420 10 420GTZ	624.033 625.028-029 für Nebenantrieb / for PTO	(82)		
			3151 204 001	KZI-6	624.033 625.028-029 für Nebenantrieb / for PTO mit Schmierrohranschluß / with lubricating pipe coupling	(82) (91)			
		3528 B 625.025	07.87 - 09.89	OM422		1800 125 301 ● 1882 301 239 ● 1878 002 706 ● 3151 000 375	420 10 GF420 420GTZ KZIS-4	624.033/232-233 625.025/028-029	
						3482 124 534 ●	430 GMF430	624.033/232-233 625.025/028-029	
						1888 055 041	380 GF2/380	625.028-029 enthält eine Kupplungsscheibe / This part number includes one clutch disc	(66)
	1862 135 035				380 10 380GS	625.028-029 Lose Kupplungsscheibe / Loose clutch disc	(39)		
	3151 108 031				KZI-4,5	625.028-029			
	1882 349 003				380 GF2/380	625.028-029 In 1888 enthalten / Contained in 1888	(29)		
	1859 250 100				380 GF2/380	625.028-029 In 1888 enthalten / Contained in 1888	(29)		
	1862 138 032				380 10 380GSZ	625.028-029 In 1888 enthalten / Contained in 1888	(29)		
	1882 304 237	420 GF420N	625.025/028-029 für Nebenantrieb / for PTO		(82)				
	1878 003 269	420 10 420GTZ	625.025/028-029 für Nebenantrieb / for PTO		(82)				
	3151 204 001	KZI-6	625.025/029 für Nebenantrieb / for PTO mit Schmierrohranschluß / with lubricating pipe coupling	(82) (91)					
		OM422.919							











		CODE				
--	--	------	--	---	---	---















MERCEDES-BENZ

3528									
3528 K 624.232	07.87 - 09.89	OM422	 1800 125 301  1882 301 239  1878 002 706  3151 000 375	420 10 GF420 420GTZ KZIS-4	624.033/232-233 625.025/028-029				
			 3482 124 534 ●	430 GMF430	624.033/232-233 625.025/028-029				
			 1888 055 041	380 GF2/380	625.028-029 enthält eine Kupplungsscheibe / This part number includes one clutch disc	(66)			
			 1862 135 035	380 10 380GS	625.028-029 Lose Kupplungsscheibe / Loose clutch disc	(39)			
			 3151 108 031	KZI-4,5	625.028-029				
			 1882 349 003	380 GF2/380	625.028-029 In 1888 enthalten / Contained in 1888	(29)			
			 1859 250 100	380 GF2/380	625.028-029 In 1888 enthalten / Contained in 1888	(29)			
			 1862 138 032	380 10 380GSZ	625.028-029 In 1888 enthalten / Contained in 1888	(29)			
				OM422.919	 1882 304 237	420 GF420N	625.028-029 Nebenantriebs-ID / PTO ID: 110	(48)	
					 1862 268 031	420 10 420GVZ	625.028-029 Nebenantriebs-ID / PTO ID: 110	(48)	
					 1882 304 237	420 GF420N	624.232 für Nebenantrieb / for PTO	(82)	
					 1878 003 269	420 10 420GTZ	624.232 für Nebenantrieb / for PTO	(82)	
					 3151 204 001	KZI-6	624.232 für Nebenantrieb / for PTO mit Schmierrohranschluß / with lubricating pipe coupling	(82) (91)	
			3528 K 625.029	07.82 - 07.87	OM422	 1800 125 301  1882 301 239  1878 002 706  3151 000 375	420 10 GF420 420GTZ KZIS-4	624.033/232-233 625.025/028-029	
 3482 124 534 ●	430 GMF430	624.033/232-233 625.025/028-029							
 1888 055 041	380 GF2/380	625.028-029 enthält eine Kupplungsscheibe / This part number includes one clutch disc				(66)			
 1862 135 035	380 10 380GS	625.028-029 Lose Kupplungsscheibe / Loose clutch disc				(39)			
 3151 108 031	KZI-4,5	625.028-029							
 1882 349 003	380 GF2/380	625.028-029 In 1888 enthalten / Contained in 1888				(29)			
 1859 250 100	380 GF2/380	625.028-029 In 1888 enthalten / Contained in 1888				(29)			
 1862 138 032	380 10 380GSZ	625.028-029 In 1888 enthalten / Contained in 1888				(29)			
	OM422.919	 1882 304 237				420 GF420N	625.025/028-029 für Nebenantrieb / for PTO	(82)	
		 1878 003 269				420 10 420GTZ	625.025/028-029 für Nebenantrieb / for PTO	(82)	
		 3151 204 001				KZI-6	625.025/028-029 für Nebenantrieb / for PTO mit Schmierrohranschluß / with lubricating pipe coupling	(82) (91)	
3529									
3529 659.032	07.88 - 08.94	OM442				 3400 124 101  3482 081 232  1878 005 668  3151 000 549	430 10 MFZ430 430WGTZ KZISZ-5	659.032	

		CODE				
--	--	------	--	---	---	---



























MERCEDES-BENZ

3534						
3534 K 625.142 625.140	10.93 - 09.96	OM441.988, OM445.922	 3400 124 001  3482 081 231  1878 634 027  3151 000 278	430 10 MFZ430 430WGTZ KZISZ-5	625.140/142	
			 1888 063 137	380 GF2/380N	625.140/142 für Nebenantrieb / for PTO enthält eine Kupplungsscheibe / This part number includes one clutch disc	(82) (66)
			 1862 304 033 ▽	380 10 380GV	625.140/142 für Nebenantrieb / for PTO Lose Kupplungsscheibe / Loose clutch disc	(82) (39)
			 3151 166 031	KZI-6	625.140/142 für Nebenantrieb / for PTO	(82)
			 1882 019 133	380 GF2/380N	625.140/142 In 1888 enthalten / Contained in 1888	(29)
			 1859 250 101	380 GF2/380	625.140/142 In 1888 enthalten / Contained in 1888	(29)
			 1862 305 033 △	380 10 380GVZ	625.140/142 In 1888 enthalten / Contained in 1888	(29)

3535						
3535 659.233 625.019 624.232 3535,K 625.019			 1882 304 237	420 GF420N	625.019 für Nebenantrieb / for PTO	(82)
			 1878 003 269	420 10 420GTZ	625.019 für Nebenantrieb / for PTO	(82)
			 3151 204 001	KZI-6	625.019 für Nebenantrieb / for PTO mit Schmierrohranschluß / with lubricating pipe coupling	(82) (91)
3535 659.038 659.233	07.88 - 08.94	OM442.964, OM442.966, OM442.959, OM442.944, OM442.942	 3400 122 601  3482 081 231  1878 080 037  3151 000 278	430 10 MFZ430 430WGTZ KZISZ-5	659.038	
			 3400 124 101	430 10 MFZ430 430WGTZ KZISZ-5	659.233	
			 3400 122 601  3482 081 231  1878 080 037  3151 000 278	430 10 MFZ430 430WGTZ KZISZ-5	659.233 Sonderausführung / Special design	(56)
3535 A 649.237			 1882 304 237	420 GF420N	für Nebenantrieb / for PTO	(82)
			 1878 003 269	420 10 420GTZ	für Nebenantrieb / for PTO	(82)
			 3151 204 001	KZI-6	für Nebenantrieb / for PTO mit Schmierrohranschluß / with lubricating pipe coupling	(82) (91)







































		CODE				
--	--	------	--	---	---	---

MERCEDES-BENZ

3535						
3535 AK 624.233 624.232	09.87 - 02.90	OM423, 442	 1800 125 301  1882 301 239  1878 002 706  3151 000 375	420 10 GF420 420GTZ KZIS-4	624.232-233 625.029/025/028	
			 3482 124 534 ●	430 GMF430	624.232-233 625.029/025/028	
		OM442	 1888 055 041	380 GF2/380	624.232-233 625.029 enthält eine Kupplungsscheibe / This part number includes one clutch disc	(66)
			 1862 135 035 ▽	380 10 380GS	624.232-233 625.029 Lose Kupplungsscheibe / Loose clutch disc	(39)
			 3151 108 031	KZI-4,5	625.029 624.232-233	
			 1882 349 003	380 GF2/380	624.232-233 625.029 In 1888 enthalten / Contained in 1888	(29)
			 1859 250 100	380 GF2/380	624.232-233 625.029 In 1888 enthalten / Contained in 1888	(29)
			 1862 138 032 △	380 10 380GSZ	624.232-233 625.029 In 1888 enthalten / Contained in 1888	(29)
			 1882 304 237	420 GF420N	624.232 für Nebenantrieb / for PTO	(82)
			 1878 003 269	420 10 420GTZ	624.232 für Nebenantrieb / for PTO	(82)
			 3151 204 001	KZI-6	624.232 für Nebenantrieb / for PTO mit Schmierrohranschluß / with lubricating pipe coupling	(82) (91)
			 1878 000 964	380 10 380GTZ	Getr. / GBox: ZF16S-160 624.233 für Nebenantrieb / for PTO Nebenantriebs-ID / PTO ID: NMV	(82) (48)
			 3151 204 001	KZI-6	Getr. / GBox: ZF16S-160 624.233 für Nebenantrieb / for PTO mit Schmierrohranschluß / with lubricating pipe coupling Nebenantriebs-ID / PTO ID: NMV	(82) (91) (48)
	3535 AK 625.249 3535 B 625.145 3535 B 625.145 3535 K 625.148/149 3535 K 625.148/149 3535 S 659.136	02.90 - 08.94	OM442A	 3400 122 601  3482 081 231  1878 080 037  3151 000 278	430 10 MFZ430 430WGTZ KZISZ-5	625.145/148-149/249 659.038/136/237
10.88 - 08.94			 1888 063 137	380 GF2/380N	625.148-149/249 656.215 für Nebenantrieb / for PTO enthält eine Kupplungsscheibe / This part number includes one clutch disc	(82) (66)
10.88 - 08.94			 1862 304 033 ▽	380 10 380GV	625.148-149/249 656.215 für Nebenantrieb / for PTO Lose Kupplungsscheibe / Loose clutch disc	(82) (39)
10.88 - 08.94			 3151 166 031	KZI-6	625.148-149/249 656.215 für Nebenantrieb / for PTO	(82)
10.88 - 08.94			 1882 019 133	380 GF2/380N	625.148-149/249 656.215 In 1888 enthalten / Contained in 1888	(29)
07.88 - 08.94			 1859 250 101	380 GF2/380	625.148-149/249 656.215 In 1888 enthalten / Contained in 1888	(29)
			 1862 305 033 △	380 10 380GVZ	625.148-149/249 656.215 In 1888 enthalten / Contained in 1888	(29)





















		CODE					
--	--	------	--	--	---	---	---

MERCEDES-BENZ

















3535									
3535 AK 625.249 3535 K 625.149	03.91 - 08.94	OM402.982, OM402.983	 3400 122 601  3482 081 231  1878 080 037  3151 000 278	430 10 MFZ430 430WGTZ KZISZ-5					
	03.91 - 08.94		 3400 121 601 HD  3488 017 432  1878 634 022  3151 000 547	400 10 MFZ2/400X 400GVZ KZISZ-5	für Fahrzeuge mit Zweischeibenkupplung / for vehicles with double disc clutch	(77)			
			 1888 063 137	380 GF2/380N	für Nebenantrieb / for PTO enthält eine Kupplungsscheibe / This part number includes one clutch disc	(82) (66)			
			 1862 304 033 ▽	380 10 380GV	für Nebenantrieb / for PTO Lose Kupplungsscheibe / Loose clutch disc	(82) (39)			
			 3151 166 031	KZI-6	für Nebenantrieb / for PTO	(82)			
			 1882 019 133	380 GF2/380N	In 1888 enthalten / Contained in 1888	(29)			
			 1859 250 101	380 GF2/380	In 1888 enthalten / Contained in 1888	(29)			
			 1862 305 033 △	380 10 380GVZ	In 1888 enthalten / Contained in 1888	(29)			
3535 B 649.038 625.148 625.145 625.149			 1888 063 137	380 GF2/380N	649.038 für Nebenantrieb / for PTO enthält eine Kupplungsscheibe / This part number includes one clutch disc	(82) (66)			
			 1862 304 033	380 10 380GV	649.038 für Nebenantrieb / for PTO	(82)			
			 3151 204 001	KZI-6	649.038 für Nebenantrieb / for PTO mit Schmierrohranschluß / with lubricating pipe coupling	(82) (91)			
3535 K 625.019 625.025 625.028/029	09.87 - 01.89	OM423, 442	 1800 125 301  1882 301 239  1878 002 706  3151 000 375	420 10 GF420 420GTZ KZIS-4	624.232-233 625.029/025/028				
			 3482 124 534 ●	430 GMF430	624.232-233 625.029/025/028				
		OM442A	 1882 304 237	420 GF420N	01.1988-> 625.019/025 für Nebenantrieb / for PTO	(82)			
		 1878 003 269	420 10 420GTZ	01.1988-> 625.019/025 für Nebenantrieb / for PTO	(82)				
		 3151 204 001	KZI-6	01.1988-> 625.019/025 für Nebenantrieb / for PTO mit Schmierrohranschluß / with lubricating pipe coupling	(82) (91)				
		OM442	 1888 055 041	380 GF2/380	624.232-233 625.029 enthält eine Kupplungsscheibe / This part number includes one clutch disc	(66)			
		 1862 135 035 ▽	380 10 380GS	624.232-233 625.029 Lose Kupplungsscheibe / Loose clutch disc	(39)				
		 3151 108 031	KZI-4,5	625.029 624.232-233					
		 1882 349 003	380 GF2/380	624.232-233 625.029 In 1888 enthalten / Contained in 1888	(29)				
		 1859 250 100	380 GF2/380	624.232-233 625.029 In 1888 enthalten / Contained in 1888	(29)				
		 1862 138 032 △	380 10 380GSZ	624.232-233 625.029 In 1888 enthalten / Contained in 1888	(29)				
		3535 K 659.232 3535 L,K 656.215 659.032 659.233 659.232	07.87 - 09.96	OM442A, 443A	 3400 124 101  3482 081 232  1878 005 668  3151 000 549	430 10 MFZ430 430WGTZ KZISZ-5	659.032/232-233 656.215		
					 3400 122 601  3482 081 231  1878 080 037  3151 000 278	430 10 MFZ430 430WGTZ KZISZ-5	659.232-233 Sonderausführung / Special design	(56)	

		CODE				
--	--	------	--	---	---	---

MERCEDES-BENZ



































3536						
3536 K 624.139	12.82 - 11.91	OM422A, 423	 1882 342 134	420 GF420X		
			 1878 002 878	420 10 420GTZ		
			 3151 110 031	KZI-4,5		
		OM422LA, 423	 1888 042 009	380 GF2/380	enthält eine Kupplungsscheibe / This part number includes one clutch disc Sonderausführung / Special design	(66) (56)
			 1878 000 968 ▽	380 10 380GTZ	Lose Kupplungsscheibe / Loose clutch disc Sonderausführung / Special design	(39) (56)
			 3151 108 031	KZI-4,5	Sonderausführung / Special design	(56)
			 1882 341 001	380 GF2/380	In 1888 enthalten / Contained in 1888 Sonderausführung / Special design	(29) (56)
			 1859 250 102	380 GF2/380	In 1888 enthalten / Contained in 1888 Sonderausführung / Special design	(29) (56)
 1878 000 968 △	380 10 380GTZ	In 1888 enthalten / Contained in 1888 Sonderausführung / Special design	(29) (56)			
3536 S 624.137 624.136		OM422A, 423	 1882 342 134	420 GF420X	624.136-137	
			 1878 002 878	420 10 420GTZ	624.136-137	
			 3151 110 031	KZI-4,5	624.136-137	
		OM422LA, 423	 1888 042 009	380 GF2/380	624.136-137 enthält eine Kupplungsscheibe / This part number includes one clutch disc Sonderausführung / Special design	(66) (56)
			 1878 000 968 ▽	380 10 380GTZ	624.136-137 Lose Kupplungsscheibe / Loose clutch disc Sonderausführung / Special design	(39) (56)
			 3151 108 031	KZI-4,5	624.136-137 Sonderausführung / Special design	(56)
			 1882 341 001	380 GF2/380	624.136-137 In 1888 enthalten / Contained in 1888 Sonderausführung / Special design	(29) (56)
			 1859 250 102	380 GF2/380	624.136-137 In 1888 enthalten / Contained in 1888 Sonderausführung / Special design	(29) (56)
			 1878 000 968 △	380 10 380GTZ	624.136-137 In 1888 enthalten / Contained in 1888 Sonderausführung / Special design	(29) (56)
			 1882 346 131 #	420 GF420XN	624.136-137 für Nebenantrieb / for PTO	(82)
			 1878 002 706	420 10 420GTZ	624.136-137 für Nebenantrieb / for PTO	(82)
			 3151 204 001	KZI-6	624.136-137 für Nebenantrieb / for PTO mit Schmierrohranschluß / with lubricating pipe coupling	(82) (91)

MERCEDES-BENZ

3538							
3538 625.137 625.135 3538 AK 625.137 625.135 3538 AK 625.259 625.269 625.249 625.258 3538 AK 625.259 625.258 625.269 3538 AK 625.259 625.258 625.269 3538 AK 625.258/259 3538 K 625.137	03.91 - 09.96	OM440.970, OM440.987, OM440.975, OM440.983, OM440.984, OM402.982, OM446.926, OM446.930, OM446.931, OM402.983, OM440.979, OM442.997, OM402.978, OM440.982, OM402.973, OM442.989, OM446.939, OM440.985, OM446.940		3400 122 601 ● 3482 081 231 ● 1878 080 037 ● 3151 000 278	430 10 MFZ430 430WGTZ KZISZ-5		
	03.91 - 09.96			3400 122 901 ● 3482 081 233 ● 1878 002 735 ● 3151 000 278	430 10 MFZ430 430GTZ KZISZ-5	für / for: SA33613 für / for: SA33617	(68) (68)
	01.94 - 09.96			3400 121 601 HD ● 3488 017 432 ● 1878 634 022 ● 3151 000 547	400 10 MFZ2/400X 400GVZ KZISZ-5	für / for: SA32903-01/12 für / for: SA32903-05 für Fahrzeuge mit Zweischeibenkupplung / for vehicles with double disc clutch	(68) (68) (77)
	03.91 - 09.96			1888 063 137	380 GF2/380N	für Nebenantrieb / for PTO enthält eine Kupplungsscheibe / This part number includes one clutch disc	(82) (66)
	03.91 - 09.96			1862 304 033 ▽	380 10 380GV	für Nebenantrieb / for PTO Lose Kupplungsscheibe / Loose clutch disc	(82) (39)
				3151 166 031	KZI-6	für Nebenantrieb / for PTO	(82)
				1882 019 133	380 GF2/380N	In 1888 enthalten / Contained in 1888	(29)
				1859 250 101	380 GF2/380	In 1888 enthalten / Contained in 1888	(29)
				1862 305 033 △	380 10 380GVZ	In 1888 enthalten / Contained in 1888	(29)
	3538 659.233 625.137		OM402LA		3400 124 101 ● 3482 081 232 ● 1878 005 668 ● 3151 000 549	430 10 MFZ430 430WGTZ KZISZ-5	659.233
				3400 122 601 ● 3482 081 231 ● 1878 080 037 ● 3151 000 278	430 10 MFZ430 430WGTZ KZISZ-5	659.233 Sonderausführung / Special design	(56)
		OM442A		3400 121 601 ● 3488 017 432 ● 1878 634 022 ● 3151 000 547	400 10 MFZ2/400X 400GVZ KZISZ-5	625.137	
3538 AK 659.344				3400 122 601 ● 3482 081 231 ● 1878 080 037 ● 3151 000 278	430 10 MFZ430 430WGTZ KZISZ-5	659.344	
				3400 121 601 ● 3488 017 432 ● 1878 634 022 ● 3151 000 547	400 10 MFZ2/400X 400GVZ KZISZ-5	659.344 für Fahrzeuge mit Zweischeibenkupplung / for vehicles with double disc clutch	(77)
				3483 023 032 ⊕	445 GMFZ445W	659.344 für Fahrzeuge mit Wandlerschaltkupplung / for vehicles with converter and clutch unit	(76)
				1878 003 780	445 24 445GTZ	659.344 für Fahrzeuge mit Wandlerschaltkupplung / for vehicles with converter and clutch unit	(76)

















		CODE				
--	--	------	--	---	---	---





























MERCEDES-BENZ

3538							
3538 K 625.149 625.135-137 3538 K 625.136/137 3538 K 625.136/137	03.91 - 09.96	OM440.970, OM440.984, OM402.982, OM446.926,		3400 122 601  3482 081 231  1878 080 037  3151 000 278	430 10 MFZ430 430WGTZ KZISZ-5		
	01.94 - 09.96	OM446.930, OM402.983, OM440.979, OM402.978, OM402.973, OM402.987, OM446.939, OM446.940		3400 122 901  3482 081 233  1878 002 735  3151 000 278	430 10 MFZ430 430GTZ KZISZ-5	für / for: SA33613 für / for: SA33617	(68) (68)
	03.91 - 09.96			3400 121 601 HD  3488 017 432  1878 634 022  3151 000 547	400 10 MFZ2/400X 400GVZ KZISZ-5	für / for: SA32903-01/12 für / for: SA32903-05 für Fahrzeuge mit Zweischeibenkupplung / for vehicles with double disc clutch	(68) (68) (77)
				1888 063 137	380 GF2/380N	für Nebenantrieb / for PTO enthält eine Kupplungsscheibe / This part number includes one clutch disc	(82) (66)
				1862 304 033 ▽	380 10 380GV	für Nebenantrieb / for PTO Lose Kupplungsscheibe / Loose clutch disc	(82) (39)
				3151 166 031	KZI-6	für Nebenantrieb / for PTO	(82)
				1882 019 133	380 GF2/380N	In 1888 enthalten / Contained in 1888	(29)
				1859 250 101	380 GF2/380	In 1888 enthalten / Contained in 1888	(29)
				1862 305 033 △	380 10 380GVZ	In 1888 enthalten / Contained in 1888	(29)
				3483 023 032 ⊕	445 GMFZ445W	625.136 für Fahrzeuge mit Wandlerschaltkupplung / for vehicles with converter and clutch unit	(76)
				1878 003 780	445 24 445GTZ	625.136 für Fahrzeuge mit Wandlerschaltkupplung / for vehicles with converter and clutch unit	(76)
	3544						
	3544 648.073	08.73 - 09.96	OM442LA		1888 055 247	380 GF2/380	648.073/473 enthält eine Kupplungsscheibe / This part number includes one clutch disc
				1862 123 131 ▽	380 10 380GV	648.473 Lose Kupplungsscheibe / Loose clutch disc	(39)
				3151 108 031	KZI-4,5	648.073/473	
				1882 349 003	380 GF2/380	648.473 In 1888 enthalten / Contained in 1888	(29)
				1859 250 100	380 GF2/380	648.473 In 1888 enthalten / Contained in 1888	(29)
				1862 122 132 △	380 10 380GVZ	648.473 In 1888 enthalten / Contained in 1888	(29)
3544 659.191 659.093	01.92 - 09.96	OM440		3400 121 601  3488 017 432  1878 634 022  3151 000 547	400 10 MFZ2/400X 400GVZ KZISZ-5	->Chass. K011863 659.191	
				3400 122 901  3482 081 233  1878 002 735  3151 000 278	430 10 MFZ430 430GTZ KZISZ-5	Chass. K011863-> 659.191	

		CODE					
--	--	------	--	--	---	---	---























MERCEDES-BENZ

3544							
3544 AK 625.269 3544 K 625.136 3544 ,K,AK 625.269 625.136 625.258 625.137 625.259	03.91 - 09.96	OM402LA, 442LA		3400 122 601  3482 081 231  1878 080 037  3151 000 278	430 10 MFZ430 430WGTZ KZISZ-5	625.136-137/258-259/269	
	03.91 - 09.96			3400 122 901  3482 081 233  1878 002 735  3151 000 278	430 10 MFZ430 430GTZ KZISZ-5	für / for: SA033617-01 625.136-137/258-259/269	(68)
		OM442LA		1888 063 137	380 GF2/380N	625.269 Nebenantriebs-ID / PTO ID: 4/125 enthält eine Kupplungsscheibe / This part number includes one clutch disc	(48) (66)
				1862 304 033 ▽	380 10 380GV	625.269 Nebenantriebs-ID / PTO ID: 4/125 Lose Kupplungsscheibe / Loose clutch disc	(48) (39)
				3151 166 031	KZI-6	625.269 Nebenantriebs-ID / PTO ID: 4/125	(48)
				1882 019 133	380 GF2/380N	625.269 In 1888 enthalten / Contained in 1888	(29)
				1859 250 101	380 GF2/380	625.269 In 1888 enthalten / Contained in 1888	(29)
				1862 305 033 △	380 10 380GVZ	625.269 In 1888 enthalten / Contained in 1888	(29)
		OM440.970, OM440.980, OM440.985		3483 023 032 ⊕	445 GMFZ445W	625.136 für Fahrzeuge mit Wandlerschaltkupplung / for vehicles with converter and clutch unit	(76)
				1878 003 780	445 24 445GTZ	625.136 für Fahrzeuge mit Wandlerschaltkupplung / for vehicles with converter and clutch unit	(76)

3548							
3548 625.197 625.196 3548 K,S 625.197 625.196 625.149 3548 659.232 625.149	05.92 - 09.96	OM402LA, 442LA		3400 122 601  3482 081 231  1878 080 037  3151 000 278	430 10 MFZ430 430WGTZ KZISZ-5	625.149/196-197	
		OM442LA		3400 124 101  3482 081 232  1878 005 668  3151 000 549	430 10 MFZ430 430WGTZ KZISZ-5	659.232	
			3400 122 601  3482 081 231  1878 080 037  3151 000 278	430 10 MFZ430 430WGTZ KZISZ-5	659.232 Sonderausführung / Special design	(56)	
		OM402LA		1888 063 137	380 GF2/380N	625.149 Nebenantriebs-ID / PTO ID: 4/125 enthält eine Kupplungsscheibe / This part number includes one clutch disc	(48) (66)
			1862 304 033 ▽	380 10 380GV	625.149 Nebenantriebs-ID / PTO ID: 4/125 Lose Kupplungsscheibe / Loose clutch disc	(48) (39)	
			3151 166 031	KZI-6	625.149 Nebenantriebs-ID / PTO ID: 4/125	(48)	
			1882 019 133	380 GF2/380N	625.149 In 1888 enthalten / Contained in 1888	(29)	
			1859 250 101	380 GF2/380	625.149 In 1888 enthalten / Contained in 1888	(29)	
			1862 305 033 △	380 10 380GVZ	625.149 In 1888 enthalten / Contained in 1888	(29)	
3548 S 659.196		OM440		3400 121 601  3488 017 432  1878 634 022  3151 000 547	400 10 MFZ2/400X 400GVZ KZISZ-5	->Chass. K011863 659.196	
				3400 122 901  3482 081 233  1878 002 735  3151 000 278	430 10 MFZ430 430GTZ KZISZ-5	Chass. K011863-> 659.196	
				3483 023 032 ⊕	445 GMFZ445W	659.196 für Fahrzeuge mit Wandlerschaltkupplung / for vehicles with converter and clutch unit	(76)
				1878 003 780	445 24 445GTZ	659.196 für Fahrzeuge mit Wandlerschaltkupplung / for vehicles with converter and clutch unit	(76)

























		CODE					
--	--	------	--	--	---	---	---

MERCEDES-BENZ

3550							
3550 656.215	01.88-	OM442	 3400 124 101 ⊗ 3482 081 232 ⊗ 1878 005 668 ⊙ 3151 000 549	430 10 MFZ430 430WGTZ KZISZ-5	656.215		
			 1888 063 137	380 GF2/380N	656.215 Nebenantriebs-ID / PTO ID: 4/125 enthält eine Kupplungsscheibe / This part number includes one clutch disc	(48) (66)	
			 1862 304 033 ▽	380 10 380GV	656.215 Nebenantriebs-ID / PTO ID: 4/125 Lose Kupplungsscheibe / Loose clutch disc	(48) (39)	
			 3151 166 031	KZI-6	656.215 Nebenantriebs-ID / PTO ID: 4/125	(48)	
			 1882 019 133	380 GF2/380N	656.215 In 1888 enthalten / Contained in 1888	(29)	
			 1859 250 101	380 GF2/380	656.215 In 1888 enthalten / Contained in 1888	(29)	
			 1862 305 033 △	380 10 380GVZ	656.215 In 1888 enthalten / Contained in 1888	(29)	
3550 625.196 659.196 625.037 659.098 625.197 625.137	05.92 - 09.96	OM442LA	 3400 122 601 ⊗ 3482 081 231 ⊗ 1878 080 037 ⊙ 3151 000 278	430 10 MFZ430 430WGTZ KZISZ-5	625.137		
			 3400 121 601 ⊗ 3488 017 432 ⊗ 1878 634 022 ⊙ 3151 000 547	400 10 MFZ2/400X 400GVZ KZISZ-5	->Chass. K011863 659.098/196		
		OM442, 442LA	 3400 122 901 ⊗ 3482 081 233 ⊗ 1878 002 735 ⊙ 3151 000 278	430 10 MFZ430 430GTZ KZISZ-5	Chass. K011864-> 659.098/196		
			 3483 023 032 ⊕	445 GMFZ445W	625.037 659.196 für Fahrzeuge mit Wandlerschaltkupplung / for vehicles with converter and clutch unit	(76)	
			 1878 003 780	445 24 445GTZ	625.037 659.196 für Fahrzeuge mit Wandlerschaltkupplung / for vehicles with converter and clutch unit	(76)	
3550 ,K,S 625.258 625.137 625.259 3550 K 625.259	03.91 - 09.96	OM442LA	 3400 122 601 ⊗ 3482 081 231 ⊗ 1878 080 037 ⊙ 3151 000 278	430 10 MFZ430 430WGTZ KZISZ-5	625.137/258-259		
			 3400 122 901 ⊗ 3482 081 233 ⊗ 1878 002 735 ⊙ 3151 000 278	430 10 MFZ430 430GTZ KZISZ-5	für / for: SA033617-01 625.137/258-259	(68)	
3550 S 659.191		OM442	 3400 121 601 ⊗ 3488 017 432 ⊗ 1878 634 022 ⊙ 3151 000 547	400 10 MFZ2/400X 400GVZ KZISZ-5	->Chass. K011863 659.191		
			 3400 122 901 ⊗ 3482 081 233 ⊗ 1878 002 735 ⊙ 3151 000 278	430 10 MFZ430 430GTZ KZISZ-5	Chass. K011863-> 659.191		
3550 S, 3553 S 625.197 625.196 625.037	05.92 - 09.96	OM442LA	 3400 122 601 ⊗ 3482 081 231 ⊗ 1878 080 037 ⊙ 3151 000 278	430 10 MFZ430 430WGTZ KZISZ-5	625.037/137/196-197/258-259 659.038		
			 3483 023 032 ⊕	445 GMFZ445W	625.037 für Fahrzeuge mit Wandlerschaltkupplung / for vehicles with converter and clutch unit	(76)	
		 1878 003 780	445 24 445GTZ	625.037 für Fahrzeuge mit Wandlerschaltkupplung / for vehicles with converter and clutch unit	(76)		
3553, 3553 L 659.196 659.098	01.94 - 09.96	OM446.920	 3483 023 032 ⊕	445 GMFZ445W	659.196 für Fahrzeuge mit Wandlerschaltkupplung / for vehicles with converter and clutch unit	(76)	
			 1878 003 780	445 24 445GTZ	659.196 für Fahrzeuge mit Wandlerschaltkupplung / for vehicles with converter and clutch unit	(76)	
3553 S 625.197 625.196	04.92 -	OM442LA	 3400 122 601 ⊗ 3482 081 231 ⊗ 1878 080 037 ⊙ 3151 000 278	430 10 MFZ430 430WGTZ KZISZ-5	625.197		







		CODE					
--	--	------	--	--	---	---	---







MERCEDES-BENZ













3636							
3636 624.137		OM422LA, 423		1888 042 009	380 GF2/380	624.137 enthält eine Kupplungsscheibe / This part number includes one clutch disc Sonderausführung / Special design	(66) (56)
				1878 000 968 ▽	380 10 380GTZ	624.137 Lose Kupplungsscheibe / Loose clutch disc Sonderausführung / Special design	(39) (56)
				3151 108 031	KZI-4,5	624.137 Sonderausführung / Special design	(56)
				1882 341 001	380 GF2/380	624.137 In 1888 enthalten / Contained in 1888 Sonderausführung / Special design	(29) (56)
				1859 250 102	380 GF2/380	624.137 In 1888 enthalten / Contained in 1888 Sonderausführung / Special design	(29) (56)
				1878 000 968 △	380 10 380GTZ	624.137 In 1888 enthalten / Contained in 1888 Sonderausführung / Special design	(29) (56)
				1882 346 131 #	420 GF420XN	624.137 für Nebenantrieb / for PTO	(82)
				1878 002 706	420 10 420GTZ	624.137 für Nebenantrieb / for PTO	(82)
				3151 204 001	KZI-6	624.137 für Nebenantrieb / for PTO mit Schmierrohranschluß / with lubricating pipe coupling	(82) (91)
3636 AK 624.137		OM422A, 423		1882 342 134	420 GF420X	624.137	
				1878 002 878	420 10 420GTZ	624.137	
				3151 110 031	KZI-4,5	624.137	
		OM422LA, 423		1882 346 131 #	420 GF420XN	624.137 für Nebenantrieb / for PTO	(82)
				1878 002 706	420 10 420GTZ	624.137 für Nebenantrieb / for PTO	(82)
				3151 204 001	KZI-6	624.137 für Nebenantrieb / for PTO mit Schmierrohranschluß / with lubricating pipe coupling	(82) (91)
3836							
3836 AK 624.339	11.81 - 03.91	OM423.907		1878 002 706	420 10 420GTZ	624.339 für Nebenantrieb / for PTO	(82)
				3151 204 001	KZI-6	624.339 für Nebenantrieb / for PTO mit Schmierrohranschluß / with lubricating pipe coupling	(82) (91)
3844							
3844 ,S 649.196		OM442		1888 055 247	380 GF2/380	649.196 enthält eine Kupplungsscheibe / This part number includes one clutch disc	(66)
				1862 123 131 ▽	380 10 380GV	649.196 Lose Kupplungsscheibe / Loose clutch disc	(39)
				3151 108 031	KZI-4,5	649.196	
				1882 349 003	380 GF2/380	649.196 In 1888 enthalten / Contained in 1888	(29)
				1859 250 100	380 GF2/380	649.196 In 1888 enthalten / Contained in 1888	(29)
				1862 122 132 △	380 10 380GVZ	649.196 In 1888 enthalten / Contained in 1888	(29)
3850							
3850 A 625.392	09.85 - 08.94	OM423.950		3483 023 001 ⊕	445 GMFZ445W	625.392 für Fahrzeuge mit Wandlerschaltkupplung / for vehicles with converter and clutch unit	(76)

		CODE					
--	--	------	--	--	---	---	---

MERCEDES-BENZ





4044							
4044 S 649.196		OM442		1888 055 247	380 GF2/380	649.196 enthält eine Kupplungsscheibe / This part number includes one clutch disc	(66)
				1862 123 131 ▽	380 10 380GV	649.196 Lose Kupplungsscheibe / Loose clutch disc	(39)
				3151 108 031	KZI-4,5	649.196	
				1882 349 003	380 GF2/380	649.196 In 1888 enthalten / Contained in 1888	(29)
				1859 250 100	380 GF2/380	649.196 In 1888 enthalten / Contained in 1888	(29)
				1862 122 132 △	380 10 380GVZ	649.196 In 1888 enthalten / Contained in 1888	(29)



4435								
4435 ,K 625.149 659.038		OM442A		3400 122 601 ● 3482 081 231 ● 1878 080 037 ● 3151 000 278	430 10 MFZ430 430WGTZ KZISZ-5	625.149 659.038		
			OM402LA		1888 063 137	380 GF2/380N	625.149 Nebenantriebs-ID / PTO ID: 4/125 enthält eine Kupplungsscheibe / This part number includes one clutch disc	(48) (66)
					1862 304 033 ▽	380 10 380GV	625.149 Nebenantriebs-ID / PTO ID: 4/125 Lose Kupplungsscheibe / Loose clutch disc	(48) (39)
				3151 166 031	KZI-6	625.149 Nebenantriebs-ID / PTO ID: 4/125	(48)	
				1882 019 133	380 GF2/380N	625.149 In 1888 enthalten / Contained in 1888	(29)	
				1859 250 101	380 GF2/380	625.149 In 1888 enthalten / Contained in 1888	(29)	
				1862 305 033 △	380 10 380GVZ	625.149 In 1888 enthalten / Contained in 1888	(29)	



4436							
4436 AK 624.137 624.237		OM422A, 423		1882 342 134	420 GF420X	624.137/237	
				1878 002 878	420 10 420GTZ	624.137/237	
				3151 110 031	KZI-4,5	624.137/237	
		OM422LA, 423		1888 042 009	380 GF2/380	624.137/237 enthält eine Kupplungsscheibe / This part number includes one clutch disc Sonderausführung / Special design	(66) (56)
				1878 000 968 ▽	380 10 380GTZ	624.137/237 Lose Kupplungsscheibe / Loose clutch disc Sonderausführung / Special design	(39) (56)
				3151 108 031	KZI-4,5	624.137/237 Sonderausführung / Special design	(56)
				1882 341 001	380 GF2/380	624.137/237 In 1888 enthalten / Contained in 1888 Sonderausführung / Special design	(29) (56)
				1859 250 102	380 GF2/380	624.137/237 In 1888 enthalten / Contained in 1888 Sonderausführung / Special design	(29) (56)
				1878 000 968 △	380 10 380GTZ	624.137/237 In 1888 enthalten / Contained in 1888 Sonderausführung / Special design	(29) (56)
				1882 346 131 #	420 GF420XN	624.137/237 für Nebenantrieb / for PTO	(82)
				1878 002 706	420 10 420GTZ	624.137/237 für Nebenantrieb / for PTO	(82)
				3151 204 001	KZI-6	624.137/237 für Nebenantrieb / for PTO mit Schmierrohranschluß / with lubricating pipe coupling	(82) (91)







		CODE				
--	--	------	--	---	---	---



MERCEDES-BENZ

4445						
4445 624.233		OM442A, 443A	 1800 125 301 ⊗ 1882 301 239 ⊗ 1878 002 706 ⊙ 3151 000 375	420 10 GF420 420GTZ KZIS-4	624.233	
			 3482 124 534 ●	430 GMF430	624.233	
		OM442	 1878 000 964	380 10 380GTZ	Getr. / GBox: ZF16S-160 624.233 für Nebenantrieb / for PTO Nebenantriebs-ID / PTO ID: NMV	(82) (48)
		 3151 204 001	KZI-6	Getr. / GBox: ZF16S-160 624.233 für Nebenantrieb / for PTO mit Schmierrohranschluß / with lubricating pipe coupling Nebenantriebs-ID / PTO ID: NMV	(82) (91) (48)	

4635						
4635 659.233 659.237		OM442A	 3400 122 601 ⊗ 3482 081 231 ⊗ 1878 080 037 ⊙ 3151 000 278	430 10 MFZ430 430WGTZ KZISZ-5	659.237	
			 3400 124 101 ⊗ 3482 081 232 ⊗ 1878 005 668 ⊙ 3151 000 549	430 10 MFZ430 430WGTZ KZISZ-5	659.233	
			 3400 122 601 ⊗ 3482 081 231 ⊗ 1878 080 037 ⊙ 3151 000 278	430 10 MFZ430 430WGTZ KZISZ-5	659.233 Sonderausführung / Special design	(56)











































4644						
4644 659.233		OM442LA	 3400 124 101 ⊗ 3482 081 232 ⊗ 1878 005 668 ⊙ 3151 000 549	430 10 MFZ430 430WGTZ KZISZ-5	659.233	
			 3400 122 601 ⊗ 3482 081 231 ⊗ 1878 080 037 ⊙ 3151 000 278	430 10 MFZ430 430WGTZ KZISZ-5	659.233 Sonderausführung / Special design	(56)

4645						
4645 624.233 659.233		OM442A, 443A	 1800 125 301 ⊗ 1882 301 239 ⊗ 1878 002 706 ⊙ 3151 000 375	420 10 GF420 420GTZ KZIS-4	624.233	
			 3482 124 534 ●	430 GMF430	624.233	
			 1878 000 964	380 10 380GTZ	Getr. / GBox: ZF16S-160 624.233 für Nebenantrieb / for PTO Nebenantriebs-ID / PTO ID: NMV	(82) (48)
			 3151 204 001	KZI-6	Getr. / GBox: ZF16S-160 624.233 für Nebenantrieb / for PTO mit Schmierrohranschluß / with lubricating pipe coupling Nebenantriebs-ID / PTO ID: NMV	(82) (91) (48)
		OM443A	 3400 124 101 ⊗ 3482 081 232 ⊗ 1878 005 668 ⊙ 3151 000 549	430 10 MFZ430 430WGTZ KZISZ-5	659.233	
		 3400 122 601 ⊗ 3482 081 231 ⊗ 1878 080 037 ⊙ 3151 000 278	430 10 MFZ430 430WGTZ KZISZ-5	659.233 Sonderausführung / Special design	(56)	

4648						
4648 659.232/233		OM442LA, 443A	 3400 124 101 ⊗ 3482 081 232 ⊗ 1878 005 668 ⊙ 3151 000 549	430 10 MFZ430 430WGTZ KZISZ-5	659.232-233	
			 3400 122 601 ⊗ 3482 081 231 ⊗ 1878 080 037 ⊙ 3151 000 278	430 10 MFZ430 430WGTZ KZISZ-5	659.232-233 Sonderausführung / Special design	(56)























		CODE				
--	--	------	--	---	---	---

MERCEDES-BENZ

4844							
4844 659.237 659.242 4844 ,K 625.259 625.269 625.258 659.237 4844 K 625.258	12.91 - 08.94	OM442LA	 3400 122 601  3482 081 231  1878 080 037  3151 000 278	430 10 MFZ430 430WGTZ KZISZ-5	625.258-259/269 659.237		
	03.91 - 09.96		 3400 122 901  3482 081 233  1878 002 735  3151 000 278	430 10 MFZ430 430GTZ KZISZ-5	für / for: SA033617-01 625.258-259/269	(68)	
			 1888 063 137	380 GF2/380N	625.258-259/269 Nebenantriebs-ID / PTO ID: 4/125 enthält eine Kupplungsscheibe / This part number includes one clutch disc	(48) (66)	
			 1862 304 033 ▽	380 10 380GV	625.258-259/269 Nebenantriebs-ID / PTO ID: 4/125 Lose Kupplungsscheibe / Loose clutch disc	(48) (39)	
			 3151 166 031	KZI-6	625.258-259/269 Nebenantriebs-ID / PTO ID: 4/125	(48)	
			 1882 019 133	380 GF2/380N	625.258-259/269 In 1888 enthalten / Contained in 1888	(29)	
			 1859 250 101	380 GF2/380	625.258-259/269 In 1888 enthalten / Contained in 1888	(29)	
			 1862 305 033 △	380 10 380GVZ	625.258-259/269 In 1888 enthalten / Contained in 1888	(29)	
4844 S 649.196		OM442	 1888 055 247	380 GF2/380	649.196 enthält eine Kupplungsscheibe / This part number includes one clutch disc	(66)	
			 1862 123 131 ▽	380 10 380GV	649.196 Lose Kupplungsscheibe / Loose clutch disc	(39)	
			 3151 108 031	KZI-4,5	649.196		
			 1882 349 003	380 GF2/380	649.196 In 1888 enthalten / Contained in 1888	(29)	
			 1859 250 100	380 GF2/380	649.196 In 1888 enthalten / Contained in 1888	(29)	
			 1862 122 132 △	380 10 380GVZ	649.196 In 1888 enthalten / Contained in 1888	(29)	
4850							
4850 625.269 625.258/259 659.233		OM442LA	 3400 122 601  3482 081 231  1878 080 037  3151 000 278	430 10 MFZ430 430WGTZ KZISZ-5	625.258-259/269		
			 3400 122 901  3482 081 233  1878 002 735  3151 000 278	430 10 MFZ430 430GTZ KZISZ-5	für / for: SA033617-01 625.258-259/269	(68)	
			 1888 063 137	380 GF2/380N	625.258-259/269 Nebenantriebs-ID / PTO ID: 4/125 enthält eine Kupplungsscheibe / This part number includes one clutch disc	(48) (66)	
			 1862 304 033 ▽	380 10 380GV	625.258-259/269 Nebenantriebs-ID / PTO ID: 4/125 Lose Kupplungsscheibe / Loose clutch disc	(48) (39)	
			 3151 166 031	KZI-6	625.258-259/269 Nebenantriebs-ID / PTO ID: 4/125	(48)	
			 1882 019 133	380 GF2/380N	625.258-259/269 In 1888 enthalten / Contained in 1888	(29)	
			 1859 250 101	380 GF2/380	625.258-259/269 In 1888 enthalten / Contained in 1888	(29)	
			 1862 305 033 △	380 10 380GVZ	625.258-259/269 In 1888 enthalten / Contained in 1888	(29)	
			OM443A	 3400 124 101  3482 081 232  1878 005 668  3151 000 549	430 10 MFZ430 430WGTZ KZISZ-5	659.233	
		 3400 122 601  3482 081 231  1878 080 037  3151 000 278		430 10 MFZ430 430WGTZ KZISZ-5	659.233 Sonderausführung / Special design	(56)	

		CODE				
--	--	------	--	---	---	---

MERCEDES-BENZ

4853							
4853 625.259 625.269	OM442LA	 3400 122 601 ⊗ 3482 081 231 ⊗ 1878 080 037 ⊙ 3151 000 278	430 10 MFZ430 430WGTZ KZISZ-5	625.259/269			
		 3400 122 901 ⊗ 3482 081 233 ⊗ 1878 002 735 ⊙ 3151 000 278	430 10 MFZ430 430GTZ KZISZ-5	für / for: SA033617-01 625.259/269	(68)		
		 1888 063 137	380 GF2/380N	625.259/269 Nebenantriebs-ID / PTO ID: 4/125 enthält eine Kupplungsscheibe / This part number includes one clutch disc	(48) (66)		
		 1862 304 033 ▽	380 10 380GV	625.259/269 Nebenantriebs-ID / PTO ID: 4/125 Lose Kupplungsscheibe / Loose clutch disc	(48) (39)		
		 3151 166 031	KZI-6	625.259/269 Nebenantriebs-ID / PTO ID: 4/125	(48)		
		 1882 019 133	380 GF2/380N	625.259/269 In 1888 enthalten / Contained in 1888	(29)		
		 1859 250 101	380 GF2/380	625.259/269 In 1888 enthalten / Contained in 1888	(29)		
		 1862 305 033 △	380 10 380GVZ	625.259/269 In 1888 enthalten / Contained in 1888	(29)		
5035							
5035 659.232	OM442A	 3400 124 101 ⊗ 3482 081 232 ⊗ 1878 005 668 ⊙ 3151 000 549	430 10 MFZ430 430WGTZ KZISZ-5	659.232			
		 3400 122 601 ⊗ 3482 081 231 ⊗ 1878 080 037 ⊙ 3151 000 278	430 10 MFZ430 430WGTZ KZISZ-5	659.232 Sonderausführung / Special design	(56)		
5038							
5038 ,AK 625.269	OM442LA	 3400 122 601 ⊗ 3482 081 231 ⊗ 1878 080 037 ⊙ 3151 000 278	430 10 MFZ430 430WGTZ KZISZ-5	625.269			
		 3400 122 901 ⊗ 3482 081 233 ⊗ 1878 002 735 ⊙ 3151 000 278	430 10 MFZ430 430GTZ KZISZ-5	für / for: SA033617-01 625.269	(68)		
		 1888 063 137	380 GF2/380N	625.269 Nebenantriebs-ID / PTO ID: 4/125 enthält eine Kupplungsscheibe / This part number includes one clutch disc	(48) (66)		
		 1862 304 033 ▽	380 10 380GV	625.269 Nebenantriebs-ID / PTO ID: 4/125 Lose Kupplungsscheibe / Loose clutch disc	(48) (39)		
		 3151 166 031	KZI-6	625.269 Nebenantriebs-ID / PTO ID: 4/125	(48)		
		 1882 019 133	380 GF2/380N	625.269 In 1888 enthalten / Contained in 1888	(29)		
		 1859 250 101	380 GF2/380	625.269 In 1888 enthalten / Contained in 1888	(29)		
		 1862 305 033 △	380 10 380GVZ	625.269 In 1888 enthalten / Contained in 1888	(29)		
5248							
5248 K 659.196	OM440	 3400 121 601 ⊗ 3488 017 432 ⊗ 1878 634 022 ⊙ 3151 000 547	400 10 MFZ2/400X 400GVZ KZISZ-5	->Chass. K011863 659.196			
		 3400 122 901 ⊗ 3482 081 233 ⊗ 1878 002 735 ⊙ 3151 000 278	430 10 MFZ430 430GTZ KZISZ-5	Chass. K011864-> 659.196			
		 3483 023 032 ⊕	445 GMFZ445W	659.196 für Fahrzeuge mit Wandlerschaltkupplung / for vehicles with converter and clutch unit	(76)		
		 1878 003 780	445 24 445GTZ	659.196 für Fahrzeuge mit Wandlerschaltkupplung / for vehicles with converter and clutch unit	(76)		

		CODE				
--	--	------	--	---	---	---

MZKT



LKW						
LKW		Deutz		3482 083 032	430 MFZ430	Getr. / GBox: ZF 16S-251
				3151 000 034	KZISZ-5	Getr. / GBox: ZF 16S-251







NISSAN















CABSTAR 10.06 - 07.11						
28.11	10.06 -	YD25ETI,		1863 600 116	GR-2	
35.13	09.06 - 03.09	YD25DDTi,				
35.15	10.06 -	ZD30DDTi,				
45.13	10.06 -	ZD30HHD-5,				
45.15	10.06 -	ZD30				

CABSTAR E 10.98 - 10.06						
105.35, 110.35	10.98 - 10.06	BD-30Ti		3000 951 373 ■	242 10	Getr. / GBox: M5-25
110.45	10.98 - 10.06					Nabenprofil / Hub Profile: 23,1x28,7-10N (46)

ÖSTERREICHISCHE AUTOMOBILFABRIK (ÖAF)





















16...						
16.192 H, HA, F				1882 110 532 #	350 GF350	
				1878 005 367	350 10 350WGTZ	
				3151 000 395	KZIS-4	

17...						
17.192 E49	01.88 -	D0826LF, GF		3482 017 035	380 GMF380	
				1878 000 957	380 10 380GTZ	
				3151 000 395	KZIS-4	
17.232 E49	01.89 -	D0826LF02, 06		3482 017 035	380 GMF380	
				1878 000 957	380 10 380GTZ	
				3151 000 395	KZIS-4	

18...						
18.373 E61		D2866LF21		3400 122 201  3482 083 032  1878 004 832  3151 000 034	430 10 MFZ430 430WGTZ KZISZ-5	
				3482 114 031	430 GMFZ430N	für Fahrzeuge mit Nebenantrieb / for vehicles with PTO (73)
				1878 004 832	430 10 430WGTZ	für Nebenantrieb / for PTO (82)
				3151 263 031	KZIZ-6	für Nebenantrieb / for PTO (82)
18.403 E61		D2866LF20		3400 122 201  3482 083 032  1878 004 832  3151 000 034	430 10 MFZ430 430WGTZ KZISZ-5	
				3482 114 031	430 GMFZ430N	für Fahrzeuge mit Nebenantrieb / for vehicles with PTO (73)
				1878 004 832	430 10 430WGTZ	für Nebenantrieb / for PTO (82)
				3151 263 031	KZIZ-6	für Nebenantrieb / for PTO (82)









		CODE					
--	--	------	--	--	---	---	---







ÖSTERREICHISCHE AUTOMOBILFABRIK (ÖAF)





18...								
18.423 E61		D2866LF22		3400 122 201 ⊗ 3482 083 032 ⊗ 1878 004 832 ⊙ 3151 000 034	430 10 MFZ430 430WGTZ KZISZ-5			
				3482 114 031	430 GMFZ430N	für Fahrzeuge mit Nebenantrieb / for vehicles with PTO für Nebenantrieb / for PTO	(73) (82)	
				1878 004 832	430 10 430WGTZ	für Nebenantrieb / for PTO	(82)	
				3151 263 031	KZIZ-6	für Nebenantrieb / for PTO	(82)	
18.463 E61		D2876LF02		3400 122 201 ⊗ 3482 083 032 ⊗ 1878 004 832 ⊙ 3151 000 034	430 10 MFZ430 430WGTZ KZISZ-5			
				3482 114 031	430 GMFZ430N	für Fahrzeuge mit Nebenantrieb / for vehicles with PTO für Nebenantrieb / for PTO	(73) (82)	
				1878 004 832	430 10 430WGTZ	für Nebenantrieb / for PTO	(82)	
				3151 263 031	KZIZ-6	für Nebenantrieb / for PTO	(82)	
19...								
19.192 H, HA,				1882 110 532 #	350 GF350			
				1878 005 367	350 10 350WGTZ			
				3151 000 395	KZIS-4			
19.230 H, HA, F				3151 000 395	KZIS-4			
19.256 H, HA, F 19.304 F				3482 124 541	430 GMF430			
				1882 330 032 ●#	420 GF420			
				1878 001 155 ▲#	420 10 420WGTZ			
				3151 000 395	KZIS-4			
19.273 E52	01.94-	D2865		3400 122 301 ⊗ 3482 083 032 ⊗ 1878 080 034 ⊙ 3151 000 034	430 10 MFZ430 430WGTZ KZISZ-5			
19.293 E52	01.94-							
19.323 E52	01.94-							
19.344 E52	01.94-							
19.344 E52	01.94-							
19.373 E61,62 19.404 E61,62 19.423 E61,62 19.464 E61,62		D2866LF21, D2866LF20, D2866LF22, D2876LF02		3400 122 201 ⊗ 3482 083 032 ⊗ 1878 004 832 ⊙ 3151 000 034	430 10 MFZ430 430WGTZ KZISZ-5			
				3400 700 327 ⊗ 3482 114 031 ⊗ 1878 004 832 ⊙ 3151 263 031	430 10 GMFZ430N 430WGTZ KZIZ-6	für Fahrzeuge mit Nebenantrieb / for vehicles with PTO für Nebenantrieb / for PTO	(73) (82)	
19.463 E61,62 19.464 E61,62	01.95-	D2866LF		3400 700 327 ⊗ 3482 114 031 ⊗ 1878 004 832 ⊙ 3151 263 031	430 10 GMFZ430N 430WGTZ KZIZ-6	für Fahrzeuge mit Nebenantrieb / for vehicles with PTO für Nebenantrieb / for PTO	(73) (82)	
	01.95-							







		CODE				
--	--	------	--	---	---	---

ÖSTERREICHISCHE AUTOMOBILFABRIK (ÖAF)

21...						
21.273 E52	01.94-	D2865		3400 122 301 ⊗ 3482 083 032 ⊗ 1878 080 034 ⊙ 3151 000 034	430 10 MFZ430 430WGTZ KZISZ-5	
21.293 E52	01.94-			3482 114 031	430 GMFZ430N	für Fahrzeuge mit Nebenantrieb / for vehicles with PTO (73) für Nebenantrieb / for PTO (82)
21.323 E52	01.94-			1862 441 131 #	430 10 430WGTZ	für Nebenantrieb / for PTO (82)
21.343 E52	01.94-			3151 000 034	KZISZ-5	für Nebenantrieb / for PTO (82)
21.373 E62	01.94-	D2866LF21		3400 122 301 ⊗ 3482 083 032 ⊗ 1878 080 034 ⊙ 3151 000 034	430 10 MFZ430 430WGTZ KZISZ-5	
21.403 E62	01.94-			3482 114 031	430 GMFZ430N	für Fahrzeuge mit Nebenantrieb / for vehicles with PTO (73) für Nebenantrieb / for PTO (82)
21.423 E62	01.94-			1862 441 131 #	430 10 430WGTZ	für Nebenantrieb / for PTO (82)
21.463 E62	01.94-			3151 000 034	KZISZ-5	für Nebenantrieb / for PTO (82)











22...						
22.192 FN				1882 110 532 #	350 GF350	
				1878 005 367	350 10 350WGTZ	
				3151 000 395	KZIS-4	
22.230 HN, HNA, FN				3151 000 395	KZIS-4	
22.256 HN, HNA, FN				3482 124 541	430 GMF430	
22.304 FN				1882 330 032 ●#	420 GF420	
				1878 001 155 ▲#	420 10 420WGTZ	
				3151 000 395	KZIS-4	









24...						
24.273 E53		D2865		3400 122 301 ⊗ 3482 083 032 ⊗ 1878 080 034 ⊙ 3151 000 034	430 10 MFZ430 430WGTZ KZISZ-5	
24.293 E53				3482 114 031	430 GMFZ430N	für Fahrzeuge mit Nebenantrieb / for vehicles with PTO (73) für Nebenantrieb / for PTO (82)
24.323 E53				1862 441 131 #	430 10 430WGTZ	für Nebenantrieb / for PTO (82)
24.343 E53				3151 263 031	KZIZ-6	für Nebenantrieb / for PTO (82)







26...						
26.273 E53,69		D2865, 2866		3400 122 301 ⊗ 3482 083 032 ⊗ 1878 080 034 ⊙ 3151 000 034	430 10 MFZ430 430WGTZ KZISZ-5	
26.293 E53,69				3482 114 031	430 GMFZ430N	für Fahrzeuge mit Nebenantrieb / for vehicles with PTO (73) für Nebenantrieb / for PTO (82)
26.323 E53,69				1862 441 131 #	430 10 430WGTZ	für Nebenantrieb / for PTO (82)
26.343 E53,69				3151 263 031	KZIZ-6	für Nebenantrieb / for PTO (82)
26.352 E76,78	01.94-	D2866		3400 122 201 ⊗ 3482 083 032 ⊗ 1878 004 832 ⊙ 3151 000 034	430 10 MFZ430 430WGTZ KZISZ-5	
26.482 E76,78	01.94-			3400 700 327 ⊗ 3482 114 031 ⊗ 1878 004 832 ⊙ 3151 263 031	430 10 GMFZ430N 430WGTZ KZIZ-6	für Fahrzeuge mit Nebenantrieb / for vehicles with PTO (73) für Nebenantrieb / for PTO (82)

		CODE					
--	--	------	--	--	---	---	---





ÖSTERREICHISCHE AUTOMOBILFABRIK (ÖAF)











26...							
26.373 E72	01.94-	D2866		3400 122 301 ⊗ 3482 083 032 ⊗ 1878 080 034 ◊ 3151 000 034	430 10 MFZ430 430WGTZ KZISZ-5		
26.404 E69,72	01.94-						
26.423 E69,72	01.94-			3482 114 031	430 GMFZ430N	für Fahrzeuge mit Nebenantrieb / for vehicles with PTO für Nebenantrieb / for PTO	(73) (82)
26.464 E69,72	01.94-			1862 441 131 #	430 10 430WGTZ	für Nebenantrieb / for PTO	(82)
				3151 263 031	KZIZ-6	für Nebenantrieb / for PTO	(82)
26.463 E69	01.94-	D2866		3400 122 301 ⊗ 3482 083 032 ⊗ 1878 080 034 ◊ 3151 000 034	430 10 MFZ430 430WGTZ KZISZ-5		
				3482 114 031	430 GMFZ430N	für Fahrzeuge mit Nebenantrieb / for vehicles with PTO für Nebenantrieb / for PTO	(73) (82)
				1862 441 131 #	430 10 430WGTZ	für Nebenantrieb / for PTO	(82)
				3151 263 031	KZIZ-6	für Nebenantrieb / for PTO	(82)
				3483 023 003 ⊕	445 GMFZ445W	für Fahrzeuge mit Wandlerschaltkupplung / for vehicles with converter and clutch unit	(76)
				1878 051 801	445 24 445GTZC	für Fahrzeuge mit Wandlerschaltkupplung / for vehicles with converter and clutch unit	(76)







27...							
27.273 E53,69		D2865, 2866		3400 122 301 ⊗ 3482 083 032 ⊗ 1878 080 034 ◊ 3151 000 034	430 10 MFZ430 430WGTZ KZISZ-5	03.1996->	
27.293 E53,69							
27.323 E53,69				3482 114 031	430 GMFZ430N	für Fahrzeuge mit Nebenantrieb / for vehicles with PTO für Nebenantrieb / for PTO	(73) (82)
27.343 E53,69				1862 441 131 #	430 10 430WGTZ	für Nebenantrieb / for PTO	(82)
27.403 E53,69,72				3151 263 031	KZIZ-6	für Nebenantrieb / for PTO	(82)
27.423 E53,69,72							
27.463 E53,69,72							
27.373 E72		D2866		3400 122 301 ⊗ 3482 083 032 ⊗ 1878 080 034 ◊ 3151 000 034	430 10 MFZ430 430WGTZ KZISZ-5	01.1995->	
27.403 E69,72							
27.423 E69,72				3482 114 031	430 GMFZ430N	für Fahrzeuge mit Nebenantrieb / for vehicles with PTO für Nebenantrieb / for PTO	(73) (82)
27.463 E69,72				1862 441 131 #	430 10 430WGTZ	für Nebenantrieb / for PTO	(82)
				3151 263 031	KZIZ-6	für Nebenantrieb / for PTO	(82)

28...							
28.273 E69		D2866		3400 122 301 ⊗ 3482 083 032 ⊗ 1878 080 034 ◊ 3151 000 034	430 10 MFZ430 430WGTZ KZISZ-5	01.1994->	
28.403 E69							
28.423 E69				3482 114 031	430 GMFZ430N	für Fahrzeuge mit Nebenantrieb / for vehicles with PTO für Nebenantrieb / for PTO	(73) (82)
28.463 E69				1862 441 131 #	430 10 430WGTZ	für Nebenantrieb / for PTO	(82)
				3151 263 031	KZIZ-6	für Nebenantrieb / for PTO	(82)
				3483 023 003 ⊕	445 GMFZ445W	für Fahrzeuge mit Wandlerschaltkupplung / for vehicles with converter and clutch unit	(76)
				1878 051 801	445 24 445GTZC	für Fahrzeuge mit Wandlerschaltkupplung / for vehicles with converter and clutch unit	(76)

ÖSTERREICHISCHE AUTOMOBILFABRIK (ÖAF)

















































30...						
30.230 HD, HDA				3151 000 395	KZIS-4	
30.256 HD, HDA				3482 124 541	430 GMF430	
				1882 330 032 #	420 GF420	
				1878 001 155 ▲#	420 10 420WGTZ	
				3151 000 395	KZIS-4	

32...							
32.292 E15,17,18,26	01.88 -	D2866LF		3400 127 601 ● 3482 078 133 ● 1862 364 031 ● 3151 000 034	400 10 MFZ400 400WGVZ KZISZ-5	Nabenprofil / Hub Profile: 2"-10N Je nach Kundenwunsch mit unterschiedlicher Kupplung / Equipped with different clutch according to customer requirement	(46) (33)
	01.88 -			3400 122 201 ● 3482 083 032 ● 1878 004 832 ● 3151 000 034	430 10 MFZ430 430WGTZ KZISZ-5	Je nach Kundenwunsch mit unterschiedlicher Kupplung / Equipped with different clutch according to customer requirement	(33)
32.332 E15,17,18,26	01.88 -	D2865, D2866, LF, KF		1882 017 131	420 GF420XN	Nebenantriebs-ID / PTO ID: 130	(48)
	01.88 -			1878 086 941	420 10 420WGTZ	Nebenantriebs-ID / PTO ID: 130	(48)
32.362 E12,15,17,18	01.88 -	D2865, D2866, LF, KF		3400 127 601 ● 3482 078 133 ● 1862 364 031 ● 3151 000 034	400 10 MFZ400 400WGVZ KZISZ-5	Nabenprofil / Hub Profile: 2"-10N Je nach Kundenwunsch mit unterschiedlicher Kupplung / Equipped with different clutch according to customer requirement	(46) (33)
				3400 122 201 ● 3482 083 032 ● 1878 004 832 ● 3151 000 034	430 10 MFZ430 430WGTZ KZISZ-5	Je nach Kundenwunsch mit unterschiedlicher Kupplung / Equipped with different clutch according to customer requirement	(33)
				1882 017 131	420 GF420XN	Nebenantriebs-ID / PTO ID: 130	(48)
				1878 086 941	420 10 420WGTZ	Nebenantriebs-ID / PTO ID: 130	(48)
				3483 023 001 ⊕	445 GMFZ445W	für Fahrzeuge mit Wandlerschaltkupplung / for vehicles with converter and clutch unit	(76)
				1878 051 801	445 24 445GTZC	für Fahrzeuge mit Wandlerschaltkupplung / for vehicles with converter and clutch unit	(76)
32.422 E15,17,18	01.88 -	D2866LF, KF		3400 122 201 ● 3482 083 032 ● 1878 004 832 ● 3151 000 034	430 10 MFZ430 430WGTZ KZISZ-5		

33...							
33.273 E69 33.403 E69 33.423 E69 33.463 E69		D2866		3400 122 301 ● 3482 083 032 ● 1878 080 034 ● 3151 000 034	430 10 MFZ430 430WGTZ KZISZ-5	01.1994->	
				3482 114 031	430 GMFZ430N	für Fahrzeuge mit Nebenantrieb / for vehicles with PTO	(73)
				1862 441 131 #	430 10 430WGTZ	für Nebenantrieb / for PTO	(82)
				3151 263 031	KZIZ-6	für Nebenantrieb / for PTO	(82)
				3483 023 003 ⊕	445 GMFZ445W	für Fahrzeuge mit Wandlerschaltkupplung / for vehicles with converter and clutch unit	(76)
				1878 051 801	445 24 445GTZC	für Fahrzeuge mit Wandlerschaltkupplung / for vehicles with converter and clutch unit	(76)

















































		CODE					
--	--	------	--	--	---	---	---









ÖSTERREICHISCHE AUTOMOBILFABRIK (ÖAF)

35...								
35.292 E15,17,18,26 35.332 E14,15,17,18,26 35.362 E15,17,18 35.372 E15,17,18 35.422 E15,17,18	01.88-	D2866LF		3400 127 601  3482 078 133  1862 364 031  3151 000 034	400 10 MFZ400 400WGVZ KZISZ-5	Nabenprofil / Hub Profile: 2"-10N Je nach Kundenwunsch mit unterschiedlicher Kupplung / Equipped with different clutch according to customer requirement	(46) (33)	
	01.88-			3400 122 201  3482 083 032  1878 004 832  3151 000 034	430 10 MFZ430 430WGTZ KZISZ-5	Je nach Kundenwunsch mit unterschiedlicher Kupplung / Equipped with different clutch according to customer requirement	(33)	
	01.88-	D2865, 2866LF, KF		1882 017 131	420 GF420XN	Nebenantriebs-ID / PTO ID: 130	(48)	
	01.88-			1878 086 941	420 10 420WGTZ	Nebenantriebs-ID / PTO ID: 130	(48)	
	35.322 E15	01.89-07.97	D2866LF		3400 127 601  3482 078 133  1862 364 031  3151 000 034	400 10 MFZ400 400WGVZ KZISZ-5	Nabenprofil / Hub Profile: 2"-10N Je nach Kundenwunsch mit unterschiedlicher Kupplung / Equipped with different clutch according to customer requirement	(46) (33)
					3400 122 201  3482 083 032  1878 004 832  3151 000 034	430 10 MFZ430 430WGTZ KZISZ-5	Je nach Kundenwunsch mit unterschiedlicher Kupplung / Equipped with different clutch according to customer requirement	(33)
D2865, 2866LF, KF				1882 017 131	420 GF420XN	Nebenantriebs-ID / PTO ID: 130	(48)	
				1878 086 941	420 10 420WGTZ	Nebenantriebs-ID / PTO ID: 130	(48)	
				3483 023 001 ⊕	445 GMFZ445W	für Fahrzeuge mit Wandlerschaltkupplung / for vehicles with converter and clutch unit	(76)	
				1878 051 801	445 24 445GTZC	für Fahrzeuge mit Wandlerschaltkupplung / for vehicles with converter and clutch unit	(76)	
35.373 E68 35.403 E68 35.423 E68 35.463 E68	01.94-	D2866LF21, D2866LF20, D2866LF22, D2876LF02		3400 122 301  3482 083 032  1878 080 034  3151 000 034	430 10 MFZ430 430WGTZ KZISZ-5	06.1996->		
	01.94-			3400 700 327  3482 114 031  1878 004 832  3151 263 031	430 10 GMFZ430N 430WGTZ KZIZ-6	für Fahrzeuge mit Nebenantrieb / for vehicles with PTO	(73)	
	01.94-			3483 023 003 ⊕	445 GMFZ445W	für Fahrzeuge mit Wandlerschaltkupplung / for vehicles with converter and clutch unit	(76)	
	01.94-			1878 051 801	445 24 445GTZC	für Fahrzeuge mit Wandlerschaltkupplung / for vehicles with converter and clutch unit	(76)	
36...								
36.372 E26 36.422 E26	01.90-	D2866LF		3400 122 201  3482 083 032  1878 004 832  3151 000 034	430 10 MFZ430 430WGTZ KZISZ-5			
	01.90-			3483 023 001 ⊕	445 GMFZ445W	für Fahrzeuge mit Wandlerschaltkupplung / for vehicles with converter and clutch unit	(76)	
				1878 051 801	445 24 445GTZC	für Fahrzeuge mit Wandlerschaltkupplung / for vehicles with converter and clutch unit	(76)	
37...								
37.373 E68 37.403 E68 37.423 E68 37.463 E68		D2866		3400 122 201  3482 083 032  1878 004 832  3151 000 034	430 10 MFZ430 430WGTZ KZISZ-5			
				3400 700 327  3482 114 031  1878 004 832  3151 263 031	430 10 GMFZ430N 430WGTZ KZIZ-6	für Fahrzeuge mit Nebenantrieb / for vehicles with PTO	(73) (82)	
				3483 023 003 ⊕	445 GMFZ445W	für Fahrzeuge mit Wandlerschaltkupplung / for vehicles with converter and clutch unit	(76)	
				1878 051 801	445 24 445GTZC	für Fahrzeuge mit Wandlerschaltkupplung / for vehicles with converter and clutch unit	(76)	

		CODE					
--	--	------	--	--	---	---	---





ÖSTERREICHISCHE AUTOMOBILFABRIK (ÖAF)



41...								
41.292 E15,17,18,26 41.332 E15,17,18,26 41.362 E12,15,17,18,26 41.372 E12,15,17,18,26 41.422 E12,15,17,18	01.88-	D2866LF		3400 127 601  3482 078 133  1862 364 031  3151 000 034	400 10 MFZ400 400WGVZ KZISZ-5	Nabenprofil / Hub Profile: 2"-10N Je nach Kundenwunsch mit unterschiedlicher Kupplung / Equipped with different clutch according to customer requirement	(46) (33)	
	01.88-			3400 122 201  3482 083 032  1878 004 832  3151 000 034	430 10 MFZ430 430WGTZ KZISZ-5	Je nach Kundenwunsch mit unterschiedlicher Kupplung / Equipped with different clutch according to customer requirement	(33)	
	01.88-	D2865, 2866LF, KF		1882 017 131	420 GF420XN	Nebenantriebs-ID / PTO ID: 130	(48)	
	01.88-			1878 086 941	420 10 420WGTZ	Nebenantriebs-ID / PTO ID: 130	(48)	
	41.322 E15	01.89-07.97	D2866LF		3400 127 601  3482 078 133  1862 364 031  3151 000 034	400 10 MFZ400 400WGVZ KZISZ-5	Nabenprofil / Hub Profile: 2"-10N Je nach Kundenwunsch mit unterschiedlicher Kupplung / Equipped with different clutch according to customer requirement	(46) (33)
				3400 122 201  3482 083 032  1878 004 832  3151 000 034	430 10 MFZ430 430WGTZ KZISZ-5	Je nach Kundenwunsch mit unterschiedlicher Kupplung / Equipped with different clutch according to customer requirement	(33)	
			D2865, 2866LF, KF		1882 017 131	420 GF420XN	Nebenantriebs-ID / PTO ID: 130	(48)
					1878 086 941	420 10 420WGTZ	Nebenantriebs-ID / PTO ID: 130	(48)
						3483 023 001 ⊕	445 GMFZ445W	für Fahrzeuge mit Wandlerschaltkupplung / for vehicles with converter and clutch unit
				1878 051 801	445 24 445GTZC	für Fahrzeuge mit Wandlerschaltkupplung / for vehicles with converter and clutch unit	(76)	
41.373 E68,78 41.403 E68,78 41.423 E68,78 41.463 E68,78		D2866		3400 122 201  3482 083 032  1878 004 832  3151 000 034	430 10 MFZ430 430WGTZ KZISZ-5	E68		
				3400 700 327  3482 114 031  1878 004 832  3151 263 031	430 10 GMFZ430N 430WGTZ KZIZ-6	für Fahrzeuge mit Nebenantrieb / for vehicles with PTO	(73)	
				3400 122 201  3482 083 032  1878 004 832  3151 000 034	430 10 MFZ430 430WGTZ KZISZ-5	06.1996-> E78	(82)	
			D2866LF21		3400 122 301  3482 083 032  1878 080 034  3151 000 034	430 10 MFZ430 430WGTZ KZISZ-5	06.1996-> E68	
41.462 E12 41.502 E12	01.85-	D2840LF		3400 121 901  3488 017 333  1862 303 031  3151 000 034	400 10 MFZ2/400X 400WGVZ KZISZ-5	für Fahrzeuge mit Zweischeibenkupplung / for vehicles with double disc clutch	(77)	
	01.85-			3400 122 201  3482 083 032  1878 004 832  3151 000 034	430 10 MFZ430 430WGTZ KZISZ-5	Je nach Kundenwunsch mit unterschiedlicher Kupplung / Equipped with different clutch according to customer requirement	(33)	
				3483 023 001 ⊕	445 GMFZ445W	für Fahrzeuge mit Wandlerschaltkupplung / for vehicles with converter and clutch unit	(76)	
				1878 051 801	445 24 445GTZC	für Fahrzeuge mit Wandlerschaltkupplung / for vehicles with converter and clutch unit	(76)	

42..							
42.373 E78 42.403 E78 42.423 E78 42.463 E78	01.94-	D2866		3400 122 201  3482 083 032  1878 004 832  3151 000 034	430 10 MFZ430 430WGTZ KZISZ-5	06.1996->	
	01.94-			3400 700 327  3482 114 031  1878 004 832  3151 263 031	430 10 GMFZ430N 430WGTZ KZIZ-6	für Fahrzeuge mit Nebenantrieb / for vehicles with PTO	(73)
	01.94-						für Nebenantrieb / for PTO

		CODE				
--	--	------	--	---	---	---



ÖSTERREICHISCHE AUTOMOBILFABRIK (ÖAF)

47...							
47.292 E15,17,18,26	01.88-	D2865, 2866LF, KF		3400 127 601 ⊗ 3482 078 133 ⊗ 1862 364 031 ⊙ 3151 000 034	400 10 MFZ400 400WGVZ KZISZ-5	Nabenprofil / Hub Profile: 2"-10N Je nach Kundenwunsch mit unterschiedlicher Kupplung / Equipped with different clutch according to customer requirement	(46) (33)
47.332 E15,17,18	01.88-			3400 122 201 ⊗ 3482 083 032 ⊗ 1878 004 832 ⊙ 3151 000 034	430 10 MFZ430 430WGTZ KZISZ-5	Je nach Kundenwunsch mit unterschiedlicher Kupplung / Equipped with different clutch according to customer requirement	(33)
47.362 E12,15,17,18	01.88-			1882 017 131	420 GF420XN	Nebenantriebs-ID / PTO ID: 130	(48)
				1878 086 941	420 10 420WGTZ	Nebenantriebs-ID / PTO ID: 130	(48)

48...							
48.372 E17,18	01.89-	D2866LF, KF		3400 122 201 ⊗ 3482 083 032 ⊗ 1878 004 832 ⊙ 3151 000 034	430 10 MFZ430 430WGTZ KZISZ-5		
48.402 E18	01.89-			1882 017 131	420 GF420XN	für Nebenantrieb / for PTO	(82)
48.422 E17,18	01.89-			1878 086 941	420 10 420WGTZ	für Nebenantrieb / for PTO	(82)

E 2000							
26.414.DFARC E40	01.97 - 03.04	D2866LF03, D2866LF25		3400 122 201 ⊗ 3482 083 032 ⊗ 1878 004 832 ⊙ 3151 000 034	430 10 MFZ430 430WGTZ KZISZ-5	Getr. / GBox: ZF / EATON	
26.414.DFRC E40	01.97 - 03.04						
26.464.DFARC E40	01.97 - 03.04						
26.464.DFLRS E40	01.97 - 03.04						

F...							
FKD -160				1878 001 074	350 10 350GTZ		
				3151 000 395	KZIS-4		

K...							
K 16-180E				1878 001 074	350 10 350GTZ		
				3151 000 395	KZIS-4		
KA 200				1882 325 134	380 G380		



L...							
L 200 L 200 /1-3 LA 200 LA 200 /1 A LA 200 /1-2				1882 325 134	380 G380		

O...							
ORZT 66 L				1861 206 211 #	420 10 420GS		
				1863 600 123	GR-4	mit Anlauftring / with thrust ring	(88)

S...							
SAF 200 /38 SAFD 200 /33 SF 200 /33 SF 200 /36				1882 325 134	380 G380		







		CODE				
--	--	------	--	---	---	---





















ÖSTERREICHISCHE AUTOMOBILFABRIK (ÖAF)

T...						
TSH 158				1861 206 211 #	420 10	
TSH 158 /1					420GS	
				1863 600 123	GR-4	mit Anlauftring / with thrust ring (88)

Z...						
Z 200				1882 325 134	380	
ZA 200					G380	
ZA 200 /1-4						
ZAFD 200 /36						























RENAULT TRUCKS

B 01.83 - 09.95						
80	10.82 -			1850 280 790 #	235	Nur bei Altteil-Rückgabe lieferbar (Reparatur; Werk Bielefeld) / Please return old unit for repair (plant Bielefeld) (49)
				1878 001 713	235 10	
				3151 859 001	KZAS-0	
				1863 869 041		
110	10.92 - 01.96	Sofim8140.27		3499 373 055	250	Getr. / GBox: ZF
				1897 375 775	KZA-5	Getr. / GBox: ZF
				1863 869 041		















C 10.82 - 10.98						
C 210.19 C 210.19	12.83 - 05.91	MIDS06.20.30N		3482 037 141	380	
				1878 000 960	380 16	
				3151 000 285	KZI-4	
C 230ti.19	05.90 - 07.92	MIDR06.02.26D		3482 037 141	380	Getr. / GBox: G406/409
				1878 000 960	380 16	Getr. / GBox: G406/409
				3151 000 285	KZI-4	Getr. / GBox: G406/409
C 260.19 C 260.19 C 260.19,C 280.19 C 260.26 C 260.26	10.82 - 05.91 10.82 - 05.91 10.82 - 10.98 10.82 - 05.91 10.82 - 05.91	MIDS06.20.45B		1878 027 442	430 20	->04.1985 Getr. / GBox: RVI
				3482 097 141	430	->12.1985 Getr. / GBox: Fuller
				1878 022 841	430 10	->12.1985 Getr. / GBox: Fuller
				3400 116 801	430 20	05.1985-> Getr. / GBox: B9/B18
				3482 097 141	GMFZ430	
				1878 027 442	430GTZ	
				3100 008 106	430GTZ	
				3400 116 601 HD	KZISZ-5	05.1985-> Getr. / GBox: RVI
	3482 097 141	GMFZ430				
	1878 020 241	430WGTZ				
	3100 008 106	KZISZ-5				
	1882 022 101	420	Getr. / GBox: 5S-110 Nebenantriebs-ID / PTO ID: 110 (48)			
	1878 634 014	G420XN	Getr. / GBox: 5S-110 Nebenantriebs-ID / PTO ID: 110 (48)			
		420GSZ				

		CODE					
--	--	------	--	--	---	---	---

RENAULT TRUCKS















C 10.82 - 10.98										
C 280.19	07.92 - 03.93	MIDS06.20.45B	 3400 116 801 ⊗ 3482 097 141 ⊗ 1878 027 442 ⊙ 3100 008 106	430 20 GMFZ430 430GTZ KZISZ-5	->09.1992 Getr. / GBox: RVI					
			 3482 083 044	430 MFZ430	11.1992-> Getr. / GBox: B9					
			 1878 020 241	430 20 430WGTZ	11.1992-> Getr. / GBox: B9					
			 1878 027 442	430 20 430GTZ	11.1992-> Getr. / GBox: B9					
			 3100 008 106 ⊙ 3151 234 132 ⊙ 3180 000 009	KZISZ-5 KZISZ-5	11.1992-> Getr. / GBox: B9 Beinhaltet Ausrücker und Montagesatz / Contains releaser and fitting kit	(14)				
C 290.19,C 300.19 C 290.26,C 300.26	10.82 - 10.98	MIDR062045B	 3400 116 601 ⊗ 3482 097 141 ⊗ 1878 020 241 ⊙ 3100 008 106	430 20 GMFZ430 430WGTZ KZISZ-5	Getr. / GBox: B9/B18					
			 3482 097 141	430 GMFZ430	Getr. / GBox: Fuller RTO 9505					
			 3482 097 141	430 GMFZ430	Getr. / GBox: Fuller RTX 116.09					
			 1878 022 841	430 10 430GTZ	Getr. / GBox: Fuller					
			 3100 008 106 ⊙ 3151 234 132 ⊙ 3180 000 009	KZISZ-5 KZISZ-5	Getr. / GBox: Fuller RTX 116.09 Beinhaltet Ausrücker und Montagesatz / Contains releaser and fitting kit	(14)				
C 290.19/T C 290.19/T C 290.26,C 300.26	05.86 - 05.91	MIDR062045B	 3400 116 801 ⊗ 3482 097 141 ⊗ 1878 027 442 ⊙ 3100 008 106	430 20 GMFZ430 430GTZ KZISZ-5	Getr. / GBox: RVI					
			 3400 116 601 ⊗ 3482 097 141 ⊗ 1878 020 241 ⊙ 3100 008 106	430 20 GMFZ430 430WGTZ KZISZ-5	Getr. / GBox: B9/B18					
			 3400 700 336 ⊗ 3482 097 141 ⊗ 1878 022 841 ⊙ 3100 008 106	430 10 GMFZ430 430GTZ KZISZ-5	Getr. / GBox: Fuller					
C 300.19 C 300.19 C 300.19 C 300.24 C 300.24 C 300.26 CCH 300.26 CCH 300.26 CCH 300.30 CCH 300.30	04.87 - 10.98	MIDR062045D	 3400 116 601 ⊗ 3482 097 141 ⊗ 1878 020 241 ⊙ 3100 008 106	430 20 GMFZ430 430WGTZ KZISZ-5	->09.1992 Getr. / GBox: B9/B18					
			 3400 116 801 ● ⊗ 3482 097 141 ⊗ 1878 027 442 ⊙ 3100 008 106	430 20 GMFZ430 430GTZ KZISZ-5	->09.1992 Getr. / GBox: B9/B18					
			 3400 117 202 ⊗ 3482 083 044 ⊗ 1878 020 241 ⊙ 3100 008 106	430 20 MFZ430 430WGTZ KZISZ-5	10.1992-> Getr. / GBox: B9					
			 3400 117 201 ⊗ 3482 083 044 ⊗ 1878 020 241 ⊙ 3100 008 204	430 20 MFZ430 430WGTZ	10.1992-> Getr. / GBox: B9+35mm,B18					
			 3400 116 701 ⊗ 3482 097 141 ⊗ 1878 026 241 ⊙ 3100 008 106	430 10 GMFZ430 430WGTZ KZISZ-5	10.1992-> Getr. / GBox: ZF S6-90					
			 3400 116 901 ⊗ 3482 083 044 ⊗ 1878 026 241 ⊙ 3100 008 106	430 10 MFZ430 430WGTZ KZISZ-5	10.1992-> Getr. / GBox: ZF 9S-109					
			C 340.19/T C 340ti.17/T C 340ti.17/T C 340ti.19/T	07.90 - 10.98	MIDR062045E	 3400 116 601 ⊗ 3482 097 141 ⊗ 1878 020 241 ⊙ 3100 008 106	430 20 GMFZ430 430WGTZ KZISZ-5	->09.1992 Getr. / GBox: B9/B18		
						 3400 117 101 ⊗ 3482 123 243 ⊗ 1878 020 241 ⊙ 3100 008 204	430 20 MFZ430 430WGTZ	10.1992-> Getr. / GBox: B9+35mm,B18		
						 3400 123 101 # ⊗ 3482 123 243 ⊗ 1878 020 241 ⊙ 3100 008 106	430 20 MFZ430 430WGTZ KZISZ-5	10.1992-> Getr. / GBox: B9		



RENAULT TRUCKS

C-Serie		01.13 -						
380P	01.13-	DTI11		3400 700 600 ⊕ ⊗ 3483 000 348 ⊗ 1878 007 046	430 24 MFZ430	Getr. / GBox: MT 2214B / MT 2514B Getr. / GBox: MTO 2214B/MTO 2514B Abgasnorm: Euro 6 / Exhaust Emission Norm: Euro 6	(4)	
380P, 380PK	01.13-				3400 710 064 ⊗ 3482 001 169 ⊗ 1878 007 170 ⚡ 6482 000 155	430 24 MFZ430 430WGTZ PHIS-6/38	Getr. / GBox: AT 2412/E /AT 2612/E Getr. / GBox: ATO 2612/E Abgasnorm: Euro 6 / Exhaust Emission Norm: Euro 6	(4)
380P, 380PK	01.13-							
380P, 380PK, 380P XLOAD	01.13-							
380T, 380TK	01.13-							
380T, 380TK	01.13-							
430P	01.13-							
430P	01.13-							
430P, 430PK	01.13-							
430P, 430PK, 430P XLOAD	01.13-							
430T, 430TK	01.13-							
430T, 430TK	01.13-							
460P	01.13-							
460P, 460PK	01.13-							
460P, 460PK, 460P XLOAD	01.13-							
460T, 460TK	01.13-							
460T, 460TK	01.13-							
440P	01.13-	DTI13		3400 700 600 ⊕ ⊗ 3483 000 348 ⊗ 1878 007 046	430 24 MFZ430	Getr. / GBox: MT 2214B / MT 2514B Getr. / GBox: MTO 2214B/MTO 2514B Abgasnorm: Euro 6 / Exhaust Emission Norm: Euro 6	(4)	
440P, 440PK	01.13-				3400 710 064 ⊗ 3482 001 169 ⊗ 1878 007 170 ⚡ 6482 000 155	430 24 MFZ430 430WGTZ PHIS-6/38	Getr. / GBox: AT 2412/E /AT 2612/E Getr. / GBox: ATO 2612/E Abgasnorm: Euro 6 / Exhaust Emission Norm: Euro 6	(4)
440P, 440PK	01.13-							
440T, 440TK	01.13-							
440T, 440TK	01.13-							
480P	01.13-							
480P, 480PK	01.13-							
480P, 480PK	01.13-							
480P, 480PK	01.13-							
480T, 480TK	01.13-							
480T, 480TK	01.13-							
520P	01.13-		DTI13		3400 700 600 ⊕ ⊗ 3483 000 348 ⊗ 1878 007 046	430 24 MFZ430	Getr. / GBox: MTO 2514B Abgasnorm: Euro 6 / Exhaust Emission Norm: Euro 6	(4)
520P, 520PK	01.13-					3400 710 064 ⊗ 3482 001 169 ⊗ 1878 007 170 ⚡ 6482 000 155	430 24 MFZ430 430WGTZ PHIS-6/38	Getr. / GBox: AT2612/E / ATO2612/E Abgasnorm: Euro 6 / Exhaust Emission Norm: Euro 6
520P, 520PK	01.13-							
520P, 520PK	01.13-							
520T, 520TK	01.13-							
520T, 520TK	01.13-							
CBH								
CBH 280.26	04.86 - 10.92	MIDS063540		3482 097 141	430 GMFZ430	->05.1986 Getr. / GBox: Fuller RTO 9509		
CBH 280.26	04.86 - 10.92				1878 022 841	430 10 430GTZ	->05.1986 Getr. / GBox: Fuller RTO 9509	
CBH 280.26	04.86 - 10.92				3400 116 601 ⊗ 3482 097 141 ⊗ 1878 020 241 ⚡ 3100 008 106	430 20 GMFZ430 430WGTZ KZISZ-5	Getr. / GBox: RVI	
CBH 280.26/T	04.86 - 10.92				3400 123 201 ▲ ⊗ 3482 123 441 ⊗ 1878 022 841 ⚡ 3100 008 106	430 10 GMFZ430 430GTZ KZISZ-5	Getr. / GBox: Fuller RTX 113.09	
CBH 280.34	04.86 - 10.92		MIDR06.35.40M ³			3400 117 202 ⊗ 3482 083 044 ⊗ 1878 020 241 ⚡ 3100 008 106	430 20 MFZ430 430WGTZ KZISZ-5	Getr. / GBox: B9
CBH 280.34	04.86 - 10.92					3400 117 201 ⊗ 3482 083 044 ⊗ 1878 020 241 ⚡ 3100 008 204	430 20 MFZ430 430WGTZ	Getr. / GBox: B9+35mm,B18
CBH 280.34	04.86 - 10.92					3483 023 001 ⊕	445 GMFZ445W	für Fahrzeuge mit Wandlerschaltkupplung / for vehicles with converter and clutch unit
CBH 280.34/T	04.86 - 10.92					1878 051 801	445 24 445GTZC	für Fahrzeuge mit Wandlerschaltkupplung / for vehicles with converter and clutch unit

		CODE				
--	--	------	--	---	---	---















































RENAULT TRUCKS

CBH						
CBH 320.26	10.92 - 10.98	MIDR06.35.40M ³		3400 117 202 ⊗ 3482 083 044 ⊗ 1878 020 241 ⊙ 3100 008 106	430 20 MFZ430 430WGTZ KZISZ-5	Getr. / GBox: B9
CBH 320.26	10.92 - 10.98					
CBH 320.26	10.92 - 10.98					
CBH 320.26	10.92 - 10.98			3400 117 201 ⊗ 3482 083 044 ⊗ 1878 020 241 ⊙ 3100 008 204	430 20 MFZ430 430WGTZ	Getr. / GBox: B9+35mm,B18
CBH 320.26/T	10.92 - 10.98					
CBH 320.26/T	10.92 - 10.98					
CBH 340.26	02.88 - 10.92	MIDR063540		3400 116 601 ⊗ 3482 097 141 ⊗ 1878 020 241 ⊙ 3100 008 106	430 20 GMFZ430 430WGTZ KZISZ-5	Getr. / GBox: B9/B18 Getr. / GBox: RVI
				3400 117 001 ⊗ 3482 123 441 ⊗ 1878 020 241 ⊙ 3100 008 106	430 20 GMFZ430 430WGTZ KZISZ-5	für / for: TELMA Getr. / GBox: B9/B18
						(68)
CBH 340.26	02.88 - 10.92	MIDR063540		3400 116 601 ⊗ 3482 097 141 ⊗ 1878 020 241 ⊙ 3100 008 106	430 20 GMFZ430 430WGTZ KZISZ-5	Getr. / GBox: B9/B18 Getr. / GBox: RVI
				3400 117 001 ⊗ 3482 123 441 ⊗ 1878 020 241 ⊙ 3100 008 106	430 20 GMFZ430 430WGTZ KZISZ-5	für / for: Telma Getr. / GBox: B9/B18
						(68)
CBH 350.26	05.90 - 01.93	MIDR063540G		3400 116 601 ⊗ 3482 097 141 ⊗ 1878 020 241 ⊙ 3100 008 106	430 20 GMFZ430 430WGTZ KZISZ-5	->10.1992 Getr. / GBox: B9/B18
CBH 350.26	05.90 - 01.93					
CBH 350.26	05.90 - 01.93					
CBH 350.34	05.90 - 01.93			3400 117 001 HD ⊗ 3482 123 441 ⊗ 1878 020 241 ⊙ 3100 008 106	430 20 GMFZ430 430WGTZ KZISZ-5	->10.1992 Getr. / GBox: B9/B18
CBH 350.34	05.90 - 01.93					
CBH 380.26	01.90 - 10.92	MIDR063540		3400 117 001 ⊗ 3482 123 441 ⊗ 1878 020 241 ⊙ 3100 008 106	430 20 GMFZ430 430WGTZ KZISZ-5	Getr. / GBox: B9/B18
CBH 380.26	01.90 - 10.92					
CBH 380.34	01.90 - 10.92					
CBH 380.34	01.90 - 10.92					
CBH 385.24	10.92 - 10.98	MIDR06.35.40N/ ³		3400 117 001 ⊗ 3482 123 441 ⊗ 1878 020 241 ⊙ 3100 008 106	430 20 GMFZ430 430WGTZ KZISZ-5	->10.1992 Getr. / GBox: B9/B18
CBH 385.24	10.92 - 10.98					
CBH 385.24	10.92 - 10.98					
CBH 385.26	10.92 - 10.98			3400 093 031 ⊕ ⊗ 3488 017 334 ⊗ 1862 379 031	400 20 MFZ2/400X 400WGVZ	10.1992 - 10.1996
CBH 385.34	10.92 - 10.98			3483 023 001 ⊕	445 GMFZ445W	für Fahrzeuge mit Wandlerschaltkupplung / for vehicles with converter and clutch unit
CBH 385.34	10.92 - 10.98			1878 051 801	445 24 445GTZC	für Fahrzeuge mit Wandlerschaltkupplung / for vehicles with converter and clutch unit
CBH 385.34	10.92 - 10.98					(76)
CBH 385.34	10.92 - 10.98					(76)
CBH 385.34/T	10.92 - 10.98					
CBH 385.34/T	10.92 - 10.98					
CBH 385.24	10.92 - 10.98	MIDR06.35.40N/ ³		3400 117 001 ⊗ 3482 123 441 ⊗ 1878 020 241 ⊙ 3100 008 106	430 20 GMFZ430 430WGTZ KZISZ-5	->10.1992 Getr. / GBox: B9/B18
CBH 385.26	10.92 - 10.98					
CBH 385.26	10.92 - 10.98					
CBH 385.26	10.92 - 10.98			3400 093 031 ⊕ ⊗ 3488 017 334 ⊗ 1862 379 031	400 20 MFZ2/400X 400WGVZ	10.1992 - 10.1996
CBH 385.26/T	10.92 - 10.98					
CBH 385.26/T	10.92 - 10.98					

CLM						
CLM 280	11.92 -	MIDS063540		3400 116 601 ⊗ 3482 097 141 ⊗ 1878 020 241 ⊙ 3100 008 106	430 20 GMFZ430 430WGTZ KZISZ-5	Getr. / GBox: B9/B18
				3400 123 201 ▲ ⊗ 3482 123 441 ⊗ 1878 022 841 ⊙ 3100 008 106	430 10 GMFZ430 430GTZ KZISZ-5	Getr. / GBox: Eaton RTX 11609B





















		CODE					
--	--	------	--	--	---	---	---

RENAULT TRUCKS

CLM							
CLM 280.19/T	04.86 - 10.92	MIDS063540	 3482 097 141	430 GMFZ430	->07.1986 Getr. / GBox: Fuller RTO 9509		
			 1878 022 841	430 10 430GTZ	->07.1986 Getr. / GBox: Fuller RTO 9509		
			 3400 116 601  3482 097 141  1878 020 241  3100 008 106	430 20 GMFZ430 430WGTZ KZISZ-5	Getr. / GBox: B9/B18		
			 3400 123 201 ▲  3482 123 441  1878 022 841  3100 008 106	430 10 GMFZ430 430GTZ KZISZ-5	Getr. / GBox: Eaton RTX 11609 B		
CLM 320.19/T CLM 320.25/T	10.92 - 10.98 10.92 - 10.98	MIDR06.35.40M ³	 3400 117 202  3482 083 044  1878 020 241  3100 008 106	430 20 MFZ430 430WGTZ KZISZ-5	Getr. / GBox: B9		
			 3400 117 201  3482 083 044  1878 020 241  3100 008 204	430 20 MFZ430 430WGTZ	Getr. / GBox: B9+35mm,B18		
			 3483 023 001 ⊕	445 GMFZ445W	für Fahrzeuge mit Wandlerschaltkupplung / for vehicles with converter and clutch unit	(76)	
			 1878 051 801	445 24 445GTZC	für Fahrzeuge mit Wandlerschaltkupplung / for vehicles with converter and clutch unit	(76)	
CLM 340 T CLM 380.19/T	- 09.92 05.91 - 10.92	MIDR063540	 3400 117 001 HD  3482 123 441  1878 020 241  3100 008 106	430 20 GMFZ430 430WGTZ KZISZ-5	Getr. / GBox: B9/B18		
			 3400 116 601  3482 097 141  1878 020 241  3100 008 106	430 20 GMFZ430 430WGTZ KZISZ-5	Getr. / GBox: B9/B18		
CLM 350	- 09.92	MIDR063540	 3400 116 601  3482 097 141  1878 020 241  3100 008 106	430 20 GMFZ430 430WGTZ KZISZ-5	Getr. / GBox: B9/B18		
CLM 385.19/T CLM 385.22/T CLM 385.25/T	10.92 - 10.98 10.92 - 10.98 10.92 - 10.98	MIDR06.35.40N/ ³	 3400 093 031 ⊕  3488 017 334  1862 379 031	400 20 MFZ2/400X 400WGVZ	Getr. / GBox: B9/B18		
			 3483 023 001 ⊕	445 GMFZ445W	für Fahrzeuge mit Wandlerschaltkupplung / for vehicles with converter and clutch unit	(76)	
			 1878 051 801	445 24 445GTZC	für Fahrzeuge mit Wandlerschaltkupplung / for vehicles with converter and clutch unit	(76)	
CLR							
220		MIDS062030	 3482 037 141	380 GM380	Getr. / GBox: B6 Für Export / for export	(25)	
			 1864 523 441	380 16 380Z	Getr. / GBox: B6 Für Export / for export	(25)	
			 3151 000 285	KZI-4	Getr. / GBox: B6 Für Export / for export	(25)	
220 (11G.)		MIDS062030	 3482 037 141	380 GM380	Getr. / GBox: BD SL 132 + Relais Für Export / for export	(25)	
			 1864 523 441	380 16 380Z	Getr. / GBox: BD SL 132 + Relais Für Export / for export	(25)	
			 3151 000 285	KZI-4	Getr. / GBox: BD SL 132 + Relais Für Export / for export	(25)	
230 CLR 230.19	10.92 - 09.90 - 10.98	MIDR062226D	 3482 037 141	380 GM380	Getr. / GBox: G406/409		
			 3151 000 285	KZI-4	Getr. / GBox: G406/409		
F							
620			 1878 001 729	350 10 350GTD			















		CODE				
--	--	------	--	---	---	---

RENAULT TRUCKS

G 10.82 - 09.91						
G 170.11	05.83 - 02.90	MIDR06.02.12D		3482 124 041	350 MF350	Getr. / GBox: Fuller RTX 7609
G 170.13	05.83 - 02.90			3151 000 285	KZI-4	Getr. / GBox: Fuller RTX 7609
G 170.15	05.83 - 02.90			3482 124 041 	350 MF350	Getr. / GBox: RVI
G 170.16	05.83 - 02.90	MIDR060212		1878 002 075 # 	350 16 350GTZ	Getr. / GBox: RVI
G 170.17	05.83 - 02.90			3151 000 285 	KZI-4	Getr. / GBox: RVI
G 170.17	05.83 - 02.90					
G 200.13	05.90 - 09.91	MIDR060226H		3400 700 339  3482 124 041  1878 001 729  3151 270 341	350 10 MF350 350GTD KZIS-3	Getr. / GBox: ZF S6-36S
G 200.15	05.90 - 09.91					
G 200.16	05.90 - 09.91					
G 200.16	05.90 - 09.91					
G 200.17	05.90 - 09.91					
G 200.18	05.90 - 09.91					
G 210.16	11.83 - 02.90	MIDS06.20.30N 1, MIDS06.20.30N		3482 037 141	380 GM380	Getr. / GBox: G406/409
				1864 523 441	380 16 380Z	Getr. / GBox: G406/409
G 210.17 BOM	11.83 - 02.90	MIDS062030		1864 497 043	430 16 430Z	Getr. / GBox: B6 Getr. / GBox: G406/409
G 210.17 BOM	11.83 - 02.90					
G 210.18 BOM	11.83 - 02.90			1897 376 506	KZA-4,5	Getr. / GBox: B6 Getr. / GBox: G406/409
G 210.19 BOM	11.83 - 02.90					
G 210.19	11.83 - 02.90	MIDSO62030		3482 037 141	380 GM380	Getr. / GBox: RVI
				1864 523 441	380 16 380Z	Getr. / GBox: RVI
				3151 000 285	KZI-4	Getr. / GBox: RVI
G 230.11	01.85 - 05.90	MIDO62030		3482 037 141	380 GM380	
G 230.13	01.85 - 05.90					
G 230.13 SP	01.85 - 08.91					
G 230.15	01.85 - 05.90					
G 230.15/T	01.85 - 05.90					
G 230.16	01.85 - 05.90					
G 230.16	01.85 - 05.90					
G 230.17	01.85 - 05.90					
G 230.17	01.85 - 05.90					
G 230.17	01.85 - 05.90					
G 230.17/T	01.85 - 05.90					
G 230.19	01.85 - 05.90					
G 230.19	01.85 - 05.90					
G 230ti.13	02.90 - 08.91	MIDR06.02.26D		3482 037 141	380 GM380	Getr. / GBox: G406/409
G 230ti.15	02.90 - 08.91	MIDR06.02.26D		3482 037 141	380 GM380	Getr. / GBox: G406/409
G 230ti.16	02.90 - 08.91			3151 000 285	KZI-4	Getr. / GBox: G406/409
G 230ti.16	02.90 - 08.91					
G 230ti.17	02.90 - 08.91					
G 230ti.18	02.90 - 08.91					
G 230ti.18	02.90 - 08.91					
G 230ti.19	02.90 - 08.91					
G 230ti.19	02.90 - 08.91					





		CODE				
--	--	------	--	---	---	---









RENAULT TRUCKS









G 10.82 - 09.91						
G 260.15/T	10.82 - 05.90	MIDSO62045		3400 116 801 ⊗ 3482 097 141 ⊗ 1878 027 442 ⬤ 3100 008 106	430 20 GMFZ430 430GTZ KZISZ-5	04.1985-> Getr. / GBox: RVI
G 260.16	10.82 - 05.90					
G 260.16	10.82 - 05.90					
G 260.17	10.82 - 05.90			3482 097 141	430 GMFZ430	->05.1985 Getr. / GBox: Fuller
G 260.17	10.82 - 05.90					
G 260.17	10.82 - 05.90			1878 022 841	430 10 430GTZ	->05.1985 Getr. / GBox: Fuller
G 260.17/T	10.82 - 05.90					
G 260.19	10.82 - 05.90					
G 260.19	10.82 - 05.90					
G 260.19	10.82 - 05.90					
G 260.19/T	10.82 - 05.90					
G 260.22/T	10.82 - 05.90					
G 260.24 CIT	10.82 - 05.90					
G 260.17	01.90 - 09.91	MIDSO62045		3400 116 801 ⊗ 3482 097 141 ⊗ 1878 027 442 ⬤ 3100 008 106	430 20 GMFZ430 430GTZ KZISZ-5	Getr. / GBox: RVI
G 280.13	01.90 - 09.91	MIDSO62045B		3400 116 801 ⊗ 3482 097 141 ⊗ 1878 027 442 ⬤ 3100 008 106	430 20 GMFZ430 430GTZ KZISZ-5	Getr. / GBox: RVI
G 280.15	01.90 - 09.91					
G 280.15/T	01.90 - 09.91					
G 280.16	01.90 - 09.91			1882 022 101	420 G420XN	Getr. / GBox: 16S-130 Nebenantriebs-ID / PTO ID: 130 (48)
G 280.16	01.90 - 09.91					
G 280.18	01.90 - 09.91			1878 003 276	420 10 420GTZ	Getr. / GBox: 16S-130 Nebenantriebs-ID / PTO ID: 130 (48)
G 280.19	01.90 - 09.91					
G 280.19	01.90 - 09.91			3151 204 001	KZI-6	Getr. / GBox: 16S-130 mit Schmierrohranschluß / with lubricating pipe coupling Nebenantriebs-ID / PTO ID: 130 (91)
G 280.24	01.90 - 09.91					
G 280.26	01.90 - 09.91					
G 290.17/TD	11.85 - 12.89	MIDR062045		3400 116 601 ⊗ 3482 097 141 ⊗ 1878 020 241 ⬤ 3100 008 106	430 20 GMFZ430 430WGTZ KZISZ-5	Getr. / GBox: B9/B18
G 290.19	11.85 - 12.89					
G 290.19	11.85 - 12.89					
G 290.19	11.85 - 12.89			3400 700 336 ⊗ 3482 097 141 ⊗ 1878 022 841 ⬤ 3100 008 106	430 10 GMFZ430 430GTZ KZISZ-5	Getr. / GBox: Eaton
G 290.19/T	11.85 - 12.89					
G 290.22/TD	11.85 - 12.89					
G 290.24	11.85 - 12.89					
G 290.24 CIT	11.85 - 12.89					
G 290.24 CIT	11.85 - 12.89					
G 290.26	11.85 - 12.89					
G 290.26	11.85 - 12.89					
G 300.13	01.90 - 08.91	MIDR06.20.45D		3400 116 801 ⊗ 3482 097 141 ⊗ 1878 027 442 ⬤ 3100 008 106	430 20 GMFZ430 430GTZ KZISZ-5	Getr. / GBox: B9/B18
G 300.15	01.90 - 08.91					
G 300.15/T	01.90 - 08.91					
G 300.16	01.90 - 08.91			3400 123 201 ▲ ⊗ 3482 123 441 ⊗ 1878 022 841 ⬤ 3100 008 106	430 10 GMFZ430 430GTZ KZISZ-5	Getr. / GBox: ZF 16S-130 Getr. / GBox: Eaton RTXF 116
G 300.16	01.90 - 08.91					
G 300.17	01.90 - 08.91					
G 300.19	01.90 - 08.91			1882 022 101	420 G420XN	Getr. / GBox: 16S-130+ Nebenantriebs-ID / PTO ID: 130 (48)
G 300.19	01.90 - 08.91					
G 300.19/T	01.90 - 08.91			1878 003 276	420 10 420GTZ	Getr. / GBox: 16S-130+ Nebenantriebs-ID / PTO ID: 130 (48)
G 300.19/T	01.90 - 08.91					
G 300.24	01.90 - 08.91			3151 204 001	KZI-6	Getr. / GBox: 16S-130+ mit Schmierrohranschluß / with lubricating pipe coupling Nebenantriebs-ID / PTO ID: 130 (91)
G 300.24	01.90 - 08.91					
G 300.24	01.90 - 08.91					
G 300.25	01.90 - 08.91					
G 300.25	01.90 - 08.91					
G 300.26	01.90 - 08.91					
G 300.26	01.90 - 08.91					
G 300.26	01.90 - 08.91					
G 300.26 CIT	01.90 - 08.91					
G 300.26/T	01.90 - 08.91					

		CODE				
--	--	------	--	---	---	---

RENAULT TRUCKS







G 10.82 - 09.91						
G 320.19	11.88 - 05.90	MIDR06.20.45H		3400 116 601 ⊗ 3482 097 141 ⊗ 1878 020 241 ⊙ 3100 008 106	430 20 GMFZ430 430WGTZ KZISZ-5	Getr. / GBox: B9/B18
G 320.19 T	11.88 - 05.90					
G 320.24	11.88 - 05.90					
G 330.13	02.90 - 08.91	MIDR06.20.45H		3400 123 201 ▲ ⊗ 3482 123 441 ⊗ 1878 022 841 ⊙ 3100 008 106	430 10 GMFZ430 430GTZ KZISZ-5	Getr. / GBox: Eaton RTXF 116
G 330.15	02.90 - 08.91					
G 330.16	02.90 - 08.91					
G 330.16	02.90 - 08.91			3400 116 601 ⊗ 3482 097 141 ⊗ 1878 020 241 ⊙ 3100 008 106	430 20 GMFZ430 430WGTZ KZISZ-5	Getr. / GBox: B9/B18
G 330.17	02.90 - 08.91					
G 330.17/T	02.90 - 08.91					
G 330.19	02.90 - 08.91					
G 330.19	02.90 - 08.91					
G 330.19	02.90 - 08.91					
G 330.24	02.90 - 08.91					
G 330.26	02.90 - 08.91					
G 330.26	02.90 - 08.91					
G 340ti.19/T, G 330.19/T, G 330.17/T	01.90 - 08.91	MIDR06.20.45H, MIDR06.20.45E		3400 123 201 ▲ ⊗ 3482 123 441 ⊗ 1878 022 841 ⊙ 3100 008 106	430 10 GMFZ430 430GTZ KZISZ-5	Getr. / GBox: ZF 16S-130
G 340ti.19/T, G 330.19/T	02.90 - 08.91	3		3400 116 601 ⊗ 3482 097 141 ⊗ 1878 020 241 ⊙ 3100 008 106	430 20 GMFZ430 430WGTZ KZISZ-5	Getr. / GBox: RVI













GB						
131	10.78 -	797		3400 700 339 ⊗ 3482 124 041 ⊗ 1878 001 729 ⊙ 3151 270 341	350 10 MF350 350GTD KZIS-3	Getr. / GBox: ZFS5-35
191 , A	10.78 - 10.81	MIDO62030		3482 037 141	380 GM380	Getr. / GBox: 6G.
				1864 523 441	380 16 380Z	Getr. / GBox: 6G.
191 , A	11.81 -	MIDO62030		3482 037 141	380 GM380	Getr. / GBox: 6G.
				1864 523 441	380 16 380Z	Getr. / GBox: 6G.
				3151 000 285	KZI-4	Getr. / GBox: 6G.
231 , A, B	10.78 - 10.81	MIDSO62030		1864 497 043	430 16 430Z	
231 , A, B	11.81 -	MIDSO62030		1864 497 043	430 16 430Z	
				1897 376 506	KZA-4,5	





















GC						
190	01.75 - 12.79	MIDO62030		3482 037 141	380 GM380	Getr. / GBox: 10G.
				1864 523 441	380 16 380Z	Getr. / GBox: 10G.
191	10.78 - 10.81	MIDO62030		3482 037 141 ⊗	380 GM380	
191 , BOM	10.79 - 10.81			1864 523 441 ⊗	380 16 380Z	
191	11.81 -	MIDO62030		3482 037 141 ⊗	380 GM380	
				1864 523 441 ⊗	380 16 380Z	
				3151 000 285 ⊗	KZI-4	
191 , BOM	11.81 -	MIDO62030		3482 037 141	380 GM380	Getr. / GBox: 6G.
				1864 523 441	380 16 380Z	Getr. / GBox: 6G.
				3151 000 285	KZI-4	Getr. / GBox: 6G.







		CODE				
--	--	------	--	---	---	---

RENAULT TRUCKS

GC						
230 , A	01.75 - 12.79	MIDO62030		1864 497 043 	430 16	
231 , A	10.78 - 10.81				430Z	
231 , A	11.81 -	MIDO62030		1864 497 043 	430 16	
					430Z	
				1897 376 506 	KZA-4,5	







GF						
190 , A	01.75 - 12.79	MID062030		3482 037 141	380	Getr. / GBox: 6G.
191	01.75 - 12.79				GM380	
				1864 523 441	380 16	Getr. / GBox: 6G.
					380Z	
191 (6G.)	11.81 -	MID062030		3482 037 141	380	Getr. / GBox: BD SL021
					GM380	
				1864 523 441	380 16	Getr. / GBox: BD SL021
					380Z	
				3151 000 285	KZI-4	Getr. / GBox: BD SL021
230 , A	01.75 - 12.79	MID062030		1864 497 043	430 16	
					430Z	
231 , A	10.78 - 10.81	MID062030		1864 497 043 	430 16	
					430Z	
231 , A	11.81 -	MID062030		1864 497 043 	430 16	
					430Z	
				1897 376 506 	KZA-4,5	

GL						
GL 900 E (5G.)	06.75 - 12.79	MID042030		1878 001 729	350 10	Getr. / GBox: ZF
					350GTD	
				1864 454 101	350 10	Getr. / GBox: ZF
					350B	
GLM 280	04.86 -	MIDS063540		3400 700 336	430 10	Getr. / GBox: Fuller RTO 9509
				 3482 097 141	GMFZ430	
				 1878 022 841	430GTZ	
				 3100 008 106	KZISZ-5	
GLM 280		MIDS063540		3482 097 141	430	->03.1986
					GMFZ430	Getr. / GBox: Fuller RTO 9509
				1878 022 841	430 10	->03.1986
					430GTZ	Getr. / GBox: Fuller RTO 9509
						Beinhaltet Ausrücker und Montagesatz / Contains releaser and fitting kit (14)
				3482 097 141	430	04.1986->
					GMFZ430	Getr. / GBox: RVI
						Getr. / GBox: Fuller RTO 9505
				1878 027 442	430 20	04.1986->
					430GTZ	Getr. / GBox: RVI
						Getr. / GBox: Fuller RTO 9505
				3100 008 106	KZISZ-5	04.1986->
				 3151 234 132	KZISZ-5	Getr. / GBox: RVI
				 3180 000 009		Getr. / GBox: Fuller RTO 9505
						Beinhaltet Ausrücker und Montagesatz / Contains releaser and fitting kit (14)
GLR 190 , A	10.78 -	MID062030		3482 037 141 	380	
					GM380	
				1864 523 441 	380 16	
					380Z	
				3151 000 285 	KZI-4	11.1981->
GLR 200	01.70 - 12.80	MID062040		1864 523 441	380 16	
					380Z	
GLR 230	10.78 -	MIDS062030		1864 497 043	430 16	
					430Z	
				1897 376 506	KZA-4,5	11.1981->

GR						
191 , A, B	10.78 -	MIDO62030		3482 037 141 	380	
					GM380	
				1864 523 441 	380 16	
					380Z	
				3151 000 285 	KZI-4	11.1981->



















		CODE					
--	--	------	--	--	---	---	---

RENAULT TRUCKS

GR							
230 , A	10.77 - 12.79	MIDSO62030		1864 497 043	430 16 430Z	Getr. / GBox: BDSL	
231 , A	10.78 -	MIDSO62030		1864 497 043 	430 16 430Z	Getr. / GBox: BDSL	
				1897 376 506 	KZA-4,5	11.1981-> Getr. / GBox: BDSL	
231 , A (6G.)	01.81 -	MIDSO62030		1864 497 043	430 16 430Z	Getr. / GBox: BDSL	
				1897 376 506	KZA-4,5	Getr. / GBox: BDSL	
260	02.72 - 12.74	MIDSO62030		1864 497 042	430 20 430Z	Getr. / GBox: BM 8.120	
280 , A, B	01.73 - 12.82			1878 027 442	430 20 430GTZ		
		MIDSO62030		1864 497 042	430 20 430Z	Getr. / GBox: BM 8.120	
305 , A, B	01.77 - 12.80			1864 497 042	430 20 430Z	Getr. / GBox: BM 8.120	
320 , B	01.74 - 12.78			1864 497 042	430 20 430Z		







GRH							
235 R 6x4 305 6x4	10.78 -			1864 497 042	430 20 430Z	Getr. / GBox: BM8.120	
	10.77 - 12.80			1878 027 442	430 20 430GTZ	Getr. / GBox: B9.150	

H							
HB 15, 17, 19, 26	01.78 - 12.80			3482 002 234	350 GMF350X		
				3151 000 395	KZIS-4		
HM 15, 17, 19, 26	01.78 - 12.80	MAN2566		3482 002 234	350 GMF350X		
				3151 000 395	KZIS-4		

J							
JK 60, 65, 75, 85 JN 85 BOM (5G.) JN 85 Tankwagen / road tanker (5G.)	-04.86	720		3499 373 055	250 MF250	Getr. / GBox: ZFS5-24	
	06.79 -			1897 375 775	KZA-5	Getr. / GBox: ZFS5-24	
JK 60, 85	-04.86			3499 373 055	250 MF250	Getr. / GBox: 321	
				1862 353 041 ▲	250 10 250CB	Getr. / GBox: 321	
JK 75 Müllwagen / refuse collecting vehicle				3499 373 055	250 MF250	Getr. / GBox: ZFS5-24	
				1897 375 775	KZA-5	Getr. / GBox: ZFS5-24	
JN 60, 75, 80 (5G.) JN 90 (5G.) JP 11, 13, 14 (5G.)	01.78 - 12.83	797		3400 117 301 #	310 10 MF310 310GTD	Getr. / GBox: ZFS5-35	
	01.76 - 12.83			 3482 008 033  1861 577 037  3151 199 001	KZIS-3		
JP 13 JR 19 JR 21	01.76 - 12.83	798		3400 700 339	350 10 MF350 350GTD	Getr. / GBox: ZF	
	-12.76			 3482 124 041  1878 001 729  3151 270 341	KZIS-3		
JP 13 A (12G.)	01.76 - 12.83	797		3482 124 041	350 MF350	Getr. / GBox: ZFS6-65+GV80	
				1864 351 005 ▲	350 10 350Z	Getr. / GBox: ZFS6-65+GV80	
JR 19 JX 21	01.76 - 01.79 -	798		3482 124 041	350 MF350	Getr. / GBox: ZF	
				1864 351 005 ▲	350 10 350Z	Getr. / GBox: ZF	

























































		CODE				
--	--	------	--	---	---	---

RENAULT TRUCKS

K-Serie		01.13 -				
380P MEDIUM, 380P HEAVY	01.13-	DTI11	 3400 700 600 ⊕ ⊗ 3483 000 348 ⊗ 1878 007 046	430 24 MFZ430	Getr. / GBox: MT 2214B / MT 2514B Getr. / GBox: MTO 2214B/MTO 2514B Abgasnorm: Euro 6 / Exhaust Emission Norm: Euro 6	(4)
380P MEDIUM, 380P HEAVY	01.13-		 3400 710 064 ⊗ 3482 001 169 ⊗ 1878 007 170 ⚡ 6482 000 155	430 24 MFZ430 430WGTZ PHIS-6/38	Getr. / GBox: AT 2412/E / AT 2612/E Getr. / GBox: ATO 2612/E Abgasnorm: Euro 6 / Exhaust Emission Norm: Euro 6	(4)
380P MEDIUM, 380P HEAVY	01.13-					
380P MEDIUM, 380P HEAVY	01.13-					
380P MEDIUM, 380P HEAVY, 380P XTREM	01.13-					
380T MEDIUM, 380T HEAVY	01.13-					
380T MEDIUM, 380T HEAVY	01.13-					
380T MEDIUM, 380T HEAVY	01.13-					
430P MEDIUM, 430P HEAVY	01.13-					
430P MEDIUM, 430P HEAVY	01.13-					
430P MEDIUM, 430P HEAVY	01.13-					
430P MEDIUM, 430P HEAVY	01.13-					
430P MEDIUM, 430P HEAVY, 430P XTREM	01.13-					
430T MEDIUM, 430T HEAVY	01.13-					
430T MEDIUM, 430T HEAVY	01.13-					
430T MEDIUM, 430T HEAVY	01.13-					
460P MEDIUM, 460P HEAVY	01.13-					
460P MEDIUM, 460P HEAVY	01.13-					
460P MEDIUM, 460P HEAVY	01.13-					
460P MEDIUM, 460P HEAVY	01.13-					
460P MEDIUM, 460P HEAVY, 480P XTREM	01.13-					
460T MEDIUM, 460T HEAVY	01.13-					
460T MEDIUM, 460T HEAVY	01.13-					
460T MEDIUM, 460T HEAVY	01.13-					
440P MEDIUM, 440P HEAVY	01.13-	DTI13	 3400 700 600 ⊕ ⊗ 3483 000 348 ⊗ 1878 007 046	430 24 MFZ430	Getr. / GBox: MT 2214B / MT 2514B Getr. / GBox: MTO 2214B/MTO 2514B Abgasnorm: Euro 6 / Exhaust Emission Norm: Euro 6	(4)
440P MEDIUM, 440P HEAVY	01.13-		 3400 710 064 ⊗ 3482 001 169 ⊗ 1878 007 170 ⚡ 6482 000 155	430 24 MFZ430 430WGTZ PHIS-6/38	Getr. / GBox: AT 2412/E / AT 2612/E Getr. / GBox: ATO 2612/E Abgasnorm: Euro 6 / Exhaust Emission Norm: Euro 6	(4)
440P MEDIUM, 440P HEAVY	01.13-					
440P MEDIUM, 440P HEAVY	01.13-					
440P MEDIUM, 440P HEAVY, 440P XTREM	01.13-					
440T MEDIUM, 440T HEAVY	01.13-					
440T MEDIUM, 440T HEAVY	01.13-					
440T MEDIUM, 440T HEAVY	01.13-					
480P MEDIUM, 480P HEAVY	01.13-					
480P MEDIUM, 480P HEAVY	01.13-					
480P MEDIUM, 480P HEAVY	01.13-					
480P MEDIUM, 480P HEAVY	01.13-					
480P MEDIUM, 480P HEAVY, 480P XTREM	01.13-					
480T MEDIUM, 480T HEAVY	01.13-					
480T MEDIUM, 480T HEAVY	01.13-					
480T MEDIUM, 480T HEAVY	01.13-					
520P MEDIUM, 520P HEAVY	01.13-	DTI13	 3400 700 600 ⊕ ⊗ 3483 000 348 ⊗ 1878 007 046	430 24 MFZ430	Getr. / GBox: MTO 2514B Abgasnorm: Euro 6 / Exhaust Emission Norm: Euro 6	(4)
520P MEDIUM, 520P HEAVY, 520P XTREM	01.13-		 3400 710 064 ⊗ 3482 001 169 ⊗ 1878 007 170 ⚡ 6482 000 155	430 24 MFZ430 430WGTZ PHIS-6/38	Getr. / GBox: AT2612/E / ATO2612/E Abgasnorm: Euro 6 / Exhaust Emission Norm: Euro 6	(4)
520T MEDIUM, 520T HEAVY	01.13-					
520T MEDIUM, 520T HEAVY	01.13-					













		CODE				
--	--	------	--	---	---	---

RENAULT TRUCKS



















Kerax		06.97 -					
260.18 260.18/B 300.18/B 300.26/A,300.26/B 300.26/A,300.26/B 300.26/B	06.97 -	MIDR06.20.45D/41, MIDR06.20.45C/4	 3400 700 335 ▲  3482 083 252  1878 026 241  3151 278 941	430 10 MFZ430 430WGTZ KZIS-5	->12.1999 Getr. / GBox: ZF 9S-109		
	06.97 -		 3400 700 333  3482 083 252  1878 004 832  3151 278 941	430 10 MFZ430 430WGTZ KZIS-5	->12.1999 Getr. / GBox: ZF 16S-151		
	06.97 -		 3400 700 409  3482 083 252  1878 026 241  3151 250 231	430 10 MFZ430 430WGTZ KZISZ-5	01.2000-> Getr. / GBox: ZF 9S-109		
	06.97 -		 3400 700 334  3482 083 252  1878 004 832  3151 274 131	430 10 MFZ430 430WGTZ KZISZ-5	01.2000-> Getr. / GBox: ZF 16S-151		
	06.97 -		 3400 700 335 ▲  3482 083 252  1878 026 241  3151 278 941	430 10 MFZ430 430WGTZ KZIS-5	Getr. / GBox: ZF 8S-151		
			 3400 700 409  3482 083 252  1878 026 241  3151 250 231	430 10 MFZ430 430WGTZ KZISZ-5	Getr. / GBox: Eaton 8209A		
			 3400 700 311  3488 017 439  1862 379 032  3151 262 031	400 10 MFZ2/400X 400WGTZ KZISZ-5	Getr. / GBox: ZF 16S-151 Getr. / GBox: ZF 8S-151 für Fahrzeuge mit Zweis Scheibenkupplung / for vehicles with double disc clutch	(77)	
			 3400 700 485 #  3482 123 631  1878 004 832  3151 263 031	430 10 GMFZ430N 430WGTZ KZIZ-6	Getr. / GBox: ZF 16S-151 für Nebenantrieb / for PTO	(82)	
			 3400 700 409  3482 083 252  1878 026 241  3151 250 231	430 10 MFZ430 430WGTZ KZISZ-5	Getr. / GBox: ZF 9S-109 Getr. / GBox: Eaton 8309/A		
270.18 270.18	01.01 -	dCi11-270	 3400 700 311  3488 017 439  1862 379 032  3151 262 031	400 10 MFZ2/400X 400WGTZ KZISZ-5	für Fahrzeuge mit Zweis Scheibenkupplung / for vehicles with double disc clutch	(77)	
	01.01 -		 3400 700 485 #  3482 123 631  1878 004 832  3151 263 031	430 10 GMFZ430N 430WGTZ KZIZ-6	Getr. / GBox: ZF 16S-151 Nebenantriebs-ID / PTO ID: 221	(48)	
			 3400 700 334  3482 083 252  1878 004 832  3151 274 131	430 10 MFZ430 430WGTZ KZISZ-5	Getr. / GBox: ZF 8S-151 Getr. / GBox: ZF 16S-151		
320.18 320.18 320.26 320.26 320.26	01.01 -	dCi11G	 3400 700 311  3488 017 439  1862 379 032  3151 262 031	400 10 MFZ2/400X 400WGTZ KZISZ-5	für Fahrzeuge mit Zweis Scheibenkupplung / for vehicles with double disc clutch	(77)	
	01.01 -		 3400 700 485 #  3482 123 631  1878 004 832  3151 263 031	430 10 GMFZ430N 430WGTZ KZIZ-6	Getr. / GBox: ZF 16S-151 Nebenantriebs-ID / PTO ID: 221	(48)	
	01.01 -						

		CODE				
--	--	------	--	---	---	---

RENAULT TRUCKS















Kerax		06.97 -					
340.18	06.97 -	MIDR06.20.45E/41		3400 123 401 ⊗ 3482 083 252 ⊗ 1878 020 241 ⊙ 3151 250 231	430 20 MFZ430 430WGTZ KZISZ-5	Getr. / GBox: B9	
340.18/B	06.97 -			3400 700 408 ⊗ 3482 083 252 ⊗ 1878 020 241 ⊙ 3151 000 404	430 20 MFZ430 430WGTZ KZISZ-5	Getr. / GBox: B9+35mm,B18	
340.26/A,340.26/B	06.97 -			3400 117 532 ● ⊗ 3488 017 439 ⊗ 1862 379 031 ⊙ 3151 250 231	400 20 MFZ2/400X 400WGVZ KZISZ-5	Getr. / GBox: B9+35mm,B18 für Fahrzeuge mit Zweischeibenkupplung / for vehicles with double disc clutch	(77)
340.26/A,340.26/B	06.97 -			3400 700 333 ⊗ 3482 083 252 ⊗ 1878 004 832 ⊙ 3151 278 941	430 10 MFZ430 430WGTZ KZIS-5	Getr. / GBox: ZF 8S-151	
340.26/B	06.97 -			3482 083 252	430 MFZ430	->05.2001 Getr. / GBox: ZF 16S-151 bis Produktionsnummer / to production Number: CAM 16E1	(63)
340.32/A	06.97 -			1878 022 841	430 10 430GTZ	->05.2001 Getr. / GBox: ZF 16S-151 bis Produktionsnummer / to production Number: CAM 16E1	(63)
340.32/A	06.97 -			3151 278 941	KZIS-5	->05.2001 Getr. / GBox: ZF 16S-151 bis Produktionsnummer / to production Number: CAM 16E1	(63)
				3400 700 410 ⊗ 3482 083 252 ⊗ 1878 022 841 ⊙ 3151 274 131	430 10 MFZ430 430GTZ KZISZ-5	05.2001-> Getr. / GBox: ZF 16S-151 ab Produktionsnummer / from Production Number: CAM 17E1	(60)
				3400 700 340 ● ⊗ 3488 017 439 ⊗ 1862 379 032 ⊙ 3151 250 231	400 10 MFZ2/400X 400WGTZ KZISZ-5	->12.1999 Getr. / GBox: ZF 16S-151 für Fahrzeuge mit Zweischeibenkupplung / for vehicles with double disc clutch	(77)
				3400 700 311 ⊗ 3488 017 439 ⊗ 1862 379 032 ⊙ 3151 262 031	400 10 MFZ2/400X 400WGTZ KZISZ-5	01.2000-> Getr. / GBox: ZF 16S-221 Getr. / GBox: ZF 8S-151 Getr. / GBox: ZF 16S-151 für Fahrzeuge mit Zweischeibenkupplung / for vehicles with double disc clutch	(77)
				3400 700 485 # ⊗ 3482 123 631 ⊗ 1878 004 832 ⊙ 3151 263 031	430 10 GMFZ430N 430WGTZ KZIS-6	Getr. / GBox: ZF 16S-151 Nebenantriebs-ID / PTO ID: NMV 221	(48)
				3400 700 409 ⊗ 3482 083 252 ⊗ 1878 026 241 ⊙ 3151 250 231	430 10 MFZ430 430WGTZ KZISZ-5	Getr. / GBox: Eaton 8209 A	

RENAULT TRUCKS





















Kerax		06.97 -					
340.26	06.97 - 01.01	MIDR06.20.45E/41	 3400 123 401 ⊗ 3482 083 252 ⊗ 1878 020 241 ⊙ 3151 250 231	430 20 MFZ430 430WGTZ KZISZ-5	Getr. / GBox: B9		
			 3400 700 408 ⊗ 3482 083 252 ⊗ 1878 020 241 ⊙ 3151 000 404	430 20 MFZ430 430WGTZ KZISZ-5	Getr. / GBox: B9+35mm,B18		
			 3400 117 532 ● ⊗ 3488 017 439 ⊗ 1862 379 031 ⊙ 3151 250 231	400 20 MFZ2/400X 400WGVZ KZISZ-5	Getr. / GBox: B9+35mm,B18 für Fahrzeuge mit Zweischeibenkupplung / for vehicles with double disc clutch	(77)	
			 3400 700 333 ⊗ 3482 083 252 ⊗ 1878 004 832 ⊙ 3151 278 941	430 10 MFZ430 430WGTZ KZIS-5	Getr. / GBox: ZF 8S-151		
			 3482 083 252	430 MFZ430	Getr. / GBox: ZF 16S-151 bis Produktionsnummer / to production Number: CAM 16E1	(63)	
			 1878 022 841	430 10 430GTZ	Getr. / GBox: ZF 16S-151 bis Produktionsnummer / to production Number: CAM 16E1	(63)	
			 3151 278 941	KZIS-5	Getr. / GBox: ZF 16S-151 bis Produktionsnummer / to production Number: CAM 16E1	(63)	
			 3400 700 340 ● ⊗ 3488 017 439 ⊗ 1862 379 032 ⊙ 3151 250 231	400 10 MFZ2/400X 400WGTZ KZISZ-5	->12.1999 Getr. / GBox: ZF 16S-151 für Fahrzeuge mit Zweischeibenkupplung / for vehicles with double disc clutch	(77)	
			 3400 700 311 ⊗ 3488 017 439 ⊗ 1862 379 032 ⊙ 3151 262 031	400 10 MFZ2/400X 400WGTZ KZISZ-5	01.2000-> Getr. / GBox: ZF 16S-151 Getr. / GBox: ZF 16S-221 Getr. / GBox: ZF 8S-151 für Fahrzeuge mit Zweischeibenkupplung / for vehicles with double disc clutch	(77)	
			 3400 700 485 # ⊗ 3482 123 631 ⊗ 1878 004 832 ⊙ 3151 263 031	430 10 GMFZ430N 430WGTZ KZIZ-6	Getr. / GBox: ZF 16S-151 Nebenantriebs-ID / PTO ID: NMV 221	(48)	
			 3400 700 409 ⊗ 3482 083 252 ⊗ 1878 026 241 ⊙ 3151 250 231	430 10 MFZ430 430WGTZ KZISZ-5	Getr. / GBox: Eaton 8209 A		
350.34	01.03-	MIDR06.23.56A/3	 3400 700 334 ⊗ 3482 083 252 ⊗ 1878 004 832 ⊙ 3151 274 131	430 10 MFZ430 430WGTZ KZISZ-5	Getr. / GBox: ZF 16S-151		
			 3400 700 485 # ⊗ 3482 123 631 ⊗ 1878 004 832 ⊙ 3151 263 031	430 10 GMFZ430N 430WGTZ KZIZ-6	Getr. / GBox: ZF 16S-151 Nebenantriebs-ID / PTO ID: 221	(48)	
370		DXi11	 3400 700 399 ⊗ 3482 083 034 ⊗ 1878 004 832 ⊙ 3151 274 131	430 10 MFZ430 430WGTZ KZISZ-5	Getr. / GBox: 16S1620TD/1820TO Getr. / GBox: 1920TD/2220TO/2220TD		
			 3400 710 060 ⊗ 3482 000 552 ⊗ 1878 003 867 ⊙ 6482 000 155	430 24 MF430 430WGTZ PHIS-6/38	Getr. / GBox: AT2412C/ATO2512C		
370.18	01.01-	dCi11E	 3400 700 409 ⊗ 3482 083 252 ⊗ 1878 026 241 ⊙ 3151 250 231	430 10 MFZ430 430WGTZ KZISZ-5	Getr. / GBox: ZF 9S-109		
370.18	01.01-		 3482 083 252	430 MFZ430	Getr. / GBox: ZF 16S-221 Getr. / GBox: ZF 8S-151 Getr. / GBox: ZF 16S-151		
370.26	01.01-		 3151 274 131	KZISZ-5	Getr. / GBox: ZF 16S-221 Getr. / GBox: ZF 8S-151 Getr. / GBox: ZF 16S-151		
370.26	01.01-		 3400 700 485 # ⊗ 3482 123 631 ⊗ 1878 004 832 ⊙ 3151 263 031	430 10 GMFZ430N 430WGTZ KZIZ-6	Getr. / GBox: ZF 16S-151 Nebenantriebs-ID / PTO ID: 221	(48)	
370.26	01.01-						
370.26	01.01-						
370.26	01.01-						
370.32	01.01-						
370.32	01.01-						
370.32	01.01-						

		CODE					
--	--	------	--	--	---	---	---

RENAULT TRUCKS



















Kerax		06.97 -						
370.18	10.05-	DXI11		3400 700 399 ⊗ 3482 083 034 ⊗ 1878 004 832 ⊙ 3151 274 131	430 10 MFZ430 430WGTZ KZISZ-5	Getr. / GBox: ZF		
370.18	10.05-							
370.26	10.05-							
370.26	10.05-				3488 017 439	400 MFZ2/400X	für Fahrzeuge mit Zweis Scheibenkupplung / for vehicles with double disc clutch enthält eine Kupplungsscheibe / This part number includes one clutch disc mit Zwischenring / with intermediate ring	(77) (66)
370.26	10.05-							
370.32	10.05-							
370.32	10.05-				1862 379 032	400 10 400WGTZ	für Fahrzeuge mit Zweis Scheibenkupplung / for vehicles with double disc clutch	(77)
370.32	10.05-							
410.18	10.05-				3151 262 031	KZISZ-5	für Fahrzeuge mit Zweis Scheibenkupplung / for vehicles with double disc clutch	(77)
410.26	10.05-							
410.26	10.05-				3400 710 060 ⊗ 3482 000 552 ⊗ 1878 003 867 ⊙ 6482 000 155	430 24 MF430 430WGTZ PHIS-6/38	Getr. / GBox: AT2412C/ATO2512C	
410.26	10.05-							
410.32	10.05-							
410.32	10.05-							
385.18	06.97-	MIDR06.23.56A/41		3400 123 401 ⊗ 3482 083 252 ⊗ 1878 020 241 ⊙ 3151 250 231	430 20 MFZ430 430WGTZ KZISZ-5	Getr. / GBox: B9		
385.18/B	06.97-							
385.18T	06.97-							
385.18T	06.97-				3400 700 408 ⊗ 3482 083 252 ⊗ 1878 020 241 ⊙ 3151 000 404	430 20 MFZ430 430WGTZ KZISZ-5	Getr. / GBox: B9+35mm,B18	
385.26	06.97-							
385.26/A,385.26/B	06.97-							
385.26/A,385.26/B,385.26/C	06.97-				3400 117 532 ● ⊗ 3488 017 439 ⊗ 1862 379 031 ⊙ 3151 250 231	400 20 MFZ2/400X 400WGVZ KZISZ-5	Getr. / GBox: B9+35mm,B18 für Fahrzeuge mit Zweis Scheibenkupplung / for vehicles with double disc clutch	(77)
385.26/B	06.97-							
385.32/A,385.32/B	06.97-							
385.32/A,385.32/B,385.32/C	06.97-				3400 700 333 ⊗ 3482 083 252 ⊗ 1878 004 832 ⊙ 3151 278 941	430 10 MFZ430 430WGTZ KZIS-5	Getr. / GBox: ZF 8S-151	
385.32/B	06.97-							
					3400 700 333 ⊗ 3482 083 252 ⊗ 1878 004 832 ⊙ 3151 278 941	430 10 MFZ430 430WGTZ KZIS-5	-> 05.2001 Getr. / GBox: ZF 16S-151 bis Produktionsnummer / to production Number: CAM 16E1	(63)
					3400 700 334 ⊗ 3482 083 252 ⊗ 1878 004 832 ⊙ 3151 274 131	430 10 MFZ430 430WGTZ KZISZ-5	05.2001-> Getr. / GBox: ZF 16S-151 ab Produktionsnummer / from Production Number: CAM 17E1	(60)
					3400 700 340 ● ⊗ 3488 017 439 ⊗ 1862 379 032 ⊙ 3151 250 231	400 10 MFZ2/400X 400WGTZ KZISZ-5	-> 12.1999 Getr. / GBox: ZF 16S-151 für Fahrzeuge mit Zweis Scheibenkupplung / for vehicles with double disc clutch	(77)
				3400 700 311 ⊗ 3488 017 439 ⊗ 1862 379 032 ⊙ 3151 262 031	400 10 MFZ2/400X 400WGTZ KZISZ-5	01.2000-> Getr. / GBox: ZF 8S-151 Getr. / GBox: ZF 16S-151 Getr. / GBox: ZF 16S-221 für Fahrzeuge mit Zweis Scheibenkupplung / for vehicles with double disc clutch	(77)	
				3400 700 485 # ⊗ 3482 123 631 ⊗ 1878 004 832 ⊙ 3151 263 031	430 10 GMFZ430N 430WGTZ KZIZ-6	Getr. / GBox: ZF 16S-151 Nebenantriebs-ID / PTO ID: NMV 221	(48)	
				3400 700 409 ⊗ 3482 083 252 ⊗ 1878 026 241 ⊙ 3151 250 231	430 10 MFZ430 430WGTZ KZISZ-5	Getr. / GBox: Eaton 8209 A		

RENAULT TRUCKS

Kerax		06.97 -							
385.26T	06.97 -	MIDR06.23.56A/41	 3400 123 401 ⊗ 3482 083 252 ⊗ 1878 020 241 ⊙ 3151 250 231	430 20 MFZ430 430WGTZ KZISZ-5	Getr. / GBox: B9				
			 3400 700 408 ⊗ 3482 083 252 ⊗ 1878 020 241 ⊙ 3151 000 404	430 20 MFZ430 430WGTZ KZISZ-5	Getr. / GBox: B9+35mm,B18				
			 3400 117 532 ● ⊗ 3488 017 439 ⊗ 1862 379 031 ⊙ 3151 250 231	400 20 MFZ2/400X 400WGVZ KZISZ-5	Getr. / GBox: B9+35mm,B18 für Fahrzeuge mit Zweischeibenkupplung / for vehicles with double disc clutch	(77)			
			 3400 700 333 ⊗ 3482 083 252 ⊗ 1878 004 832 ⊙ 3151 278 941	430 10 MFZ430 430WGTZ KZIS-5	Getr. / GBox: ZF 8S-151				
			 3400 700 333 ⊗ 3482 083 252 ⊗ 1878 004 832 ⊙ 3151 278 941	430 10 MFZ430 430WGTZ KZIS-5	->05.2001 Getr. / GBox: ZF 16S-151 bis Produktionsnummer / to production Number: CAM 16E1	(63)			
			 3400 700 334 ⊗ 3482 083 252 ⊗ 1878 004 832 ⊙ 3151 274 131	430 10 MFZ430 430WGTZ KZISZ-5	05.2001-> Getr. / GBox: ZF 16S-151 ab Produktionsnummer / from Production Number: CAM 17E1	(60)			
			 3400 700 340 ● ⊗ 3488 017 439 ⊗ 1862 379 032 ⊙ 3151 250 231	400 10 MFZ2/400X 400WGTZ KZISZ-5	->12.1999 Getr. / GBox: ZF 16S-151 für Fahrzeuge mit Zweischeibenkupplung / for vehicles with double disc clutch	(77)			
			 3400 700 311 ⊗ 3488 017 439 ⊗ 1862 379 032 ⊙ 3151 262 031	400 10 MFZ2/400X 400WGTZ KZISZ-5	01.2000-> Getr. / GBox: ZF 8S-151 Getr. / GBox: ZF 16S-151 Getr. / GBox: ZF 16S-221 für Fahrzeuge mit Zweischeibenkupplung / for vehicles with double disc clutch	(77)			
			 3482 123 631	430 GMFZ430N	Getr. / GBox: ZF 16S-151 Nebenantriebs-ID / PTO ID: NMV 221	(48)			
			 1878 004 832	430 10 430WGTZ	Getr. / GBox: ZF 16S-151 Nebenantriebs-ID / PTO ID: NMV 221	(48)			
			 3151 263 031	KZIZ-6	Getr. / GBox: ZF 16S-151 Nebenantriebs-ID / PTO ID: NMV 221	(48)			
			 3400 700 409 ⊗ 3482 083 252 ⊗ 1878 026 241 ⊙ 3151 250 231	430 10 MFZ430 430WGTZ KZISZ-5	Getr. / GBox: Eaton 8209 A				
			400.18 400.18T 400.18T 400.26 400.26/A,400.26/B,400.26/C 400.26/B 400.26/B 400.26T 400.32/A,400.32/B,400.32/C 400.32/B 400.32/B	01.00 - 01.00 - 01.00 - 09.98 - 01.00 - 01.00 - 01.00 - 01.00 - 01.00 - 01.00 -	MIDR06.23.56B/41	 3400 700 409 ⊗ 3482 083 252 ⊗ 1878 026 241 ⊙ 3151 250 231	430 10 MFZ430 430WGTZ KZISZ-5	Getr. / GBox: Eaton 8209 A	
 3400 700 333 ⊗ 3482 083 252 ⊗ 1878 004 832 ⊙ 3151 278 941	430 10 MFZ430 430WGTZ KZIS-5	Getr. / GBox: ZF 8S-151							
 3400 700 333 ⊗ 3482 083 252 ⊗ 1878 004 832 ⊙ 3151 278 941	430 10 MFZ430 430WGTZ KZIS-5	->05.2001 Getr. / GBox: ZF 16S-151 bis Produktionsnummer / to production Number: CAM 16E1				(63)			
 3400 700 334 ⊗ 3482 083 252 ⊗ 1878 004 832 ⊙ 3151 274 131	430 10 MFZ430 430WGTZ KZISZ-5	05.2001-> Getr. / GBox: ZF 16S-151 ab Produktionsnummer / from Production Number: CAM 17E1				(60)			
 3400 700 311 ⊗ 3488 017 439 ⊗ 1862 379 032 ⊙ 3151 262 031	400 10 MFZ2/400X 400WGTZ KZISZ-5	Getr. / GBox: ZF 8S-151 Getr. / GBox: ZF 16S-151/221/251 für Fahrzeuge mit Zweischeibenkupplung / for vehicles with double disc clutch				(77)			
 3400 700 485 # ⊗ 3482 123 631 ⊗ 1878 004 832 ⊙ 3151 263 031	430 10 GMFZ430N 430WGTZ KZIZ-6	Getr. / GBox: ZF 16S-151 Nebenantriebs-ID / PTO ID: 221				(48)			
410		DXi11				 3400 700 399 ⊗ 3482 083 034 ⊗ 1878 004 832 ⊙ 3151 274 131	430 10 MFZ430 430WGTZ KZISZ-5	Getr. / GBox: 16S1620TD/1820TO Getr. / GBox: 1920TD/2220TO/2220TD	
						 3400 700 358 ⊗ 3482 000 552 ⊗ 1878 003 867	430 24 MF430 430WGTZ	Getr. / GBox: AT2412C/ATO2512C	
			 6482 000 155	PHIS-6/38	Getr. / GBox: AT2412C/ATO2512C				



















		CODE				
--	--	------	--	---	---	---

RENAULT TRUCKS

Kerax		06.97 -					
420.18	01.01-	dCi11C	 3400 700 334 ⊗ 3482 083 252 ⊗ 1878 004 832 ⊙ 3151 274 131	430 10 MFZ430 430WGTZ KZISZ-5	Getr. / GBox: ZF 8S-151 Getr. / GBox: ZF 16S-151 Getr. / GBox: ZF 16S-221		
420.18	01.01-		 3400 700 330 ⊗ 3482 083 252 ⊗ 1878 004 832 ⊙ 3151 250 231	430 10 MFZ430 430WGTZ KZISZ-5	Getr. / GBox: Eaton 8309/A		
420.26	01.01-		 3400 700 311 ⊗ 3488 017 439 ⊗ 1862 379 032 ⊙ 3151 262 031	400 10 MFZ2/400X 400WGTZ KZISZ-5	für Fahrzeuge mit Zweischeibenkupplung / for vehicles with double disc clutch	(77)	
420.26	01.01-		 3400 700 485 # ⊗ 3482 123 631 ⊗ 1878 004 832 ⊙ 3151 263 031	430 10 GMFZ430N 430WGTZ KZIZ-6	Getr. / GBox: ZF 16S-151 Nebenantriebs-ID / PTO ID: 221	(48)	
420.32	10.01-						
420.32	10.01-						
420.34	01.01-						
450		DXi11	 3400 700 399 ⊗ 3482 083 034 ⊗ 1878 004 832 ⊙ 3151 274 131	430 10 MFZ430 430WGTZ KZISZ-5	Getr. / GBox: 16S1620TD/1820TO Getr. / GBox: 1920TD/2220TO/2220TD		
			 3400 710 061 ⊗ 3482 000 553 ⊗ 1878 006 129 ⊙ 6482 000 155	430 24 MF430 430WGTZ PHIS-6/38	Getr. / GBox: AT2412C/ATO2512C		
450.18	10.05-	DXi11	 3400 700 399 ⊗ 3482 083 034 ⊗ 1878 004 832 ⊙ 3151 274 131	430 10 MFZ430 430WGTZ KZISZ-5	Getr. / GBox: ZF		
450.18	10.05-						
450.26	10.05-		 3488 017 439	400 MFZ2/400X	für Fahrzeuge mit Zweischeibenkupplung / for vehicles with double disc clutch enthält eine Kupplungsscheibe / This part number includes one clutch disc mit Zwischenring / with intermediate ring	(77)	(66)
450.26	10.05-						(95)
450.26	10.05-		 1862 379 032	400 10 400WGTZ	für Fahrzeuge mit Zweischeibenkupplung / for vehicles with double disc clutch	(77)	
450.32	10.05-		 3151 262 031	KZISZ-5	für Fahrzeuge mit Zweischeibenkupplung / for vehicles with double disc clutch	(77)	
450.32	10.05-		 3400 710 061 ⊗ 3482 000 553 ⊗ 1878 006 129 ⊙ 6482 000 155	430 24 MF430 430WGTZ PHIS-6/38	Getr. / GBox: AT2412C/ATO2512C		
460.32	05.06-	DXi13	 3400 710 061 ⊗ 3482 000 553 ⊗ 1878 006 129 ⊙ 6482 000 155	430 24 MF430 430WGTZ PHIS-6/38	Getr. / GBox: AT2412C/AT2512C Getr. / GBox: ATO2512C		
460.32	05.06-						
460.32	05.06-		 3400 700 470 ⊗ 3482 634 004 ⊗ 1878 003 968 ⊙ 3151 274 131	430 10 MFZ430 430WGTZ KZISZ-5	Getr. / GBox: ZF 16S-2520 TO Getr. / GBox: ZF 16S-2320 TD für Fahrzeuge mit Einscheibenkupplung / for vehicles with single disc clutch	(71)	
500.32	05.06-		 3400 700 311 ⊗ 3488 017 439 ⊗ 1862 379 032 ⊙ 3151 262 031	400 10 MFZ2/400X 400WGTZ KZISZ-5	Getr. / GBox: ZF 16S-2520 TO Getr. / GBox: ZF 16S-2320 TD für Fahrzeuge mit Zweischeibenkupplung / for vehicles with double disc clutch	(77)	
500.32	05.06-		 1863 869 037	72			
Magnum		09.90 - 06.92					
AE 380. 18 T (11GZA3)	03.90 - 09.92	MIDR06.35.40N/3,	 3400 117 001 ⊗ 3482 123 441 ⊗ 1878 020 241 ⊙ 3100 008 106	430 20 GMFZ430 430WGTZ KZISZ-5	Getr. / GBox: B9/B18		
AE 380. 19 (11AZA1)	03.90 - 09.92	MIDR06.35.40H					
AE 380. 26 6x2 (11CZA1)	03.90 - 09.92						
AE 380. TI (11GZA1)	03.90 - 09.92						
AE 420. TI	- 09.92						
AE 385. TI	- 09.92	MIDR063540L1	 3400 117 001 ⊗ 3482 123 441 ⊗ 1878 020 241 ⊙ 3100 008 106	430 20 GMFZ430 430WGTZ KZISZ-5	Getr. / GBox: B9/B18		
			 3400 123 201 ▲ ⊗ 3482 123 441 ⊗ 1878 022 841 ⊙ 3100 008 106	430 10 GMFZ430 430GTZ KZISZ-5	Getr. / GBox: Fuller		































		CODE				
--	--	------	--	---	---	---

RENAULT TRUCKS

Magnum		09.90 - 06.92								
AE 385ti.18	02.92 - 10.96	MIDR06.35.40N/ 3		3400 117 101	430 20	Getr. / GBox: B18				
AE 385ti.18T	02.92 - 10.96				⊗ 3482 123 243	MFZ430	Getr. / GBox: B9+35mm			
AE 385ti.19	02.92 - 10.96				⊗ 1878 020 241	430WGTZ				
AE 385ti.19T	02.92 - 10.96				⬢ 3100 008 204					
AE 385ti.24	02.92 - 10.96					3400 123 101 #	430 20	Getr. / GBox: B9		
AE 385ti.26	02.92 - 10.96					⊗ 3482 123 243	MFZ430			
				⊗ 1878 020 241	430WGTZ					
				⬢ 3100 008 106	KZISZ-5					
					3400 123 301 ▲	430 10	Getr. / GBox: Fuller			
				⊗ 3482 123 243	MFZ430					
				⊗ 1878 022 841	430GTZ					
				⬢ 3100 008 106	KZISZ-5					
AE 390.18	09.96 -	MIDR062465A/4 2		3400 123 401	430 20	Getr. / GBox: B9				
AE 390.18T	09.96 -				⊗ 3482 083 252	MFZ430				
AE 390.19	09.96 -				⊗ 1878 020 241	430WGTZ				
AE 390.19T	09.96 -				⬢ 3151 250 231	KZISZ-5				
AE 390.26	09.96 -					3400 700 408	430 20	Getr. / GBox: B9+35mm,B18		
				⊗ 3482 083 252	MFZ430					
				⊗ 1878 020 241	430WGTZ					
				⬢ 3151 000 404	KZISZ-5					
					3400 117 532 ●	400 20	Getr. / GBox: B9+35mm,B18			
				⊗ 3488 017 439	MFZ2/400X	für Fahrzeuge mit Zweis Scheibenkupplung / for	(77)			
				⊗ 1862 379 031	400WGVZ	vehicles with double disc clutch				
				⬢ 3151 250 231	KZISZ-5					
					3400 700 311	400 10	03.1999->			
				⊗ 3488 017 439	MFZ2/400X	Getr. / GBox: ZF 16S 221				
				⊗ 1862 379 032	400WGTZ	für Fahrzeuge mit Zweis Scheibenkupplung / for	(77)			
				⬢ 3151 262 031	KZISZ-5	vehicles with double disc clutch				
AE 420ti.18	10.92 - 12.96	MIDR063540J/3 ; MIDR063540P/4 1		3400 117 101	430 20	->08.1996				
AE 420ti.18T	10.92 - 12.96				⊗ 3482 123 243	MFZ430	Getr. / GBox: B9+35mm,B18			
AE 420ti.19	10.92 - 12.96				⊗ 1878 020 241	430WGTZ				
AE 420ti.19T	10.92 - 12.96				⬢ 3100 008 204					
AE 420ti.22T	10.92 - 10.96					3400 093 031 ●+	400 20	->08.1996		
AE 420ti.24	10.92 - 12.96					⊗ 3488 017 334	MFZ2/400X	Getr. / GBox: B9+35mm,B18		
AE 420ti.24T	10.92 - 12.96					⊗ 1862 379 031	400WGVZ	für Fahrzeuge mit Zweis Scheibenkupplung / for	(77)	
AE 420ti.26	10.92 - 12.96					⬢ 1862 379 031		vehicles with double disc clutch		
AE 420ti.26T	10.92 - 12.96				3400 700 408	430 20	09.1996->			
				⊗ 3482 083 252	MFZ430	Getr. / GBox: B9+35mm,B18				
				⊗ 1878 020 241	430WGTZ					
				⬢ 3151 000 404	KZISZ-5					
					3400 117 532 ●	400 20	09.1996->			
				⊗ 3488 017 439	MFZ2/400X	Getr. / GBox: B9+35mm,B18				
				⊗ 1862 379 031	400WGVZ	für Fahrzeuge mit Zweis Scheibenkupplung / for	(77)			
				⬢ 3151 250 231	KZISZ-5	vehicles with double disc clutch				
AE 430.18	09.96 -	MIDR06.24.65C/ 42, MIDR06.24.65B/ 42		3400 123 401	430 20	Getr. / GBox: B9				
AE 430.18T	09.96 -				⊗ 3482 083 252	MFZ430				
AE 430.19	09.96 -				⊗ 1878 020 241	430WGTZ				
AE 430.19T	09.96 -				⬢ 3151 250 231	KZISZ-5				
AE 430.26	09.96 -					3400 700 408	430 20	Getr. / GBox: B9+35mm,B18		
AE 430.26T	01.97 -					⊗ 3482 083 252	MFZ430			
AE 470.18	11.96 -					⊗ 1878 020 241	430WGTZ			
AE 470.18T	11.96 -					⬢ 3151 000 404	KZISZ-5			
AE 470.19	11.96 -						3400 117 532 ●	400 20	Getr. / GBox: B9+35mm,B18	
AE 470.19T	11.96 -					⊗ 3488 017 439	MFZ2/400X	für Fahrzeuge mit Zweis Scheibenkupplung / for	(77)	
AE 470.26	01.97 -			⊗ 1862 379 031	400WGVZ	vehicles with double disc clutch				
				⬢ 3151 250 231	KZISZ-5					
					3400 700 331	430 10	11.1997->			
				⊗ 3482 083 252	MFZ430	Getr. / GBox: ZF 16S 221				
				⊗ 1878 085 741	430WGTZ					
				⬢ 3151 000 404	KZISZ-5					
					3400 700 340 ●	400 10	11.1997->			
				⊗ 3488 017 439	MFZ2/400X	Getr. / GBox: ZF 16S 221				
				⊗ 1862 379 032	400WGTZ	für Fahrzeuge mit Zweis Scheibenkupplung / for	(77)			
				⬢ 3151 250 231	KZISZ-5	vehicles with double disc clutch				













		CODE					
--	--	------	--	--	---	---	---

RENAULT TRUCKS

Magnum		09.90 - 06.92				
AE 430.26T AE 470.26T	01.98-	MIDR06.24.65C/ 42, MIDR06.24.65B/ 42	 3400 123 401  3482 083 252  1878 020 241  3151 250 231	430 20 MFZ430 430WGTZ KZISZ-5	Getr. / GBox: B9	
	01.98-		 3400 700 408  3482 083 252  1878 020 241  3151 000 404	430 20 MFZ430 430WGTZ KZISZ-5	Getr. / GBox: B9+35mm,B18	
			 3400 117 532 ●  3488 017 439  1862 379 031  3151 250 231	400 20 MFZ2/400X 400WGVZ KZISZ-5	Getr. / GBox: B9+35mm,B18 für Fahrzeuge mit Zweischeibenkupplung / for vehicles with double disc clutch	(77)
			 3400 700 331  3482 083 252  1878 085 741  3151 000 404	430 10 MFZ430 430WGTZ KZISZ-5	Getr. / GBox: ZF 16S 221	
			 3400 700 340 ●  3488 017 439  1862 379 032  3151 250 231	400 10 MFZ2/400X 400WGTZ KZISZ-5	Getr. / GBox: ZF 16S 221 für Fahrzeuge mit Zweischeibenkupplung / for vehicles with double disc clutch	(77)
AE 440		DXI12	 3400 700 350 ⊕  3483 034 042  1878 000 634	430 24 MFZ430 430WGTZ	Getr. / GBox: VT2412B	
			 3488 000 122	400 MFZ2/400X	Getr. / GBox: 16S 221DD Getr. / GBox: 16S 122 Getr. / GBox: 16S 181 für Fahrzeuge mit Zweischeibenkupplung / for vehicles with double disc clutch enthält eine Kupplungsscheibe / This part number includes one clutch disc	(77) (66)
			 1862 379 032	400 10 400WGTZ	Getr. / GBox: 16S 221DD Getr. / GBox: 16S 122 Getr. / GBox: 16S 181 für Fahrzeuge mit Zweischeibenkupplung / for vehicles with double disc clutch	(77)
			 3151 262 031	KZISZ-5	Getr. / GBox: 16S 221DD Getr. / GBox: 16S 122 Getr. / GBox: 16S 181 für Fahrzeuge mit Zweischeibenkupplung / for vehicles with double disc clutch	(77)
			 3459 018 004	400 MFZ2/400X	Getr. / GBox: 16S 221DD Getr. / GBox: 16S 122 Getr. / GBox: 16S 181 für Fahrzeuge mit Zweischeibenkupplung / for vehicles with double disc clutch In 3488 enthalten / Contained in 3488	(77) (31)
			 3496 006 000		Getr. / GBox: 16S 221DD Getr. / GBox: 16S 122 Getr. / GBox: 16S 181 für Fahrzeuge mit Zweischeibenkupplung / for vehicles with double disc clutch langer Bügel / long handle	(77) (86)
			 1878 004 832	430 10 430WGTZ	Getr. / GBox: 16S 221DD Getr. / GBox: 16S 122 Getr. / GBox: 16S 181	
			 3151 274 131	KZISZ-5	Getr. / GBox: 16S 221DD Getr. / GBox: 16S 122 Getr. / GBox: 16S 181	

















		CODE				
--	--	------	--	---	---	---

RENAULT TRUCKS

Magnum		09.90 - 06.92					
AE 480		DXI12	 3400 700 351 ⊕ ⊗ 3483 034 043 ⊙ 1878 006 129	430 24 MFZ430 430WGTZ	Getr. / GBox: VT2412B		
			 3488 000 122	400 MFZ2/400X	Getr. / GBox: 16S 221DD Getr. / GBox: 16S 122 Getr. / GBox: 16S 181 für Fahrzeuge mit Zweischeibenkupplung / for vehicles with double disc clutch enthält eine Kupplungsscheibe / This part number includes one clutch disc	(77)	(66)
			 1862 379 032	400 10 400WGTZ	Getr. / GBox: 16S 221DD Getr. / GBox: 16S 122 Getr. / GBox: 16S 181 für Fahrzeuge mit Zweischeibenkupplung / for vehicles with double disc clutch	(77)	
			 3151 262 031	KZISZ-5	Getr. / GBox: 16S 221DD Getr. / GBox: 16S 122 Getr. / GBox: 16S 181 für Fahrzeuge mit Zweischeibenkupplung / for vehicles with double disc clutch	(77)	
			 3459 018 004	400 MFZ2/400X	Getr. / GBox: 16S 221DD Getr. / GBox: 16S 122 Getr. / GBox: 16S 181 für Fahrzeuge mit Zweischeibenkupplung / for vehicles with double disc clutch In 3488 enthalten / Contained in 3488	(77)	(31)
			 3496 006 000		Getr. / GBox: 16S 221DD Getr. / GBox: 16S 122 Getr. / GBox: 16S 181 für Fahrzeuge mit Zweischeibenkupplung / for vehicles with double disc clutch langer Bügel / long handle	(77)	(86)
			 3151 274 131	KZISZ-5	Getr. / GBox: 16S 221DD Getr. / GBox: 16S 122 Getr. / GBox: 16S 181		
AE 500. (11CWA1)	01.92 -	MackEE9	 3400 093 031 ⊕ ⊗ 3488 017 334 ⊙ 1862 379 031	400 20 MFZ2/400X 400WGVZ			
AE 500. 18 T (11GWA3)	01.90 - 04.92	MackEE9	 3400 117 001 ⊗ 3482 123 441 ⊙ 1878 020 241 ⊖ 3100 008 106	430 20 GMFZ430 430WGTZ KZISZ-5	Getr. / GBox: B18		
AE 500. 19 (11AWA1)	01.90 - 04.92						
AE 500. 19 T (11GWA1)	01.90 - 04.92						
AE 500. 22 T (11GWA1)	01.90 - 04.92						
AE 500. 26 6x2 (11CWA1)	01.90 - 04.92						
AE 520.18	10.92 - 05.96	MackEE9	 3400 117 532 ⊗ 3488 017 439 ⊙ 1862 379 031 ⊖ 3151 250 231	400 20 MFZ2/400X 400WGVZ KZISZ-5	04.1995-> Getr. / GBox: B9+35mm,B18 für Fahrzeuge mit Zweischeibenkupplung / for vehicles with double disc clutch		(77)
AE 520.18T	10.92 - 05.96						
AE 520.19	10.92 - 05.96						
AE 520.19T	10.92 - 05.96						
AE 520.22T	10.92 - 05.96						
AE 520.24	10.92 - 05.96						
AE 520.24T	10.92 - 05.96						
AE 520.26T	10.92 - 05.96						
AE 520.26	10.92 -	MackEE9	 3400 117 532 ⊗ 3488 017 439 ⊙ 1862 379 031 ⊖ 3151 250 231	400 20 MFZ2/400X 400WGVZ KZISZ-5	04.1995 - 05.1996 Getr. / GBox: B9+35mm,B18 für Fahrzeuge mit Zweischeibenkupplung / for vehicles with double disc clutch	(77)	
AE 560.18	04.96 -	MackEE9	 3400 117 631 ▲ ⊗ 3488 017 442 ⊙ 1878 002 455 ⊖ 3151 250 231	400 20 MFZ2/400X 400WGTZ KZISZ-5	Getr. / GBox: B9+35mm,18 für Fahrzeuge mit Zweischeibenkupplung / for vehicles with double disc clutch		(77)
AE 560.18T	04.96 -						
AE 560.19	04.96 -						
AE 560.19T	04.96 -						
AE 560.26	04.96 -						
AE 560.26T	01.97 -						
AE 560.26T	01.98 -						













		CODE				
--	--	------	--	---	---	---





RENAULT TRUCKS

Magnum		09.90 - 06.92					
DXi 12 440.18	10.04 - 04.06	DXi12	 3400 700 350 ⊕ ⊗ 3483 034 042 ⊗ 1878 000 634	430 24 MFZ430 430WGTZ	Getr. / GBox: VT2412B		
DXi 12 440.18 T	10.04 - 04.06		 3488 000 122	400 MFZ2/400X	Getr. / GBox: 16S-2220 / 16S-221DD Getr. / GBox: 16S-122 / 16S-181 für Fahrzeuge mit Zweischeibenkupplung / for vehicles with double disc clutch enthält eine Kupplungsscheibe / This part number includes one clutch disc	(77)	
DXi 12 440.24	10.04 - 04.06					(66)	
DXi 12 440.26	10.04 - 04.06						
DXi 12 440.26 T	10.04 - 04.06						
DXi 12 440.26 T	10.04 - 04.06						
DXi 12 440.26 T	10.04 - 04.06						
			 1862 379 032	400 10 400WGTZ	Getr. / GBox: 16S-2220 / 16S-221DD Getr. / GBox: 16S-122 / 16S-181 für Fahrzeuge mit Zweischeibenkupplung / for vehicles with double disc clutch	(77)	
			 3151 262 031	KZISZ-5	Getr. / GBox: 16S-2220 / 16S-221DD Getr. / GBox: 16S-122 / 16S-181 für Fahrzeuge mit Zweischeibenkupplung / for vehicles with double disc clutch	(77)	
			 3496 006 000		Getr. / GBox: 16S-2220 / 16S-221DD Getr. / GBox: 16S-122 / 16S-181 für Fahrzeuge mit Zweischeibenkupplung / for vehicles with double disc clutch langer Bügel / long handle	(77) (86)	
			 3400 700 399 ⊗ 3482 083 034 ⊗ 1878 004 832 ⊗ 3151 274 131	430 10 MFZ430 430WGTZ KZISZ-5	Getr. / GBox: 16S-221DD / 16S-122 Getr. / GBox: 16S-181 / 16S-222 Getr. / GBox: 16S-220		
DXi 12 480.18	10.04 - 04.06	DXi12	 3400 700 351 ⊕ ⊗ 3483 034 043 ⊗ 1878 006 129	430 24 MFZ430 430WGTZ	Getr. / GBox: VT2412B		
DXi 12 480.18 T	10.04 - 04.06		 3488 000 122	400 MFZ2/400X	Getr. / GBox: 16S-2220 / 16S-221DD Getr. / GBox: 16S-122 / 16S-181 für Fahrzeuge mit Zweischeibenkupplung / for vehicles with double disc clutch enthält eine Kupplungsscheibe / This part number includes one clutch disc	(77)	
DXi 12 480.24	10.04 - 04.06					(66)	
DXi 12 480.26	10.04 - 04.06						
DXi 12 480.26 T	10.04 - 04.06						
DXi 12 480.26 T	10.04 - 04.06						
DXi 12 480.26 T	10.04 - 04.06						
				 1862 379 032	400 10 400WGTZ	Getr. / GBox: 16S-2220 / 16S-221DD Getr. / GBox: 16S-122 / 16S-181 für Fahrzeuge mit Zweischeibenkupplung / for vehicles with double disc clutch	(77)
				 3151 262 031	KZISZ-5	Getr. / GBox: 16S-2220 / 16S-221DD Getr. / GBox: 16S-122 / 16S-181 für Fahrzeuge mit Zweischeibenkupplung / for vehicles with double disc clutch	(77)
				 3496 006 000		Getr. / GBox: 16S-2220 / 16S-221DD Getr. / GBox: 16S-122 / 16S-181 für Fahrzeuge mit Zweischeibenkupplung / for vehicles with double disc clutch langer Bügel / long handle	(77) (86)
				 3400 700 399 ⊗ 3482 083 034 ⊗ 1878 004 832 ⊗ 3151 274 131	430 10 MFZ430 430WGTZ KZISZ-5	Getr. / GBox: 16S-2220	
				 3400 700 382 ⊗ 3482 000 691 ⊗ 1878 003 968 ⊗ 3151 274 131	430 10 MFZ430 430WGTZ KZISZ-5	Getr. / GBox: 16S-222	
				 3482 000 246	430 MFZ430	Getr. / GBox: 16S-221DD / 16S-122 Getr. / GBox: 16S-181	
				 1878 003 968	430 10 430WGTZ	Getr. / GBox: 16S-221DD / 16S-122 Getr. / GBox: 16S-181	
			 3151 274 131	KZISZ-5	Getr. / GBox: 16S-221DD / 16S-122 Getr. / GBox: 16S-181		

		CODE					
--	--	------	--	--	---	---	---







































































RENAULT TRUCKS

Magnum		09.90 - 06.92							
DXi 13 440.19	03.09-	DXi13		3400 710 061 ⊗ 3482 000 553 ⊗ 1878 006 129 ⊙ 6482 000 155	430 24 MFZ430 430WGTZ PHIS-6/38	Getr. / GBox: AT2412C/AT2512C Getr. / GBox: ATO2512C			
DXi 13 480.19	03.09-			3400 700 470 ⊗ 3482 634 004 ⊗ 1878 003 968 ⊙ 3151 274 131	430 10 MFZ430 430WGTZ KZISZ-5	Getr. / GBox: ZF 16S-2520 TO Getr. / GBox: ZF 16S-2320 TD für Fahrzeuge mit Einscheibenkupplung / for vehicles with single disc clutch	(71)		
DXi 13 520.18	08.09-			3400 700 311 ⊗ 3488 017 439 ⊗ 1862 379 032 ⊙ 3151 262 031	400 10 MFZ2/400X 400WGTZ KZISZ-5	Getr. / GBox: ZF 16S-2520 TO Getr. / GBox: ZF 16S-2320 TD für Fahrzeuge mit Zweischeibenkupplung / for vehicles with double disc clutch	(77)		
DXi 13 520.25	08.09-			3400 700 438 ⊗ 3482 634 004 ⊗ 1878 003 968 ⊙ 3151 001 035	430 10 MFZ430 430WGTZ	Getr. / GBox: 16S2230			
DXi 13 460.18 T	05.06-		DXi13		3400 710 061 ⊗ 3482 000 553 ⊗ 1878 006 129 ⊙ 6482 000 155	430 24 MFZ430 430WGTZ PHIS-6/38	Getr. / GBox: AT2412C/AT2512C Getr. / GBox: ATO2512C		
DXi 13 460.24	05.06-				3400 700 470 ⊗ 3482 634 004 ⊗ 1878 003 968 ⊙ 3151 274 131	430 10 MFZ430 430WGTZ KZISZ-5	Getr. / GBox: ZF 16S-2520 TO Getr. / GBox: ZF 16S-2320 TD für Fahrzeuge mit Einscheibenkupplung / for vehicles with single disc clutch	(71)	
DXi 13 500.24	05.06-				3400 700 311 ⊗ 3488 017 439 ⊗ 1862 379 032 ⊙ 3151 262 031	400 10 MFZ2/400X 400WGTZ KZISZ-5	Getr. / GBox: ZF 16S-2520 TO Getr. / GBox: ZF 16S-2320 TD für Fahrzeuge mit Zweischeibenkupplung / for vehicles with double disc clutch	(77)	
E.TECH 400.18	05.00-			MACKE.TECHC /46, MACKE.TECHA /46		3400 700 334 ⊗ 3482 083 252 ⊗ 1878 004 832 ⊙ 3151 274 131	430 10 MFZ430 430WGTZ KZISZ-5	->03.2003	
E.TECH 480.18	05.00-					3400 700 332 ⊗ 3482 083 252 ⊗ 1878 004 832 ⊙ 3151 000 144	430 10 MFZ430 430WGTZ KZISZ-5	03.2003->	
E.TECH 480.26T	05.00-					3400 700 311 ⊗ 3488 017 439 ⊗ 1862 379 032 ⊙ 3151 262 031	400 10 MFZ2/400X 400WGTZ KZISZ-5	für Fahrzeuge mit Zweischeibenkupplung / for vehicles with double disc clutch	(77)
E.TECH 440.18	05.00-		MACKE.TECHB /46			3400 700 332 ⊗ 3482 083 252 ⊗ 1878 004 832 ⊙ 3151 000 144	430 10 MFZ430 430WGTZ KZISZ-5		
E.TECH 440.26T	05.00-					3400 700 311 ⊗ 3488 017 439 ⊗ 1862 379 032 ⊙ 3151 262 031	400 10 MFZ2/400X 400WGTZ KZISZ-5	für Fahrzeuge mit Zweischeibenkupplung / for vehicles with double disc clutch	(77)
E.TECH 480.26T	05.00-	MACKE.TECHC /46, MACKE.TECHB /46		3400 700 311 ⊗ 3488 017 439 ⊗ 1862 379 032 ⊙ 3151 262 031	400 10 MFZ2/400X 400WGTZ KZISZ-5	für Fahrzeuge mit Zweischeibenkupplung / for vehicles with double disc clutch	(77)		

Major		05.91 - 10.96					
R 340ti.16/T	05.91 - 10.96	MIDR06.20.45E, MIDR06.20.45E 2, MIDR06.20.45E 3		3400 123 201 ▲ ⊗ 3482 123 441 ⊗ 1878 022 841 ⊙ 3100 008 106	430 10 GMFZ430 430GTZ KZISZ-5	->09.1992 Getr. / GBox: Eaton	
R 340ti.17	05.91 - 10.96			3400 116 601 ⊗ 3482 097 141 ⊗ 1878 020 241 ⊙ 3100 008 106	430 20 GMFZ430 430WGTZ KZISZ-5	->09.1992 Getr. / GBox: B9/B18	
R 340ti.19/T	05.91 - 10.96			3400 123 301 ▲ ⊗ 3482 123 243 ⊗ 1878 022 841 ⊙ 3100 008 106	430 10 MFZ430 430GTZ KZISZ-5	10.1992-> Getr. / GBox: Fuller	
R 340ti.24	05.91 - 10.96			3400 123 101 # ⊗ 3482 123 243 ⊗ 1878 020 241 ⊙ 3100 008 106	430 20 MFZ430 430WGTZ KZISZ-5	Getr. / GBox: B9	
				3400 117 101	430 20	Getr. / GBox: B9+35mm,B18	







		CODE				
--	--	------	--	---	---	---













RENAULT TRUCKS

Major		05.91 - 10.96				
R 340ti.18/T R 340ti.26 R 350.18/T	05.91 - 10.96 05.91 - 10.96 05.91 - 12.92	MIDR06.35.40G MIDR06.20.45E, MIDR06.20.45E 2, MIDR06.20.45E 3	 3400 117 001  3482 123 441  1878 020 241  3100 008 106  3400 093 031 ⊕  3488 017 334  1862 379 031  3400 117 101  3482 123 243  1878 020 241  3100 008 204	430 20 GMFZ430 430WGTZ KZISZ-5 400 20 MFZ2/400X 400WGVZ 430 20 MFZ430 430WGTZ	->09.1992 Getr. / GBox: B9/B18 für Fahrzeuge mit Zweischeibenkupplung / for vehicles with double disc clutch Getr. / GBox: B9+35mm,B18	(77)
R 350.17 R 350.17 R 350.17/T R 350.18 R 350.18 R 350.18 R 350.19 R 350.19/T R 350.19/TB R 350.24 R 350.26	05.91 - 12.92 05.91 - 12.92 05.91 - 12.92 05.91 - 12.92 05.91 - 12.92 05.91 - 12.92 05.91 - 12.92 05.91 - 12.92 05.91 - 12.92 05.91 - 12.92	MIDR06.35.40G	 3400 116 601  3482 097 141  1878 020 241  3100 008 106  3400 123 201 ▲  3482 123 441  1878 022 841  3100 008 106  3400 117 101  3482 123 243  1878 020 241  3100 008 204  3400 123 101 #  3482 123 243  1878 020 241  3100 008 106	430 20 GMFZ430 430WGTZ KZISZ-5 430 10 GMFZ430 430GTZ KZISZ-5 430 20 MFZ430 430WGTZ KZISZ-5 430 20 MFZ430 430WGTZ KZISZ-5	->09.1992 Getr. / GBox: B9/B18 ->09.1992 Getr. / GBox: Fuller 10.1992-> Getr. / GBox: B9+35mm 10.1992-> Getr. / GBox: B9	
R 380.22/T R 380.25	05.91 - 12.92 05.91 - 12.92	MIDR06.35.40H	 3400 117 001  3482 123 441  1878 020 241  3100 008 106  3400 123 201 ▲  3482 123 441  1878 022 841  3100 008 106  3400 123 101 #  3482 123 243  1878 020 241  3100 008 106  3400 117 101  3482 123 243  1878 020 241  3100 008 204	430 20 GMFZ430 430WGTZ KZISZ-5 430 10 GMFZ430 430GTZ KZISZ-5 430 20 MFZ430 430WGTZ KZISZ-5 430 20 MFZ430 430WGTZ	->09.1992 Getr. / GBox: B9/B18 ->09.1992 Getr. / GBox: Eaton 14613 10.1992-> Getr. / GBox: B9 10.1992-> Getr. / GBox: B9+35mm,B18	
R 385ti.17,R 380.17 R 385ti.18,R 380.18 R 385ti.18,R 380.18 R 385ti.18,R 380.18 R 385ti.18/T,R 380.18/T R 385ti.19,R 380.19 R 385ti.19/T,R 380.19/T R 385ti.22/T,R 380.19/TB R 385ti.24,R 380.24 R 385ti.25,R 380.25 R 385ti.25/T,R 380.25/T R 385ti.26 R 385ti.26 R 385ti.26,R 380.26 R 385ti.26/T,R 380.26/T	05.91 - 10.96 05.91 - 10.96 05.91 - 10.96 05.91 - 10.96 05.91 - 10.96 05.91 - 10.96 05.91 - 10.96 05.91 - 10.96 05.91 - 10.96 05.91 - 10.96 12.91 - 10.96 12.91 - 10.96 05.91 - 10.96 05.91 - 10.96	MIDR06.35.40L 1, MIDR06.35.40N/ 3, MIDR06.35.40H	 3400 117 001  3482 123 441  1878 020 241  3100 008 106  3400 123 201 ▲  3482 123 441  1878 022 841  3100 008 106  3400 123 301 ▲  3482 123 243  1878 022 841  3100 008 106  3400 123 101 #  3482 123 243  1878 020 241  3100 008 106  3400 117 101  3482 123 243  1878 020 241  3100 008 204	430 20 GMFZ430 430WGTZ KZISZ-5 430 10 GMFZ430 430GTZ KZISZ-5 430 10 MFZ430 430GTZ KZISZ-5 430 20 MFZ430 430WGTZ KZISZ-5 430 20 MFZ430 430WGTZ	->09.1992 Getr. / GBox: B9/B18 ->09.1992 Getr. / GBox: Eaton RTX 14613 10.1992-> Getr. / GBox: Eaton 10.1992-> Getr. / GBox: B9 10.1992-> Getr. / GBox: B9+35mm,B18	
R 420ti.18/T R 420ti.19/T R 420ti.19/T R 420ti.22/T R 420ti.24/TS R 420ti.26/TS R 420ti.35/TS	10.92 - 10.96 10.92 - 10.96 10.92 - 10.96 10.92 - 10.96 04.92 - 10.96 04.92 - 10.96 04.92 - 10.96	MIDR06.35.40J 1, MIDR06.35.40J/ 3	 3400 117 101  3482 123 243  1878 020 241  3100 008 204  3400 093 031 ⊕  3488 017 334  1862 379 031	430 20 MFZ430 430WGTZ 400 20 MFZ2/400X 400WGVZ	Getr. / GBox: B9+35mm,B18	

		CODE					
--	--	------	--	--	---	---	---











































RENAULT TRUCKS

Major		05.91 - 10.96					
RI 357	-09.92	MIDRL1063540	 3400 117 001 ⊗ 3482 123 441 ⊗ 1878 020 241 ⊙ 3100 008 106	430 20 GMFZ430 430WGTZ KZISZ-5	Getr. / GBox: B9/B18		
			 3400 123 201 ▲ ⊗ 3482 123 441 ⊗ 1878 022 841 ⊙ 3100 008 106	430 10 GMFZ430 430GTZ KZISZ-5	Getr. / GBox: Fuller		
360	04.82-	MIVS083530	 3400 116 601 ⊗ 3482 097 141 ⊗ 1878 020 241 ⊙ 3100 008 106	430 20 GMFZ430 430WGTZ KZISZ-5	Getr. / GBox: B9/B18		
360	01.86-	MIVS083530	 3400 123 201 ▲ ⊗ 3482 123 441 ⊗ 1878 022 841 ⊙ 3100 008 106	430 10 GMFZ430 430GTZ KZISZ-5			
360	-12.86	MIVS083530	 3482 097 141	430 GMFZ430	Getr. / GBox: Fuller		
			 1878 022 841	430 10 430GTZ	Getr. / GBox: Fuller		

Manager		09.91 - 10.96								
G 200.13	09.91 - 03.93	MIDRO60226H	 3400 700 339 ⊗ 3482 124 041 ⊗ 1878 001 729 ⊙ 3151 270 341	350 10 MF350 350GTD KZIS-3	Getr. / GBox: ZFS6.36S					
G 200.15	09.91 - 03.93									
G 200.16	09.91 - 03.93									
G 200.16	09.91 - 03.93									
G 200.17	09.91 - 03.93									
G 200.18	09.91 - 03.93									
G 210.16	05.92 - 10.96	MIDRO60226H	 3400 700 339 ⊗ 3482 124 041 ⊗ 1878 001 729 ⊙ 3151 270 341	350 10 MF350 350GTD KZIS-3	Getr. / GBox: ZFS6.36S Getr. / GBox: Eaton 41067					
G 210.18	05.92 - 10.96									
G 220.17 BOM	09.91 - 10.96	MIDS062045J	 1878 049 041 #	430 16 430WGTZ	->06.1995 Getr. / GBox: G406/409					
G 220.17 BOM	09.91 - 10.96					 1897 376 506	KZA-4,5	->06.1995 Getr. / GBox: G406/409		
G 220.19 BOM	09.91 - 10.96					 3400 700 341 # ⊗ 3482 083 044 ⊗ 1878 049 041 ⊙ 3100 008 106	430 16 MFZ430 430WGTZ KZISZ-5	07.1995-> Getr. / GBox: G406/409 Getr. / GBox: G406/409 ACS		
G 230.13 SP	09.91 - 03.93	MIDS062030P	 3482 037 141	380 GM380	11.1992-> Getr. / GBox: 6.69,B6					
						 3482 083 044	430 MFZ430			
						 3100 008 106 ⊙ 3151 234 132 ⊙ 3180 000 009	KZISZ-5 KZISZ-5	Beinhaltet Ausrücker und Montagesatz / Contains releaser and fitting kit	(14)	
G 230ti.13	09.91 - 03.93	MIDRO60226D	 3482 037 141	380 GM380	Getr. / GBox: G406/409					
G 230ti.15	09.91 - 03.93									
G 230ti.16	09.91 - 10.96					 3151 000 285	KZI-4	Getr. / GBox: G406/409		
G 230ti.16	09.91 - 10.96									
G 230ti.17	09.91 - 10.96									
G 230ti.18	05.92 - 10.96									
G 230ti.18	05.92 - 10.96									
G 230ti.19	09.91 - 10.96									
G 230ti.19	09.91 - 10.96									
G 270.13 SP	03.93 - 10.96	MIDRO62045B/ 3	 3400 117 201 ⊗ 3482 083 044 ⊗ 1878 020 241 ⊙ 3100 008 204	430 20 MFZ430 430WGTZ	Getr. / GBox: B9+35mm/B18					
G 270.14 SP	03.93 - 10.96									
G 270.18,G 270.17	11.92 - 10.96					 3400 117 202 ⊗ 3482 083 044 ⊗ 1878 020 241 ⊙ 3100 008 106	430 20 MFZ430 430WGTZ KZISZ-5	Getr. / GBox: B9		





















		CODE					
--	--	------	--	--	---	---	---

RENAULT TRUCKS

Manager		09.91 - 10.96				
G 280.13,G 270.13	09.91 - 10.96	MIDS062045B	 3400 116 801  3482 097 141  1878 027 442  3100 008 106	430 20 GMFZ430 430GTZ KZISZ-5	->09.1992 Getr. / GBox: B9,B18	
G 280.15,G 270.15	09.91 - 10.96		 3400 117 202  3482 083 044  1878 020 241  3100 008 106	430 20 MFZ430 430WGTZ KZISZ-5	10.1992-> Getr. / GBox: B9	
G 280.15/T,G 270.15/T	09.91 - 10.96		 3400 117 201  3482 083 044  1878 020 241  3100 008 204	430 20 MFZ430 430WGTZ	Getr. / GBox: B9+35mm,B18	
G 280.16	09.91 - 03.93		 3400 700 329  3482 083 044  1878 022 841  3100 008 106	430 10 MFZ430 430GTZ KZISZ-5	Getr. / GBox: Fuller	
G 280.16,G 270.16	09.91 - 10.96		 1882 022 101	420 G420XN	Getr. / GBox: ZF 16S-130 Nebenantriebs-ID / PTO ID: NMV 130 E	(48)
G 280.17,G 270.18	09.91 - 10.96		 1878 003 276	420 10 420GTZ	Getr. / GBox: ZF 16S-130 Nebenantriebs-ID / PTO ID: NMV 130 E	(48)
G 280.17/T,G 270.17/T	09.91 - 10.96		 3151 204 001	KZI-6	Getr. / GBox: ZF 16S-130 mit Schmierrohranschluß / with lubricating pipe coupling Nebenantriebs-ID / PTO ID: NMV 130 E	(91) (48)
G 280.18,G 270.18,G 270.17	09.91 - 10.96					
G 280.19	09.91 - 03.93					
G 280.19,G 270.19	09.91 - 10.96					
G 280.24	09.91 - 03.93					
G 280.26,G 270.26	09.91 - 10.96					
G 300.13	09.91 - 10.96	MIDR06.20.45D 3, MIDR06.20.45D	 3400 123 201 ▲  3482 123 441  1878 022 841  3100 008 106	430 10 GMFZ430 430GTZ KZISZ-5	->09.1992 Getr. / GBox: ZF 16S-130 Getr. / GBox: Eaton RTXF 116	
G 300.15	09.91 - 10.96		 3400 116 801  3482 097 141  1878 027 442  3100 008 106	430 20 GMFZ430 430GTZ KZISZ-5	->09.1992 Getr. / GBox: B9,B18	
G 300.15/T	09.91 - 10.96		 3400 117 202  3482 083 044  1878 020 241  3100 008 106	430 20 MFZ430 430WGTZ KZISZ-5	10.1992-> Getr. / GBox: B9	
G 300.16	09.91 - 10.96		 3400 117 201  3482 083 044  1878 020 241  3100 008 204	430 20 MFZ430 430WGTZ	10.1992-> Getr. / GBox: B9+35mm,B18	
G 300.16	09.91 - 10.96		 3400 116 701  3482 097 141  1878 026 241  3100 008 106	430 10 GMFZ430 430WGTZ KZISZ-5	10.1992-> Getr. / GBox: ZF S6-90	
G 300.17	09.91 - 10.96		 1882 022 101	420 G420XN	Getr. / GBox: ZF 16S-130+ Nebenantriebs-ID / PTO ID: NMV130E	(48)
G 300.17/T	09.92 - 10.96		 1878 003 276	420 10 420GTZ	Getr. / GBox: ZF 16S-130+ Nebenantriebs-ID / PTO ID: NMV130E	(48)
G 300.18	09.92 - 10.96		 3151 204 001	KZI-6	Getr. / GBox: ZF 16S-130+ mit Schmierrohranschluß / with lubricating pipe coupling Nebenantriebs-ID / PTO ID: NMV130E	(91) (48)
G 300.18	09.92 - 10.96					
G 300.18	09.92 - 10.96					
G 300.18	09.92 - 10.96					
G 300.19	09.91 - 03.93					
G 300.19	09.91 - 10.96					
G 300.19/T	09.91 - 10.96					
G 300.19/T	09.91 - 10.96					
G 300.24	09.91 - 10.96					
G 300.25	09.91 - 10.96					
G 300.25	09.91 - 10.96					
G 300.26	09.91 - 10.96					
G 300.26	09.91 - 10.96					
G 300.26 CIT	09.91 - 10.96					
G 300.26/T	09.91 - 10.96					











		CODE				
--	--	------	--	---	---	---

RENAULT TRUCKS

Manager		09.91 - 10.96				
G 300.24 G 300.24	09.91 - 10.96	MIDR06.20.45D 3, MIDR06.20.45D	 3400 123 201 ▲ ⊗ 3482 123 441 ⊗ 1878 022 841 ◊ 3100 008 106	430 10 GMFZ430 430GTZ KZISZ-5	->09.1992 Getr. / GBox: ZF 16S-130 Getr. / GBox: Eaton RTXF 116	
	09.91 - 10.96		 3400 116 801 ⊗ 3482 097 141 ⊗ 1878 027 442 ◊ 3100 008 106	430 20 GMFZ430 430GTZ KZISZ-5	->09.1992 Getr. / GBox: B9,B18	
			 3400 117 202 ⊗ 3482 083 044 ⊗ 1878 020 241 ◊ 3100 008 106	430 20 MFZ430 430WGTZ KZISZ-5	10.1992-> Getr. / GBox: B9	
			 3400 117 201 ⊗ 3482 083 044 ⊗ 1878 020 241 ◊ 3100 008 204	430 20 MFZ430 430WGTZ	10.1992-> Getr. / GBox: B9+35mm,B18	
			 3400 116 701 ⊗ 3482 097 141 ⊗ 1878 026 241 ◊ 3100 008 106	430 10 GMFZ430 430WGTZ KZISZ-5	10.1992-> Getr. / GBox: ZF S6-90	
			 1882 022 101	420 G420XN	Getr. / GBox: ZF 16S-130+ Nebenantriebs-ID / PTO ID: NMV130E	(48)
			 1866 030 102	250 32 250/210GS	Getr. / GBox: ZF 16S-130+ Nebenantriebs-ID / PTO ID: NMV130E max. übertragbares Motormoment [Nm] / max. transmittable engine torque [Nm]: 2200	(48) (87)
			 1878 003 276	420 10 420GTZ	Getr. / GBox: ZF 16S-130+ Nebenantriebs-ID / PTO ID: NMV130E	(48)
	 3151 204 001	KZI-6	Getr. / GBox: ZF 16S-130+ mit Schmierrohranschluß / with lubricating pipe coupling Nebenantriebs-ID / PTO ID: NMV130E	(91) (48)		
G 330.13 G 330.15 G 330.17 G 330.18 G 330.19 G 330.24 G 330.26	09.91 - 03.93	MIDR062045H	 3400 123 201 ▲ ⊗ 3482 123 441 ⊗ 1878 022 841 ◊ 3100 008 106	430 10 GMFZ430 430GTZ KZISZ-5	Getr. / GBox: Eaton RTXF 116	
	09.91 - 03.93		 3400 116 601 ⊗ 3482 097 141 ⊗ 1878 020 241 ◊ 3100 008 106	430 20 GMFZ430 430WGTZ KZISZ-5	10.1992-> Getr. / GBox: B9/B18	
	09.91 - 03.93		 1882 022 101	420 G420XN	Getr. / GBox: ZF 16S-130 Nebenantriebs-ID / PTO ID: NMV 130 E	(48)
	09.91 - 03.93		 1878 003 276	420 10 420GTZ	Getr. / GBox: ZF 16S-130 Nebenantriebs-ID / PTO ID: NMV 130 E	(48)
	09.91 - 03.93		 3151 204 001	KZI-6	Getr. / GBox: ZF 16S-130 mit Schmierrohranschluß / with lubricating pipe coupling Nebenantriebs-ID / PTO ID: NMV 130 E	(91) (48)
G 340ti.16,G 330.16 G 340ti.16,G 330.16 G 340ti.17,G 330.19 G 340ti.17/T,G 330.17/T G 340ti.18,G 330.18 G 340ti.18/T G 340ti.19,G 330.19 G 340ti.19/T,G 330.19/T G 340ti.19/T,G 330.19/T,G 330.17/T G 340ti.26,G 330.26	09.91 - 10.96	MIDR062045H	 3400 116 601 ⊗ 3482 097 141 ⊗ 1878 020 241 ◊ 3100 008 106	430 20 GMFZ430 430WGTZ KZISZ-5	->09.1992 Getr. / GBox: B9/B18	
	09.91 - 10.96		 3400 123 201 ▲ ⊗ 3482 123 441 ⊗ 1878 022 841 ◊ 3100 008 106	430 10 GMFZ430 430GTZ KZISZ-5	->09.1992 Getr. / GBox: ZF 16S-130	
	09.91 - 10.96		 3400 117 201 ⊗ 3482 083 044 ⊗ 1878 020 241 ◊ 3100 008 204	430 20 MFZ430 430WGTZ	10.1992-> Getr. / GBox: B9+35mm,B18	
	09.91 - 10.96		 3400 117 202 ⊗ 3482 083 044 ⊗ 1878 020 241 ◊ 3100 008 106	430 20 MFZ430 430WGTZ KZISZ-5	10.1992-> Getr. / GBox: B9	
	02.92 - 10.96		 3400 700 329 ⊗ 3482 083 044 ⊗ 1878 022 841 ◊ 3100 008 106	430 10 MFZ430 430GTZ KZISZ-5	10.1992-> Getr. / GBox: Eaton	
	09.91 - 10.96					
Maxter		10.92 - 06.97				
G 230ti.19 G 230ti.19	10.92 - 05.95 10.92 - 05.95	MIDR06.02.26D, MIDR06.02.26X	 3482 000 270 #	380 GM380		



		CODE				
--	--	------	--	---	---	---











RENAULT TRUCKS

Maxter		10.92 - 06.97				
G 280.18	10.92 - 03.93	MIDS062045B		3400 117 201 ⊕ 3482 083 044 ⊕ 1878 020 241 ⊕ 3100 008 204	430 20 MFZ430 430WGTZ	Getr. / GBox: B9+35mm,B18
G 280.18/T	10.92 - 03.93					
G 280.18	10.92 - 03.93			3400 117 202 ⊕ 3482 083 044 ⊕ 1878 020 241 ⊕ 3100 008 106	430 20 MFZ430 430WGTZ KZISZ-5	Getr. / GBox: B9
G 300.18	10.92 - 10.96	MIDR06.20.45E/41,		3400 117 201 ⊕ 3482 083 044 ⊕ 1878 020 241 ⊕ 3100 008 204	430 20 MFZ430 430WGTZ	Getr. / GBox: B9+35mm,B18
G 300.18	10.92 - 10.96	MIDR06.20.45D				
G 300.18	10.92 - 10.96	3,				
G 300.18	10.92 - 10.96	MIDR06.20.45D/41,		3400 117 202 ⊕ 3482 083 044 ⊕ 1878 020 241 ⊕ 3100 008 106	430 20 MFZ430 430WGTZ KZISZ-5	Getr. / GBox: B9
G 300.19	10.92 - 10.96	MIDR06.20.45E				
G 300.19	02.96 - 06.97	3,				
G 300.19	10.92 - 10.96	MIDR06.20.45D				
G 300.19	02.96 - 06.97					
G 300.19/T	10.92 - 10.96					
G 300.19	10.92 - 10.96					
G 300.26	10.92 - 10.96					
G 300.26	10.92 - 10.96					
G 300.26	10.92 - 10.96					
G 300.26	10.92 - 10.96					
G 300.26	10.92 - 10.96					
G 300.26	10.92 - 10.96					
G 340ti.19	10.92 - 06.97					
G 340ti.19	10.92 - 06.97					
G 340ti.19/T	10.92 - 06.97					
G 340ti.19/T	10.92 - 06.97					
G 340ti.25/A,G 340ti.25/B	10.92 - 06.97					
G 340ti.25/A,G 340ti.25/B	10.92 - 06.97					
G 340ti.26/C	10.92 - 06.97					
G 340ti.26/B	10.92 - 06.97					
G 340ti.26/C	10.92 - 06.97					
G 340ti.26,G 340ti.26/B	10.92 - 06.97					
G 340ti.26	10.92 - 06.97					
G 340ti.32/A,G 340ti.32/B,G 340ti.32/C	10.92 - 06.97					
G 340ti.32,G 340ti.32/B	10.92 - 06.97					
G 340ti.32/A,G 340ti.32/B,G 340ti.32/C	10.92 - 06.97					
G 340ti.34	10.92 - 06.97					
G 340ti.34	10.92 - 06.97	MIDR06.20.45E/41,		3400 117 201 ⊕ 3482 083 044 ⊕ 1878 020 241 ⊕ 3100 008 204	430 20 MFZ430 430WGTZ	Getr. / GBox: B9+35mm Getr. / GBox: B18
G 340ti.34	10.92 - 06.97	MIDR06.20.45E				
G 340ti.40	10.92 - 06.97	3				
G 340ti.40	10.92 - 06.97	MIDR062045E		3400 117 202 ⊕ 3482 083 044 ⊕ 1878 020 241 ⊕ 3100 008 106	430 20 MFZ430 430WGTZ KZISZ-5	Getr. / GBox: B9
				3400 093 031 ⊕ ⊕ 3488 017 334 ⊕ 1862 379 031	400 20 MFZ2/400X 400WGVZ	Getr. / GBox: B9/B18
				3400 700 329 ⊕ 3482 083 044 ⊕ 1878 022 841 ⊕ 3100 008 106	430 10 MFZ430 430GTZ KZISZ-5	Getr. / GBox: Fuller
Messenger		05.92 - 06.99				
B 80	01.92 -	SOFIM8140.07		1850 280 790 #	235 MF235	Getr. / GBox: ZF S5.18 Nur bei Altteil-Rückgabe lieferbar (Reparatur; Werk Bielefeld) / Please return old unit for repair (plant Bielefeld)
				1878 001 713	235 10 235VTB	Getr. / GBox: ZF S5.18
				3151 859 001	KZAS-0	Getr. / GBox: ZF S5.18

		CODE				
--	--	------	--	---	---	---























RENAULT TRUCKS

Messenger 05.92 - 06.99						
B 110	11.92 -	SOFIM8140.27		3499 373 055	250 MF250	->02.1993 Getr. / GBox: ZF S5.24
				1897 375 775	KZA-5	Getr. / GBox: ZF S5.24
B 120	11.92 - 02.93	SOFIM8140.47		3499 373 055	250 MF250	Getr. / GBox: ZF S5.24
				1897 375 775	KZA-5	Getr. / GBox: ZF S5.24

Midliner 09.83 - 01.00						
M 140.12/C	05.89 - 03.93	MIDS060212C		3400 117 301 # ⊗ 3482 008 033 ⊗ 1861 577 037 ⊙ 3151 199 001	310 10 MF310 310GTD KZIS-3	Getr. / GBox: ZF S 5-35
	05.89 - 03.93	MIDS060212		3400 700 339 ⊗ 3482 124 041 ⊗ 1878 001 729 ⊙ 3151 270 341	350 10 MF350 350GTD KZIS-3	Getr. / GBox: ZF S 6-36
M 140.13/C	05.89 - 03.93	MIDS060212		3400 700 339 ⊗ 3482 124 041 ⊗ 1878 001 729 ⊙ 3151 270 341	350 10 MF350 350GTD KZIS-3	Getr. / GBox: ZF S 6-36
M 140.13/C	04.89 - 03.93					
M 150.09/C	11.92 - 10.96	MIDS060226U		3400 700 339 ⊗ 3482 124 041 ⊗ 1878 001 729 ⊙ 3151 270 341	350 10 MF350 350GTD KZIS-3	Getr. / GBox: Fuller 4106A
M 150.09/C SP	11.92 - 10.96					
M 150.11/C	11.92 - 10.96					
M 150.11/C SP	11.92 - 10.96					
M 150.14/C CIT	11.92 - 10.96					
M 150.12/C	05.96 - 01.00	MIDS060226U		3400 700 338 ⊗ 3482 124 041 ⊗ 1878 001 145 ⊙ 3151 270 341	350 10 MF350 350WGTZ KZIS-3	Getr. / GBox: Fuller 4106A
M 150.14/C BOM	11.92 - 10.96					
M 150.12/C	11.92 - 10.96	MIDS060226U		3400 700 339 ⊗ 3482 124 041 ⊗ 1878 001 729 ⊙ 3151 270 341	350 10 MF350 350GTD KZIS-3	Getr. / GBox: Fuller 4106A Getr. / GBox: ZF S 6-36
M 150.12/C BTP	11.92 - 10.96					
M 150.13/C	11.92 - 10.96					
M 150.13/C BTP	11.92 - 10.96					
M 150.13/C	05.96 - 01.00	MIDS060226U		3400 700 338 ⊗ 3482 124 041 ⊗ 1878 001 145 ⊙ 3151 270 341	350 10 MF350 350WGTZ KZIS-3	Getr. / GBox: Fuller 4106A Getr. / GBox: ZF S 6-36
M 160.12/C	05.89 - 03.93	MIDS060212		3400 700 339 ⊗ 3482 124 041 ⊗ 1878 001 729 ⊙ 3151 270 341	350 10 MF350 350GTD KZIS-3	Getr. / GBox: ZF S5-35 Getr. / GBox: ZF S6-36
M 160.12/C	05.89 - 03.93					
M 160.13/C	05.89 - 03.93					
M 160.13/C	05.89 - 03.93	MIDS060212B		3482 124 041	350 MF350	Getr. / GBox: G406/409
M 160.13/C	05.89 - 03.93					
M 160.14/C BOM	05.89 - 03.93			1878 001 079	350 10 350GTZ	Getr. / GBox: G406/409
M 160.14/C CIT	05.89 - 03.93					
M 160.15/D	05.89 - 03.93					
ME 160.13	05.89 - 03.93					
ME 160.15	05.89 - 03.93			3151 000 285	KZI-4	Getr. / GBox: G406/409



















		CODE				
--	--	------	--	---	---	---

RENAULT TRUCKS

Midliner		09.83 - 01.00			
M 180.10/C	11.92 - 10.96	MIDR06.02.26W	 3400 700 338	350 10	Getr. / GBox: Euro1/ZFS6-36
M 180.11/C	11.92 - 10.96	/41, MIDR06.02.26W	 3482 124 041	MF350	
M 180.11/C SP	11.92 - 10.96		 1878 001 145	350WGTZ	
M 180.12/C	11.92 - 10.96	MIDR06.02.26V/	 3151 270 341	KZIS-3	
M 180.12/C	05.96 - 01.00	41, MIDR06.02.26V			
M 180.12/C BTP	11.92 - 10.96				
M 180.13 SP	11.92 - 10.96				
M 180.13/C	11.92 - 10.96				
M 180.13/C	11.92 - 10.96				
M 180.13/C	11.92 - 10.96				
M 180.13/C	05.96 - 01.00				
M 180.13/C	05.96 - 01.00				
M 180.13/C BTP	11.92 - 10.96				
M 180.15/D	11.92 - 10.96				
M 180.15/D	11.92 - 10.96				
M 180.15/D	11.92 - 10.96				
M 180.15/D	10.96 - 01.00				
M 180.15/D BTP	11.92 - 10.96				
M 180.16/D	11.92 - 10.96				
M 180.16/D	05.96 - 01.00				
M 210.12/C	05.92 - 01.00				
M 210.13/C	05.92 - 01.00				
M 210.15/D	05.92 - 01.00				
M 210.16/D	05.92 - 01.00				
M 200.10/C	05.88 - 03.93	MIDR060226	 3400 700 339	350 10	Getr. / GBox: ZF
M 200.12/C	05.88 - 03.93		 3482 124 041	MF350	Getr. / GBox: RVIG406
M 200.13/C	05.88 - 03.93		 1878 001 729	350GTD	
M 200.13/C	05.88 - 03.93	MIDR060226H	 3151 270 341	KZIS-3	
M 200.13/C	05.88 - 03.93		 3482 124 041	350	Getr. / GBox: G406/409
M 200.14/C BOM	05.88 - 03.93			MF350	
M 200.14/C CIT	05.88 - 03.93		 1878 002 075 #	350 16	Getr. / GBox: G406/409
M 200.15/D	05.88 - 03.93			350GTZ	
M 200.15/D	05.88 - 03.93		 3151 000 285	KZI-4	Getr. / GBox: G406/409
M 200.15/D	05.88 - 03.93				
M 200.15/D	05.88 - 03.93				
M 200.16/D	05.88 - 03.93				
M 200.16/D	05.88 - 03.93				
M 210.13/C	05.92 - 01.00	MIDR060226W	 3482 124 041	350	Getr. / GBox: ZF S 6-36S
M 210.13/C SP	05.92 - 10.96			MF350	Getr. / GBox: Eaton 4106A
M 210.14/D	05.96 - 01.00		 3151 270 341	KZIS-3	Getr. / GBox: ZF S 6-36S
M 210.15/D CIT	05.92 - 10.96				Getr. / GBox: Eaton 4106A
M 210.16/D	05.92 - 01.00				
M 210.16/D	05.96 - 01.00				
M 210.16/D CIT	05.92 - 10.96				
M 210.14/C BOM	05.92 - 10.96	MIDR060226W	 3400 700 338	350 10	Getr. / GBox: Eaton 4106A
			 3482 124 041	MF350	
			 1878 001 145	350WGTZ	
			 3151 270 341	KZIS-3	
			 3482 124 041	350	Getr. / GBox: G406
				MF350	
			 1878 002 075 #	350 16	Getr. / GBox: G406
				350GTZ	
			 3151 000 285	KZI-4	Getr. / GBox: G406
M 230.10/C	05.89 - 07.92	MIDR060226D	 3482 037 141	380	Getr. / GBox: G406-1
				GM380	40ACC4
			 3151 000 285	KZI-4	Getr. / GBox: G406-1
					40ACC4

		CODE				
--	--	------	--	---	---	---











































RENAULT TRUCKS

Midliner		09.83 - 01.00					
M 230.12/C	05.92 - 10.96	MIDR06.02.26D, MIDR06.02.26X, MIDR06.02.26S		3482 000 270 #	380		
M 230.12/D	05.89 - 07.92					GM380	
M 230.12/D	05.89 - 07.92				3151 000 285	KZI-4	
M 230.13/C	05.92 - 10.96						
M 230.13/C, M 230.13/D	05.89 - 10.96						
M 230.13/D	05.89 - 07.92						
M 230.13C/T	05.89 - 10.96						
M 230.15/D	05.89 - 10.96						
M 230.16/D	05.89 - 10.96						
M 230.16/D	05.89 - 10.96						
M 230.16/D CIT	05.89 - 07.92						
M 230.16D/T	05.89 - 10.96						
M 230.15/D	05.89 - 10.96		MIDR060226D		3482 037 141	380	Getr. / GBox: G409 40ACD1
M 230.15/D CIT	05.89 - 07.92				3151 000 285	KZI-4	Getr. / GBox: G409 40ACD1
M 250.13/C	05.96 - 01.00	MIDR06.02.26Y/ 41		3400 700 337	395 10		
M 250.13/C	05.96 - 01.00				 3482 115 031	MFZ395	
M 250.15/C, M 250.15/D	05.96 - 01.00				 1878 039 631	395GTZ	
M 250.15C/T	05.96 - 01.00				 3151 250 231	KZISZ-5	
M 250.16/D	05.96 - 01.00						
S 100.06/A	01.86 - 09.90	PerkinsT4-38		1898 917 116 ▲	280 10	Getr. / GBox: ZFS5-24	
S 100.06/A	01.86 - 09.90					280GSB	
S 100.07/A	01.86 - 09.90				1897 375 775	KZA-5	Getr. / GBox: ZFS5-24
S 100.07/A	01.86 - 09.90						
S 100.08/A	01.86 - 09.90						
S 100.08/A	01.86 - 09.90						
S 100.08/A	01.86 - 09.90						
S 100.08/A	01.86 - 09.90						
S 100.09/A CIT	01.86 - 09.90						
S 100.09/A BOM	01.86 - 09.90	T4.38		1897 375 775	KZA-5	Getr. / GBox: ZF S5-24	
S 110.06/A	06.85 - 09.90	797		1897 375 775	KZA-5	Getr. / GBox: ZFS5-24	
S 110.07/A	06.85 - 09.90						
S 110.08/A	06.85 - 09.90						
S 110.08/A	06.85 - 09.90						
S 110.08/A	06.85 - 09.90						
S 120.06/A	09.90 - 11.92	T4.40A/3, T4.40, T4.40CC		3482 092 031 <small>LHD</small>	280	Getr. / GBox: ZF S5-42	
S 120.06/A, S 120.07/A	09.90 - 11.92					MFZ280	
S 120.06/A, S 120.07/A	11.92 - 10.94				1878 001 727 <small>LHD</small>	280 10	Getr. / GBox: ZF S5-42
S 120.07/A	09.90 - 11.92					280WTB	
S 120.07/A	09.90 - 11.92				3151 600 544 <small>LHD</small>	KZISZ-3	Getr. / GBox: ZF S5-42
S 120.07/A	11.92 - 10.94				3400 700 449 <small>RHD</small>	310 10	Getr. / GBox: ZF S5-42
S 120.08/A	09.92 - 11.92				 3482 094 031	MFZ310	Nabenprofil / Hub Profile: 1 1/2"-10N
S 120.08/A	11.92 - 10.94				 1878 000 611	310TB	
S 120.08/A	11.92 - 10.94				 3151 600 544	KZISZ-3	
S 120.09/A	11.92 - 10.94						
S 120.09/A	11.92 - 10.94						
S 120.09/B	11.92 - 10.94						
S 120.09/B BOM	09.90 - 11.92						
S 120.09/B BOM	11.92 - 10.94						
S 120.09/B CIT	09.90 - 11.92						

(46)















		CODE				
--	--	------	--	---	---	---

RENAULT TRUCKS

Midliner		09.83 - 01.00					
S 120.07/A	09.90 - 11.92	T4.40	 3482 092 031 LHD	280			
				MFZ280			
			 1878 001 727 LHD	280 10			
				280WTB			
			 3151 600 544 LHD	KZISZ-3			
			 3400 700 449 RHD	310 10	01.1992->		
			 3482 094 031	MFZ310	Nabenprofil / Hub Profile: 1 1/2"-10N	(46)	
			 1878 000 611	310TB			
			 3151 600 544	KZISZ-3			
			 3400 700 339	350 10	Getr. / GBox: ZFS5-42		
			 3482 124 041	MF350			
			 1878 001 729	350GTD			
			 3151 270 341	KZIS-3			
S 120.08/A S 120.08/A S 120.08/A	09.90 - 11.92	T4.40	 3482 092 031 LHD	280	Getr. / GBox: ZF S5-42		
				MFZ280			
			 1878 001 727 LHD	280 10	Getr. / GBox: ZF S5-42		
				280WTB			
			 3151 600 544 LHD	KZISZ-3	Getr. / GBox: ZF S5-42		
			 3400 700 449 RHD	310 10	01.1992->		
			 3482 094 031	MFZ310	Getr. / GBox: ZF S5-42		
			 1878 000 611	310TB	Nabenprofil / Hub Profile: 1 1/2"-10N	(46)	
			 3151 600 544	KZISZ-3			
			 3400 117 301 #	310 10	Getr. / GBox: ZFS5-35		
			 3482 008 033	MF310	Nur zusammen verbauen / Only install together	(51)	
			 1861 577 037	310GTD			
S 130.06 S 130.07 S 130.08/A S 130.08/A,S 130.08/B S 130.08/A,S 130.08/B S 130.08/B S 130.08/R S 130.09/B S 130.09/B S 130.09/B S 130.11 S 130.11/B S 130.11/B S 130.13/B	09.83 - 01.90	797	 3151 199 001	KZIS-3			
			 3400 700 339	350 10	Getr. / GBox: ZFS6-36		
			 3482 124 041	MF350			
			 1878 001 729	350GTD			
			 3151 270 341	KZIS-3			
			 3482 124 041	350	Getr. / GBox: ZFS6-65		
				MF350			
S 135.08/A S 135.08/A	02.94 - 05.96	T4.40B/3	 3400 700 449 RHD	310 10	Nabenprofil / Hub Profile: 1 1/2"-10N	(46)	
			 3482 094 031	MFZ310			
			 1878 000 611	310TB			
			 3151 600 544	KZISZ-3			
			 1878 001 145 RHD	350 10	04.1996->		
				350WGTZ			
			 3151 600 544 RHD	KZISZ-3	04.1996->		
S 135.08/A,S 150.08/A S 135.08/A,S 150.08/A S 135.09/B,S 150.09/B	05.96 - 01.00	MIDR04.02.26A/41, MIDR04.02.26B/41	 3400 700 449 RHD	310 10	Nabenprofil / Hub Profile: 1 1/2"-10N	(46)	
			 3482 094 031	MFZ310			
			 1878 000 611	310TB			
			 3151 600 544	KZISZ-3			
			 1878 001 145 RHD	350 10			
				350WGTZ			
			 3151 600 544 RHD	KZISZ-3			
S 140.07/A S 140.07/A S 140.08/A,S 140.08/B S 140.08/A,S 140.08/B S 140.08/B S 140.09/B S 140.09/B S 140.09/B S 140.09/B	01.90 - 09.93	MIDS060212C	 3400 117 301 #	310 10	Getr. / GBox: ZF5-35/6-36		
			 3482 008 033	MF310			
			 1861 577 037	310GTD			
			 3151 199 001	KZIS-3			













		CODE				
--	--	------	--	---	---	---









RENAULT TRUCKS

Midliner		09.83 - 01.00			
S 150.08/A	05.96-01.00	MIDR060226U	 3400 700 339 ⊗ 3482 124 041 ⊗ 1878 001 729 ⊙ 3151 270 341	350 10 MF350 350GTD KZIS-3	Getr. / GBox: Eaton 4106B
S 150.08/A	11.92-01.94				
S 150.08/A	05.96-01.00				
S 150.08/A,S 150.08/B	11.92-01.94				
S 150.08/B	11.92-01.94				
S 150.09/B	05.96-01.00				
S 150.09/B	11.92-01.94				
S 150.09/B	05.96-01.00				
S 150.09/B	11.92-01.94				
S 150.08/A,S 150.08/B	01.94-05.96	MIDS06.02.12B, MIDS06.02.12D/ 3	 3400 700 339 ⊗ 3482 124 041 ⊗ 1878 001 729 ⊙ 3151 270 341	350 10 MF350 350GTD KZIS-3	Getr. / GBox: ZFS5-42
S 150.08/B	01.94-05.96				
S 150.08TI	05.86-09.90				
S 150.08TI	05.86-09.90				
S 150.09/B	01.94-05.96				
S 150.09TI	05.86-09.90				
S 150.09TI	05.86-09.90				
S 150.09TI	05.86-09.90				
S 150.09TI	05.86-09.90				
S 150.11TI	05.86-09.90				
S 150.11TI	05.86-09.90				
S 150.11TI	05.86-09.90				
S 150.13TI	05.86-09.90				
S 150.13TI	05.86-09.90				
S 150.13TI	04.86-09.90				
S 150.14TI BOM	05.86-09.90				
S 150.08TI	05.83-07.86	798-10	 3400 700 339 ⊗ 3482 124 041 ⊗ 1878 001 729 ⊙ 3151 270 341	350 10 MF350 350GTD KZIS-3	Getr. / GBox: ZFS5-35 Getr. / GBox: ZFS6-36
S 150.08TI	05.83-07.86				
S 150.09TI	05.83-07.86				
S 150.09TI	05.83-07.86		 3482 124 041	350 MF350	Getr. / GBox: ZFS6-65
S 150.08TI/R	05.86-09.90	MIDS06.02.12B, MIDS06.02.12D/ 3	 3400 700 339 ⊗ 3482 124 041 ⊗ 1878 001 729 ⊙ 3151 270 341	350 10 MF350 350GTD KZIS-3	Getr. / GBox: ZFS5-35 Getr. / GBox: ZFS6-36
S 150.09/B	01.94-05.96				
S 150.09/B,S 135.09/B	05.96-01.00	MIDR04.02.26A/ 41, MIDR04.02.26B/ 41	 1878 001 145	350 10 350WGTZ	Getr. / GBox: ZF S5-42 Getr. / GBox: Eaton 4106A
			 3151 600 544	KZISZ-3	Getr. / GBox: ZF S5-42 Getr. / GBox: Eaton 4106A
S 160.08/A,S 160.08/B	01.90-09.93	MIDS060212B	 3400 700 339 ⊗ 3482 124 041 ⊗ 1878 001 729 ⊙ 3151 270 341	350 10 MF350 350GTD KZIS-3	Getr. / GBox: ZFS5-35
S 160.08/B	01.90-09.93				
S 160.09/B	01.90-09.93				
S 160.09/B	01.90-09.93				
S 160.09/B SP	01.90-09.93				
S 170.11TI	10.87-05.89	MIDR060212	 3400 700 339 ⊗ 3482 124 041 ⊗ 1878 001 729 ⊙ 3151 270 341	350 10 MF350 350GTD KZIS-3	Getr. / GBox: ZFS5-35 Getr. / GBox: ZFS6-65
S 170.11TI/R	10.87-05.89				
S 170.11TI/R	10.87-05.89				
S 170.13TI	10.83-03.93		 3482 124 041	350 MF350	Getr. / GBox: BDSL
S 170.13TI,S 170 SP	10.83-03.93				
S 170.13TI,S 170.13TI/R	10.83-05.89		 1878 002 075 #	350 16 350GTZ	Getr. / GBox: BDSL
S 170.13TI/T	10.84-05.89				
S 170.14TI	10.83-05.89		 3151 000 285	KZI-4	Getr. / GBox: BDSL
S 170.14TI	10.83-05.89	798	 3482 124 041	350 MF350	Getr. / GBox: ZFS6-65
S 170.14TI/R	10.87-05.89				
S 170.15TI	10.82-09.93				
S 180.08/A	11.92-10.96	MIDR060226V	 3400 700 339 ⊗ 3482 124 041 ⊗ 1878 001 729 ⊙ 3151 270 341	350 10 MF350 350GTD KZIS-3	Getr. / GBox: Eaton 4106A
S 180.08/A	05.96-01.00				
S 180.08/A	05.96-01.00				
S 180.08/A,S 180.08/B	11.92-10.96				

		CODE				
--	--	------	--	---	---	---



RENAULT TRUCKS

Midliner		09.83 - 01.00					
S 180.08/A, S 180.08/B	11.92 - 10.96	MIDR06.02.26V/41,	 3400 700 339  3482 124 041  1878 001 729  3151 270 341	350 10 MF350 350GTD KZIS-3			
S 180.09/B	11.92 - 10.96	MIDR06.02.26V					
S 180.09/B	11.92 - 10.96						
S 180.09/B	11.92 - 10.96						
S 180.09/B	11.92 - 10.96						
S 180.09/B	05.96 - 01.00						
S 180.09/B	05.96 - 01.00						
S 220.11TI	09.87 - 09.90	MIDR060226	 3482 037 141	380 GM380			
S 220.11TI	09.87 - 09.90				 1897 376 506	KZA-4,5	
S 220.13TI	09.87 - 09.90						
S 220.13TI/T	09.87 - 09.90						
S 220.14TI	09.87 - 09.90						
S 220.14TI	09.87 - 09.90						
S 220.14TI	09.87 - 09.90						
S 220.14TI/T	09.87 - 09.90						
S 90		T4.38	 1897 375 775	KZA-5	Getr. / GBox: ZF S5-24		
S 90 09 BOM		720			 3499 373 055	250	Getr. / GBox: ZF S5-24
					 1897 375 775	KZA-5	Getr. / GBox: ZF S5-24
					 3499 373 055	250	Getr. / GBox: RVI 321+U407
					 1862 353 041 ▲	250 10	Getr. / GBox: RVI 321+U407
					 1897 375 775	250CB	Getr. / GBox: RVI 321+U407









Midlum		01.00 -						
135.08/B, 150.08/B	01.00 -	MIDR04.02.26B/4,	 3400 700 449	310 10 MFZ310 310TB KZISZ-3	für / for: Midlum 135	(68)		
135.08/B, 150.08/B	01.00 -	MIDR04.02.26A/4			 3482 094 031  1878 000 611  3151 600 544		Getr. / GBox: ZF S5.42	
135.09/B, 150.09/B	01.00 -						Getr. / GBox: Eaton 8209	
135.10/B, 150.10/B	01.00 -						Nabenprofil / Hub Profile: 1 1/2" -10N	(46)
135.10/B, 150.10/B	01.00 -							
150.08/B	10.01 -	MIDR04.02.26B/4, dCi4B, dCi4C	 3400 700 482	362 10	Getr. / GBox: ZF 5S-42	(46)		
150.10/B	10.01 -							Getr. / GBox: Eaton 4106A/B
150.12/B	01.00 -							Nabenprofil / Hub Profile: 1 1/2" -10N
180.08/B	10.01 -							
180.10/B	10.01 -							
180.12	10.01 -	dci6W, dCi4C	 3400 700 482	362 10	Getr. / GBox: ZF 5S-42	(46)		
220.12	10.01 -							Getr. / GBox: Eaton 5206A
220.14	10.01 -							Nabenprofil / Hub Profile: 1 1/2" -10N
220.15	10.01 -							
220.16	10.01 -							
220.18/D	10.01 -							
180.12/B, 180.12/C	10.01 -	dci6A, dci6W, dCi4C,	 3400 700 482	362 10	Getr. / GBox: ZF 5S-42	(46)		
210.12/C	01.00 -	MIDR06.02.26W/4						Getr. / GBox: Eaton 4106A/B
210.12/C, 220.12/C	01.00 -							Getr. / GBox: Eaton 4106 OD/5206A
210.13/C	01.00 -							Nabenprofil / Hub Profile: 1 1/2" -10N
210.13/C, 220.13/C, 220.13/D	01.00 -							
210.14/C, 220.14/C, 220.14/D	01.00 -							
210.15/C	01.00 -							
210.15/C	01.00 -							
210.16/C, 220.16/C, 22.16/D	01.00 -							
270.12/C	10.01 -							
270.13/C, 270.13/D	10.01 -							
270.14/C, 270.14/D	10.01 -							
270.16/C, 270.16/D	10.01 -							
210.08/B	01.00 -	dci6W, MIDR06.02.26W/4	 3400 700 482	362 10	Getr. / GBox: ZF 5S-42	(46)		
210.08/B, 220.08/B	01.00 -							Getr. / GBox: Eaton 4106 OD/5206A
					Nabenprofil / Hub Profile: 1 1/2" -10N			









		CODE				
--	--	------	--	---	---	---

RENAULT TRUCKS

Midlum		01.00 -					
210.09/B 210.10/B 210.10/B, 220.10/B 270.16/C 270.18/D	01.00- 01.00- 01.00- 10.01- 10.01-	dci6A, dci6W, MIDR06.02.2 6W/4		3400 700 482 LHD	362 10	Getr. / GBox: ZF 5S-42 Nabenprofil / Hub Profile: 1 1/2" -10N	(46)
240.12 240.13 240.14 240.15 240.16 240.18 280.12 280.13 280.14 280.16 280.18	05.06- 05.06- 05.06- 05.06- 05.06- 05.06- 05.06- 05.06- 05.06- 05.06- 05.06-	DXi7		3400 700 466 ⊗ 3482 634 003 ⊗ 1878 634 034 ⊙ 3151 000 752	395 10 MF395 395WGTZ KZIS-4	Getr. / GBox: ZF 9S1110TO Getr. / GBox: ZF 6S1000TO Getr. / GBox: ZF 6S850OD	



















P							
PX 28, 30		BM8.120		1864 497 042	430 20 430Z		

PR							
10 S (6G.)	12.78 -	MIDS062030		3482 037 141	380 GM380	Getr. / GBox: BDSL	
				1864 523 441	380 16 380Z	Getr. / GBox: BDSL	
12 S (6G.) 14 S	02.78 - 01.76 -			3482 037 141	380 GM380	Getr. / GBox: BDSL	
				1864 523 441	380 16 380Z	Getr. / GBox: BDSL	
14				3482 037 141	380 GM380	Getr. / GBox: BDSL	
				1864 523 441	380 16 380Z	Getr. / GBox: BDSL	
		MIDR062030		1897 376 506	KZA-4,5	Getr. / GBox: ZFS6-90	
14 SR	11.92 -	MIDR062030		1897 376 506	KZA-4,5	Getr. / GBox: ZFS6-80	

Premium		04.96 -					
Distribution 210.16	04.96 -	MIDR06.02.26W /4		1878 001 145	350 10 350WGTZ	Getr. / GBox: Eaton 4106 A	
				3151 600 544	KZISZ-3	Getr. / GBox: Eaton 4106 A	
				3400 700 337 ⊗ 3482 115 031 ⊗ 1878 039 631 ⊙ 3151 250 231	395 10 MFZ395 395GTZ KZISZ-5	Getr. / GBox: Eaton 8209 A	
Distribution 210.18D, 220.18	04.96 -	dci6W, MIDR06.02.2 6W/4		1878 001 145	350 10 350WGTZ	für / for: Premium 210 Getr. / GBox: Eaton 4106 A	(68)
				3151 600 544	KZISZ-3	für / for: Premium 210 Getr. / GBox: Eaton 4106 A	(68)
				3400 700 337 ⊗ 3482 115 031 ⊗ 1878 039 631 ⊙ 3151 250 231	395 10 MFZ395 395GTZ KZISZ-5	für / for: Premium 210 Getr. / GBox: Eaton 8209 A	(68)
Distribution 250.16 Distribution 250.18D Distribution 250.19	04.96 - 04.96 - 04.96 -	MIDR06.02.26Y/ 41		3400 700 337 ⊗ 3482 115 031 ⊗ 1878 039 631 ⊙ 3151 250 231	395 10 MFZ395 395GTZ KZISZ-5	Getr. / GBox: Eaton 8209 A	
Distribution 260 BOM Distribution 260.16 Distribution 260.18 Distribution 260.19	06.96 - 04.96 - 04.96 - 04.96 -	MIDR062045C/4		3400 700 409 ⊗ 3482 083 252 ⊗ 1878 026 241 ⊙ 3151 250 231	430 10 MFZ430 430WGTZ KZISZ-5	Getr. / GBox: Eaton 8209 A Getr. / GBox: ZF 9S-109 Getr. / GBox: ZF 16S-109	
Distribution 270.18	08.00 -	dci6A		3151 270 341	KZIS-3	für / for: MF 362	(68)



















		CODE				
--	--	------	--	---	---	---

RENAULT TRUCKS

Premium		04.96 -					
Distribution 300 BOM	06.96-	MIDR06.20.45D/ 41	 3400 123 401 ⊗ 3482 083 252 ⊗ 1878 020 241 ⊙ 3151 250 231	430 20 MFZ430 430WGTZ KZISZ-5	Getr. / GBox: B9		
Distribution 300.16D	04.96-						
Distribution 300.16T	04.96-						
Distribution 300.18D	04.96-			 3400 700 408 ⊗ 3482 083 252 ⊗ 1878 020 241 ⊙ 3151 000 404	430 20 MFZ430 430WGTZ KZISZ-5	Getr. / GBox: B9+35mm,B18 Getr. / GBox: B9 TBV	
Distribution 300.18D/T	04.96-						
Distribution 300.19	04.96-						
Distribution 300.19D/T	04.96-			 3400 117 532 ⊗ 3488 017 439 ⊗ 1862 379 031 ⊙ 3151 250 231	400 20 MFZ2/400X 400WGVZ KZISZ-5	Getr. / GBox: B9+35mm,B18 für Fahrzeuge mit Zweischeibenkupplung / for vehicles with double disc clutch (77) Je nach Kundenwunsch mit unterschiedlicher Kupplung / Equipped with different clutch according to customer requirement (33)	
Distribution 300.26D	04.96-						
Route 300.16	09.96-						
Route 300.18	09.96-						
Route 300.18T	09.96-		 3400 700 409 ⊗ 3482 083 252 ⊗ 1878 026 241 ⊙ 3151 250 231	430 10 MFZ430 430WGTZ KZISZ-5	Getr. / GBox: ZF 9S-109 Getr. / GBox: ZF 16S-109 Getr. / GBox: Eaton 8209 A		
Route 300.19	09.96-						
Route 300.19T	09.96-						
Distribution 320.18	08.00-	dCi11G	 3400 700 409 ⊗ 3482 083 252 ⊗ 1878 026 241 ⊙ 3151 250 231	430 10 MFZ430 430WGTZ KZISZ-5	Getr. / GBox: ZF 9S-109		
Distribution 320.18 D	08.00-						
Distribution 320.24D	08.00-			 3482 083 252	430 MFZ430	Getr. / GBox: ZF 12AS2301	
Distribution 320.26D	08.00-			 3151 000 144	KZISZ-5	Getr. / GBox: ZF 12AS2301	
Route 320.18	08.00-			 3400 700 311 ⊗ 3488 017 439 ⊗ 1862 379 032 ⊙ 3151 262 031	400 10 MFZ2/400X 400WGTZ KZISZ-5	Getr. / GBox: ZF 12AS2301 für Fahrzeuge mit Zweischeibenkupplung / for vehicles with double disc clutch (77)	
Route 320.18	08.00-						
Distribution 340.18D	04.96-	MIDR06.20.45E/ 41	 3400 123 401 ⊗ 3482 083 252 ⊗ 1878 020 241 ⊙ 3151 250 231	430 20 MFZ430 430WGTZ KZISZ-5	Getr. / GBox: B9		
Distribution 340.18D/T	04.96-						
Distribution 340.19D	04.96-			 3400 700 408 ⊗ 3482 083 252 ⊗ 1878 020 241 ⊙ 3151 000 404	430 20 MFZ430 430WGTZ KZISZ-5	Getr. / GBox: B18,B9+35mm Getr. / GBox: B9 TBV	
Distribution 340.19D/T	04.96-						
Distribution 340.26D	04.96-			 3400 117 532 ⊗ 3488 017 439 ⊗ 1862 379 031 ⊙ 3151 250 231	400 20 MFZ2/400X 400WGVZ KZISZ-5	Getr. / GBox: B18,B9+35mm für Fahrzeuge mit Zweischeibenkupplung / for vehicles with double disc clutch (77) Je nach Kundenwunsch mit unterschiedlicher Kupplung / Equipped with different clutch according to customer requirement (33)	
				 3400 700 409 ⊗ 3482 083 252 ⊗ 1878 026 241 ⊙ 3151 250 231	430 10 MFZ430 430WGTZ KZISZ-5	Getr. / GBox: ZF 9S-109 Getr. / GBox: ZF 16S-109	
				 3400 700 410 ⊗ 3482 083 252 ⊗ 1878 022 841 ⊙ 3151 274 131	430 10 MFZ430 430GTZ KZISZ-5	09.1999-> Getr. / GBox: ZF 8S-151 Getr. / GBox: ZF 16S-151	
				 3400 700 311 ⊗ 3488 017 439 ⊗ 1862 379 032 ⊙ 3151 262 031	400 10 MFZ2/400X 400WGTZ KZISZ-5	Getr. / GBox: ZF 8S-151 Getr. / GBox: ZF 16S-151 für Fahrzeuge mit Zweischeibenkupplung / for vehicles with double disc clutch (77)	
Distribution 370.18	08.00-	dCi11E, dCi11C, dCi11B/43	 3482 083 252	430 MFZ430	Getr. / GBox: ZF 8S-151 Getr. / GBox: ZF 16S-151 Getr. / GBox: ZF 16S-181 Getr. / GBox: ZF 12AS 2301 Getr. / GBox: ZF 12AS "Full Auto"		
Distribution 370.18D	08.00-						
Distribution 370.24D	08.00-			 3151 274 131	KZISZ-5	Getr. / GBox: ZF 8S-151 Getr. / GBox: ZF 16S-151 Getr. / GBox: ZF 16S-181 Getr. / GBox: ZF 12AS 2301	
Distribution 370.26D	08.00-			 3151 000 144	KZISZ-5	Getr. / GBox: ZF 12AS "Full Auto"	
Route 370.18	08.00-						
Route 370.18	08.00-						
Route 370.24	08.00-						
Route 370.26	08.00-						
Route 420.18	08.00-			 3400 700 311 ⊗ 3488 017 439 ⊗ 1862 379 032 ⊙ 3151 262 031	400 10 MFZ2/400X 400WGTZ KZISZ-5	für Fahrzeuge mit Zweischeibenkupplung / for vehicles with double disc clutch (77)	
Route 420.18T	08.00-						
Route 420.24	08.00-						
Route 420.24	08.00-						
Route 420.25	08.00-						
Route 420.26	08.00-						



















		CODE					
--	--	------	--	--	---	---	---

RENAULT TRUCKS

Premium		04.96 -					
Distribution 400.18D Distribution 400.18D/T	01.00-	MIDR06.23.56B/ 41		3400 700 401 ⊕ ⊗ 3483 034 035 ⊗ 1878 032 331	430 10 MFZ430 430WGTZ	Getr. / GBox: B9	
	01.00-			3400 700 408 ⊗ 3482 083 252 ⊗ 1878 020 241 ⊙ 3151 000 404	430 20 MFZ430 430WGTZ KZISZ-5	Getr. / GBox: B18 Getr. / GBox: B9 TBV	
				3400 117 532 ⊗ 3488 017 439 ⊗ 1862 379 031 ⊙ 3151 250 231	400 20 MFZ2/400X 400WGVZ KZISZ-5	Getr. / GBox: B9, B18 für Fahrzeuge mit Zweischeibenkupplung / for vehicles with double disc clutch	(77)
				3400 700 334 ⊗ 3482 083 252 ⊗ 1878 004 832 ⊙ 3151 274 131	430 10 MFZ430 430WGTZ KZISZ-5	Getr. / GBox: ZF 8S-151 Getr. / GBox: ZF 16S-151 Getr. / GBox: ZF 16S-181	
				3400 700 311 ⊗ 3488 017 439 ⊗ 1862 379 032 ⊙ 3151 262 031	400 10 MFZ2/400X 400WGTZ KZISZ-5	Getr. / GBox: ZF 8S-151 Getr. / GBox: ZF 16S-151 für Fahrzeuge mit Zweischeibenkupplung / for vehicles with double disc clutch	(77)
Distribution 420.18 Distribution 420.18D	08.00-	dCi11C		3400 700 334 ⊗ 3482 083 252 ⊗ 1878 004 832 ⊙ 3151 274 131	430 10 MFZ430 430WGTZ KZISZ-5	Getr. / GBox: ZF 8S-151 Getr. / GBox: ZF 16S-151 Getr. / GBox: ZF 16S-181 Getr. / GBox: ZF 12AS 2301	
	08.00-			3400 700 332 ⊗ 3482 083 252 ⊗ 1878 004 832 ⊙ 3151 000 144	430 10 MFZ430 430WGTZ KZISZ-5	Getr. / GBox: ZF 12AS "Full Auto"	
				3400 700 311 ⊗ 3488 017 439 ⊗ 1862 379 032 ⊙ 3151 262 031	400 10 MFZ2/400X 400WGTZ KZISZ-5	für Fahrzeuge mit Zweischeibenkupplung / for vehicles with double disc clutch	(77)
Route 340.18 Route 340.18T Route 340.19 Route 340.19T Route 340.24 Route 340.26	04.96-	MIDR06.20.45E/ 41		3400 123 401 ⊗ 3482 083 252 ⊗ 1878 020 241 ⊙ 3151 250 231	430 20 MFZ430 430WGTZ KZISZ-5	Getr. / GBox: B9	
	04.96-			3400 700 408 ⊗ 3482 083 252 ⊗ 1878 020 241 ⊙ 3151 000 404	430 20 MFZ430 430WGTZ KZISZ-5	Getr. / GBox: B9+35mm,B18 Getr. / GBox: B9 TBV	
	04.96-			3400 117 532 ⊗ 3488 017 439 ⊗ 1862 379 031 ⊙ 3151 250 231	400 20 MFZ2/400X 400WGVZ KZISZ-5	Getr. / GBox: B9+35mm,B18 für Fahrzeuge mit Zweischeibenkupplung / for vehicles with double disc clutch	(77)
	04.96-			3400 700 410 ⊗ 3482 083 252 ⊗ 1878 022 841 ⊙ 3151 274 131	430 10 MFZ430 430GTZ KZISZ-5	Getr. / GBox: ZF 8S-151 Getr. / GBox: ZF 16S-151	
	04.96-			3400 700 311 ⊗ 3488 017 439 ⊗ 1862 379 032 ⊙ 3151 262 031	400 10 MFZ2/400X 400WGTZ KZISZ-5	Getr. / GBox: ZF 8S-151 Getr. / GBox: ZF 16S-151 für Fahrzeuge mit Zweischeibenkupplung / for vehicles with double disc clutch	(77)
Route 385.18,400.18 Route 385.18T,400.18T Route 385.19,400.19 Route 385.19T,400.19T Route 385.24,400.24 Route 385.24T,400.24T Route 385.26 Route 385.26,400.26	04.96-	MIDR06.23.56B/ 41, MIDR06.23.56A/ 41		3400 123 401 ⊗ 3482 083 252 ⊗ 1878 020 241 ⊙ 3151 250 231	430 20 MFZ430 430WGTZ KZISZ-5	Getr. / GBox: B9	
	04.96-			3400 700 408 ⊗ 3482 083 252 ⊗ 1878 020 241 ⊙ 3151 000 404	430 20 MFZ430 430WGTZ KZISZ-5	Getr. / GBox: B9+35mm,B18	
	04.96-			3400 117 532 ⊗ 3488 017 439 ⊗ 1862 379 031 ⊙ 3151 250 231	400 20 MFZ2/400X 400WGVZ KZISZ-5	Getr. / GBox: B9+35mm,B18 für Fahrzeuge mit Zweischeibenkupplung / for vehicles with double disc clutch	(77)
	04.96-			3400 700 334 ⊗ 3482 083 252 ⊗ 1878 004 832 ⊙ 3151 274 131	430 10 MFZ430 430WGTZ KZISZ-5	Getr. / GBox: ZF 8S-151 Getr. / GBox: ZF 16S-151 Getr. / GBox: ZF 16S-181	
	09.96-			3400 700 311 ⊗ 3488 017 439 ⊗ 1862 379 032 ⊙ 3151 262 031	400 10 MFZ2/400X 400WGTZ KZISZ-5	Getr. / GBox: ZF 8S-151 Getr. / GBox: ZF 16S-151 für Fahrzeuge mit Zweischeibenkupplung / for vehicles with double disc clutch	(77)











		CODE					
--	--	------	--	--	---	---	---



RENAULT TRUCKS

Premium 2		10.05 -					
370 410		DXi7	 3400 700 479 ◐ ⊗ 3482 000 552 ⊗ 1878 006 584	430 24 MF430 430WGTZ	Getr. / GBox: AT2412D		
			 3400 710 060 ⊗ 3482 000 552 ⊗ 1878 003 867 ⚡ 6482 000 155	430 24 MF430 430WGTZ PHIS-6/38	Getr. / GBox: AT2412C/ATO2512C		
			 6482 000 155	PHIS-6/38	Getr. / GBox: AT2412D		
450		DXi7	 3400 710 061 ⊗ 3482 000 553 ⊗ 1878 006 129 ⚡ 6482 000 155	430 24 MF430 430WGTZ PHIS-6/38	Getr. / GBox: AT2412C/ATO2512C		
			 3400 700 479 ◐ ⊗ 3482 000 552 ⊗ 1878 006 584	430 24 MF430 430WGTZ	Getr. / GBox: AT2412D		
			 6482 000 155	PHIS-6/38	Getr. / GBox: AT2412D		
Distribution 240.18 D Distribution 270.19 Distribution 280.18 D Distribution 280.26 Distribution 310.18 Distribution 310.26 Distribution 320.18 D Distribution 320.26 Distribution 340.18 Distribution 340.26 Lander 270.18, Lander 270.19 Lander 310.19 Lander 310.26 Lander 340.18, Lander 340.19 Lander 340.26	05.06- 10.06- 10.05- 10.05- 10.06- 10.06- 10.05- 10.05- 10.06- 10.06- 10.06- 10.06- 10.06- 10.06- 10.06-	DXi7	 3400 700 466 ⊗ 3482 634 003 ⊗ 1878 634 034 ⦿ 3151 000 752	395 10 MF395 395WGTZ KZIS-4	Getr. / GBox: ZF 9S1110TO Getr. / GBox: ZF 6S1000TO		
			 3400 700 479 ◐ ⊗ 3482 000 552 ⊗ 1878 006 584	430 24 MF430 430WGTZ	Getr. / GBox: AT2412D		
			 6482 000 155	PHIS-6/38	Getr. / GBox: AT2412D		
Distribution 320.18 Distribution 340.19 Lander 310.26 Lander 340.26	05.06- 10.06- 10.06- 10.06-	DXi7	 3400 700 479 ◐ ⊗ 3482 000 552 ⊗ 1878 006 584	430 24 MF430 430WGTZ	Getr. / GBox: AT2412D		
			 6482 000 155	PHIS-6/38	Getr. / GBox: AT2412D		
Distribution 370.18 D Distribution 370.18 D Distribution 370.26 Distribution 410.18 D Distribution 410.18 D Distribution 410.26 Route 330.18 T Route 410.18 Route 410.24 Route 410.25 Route 410.25 Route 410.26	10.05- 10.05- 10.05- 10.05- 10.05- 10.05- 10.05- 10.05- 10.05- 10.05- 10.05- 10.05-	DXi11	 3400 700 399 ⊗ 3482 083 034 ⊗ 1878 004 832 ⦿ 3151 274 131	430 10 MFZ430 430WGTZ KZISZ-5	Getr. / GBox: 16S-2220		
			 3400 700 311 ⊗ 3488 017 439 ⊗ 1862 379 032 ⦿ 3151 262 031	400 10 MFZ2/400X 400WGTZ KZISZ-5	für Fahrzeuge mit Zweischeibenkupplung / for vehicles with double disc clutch	(77)	
			 3400 710 060 ⊗ 3482 000 552 ⊗ 1878 003 867 ⚡ 6482 000 155	430 24 MF430 430WGTZ PHIS-6/38	Getr. / GBox: AT2412		
Distribution 380.18 Distribution 380.19 Distribution 380.26 Lander 380.19 Lander 380.19 Lander 380.26 Lander 380.26 Lander 380.32 Route 380.18 Route 380.19 Route 380.26	10.06- 10.06- 10.06- 10.06- 10.06- 10.06- 10.06- 10.06- 10.06- 10.06- 10.06-	DXi11	 3400 700 399 ⊗ 3482 083 034 ⊗ 1878 004 832 ⦿ 3151 274 131	430 10 MFZ430 430WGTZ KZISZ-5	Getr. / GBox: 16S-2220		
			 3400 700 311 ⊗ 3488 017 439 ⊗ 1862 379 032 ⦿ 3151 262 031	400 10 MFZ2/400X 400WGTZ KZISZ-5	für Fahrzeuge mit Zweischeibenkupplung / for vehicles with double disc clutch	(77)	
			 3400 710 060 ⊗ 3482 000 552 ⊗ 1878 003 867 ⚡ 6482 000 155	430 24 MF430 430WGTZ PHIS-6/38	Getr. / GBox: AT2412		
			 3400 700 495 # ⊗ 3482 083 034 ⊗ 1878 004 832 ⦿ 3151 001 035	430 10 MFZ430 430WGTZ	Getr. / GBox: 16S1930		

		CODE					
--	--	------	--	--	---	---	---











RENAULT TRUCKS

Premium 2		10.05 -					
Distribution 430.18	10.06-	DXi11		3400 700 399 ⊗ 3482 083 034 ⊗ 1878 004 832 ⊙ 3151 274 131	430 10 MFZ430 430WGTZ KZISZ-5	Getr. / GBox: 16S-2220	
Distribution 430.19	10.06-			3400 700 311 ⊗ 3488 017 439 ⊗ 1862 379 032 ⊙ 3151 262 031	400 10 MFZ2/400X 400WGTZ KZISZ-5	für Fahrzeuge mit Zweischeibenkupplung / for vehicles with double disc clutch	(77)
Distribution 430.26	10.06-			3400 710 061 ⊗ 3482 000 553 ⊗ 1878 006 129 ⤵ 6482 000 155	430 24 MF430 430WGTZ PHIS-6/38	Getr. / GBox: AT 2412 C/ATO	
Distribution 460.19	10.06-			3400 700 438 ⊗ 3482 634 004 ⊗ 1878 003 968 ⊙ 3151 001 035	430 10 MFZ430 430WGTZ	Getr. / GBox: 16S-2230	
Distribution 460.19	10.06-						
Lander 430.32	10.06-						
Lander 460.18	10.06-						
Lander 460.18	10.06-						
Lander 460.26	10.06-						
Lander 460.26	10.06-						
Lander 460.32	10.06-						
Route 430.18	10.06-						
Route 430.19	10.06-						
Route 430.26	10.06-						
Route 430.26	10.06-						
Route 460.18	10.06-						
Route 460.18	10.06-						
Route 460.26	10.06-						
Route 460.26	10.06-						
Distribution 450.18 D	10.05-	DXi11		3400 700 399 ⊗ 3482 083 034 ⊗ 1878 004 832 ⊙ 3151 274 131	430 10 MFZ430 430WGTZ KZISZ-5	Getr. / GBox: 16S-2220	
Lander 440.18				3400 700 311 ⊗ 3488 017 439 ⊗ 1862 379 032 ⊙ 3151 262 031	400 10 MFZ2/400X 400WGTZ KZISZ-5	für Fahrzeuge mit Zweischeibenkupplung / for vehicles with double disc clutch	(77)
Lander 440.19				3400 710 061 ⊗ 3482 000 553 ⊗ 1878 006 129 ⤵ 6482 000 155	430 24 MF430 430WGTZ PHIS-6/38	Getr. / GBox: AT 2412 C/ATO	
Lander 440.26							
Route 410.18 D	10.05-						
Route 450.18	10.05-						
Route 450.18 D	10.05-						
Route 450.24	10.05-						
Route 450.25	10.05-						
Route 450.25	10.05-						
Route 450.26	10.05-						
Lander 430.18	10.06-	DXi11		3400 700 399 ⊗ 3482 083 034 ⊗ 1878 004 832 ⊙ 3151 274 131	430 10 MFZ430 430WGTZ KZISZ-5	Getr. / GBox: 16S-2220	
Lander 430.18	10.06-			3400 700 311 ⊗ 3488 017 439 ⊗ 1862 379 032 ⊙ 3151 262 031	400 10 MFZ2/400X 400WGTZ KZISZ-5	für Fahrzeuge mit Zweischeibenkupplung / for vehicles with double disc clutch	(77)
Lander 430.26	10.06-			3400 710 060 ⊗ 3482 000 552 ⊗ 1878 003 867 ⤵ 6482 000 155	430 24 MF430 430WGTZ PHIS-6/38	Getr. / GBox: AT2412	
Lander 430.26	10.06-			3400 700 438 ⊗ 3482 634 004 ⊗ 1878 003 968 ⊙ 3151 001 035	430 10 MFZ430 430WGTZ	Getr. / GBox: 16S-2230	
Lander 430.26	10.06-						

R		10.80 - 12.96					
R 310.16	10.80-03.89	MIDR063540		3400 116 601 ⊗ 3482 097 141 ⊗ 1878 020 241 ⊙ 3100 008 106	430 20 GMFZ430 430WGTZ KZISZ-5	Getr. / GBox: RVI	
R 310.16/T	10.80-03.89			3482 097 141	430 GMFZ430	->03.1986 Getr. / GBox: Fuller	
R 310.17	10.80-03.89			1878 022 841	430 10 430GTZ	->03.1986 Getr. / GBox: Fuller	
R 310.17/T	10.80-03.89						
R 310.19	10.80-03.89						
R 310.19/T	10.80-03.89						
R 310.22	10.80-03.89						
R 310.22	10.80-03.89						
R 310.22/T	10.80-03.89						









		CODE				
--	--	------	--	---	---	---









RENAULT TRUCKS



R		10.80 - 12.96					
R 330.17	05.88 - 05.91	MIDR062045		3400 116 601 ⊗ 3482 097 141 ⊗ 1878 020 241 ◊ 3100 008 106	430 20 GMFZ430 430WGTZ KZISZ-5	Getr. / GBox: RVI	
R 330.17/T	05.88 - 05.91						
R 330.19	05.88 - 05.91						
R 330.19/T	05.88 - 05.91						
R 330.24	05.88 - 05.91						
R 340.17	03.86 - 01.90	MIDR063540		3400 116 601 ⊗ 3482 097 141 ⊗ 1878 020 241 ◊ 3100 008 106	430 20 GMFZ430 430WGTZ KZISZ-5	Getr. / GBox: RVI	
R 340.17/T	03.86 - 01.90						
R 340.19	03.86 - 01.90						
R 340.19/T	03.86 - 01.90			3400 700 336 ⊗ 3482 097 141 ⊗ 1878 022 841 ◊ 3100 008 106	430 10 GMFZ430 430GTZ KZISZ-5	Getr. / GBox: Fuller	
R 340.24	03.86 - 01.90						
R 340.24	03.86 - 01.90						
R 340.ti	01.93 -	MIDR06.20.45E,		3483 023 001 ⊕	445 GMFZ445W	für Fahrzeuge mit Wandlerschaltkupplung / for vehicles with converter and clutch unit	(76)
R 385.ti	01.93 -	MIDR06.35.40L					
R 420.ti	01.93 -	1, MIDR06.35.40J/ 3		1878 051 801	445 24 445GTZC	für Fahrzeuge mit Wandlerschaltkupplung / for vehicles with converter and clutch unit	(76)
R 340ti.16/T	01.90 - 05.91	MIDR062045E		3400 116 601 ⊗ 3482 097 141 ⊗ 1878 020 241 ◊ 3100 008 106	430 20 GMFZ430 430WGTZ KZISZ-5	Getr. / GBox: B9/B18	
R 340ti.17	01.90 - 05.91						
R 340ti.18	01.90 - 05.91						
R 340ti.18	01.90 - 05.91			3400 123 201 ▲ ⊗ 3482 123 441 ⊗ 1878 022 841 ◊ 3100 008 106	430 10 GMFZ430 430GTZ KZISZ-5	Getr. / GBox: Fuller	
R 340ti.18	01.90 - 05.91						
R 340ti.18/T	01.90 - 05.91						
R 340ti.19	01.90 - 05.91						
R 340ti.19/T	01.90 - 05.91						
R 340ti.24	01.90 - 05.91						
R 340ti.26	01.90 - 05.91						
R 350.17	01.90 - 05.91	MIDR063540G		3400 116 601 ⊗ 3482 097 141 ⊗ 1878 020 241 ◊ 3100 008 106	430 20 GMFZ430 430WGTZ KZISZ-5	Getr. / GBox: B9/B18	
R 350.17	01.90 - 05.91						
R 350.17/T	01.90 - 05.91						
R 350.18	01.90 - 05.91			3400 123 201 ▲ ⊗ 3482 123 441 ⊗ 1878 022 841 ◊ 3100 008 106	430 10 GMFZ430 430GTZ KZISZ-5	Getr. / GBox: Fuller	
R 350.18	01.90 - 05.91						
R 350.18	01.90 - 05.91						
R 350.18/T	01.90 - 05.91						
R 350.19	01.90 - 05.91						
R 350.19/T	01.90 - 05.91						
R 350.19/TB	01.90 - 05.91						
R 350.24	01.90 - 05.91						
R 350.26	01.90 - 05.91						
R 365.17	10.87 - 05.90						
R 365.17/T	10.87 - 05.90						
R 365.19	10.87 - 05.90						
R 365.19/T	10.87 - 05.90						
R 365.24	10.87 - 05.90						
R 365.24	10.87 - 05.90						
R 370.16	10.83 - 07.85	MIVS083530		3400 116 601 ⊗ 3482 097 141 ⊗ 1878 020 241 ◊ 3100 008 106	430 20 GMFZ430 430WGTZ KZISZ-5	Getr. / GBox: B9/B18	
R 370.16/T	10.83 - 07.85						
R 370.22/T	10.83 - 07.85			3400 123 201 ▲ ⊗ 3482 123 441 ⊗ 1878 022 841 ◊ 3100 008 106	430 10 GMFZ430 430GTZ KZISZ-5	Getr. / GBox: Fuller	

		CODE				
--	--	------	--	---	---	---

RENAULT TRUCKS









R						
10.80 - 12.96						
R 380.17	01.90 - 05.91	MIDR063540H		3400 117 001 ⊗ 3482 123 441 ⊗ 1878 020 241 ⬤ 3100 008 106	430 20 GMFZ430 430WGTZ KZISZ-5	Getr. / GBox: B9/B18
R 380.18	01.90 - 05.91					
R 380.18	01.90 - 05.91					
R 380.18	01.90 - 05.91			3400 123 201 ▲ ⊗ 3482 123 441 ⊗ 1878 022 841 ⬤ 3100 008 106	430 10 GMFZ430 430GTZ KZISZ-5	Getr. / GBox: Fuller 14613
R 380.18/T	01.90 - 05.91					
R 380.19	01.90 - 05.91					
R 380.19/T	01.90 - 05.91					
R 380.19/TB	01.90 - 05.91					
R 380.22/T	01.90 - 05.91					
R 380.24	01.90 - 05.91					
R 380.25	01.90 - 05.91					
R 380.25	01.90 - 05.91					
R 380.25/T	01.90 - 05.91					
R 380.26	01.90 - 05.91					
R 380.26/T	01.90 - 05.91					
R 390.16	07.85 - 03.89	MIVR083530		3400 116 601 ⊗ 3482 097 141 ⊗ 1878 020 241 ⬤ 3100 008 106	430 20 GMFZ430 430WGTZ KZISZ-5	Getr. / GBox: B9/B18
R 390.16/T	07.85 - 03.89					
R 390.17	07.85 - 03.89					
R 390.17/T	07.85 - 03.89			3400 123 201 ▲ ⊗ 3482 123 441 ⊗ 1878 022 841 ⬤ 3100 008 106	430 10 GMFZ430 430GTZ KZISZ-5	Getr. / GBox: Fuller
R 390.22/T	07.85 - 03.89					
R 390.24	07.85 - 03.89					
R 390.24/T	07.85 - 03.89					
R 420.17	10.88 - 10.91	MIVR083530G		3400 116 601 ⊗ 3482 097 141 ⊗ 1878 020 241 ⬤ 3100 008 106	430 20 GMFZ430 430WGTZ KZISZ-5	Getr. / GBox: B9/B18
R 420.17/T	10.88 - 10.91					
R 420.19	10.88 - 10.91					
R 420.19/T	10.88 - 10.91			3400 700 336 ⊗ 3482 097 141 ⊗ 1878 022 841 ⬤ 3100 008 106	430 10 GMFZ430 430GTZ KZISZ-5	Getr. / GBox: ZF 16S-190
R 420.24	10.88 - 10.91					
R 420.24/T	10.88 - 10.91					
R 420.35/T	10.88 - 10.91	MIDR063540J		3400 117 001 ⊗ 3482 123 441 ⊗ 1878 020 241 ⬤ 3100 008 106	430 20 GMFZ430 430WGTZ KZISZ-5	Getr. / GBox: B9/B18
				3400 123 201 ▲ ⊗ 3482 123 441 ⊗ 1878 022 841 ⬤ 3100 008 106	430 10 GMFZ430 430GTZ KZISZ-5	Getr. / GBox: ZF 16S-190









S						
90	05.83 -	720		3499 373 055	250 MF250	Getr. / GBox: ZFS5-24 Getr. / GBox: 321
				1862 353 041 ▲	250 10 250CB	Getr. / GBox: 321
				1897 375 775	KZA-5	Getr. / GBox: ZFS5-24 Getr. / GBox: 321
90		PerkinsT4-38		1898 917 116 ▲	280 10 280GSB	Getr. / GBox: ZFS5-24
				1897 375 775	KZA-5	Getr. / GBox: ZFS5-24
SB 2 LE	10.70 - 12.79			3499 373 055	250 MF250	Getr. / GBox: 321 Benzin / Petrol (17)
				1862 353 041 ▲	250 10 250CB	Getr. / GBox: 321 Benzin / Petrol (17)
SB 2 MBD	- 12.79			3499 373 055	250 MF250	Getr. / GBox: 321 Diesel / Diesel (19)
				1862 353 041 ▲	250 10 250CB	Getr. / GBox: 321 Diesel / Diesel (19)













Saviem						
12. 215		MAN2156HM		1878 000 104 ●	380 10 380GTZ	
19. 215				3151 000 395	KZIS-4	
22. 215						

		CODE				
--	--	------	--	---	---	---

RENAULT TRUCKS





































Saviem						
12. 230 19. 230 22. 230 32. 230		MAN2356HM		1878 000 104 ●	380 10 380GTZ	
				3151 000 395	KZIS-4	
13. 168, HAB 15. 168, HAB 4x4 19. 192 H 17, 18, 19 B 19. 192 HA 17, 18, 19 B 19. 268	01.78 - 12.81 01.78 - 12.81 01.78 - 12.81 01.78 - 12.81 01.78 - 12.81			3482 002 234	350 GMF350X	
				1878 001 144	350 10 350WGTZ	
				1878 001 147 #	350 10 350WGTZ	
				3151 000 958	KZIS-4	
19. 240 H, HB, HAB, HA TB 26. 240 DHB 6x4 32. 240 DHB, DHAB, DHRB	01.74 - 12.81 01.75 - 12.81 01.75 - 12.81			1882 302 131	380 GF380	
				1878 001 152	380 10 380WGTZ	
				3151 000 395	KZIS-4	

SG						
2 3	01.69 - 01.79 01.74 - 01.79	712, 817		3499 373 055	250 MF250	Getr. / GBox: 321
				1862 353 041 ▲	250 10 250CB	Getr. / GBox: 321
SG 2 SG 3	02.79 - 02.79 -	712, 817		3499 373 055	250 MF250	Getr. / GBox: 321
				1862 353 041 ▲	250 10 250CB	Getr. / GBox: 321
				1897 375 775	KZA-5	Getr. / GBox: 321
SG 5	01.74 - 12.79			3499 373 055	250 MF250	Getr. / GBox: ZFS5-24
				1897 375 775	KZA-5	Getr. / GBox: ZFS5-24
SG 5 D	01.69 - 12.79			3499 373 055	250 MF250	Getr. / GBox: 321 Diesel / Diesel (19)
				1862 353 041 ▲	250 10 250CB	Getr. / GBox: 321 Diesel / Diesel (19)

SM						
10 , T 12 , T 15 .186	- 12.79 01.74 - 12.79			1882 110 532 #	350 GF350	
				1878 005 367	350 10 350WGTZ	
				3151 000 395	KZIS-4	
170	- 12.79			1882 110 532 #	350 GF350	Getr. / GBox: ZF
				1878 005 367	350 10 350WGTZ	Getr. / GBox: ZF
				3151 000 395	KZIS-4	Getr. / GBox: ZF
19 .240 (Sachs Version) 26 .240 (Sachs Version) 32 .240 6x6 (Sachs Version)	01.75 - 12.79 01.75 - 12.79 01.75 - 12.79	MAN2356		1882 302 131 HD	380 GF380	Getr. / GBox: 343.02
				3151 000 395	KZIS-4	Getr. / GBox: 343.02
19 .240 (Valeo Version) 21 .240 (Valeo Version) 26 .240 (Valeo Version) 260 32 .230 6x4, 6x6 32 .240 6x6 (Valeo Version)	01.75 - 12.79 01.74 - 12.79 01.75 - 12.79 11.77 - 12.79 01.75 - 12.79	MAN2356		3482 037 141	380 GM380	Getr. / GBox: 343.02
200	01.71 - 12.74	MAN2456		3482 037 141	380 GM380	Getr. / GBox: Saviem
21 .180	01.76 - 12.78			1882 110 532 #	350 GF350	
				1878 005 367	350 10 350WGTZ	



		CODE		 Parameter		
--	--	------	--	---	---	---



RENAULT TRUCKS





















SM									
21 .240 (Sachs Version)	01.74 - 12.79	MAN2356	 1882 302 131 HD	380 GF380	Getr. / GBox: 343.032				
			 3151 000 395	KZIS-4	Getr. / GBox: 343.032				
240	01.71 - 12.79	MAN2156	 3482 037 141	380 GM380	Getr. / GBox: Saviem				
240 (Sachs Version)	11.77 - 12.79	MAN2156	 1882 302 131 HD	380 GF380	Getr. / GBox: ZFAK6-80				
			 3151 000 395	KZIS-4	Getr. / GBox: ZFAK6-80				
240 (Valeo Version)	11.77 - 12.79	MAN2156	 3482 037 141	380 GM380	Getr. / GBox: ZFAK6-80				
240 HT	01.74 - 12.79		 3151 000 395	KZIS-4					
280	11.77 - 12.79	MAN2156	 3482 124 541	430 GMF430	Getr. / GBox: Fuller RTO 9509				
			 1882 330 032 ●#	420 GF420	Getr. / GBox: Fuller RTO 9509				
			 1878 001 136	420 10 420GTZ	Getr. / GBox: Fuller RTO 9509				
			 3151 000 395	KZIS-4	Getr. / GBox: Fuller RTO 9509				
		MAN2858	 3482 124 541	430 GMF430	Getr. / GBox: Fuller RTO 9509 Getr. / GBox: ZF				
			 1882 330 032 ●#	420 GF420	Getr. / GBox: Fuller RTO 9509 Getr. / GBox: ZF				
			 1878 001 155 ▲#	420 10 420WGTZ	Getr. / GBox: ZF				
			 1861 206 211 ●#	420 10 420GS	Getr. / GBox: ZF				
			 1878 001 136	420 10 420GTZ	Getr. / GBox: Fuller RTO 9509				
			 3151 000 395	KZIS-4	Getr. / GBox: Fuller RTO 9509 Getr. / GBox: ZF				
			300	11.77 - 12.79		 3482 124 541	430 GMF430	Getr. / GBox: Fuller RTO 9509	
						 1882 330 032 ●#	420 GF420	Getr. / GBox: Fuller RTO 9509	
 1878 001 136	420 10 420GTZ	Getr. / GBox: Fuller RTO 9509							
 3151 000 395	KZIS-4	Getr. / GBox: Fuller RTO 9509							
MAN2858	 3482 124 541	430 GMF430	Getr. / GBox: ZF						
	 1882 330 032 ●#	420 GF420	Getr. / GBox: ZF						
	 1878 001 155 ▲#	420 10 420WGTZ	Getr. / GBox: ZF						
	 1861 206 211 ●#	420 10 420GS	Getr. / GBox: ZF						
	 3151 000 395	KZIS-4	Getr. / GBox: ZF						
	32 .230 6x4, 6x6	01.74 - 12.79	MAN2858	 3151 000 395	KZIS-4	Getr. / GBox: 343.02			
32 .256 340 , T	01.76 - 12.77	MAN2858	 3482 124 541	430 GMF430	Getr. / GBox: ZF				
	01.74 - 12.79		 1882 330 032 ●#	420 GF420	Getr. / GBox: ZF				
			 1878 001 155 ▲#	420 10 420WGTZ	Getr. / GBox: ZF				
			 1861 206 211 ●#	420 10 420GS	Getr. / GBox: ZF				
			 3151 000 395	KZIS-4	Getr. / GBox: ZF				
32 .256 (Sachs Version)	01.76 - 12.77	MAN2858	 3482 124 541	430 GMF430	Getr. / GBox: Fuller				
			 1882 330 032 ●#	420 GF420	Getr. / GBox: Fuller				
			 1878 001 136	420 10 420GTZ	Getr. / GBox: Fuller				
			 3151 000 395	KZIS-4	Getr. / GBox: Fuller				







		CODE					
--	--	------	--	--	---	---	---

RENAULT TRUCKS

SM							
340, T				3482 124 541	430	Getr. / GBox: Fuller RTO	
				1882 330 032 ●#	420	Getr. / GBox: Fuller RTO	
				1878 001 136	420 10	Getr. / GBox: Fuller RTO	
				3151 000 395	KZIS-4	Getr. / GBox: Fuller RTO	

SP							
5	03.75 -			3499 373 055	250	Getr. / GBox: 321	
				1862 353 041 ▲	250 10	Getr. / GBox: 321	



T-Serie 01.13 -							
380P, 380P LOW	01.13-	DTI11		3400 700 600 ⊕	430 24	Getr. / GBox: MT 2214B / MT 2514B	(4)
380T, 380T LOW, 380T X-LOW	01.13-			3483 000 348	MFZ430	Getr. / GBox: MTO 2214B/MTO 2514B	
380P LOW	01.13-			1878 007 046		Abgasnorm: Euro 6 / Exhaust Emission Norm: Euro 6	
380T LOW, 380T TAG	01.13-			3400 710 064	430 24	Getr. / GBox: AT 2412/E /AT 2612/E	
380P, 380P LOW	01.13-			3482 001 169	MFZ430	Getr. / GBox: ATO 2612/E	(4)
380T PUS	01.13-			1878 007 170	430WGTZ	Abgasnorm: Euro 6 / Exhaust Emission Norm: Euro 6	
430P, 430P LOW	01.13-			6482 000 155	PHIS-6/38		
430P LOW	01.13-						
430P, 430P LOW	01.13-						
430T TAG, 430T LOW	01.13-						
430T PUS	01.13-						
460P, 460P LOW	01.13-						
460T, 460T LOW, 460T X-LOW	01.13-						
460P LOW	01.13-						
460P, 460P LOW	01.13-						
460T LOW, 460T TAG	01.13-						
460T PUS	01.13-						
440P, 440P LOW	01.13-	DTI13		3400 700 600 ⊕	430 24	Getr. / GBox: MT 2214B / MT 2514B	(4)
440T, 440T LOW, 440T X-LOW	01.13-			3483 000 348	MFZ430	Getr. / GBox: MTO 2214B/MTO 2514B	
440P LOW	01.13-			1878 007 046		Abgasnorm: Euro 6 / Exhaust Emission Norm: Euro 6	
440P, 440P LOW	01.13-			3400 710 064	430 24	Getr. / GBox: AT 2412/E /AT 2612/E	
440T LOW, 440T TAG	01.13-			3482 001 169	MFZ430	Getr. / GBox: ATO 2612/E	(4)
440T PUS	01.13-			1878 007 170	430WGTZ	Abgasnorm: Euro 6 / Exhaust Emission Norm: Euro 6	
480T, 480T LOW, 480T X-LOW	01.13-			6482 000 155	PHIS-6/38		
480P, 480P LOW	01.13-						
480P LOW	01.13-						
480T LOW, 480T TAG	01.13-						
480T PUS	01.13-						
520P, 520P LOW	01.13-	DTI13		3400 700 600 ⊕	430 24	Getr. / GBox: MTO 2514B	(4)
520T, 520T LOW, 520T X-LOW	01.13-			3483 000 348	MFZ430	Abgasnorm: Euro 6 / Exhaust Emission Norm: Euro 6	
520P LOW	01.13-			1878 007 046			
520T LOW, 520T TAG	01.13-			3400 710 064	430 24	Getr. / GBox: AT2612/E / ATO2612/E	
520T PUS	01.13-			3482 001 169	MFZ430	Abgasnorm: Euro 6 / Exhaust Emission Norm: Euro 6	(4)
	01.13-			1878 007 170	430WGTZ		
	01.13-			6482 000 155	PHIS-6/38		

TB							
191 A,B,C,E,F,G	10.78 - 10.81	MIDS062030		3482 037 141	380	Getr. / GBox: 6 G.	
				1864 523 441	380 16	Getr. / GBox: 6 G.	
191 B,C,E,F,G	11.81 -	MIDS062030		3482 037 141	380	Getr. / GBox: 10 G.	
				1864 523 441	380 16	Getr. / GBox: 10 G.	
				3151 000 285	KZI-4	Getr. / GBox: 10 G.	
231 A,B,C,E,F,G	10.78 - 10.81	MIDS062030		1864 497 043	430 16		



		CODE					
--	--	------	--	--	---	---	---



RENAULT TRUCKS











TB							
231 B,C,E,F,G	11.81 -	MIDS062030		1864 497 043	430 16	Getr. / GBox: 10 G.	
					430Z		
				1897 376 506	KZA-4,5	Getr. / GBox: 10 G.	

TBH							
260 6x4	01.78 -			1864 497 042	430 20	Getr. / GBox: BM8.120	
280 6x4	01.76 - 12.79				430Z		
280		MIDR063540		1882 022 101	420	Nebenantriebs-ID / PTO ID: 110	(48)
					G420XN		
				1878 634 014	420 10	Nebenantriebs-ID / PTO ID: 110	(48)
					420GSZ		

TF							
230 A, Turbo	10.77 - 12.79	MIDS062030		1864 497 043	430 16		
					430Z		





TL							
TLM 280	01.80 - 03.86	MIDS063540		1878 022 841	430 10	Getr. / GBox: Fuller RTO 9509	
					430GTZ		
TLM 280	01.80 -	MIDS063540		3400 116 801	430 20	Getr. / GBox: B9/B18	
				3482 097 141	GMFZ430		
				1878 027 442	430GTZ		
				3100 008 106	KZISZ-5		
TLR 280 , A TLR 280 , A1 TLR 280 C TLR 280 E	01.75 - 12.77	BM8.120		1864 497 042	430 20		
	10.77 - 12.82			430Z			
	01.75 - 12.82						
	01.74 - 12.83						









TP							
3 MB 35, 39 4x4	01.75 - 01.79			3499 373 055	250	Getr. / GBox: 321	
					MF250		
				1862 353 041 ▲	250 10	Getr. / GBox: 321	
					250CB		
3 MB 35, 39 4x4	02.79 - 12.83			3499 373 055	250	Getr. / GBox: 321	
					MF250		
				1862 353 041 ▲	250 10	Getr. / GBox: 321	
					250CB		
				1897 375 775	KZA-5	Getr. / GBox: 321	

















TR							
280 , A	01.74 - 12.84			1864 497 042	430 20	Getr. / GBox: BM8.120	
					430Z		
				1878 027 442	430 20	Getr. / GBox: B9.150	
					430GTZ		
305 A, Turbo 4x2	10.77 - 12.80	MIVS083530		1864 497 042	430 20	Getr. / GBox: BM8.120/3	
					430Z		
320 , A	01.74 - 12.78	MIV083530		1864 497 042	430 20	Getr. / GBox: BM8.120	
					430Z		
M 2000 M 2000 Militär / military	11.92 -			3499 373 055	250	Getr. / GBox: ZFS5-24	
					MF250		
		720		1897 375 775	KZA-5	Getr. / GBox: ZFS5-24	
				3499 373 055	250	Getr. / GBox: ZFS5-24	
					MF250		
				1897 375 775	KZA-5	Getr. / GBox: ZFS5-24	
M 10000	11.92 -	MIDS062045B		3482 083 044	430	Getr. / GBox: B18	
					MFZ430		
				1878 027 442	430 20	Getr. / GBox: B18	
					430GTZ		
				3100 008 204		Getr. / GBox: B18	(14)
				3151 234 231	KZISZ-5	Beinhaltet Ausrücker und Montagesatz / Contains releaser and fitting kit	
				3180 000 009			
M 10000	- 10.92	MIDS062045B		3400 116 801	430 20	Getr. / GBox: B9	
					GMFZ430		
					430GTZ		
					KZISZ-5		

		CODE				
--	--	------	--	---	---	---

RENAULT TRUCKS



TR						
M 10000 Militär / military		MIDR062045		3400 116 801  3482 097 141  1878 027 442  3100 008 106	430 20 GMFZ430 430GTZ KZISZ-5	Getr. / GBox: B9.150

85 - 90						
85.150 TI 4x4 (10G.)	10.85 -	MIDS060212B		3400 700 339  3482 124 041  1878 001 729  3151 270 341	350 10 MF350 350GTD KZIS-3	Getr. / GBox: ZFS5-35+BT232S
90 B (5G.)	01.78 - 12.80			3499 373 055	250 MF250	Getr. / GBox: ZF
				1897 375 775	KZA-5	Getr. / GBox: ZF
90 B 6	01.78 - 12.80			3499 373 055	250 MF250	Getr. / GBox: 321
				1862 353 041 ▲	250 10 250CB	Getr. / GBox: 321

100						
110.150 TI 4x4 (10G.)	10.85 -	MIDS060212B		3400 700 339  3482 124 041  1878 001 729  3151 270 341	350 10 MF350 350GTD KZIS-3	Getr. / GBox: ZF
110.170 4x4 (6G.)	09.85 -			3482 124 041	350 MF350	Getr. / GBox: ZF
				1864 351 005 ▲	350 10 350Z	Getr. / GBox: ZF
130 B (5G.)	01.78 - 12.80	797		3400 117 301 #  3482 008 033  1861 577 037  3151 199 001	310 10 MF310 310GTD KZIS-3	Getr. / GBox: ZF Nur zusammen verbauen / Only install together (51)
130 TB (6G.)	01.76 - 12.80	797		3482 124 041	350 MF350	Getr. / GBox: ZF S6-65
				1864 351 005 ▲	350 10 350Z	Getr. / GBox: ZF S6-65
150 B (5G.)	01.76 - 12.80	798		3400 700 339  3482 124 041  1878 001 729  3151 270 341	350 10 MF350 350GTD KZIS-3	Getr. / GBox: ZF

300						
380 K 4x4	01.73 - 12.81	Perkins4/236		3100 000 081	KZI-3	







400						
440 K	01.74 - 12.79	Perkins4/236		3100 000 081	KZI-3	



500						
500 K	01.72 - 12.79	Perkins4/236		3100 000 081	KZI-3	
550 K	01.72 - 12.79					
560 K	01.74 - 12.79					
560 K 6	01.77 - 12.79	MDO42030		3100 000 081	KZI-3	
560 KB						







600						
600 KB	01.74 - 12.75	MDO42030		3100 000 081	KZI-3	
610 K 6	01.77 - 12.79					
610 KB						
620 KB	01.76 - 12.79					
680 KB	01.74 - 12.75					

		CODE				
--	--	------	--	---	---	---

RENAULT TRUCKS

700						
700 KB	01.75 - 12.79	MDO42030		3100 000 081	KZI-3	
770 K. KB	01.73 - 12.75	MDO42030		3100 000 081	KZI-3	Getr. / GBox: BXSL 109
770 KB 6, SP		MIDO62030		3482 037 141	380 GM380	
				1864 523 441	380 16 380Z	
770 KB, KBK (5G.)	01.74 - 03.78	MD42030		1861 577 037 #	310 10 310GTD	Getr. / GBox: ZF S5-35
				3100 000 081	KZI-3	Getr. / GBox: ZF S5-35
770 KB, KBK (5G.)	04.78 - 12.79	MDO42030		1878 001 729	350 10 350GTD	Getr. / GBox: ZF

800						
880 KB	01.74 - 12.78	MDO42030		3100 000 081	KZI-3	Getr. / GBox: BXSL 109
880 KB (5G.)	04.78 -	MDO42030		1878 001 729	350 10 350GTD	Getr. / GBox: ZF
881 KB, KBD (5G.)	04.78 - 12.79	MDO42030		1861 577 037 #	310 10 310GTD	Getr. / GBox: ZF S5-35
881 KB, KBD (5G.)	- 03.78			3100 000 081	KZI-3	Getr. / GBox: ZF S5-35



900						
950 KB 6S, SA	01.78 - 12.79	MIDO62030		1864 497 043	430 16 430Z	Getr. / GBox: BDSL061
950 KBT 6S, SA, SB, SC, SE	01.78 - 12.79					
950 KB, KBT	- 12.79	MIDO62030		3482 037 141	380 GM380	
950 KB, KBT 6 (6G.)	01.76 - 12.79	MIDO62030		3482 037 141	380 GM380	
				1864 523 441	380 16 380Z	
950 KBT 6E	01.75 - 12.79	MIDO62030		3482 037 141	380 GM380	Getr. / GBox: BDSL061
				1864 523 441	380 16 380Z	Getr. / GBox: BDSL061
950, 951 KB (5G.)	01.73 - 12.79	MDO42030		1878 001 729	350 10 350GTD	Getr. / GBox: ZF

ROBUR

1800 - 3000						
1800				3151 870 001	KZA-3	
2002						
2500						
3000						

SCANIA



65						
CF 65		K422-1		1878 001 138	420 10 420GTZ	Mot. D11



75						
B 75		K422-1		1878 001 138	420 10 420GTZ	Mot. D11
CF 75						
L 75		K422-1		1878 001 138	420 10 420GTZ	Mot. DS10
LS 75						









76						
L 76		K422-1		1878 001 138	420 10 420GTZ	Mot. D11,DS11
LS 76						



		CODE					
--	--	------	--	--	---	---	---





SCANIA



80							
L 80 LB 80		K422-1		1878 001 138	420 10 420GTZ	Mot. D8,DS8	
		K422-3		3482 124 514	420 GMF430	Mot. D8,DS8	
				1878 001 138	420 10 420GTZ	Mot. D8,DS8	

81							
L 81 LB 81		K422-1		1878 001 138	420 10 420GTZ	Mot. D8,DS8 Getr. / GBox: G,GS760	
		K422-3		3482 124 514	420 GMF430	Mot. D8,DS8 Getr. / GBox: G,GS760/770	
				1878 003 238	420 22 420GTZ	Mot. D8,DS8 Getr. / GBox: G,GS770	

85							
L 85 LB 85		K422-1		1878 001 138	420 10 420GTZ	Mot. D8,DS8	
		K422-3		3482 124 514	420 GMF430	Mot. D8,DS8	
				1878 001 138	420 10 420GTZ	Mot. D8,DS8	
LBS 85		K422-3		3482 124 514	420 GMF430	Mot. D8,DS8	
				1878 001 138	420 10 420GTZ	Mot. D8,DS8	
LS 85		K422-3		3482 124 514	420 GMF430	Mot. D8,DS8	
				1878 001 138	420 10 420GTZ	Mot. D8,DS8	
		K422-1		1878 001 138	420 10 420GTZ	Mot. D8,DS8	

























86							
L 86 LB 86		K422-1		1878 001 138	420 10 420GTZ	Mot. D8,DS8 Getr. / GBox: G,GS760	
		K422-3		3482 124 514	420 GMF430	Mot. D8,DS8 Getr. / GBox: G,GS760/770	
				1878 003 238	420 22 420GTZ	Mot. D8,DS8 Getr. / GBox: G,GS770	















110							
L 110 LB 110 LBS 110 LBT 110 LS 110 LT 110		K422-1		1878 001 138	420 10 420GTZ	->12.1975 Mot. D,DS11	
		K422-4		3482 119 034	430 GMF430	01.1976-> Mot. DS11	
				3482 001 234 ●#	420 GMF420	01.1976-> Mot. DS11	
				1878 003 339	420 10 420GTZ	01.1976-> Mot. DS11	

111							
BF 111		K422-4		3482 119 034	430 GMF430	Mot. DS11 Getr. / GBox: G763	
				3482 001 234 ●#	420 GMF420	Mot. DS11 Getr. / GBox: G763	
				1878 003 339	420 10 420GTZ	Mot. DS11 Getr. / GBox: G763	

		CODE				
--	--	------	--	---	---	---

SCANIA

111						
L 111		K422-3	 3482 124 514	420 GMF430	Mot. D11 Getr. / GBox: G770,GR870	
			 1878 003 238	420 22 420GTZ	Mot. D11 Getr. / GBox: G770,GR870	
		K422-1	 1878 001 138	420 10 420GTZ	Mot. D11 Getr. / GBox: G760,GR860	
		K422-4, K422-9	 3482 001 234 ●#	420 GMF420	Mot. DS11 Getr. / GBox: G760,770/GR860,870	
			 3400 125 901 ◐  3482 119 034  1878 003 238	430 22 GMF430 420GTZ	Mot. DS11 Getr. / GBox: G760,770/GR860,870	
		K422-4	 1878 003 339	420 10 420GTZ	Mot. DS11 Getr. / GBox: G760,GR860	
LB 111		K422-9	 3400 125 901 ◐  3482 119 034  1878 003 238	430 22 GMF430 420GTZ	Mot. D11 Getr. / GBox: G770,GR870	
			 3482 124 514	420 GMF430	Mot. D11 Getr. / GBox: G770,GR870	
			 3482 001 234 ●#	420 GMF420	Mot. DS11 Getr. / GBox: G770,GR870	
			 1878 003 238	420 22 420GTZ	Mot. DS11 Getr. / GBox: G770,GR870	
		K422-4	 3482 119 034	430 GMF430	Mot. DS11 Getr. / GBox: G760,GR860	
			 3482 001 234 ●#	420 GMF420	Mot. DS11 Getr. / GBox: G760,GR860	
			 1878 003 339	420 10 420GTZ	Mot. DS11 Getr. / GBox: G760,GR860	
		K422-1	 1878 001 138	420 10 420GTZ	Mot. D11 Getr. / GBox: G760,GR860	
		LBS 111		K422-4	 3482 119 034	430 GMF430
 3482 001 234 ●#	420 GMF420				Mot. DS11 Getr. / GBox: G760,GR860	
 1878 003 339	420 10 420GTZ				Mot. DS11 Getr. / GBox: G760,GR860	
LS 111		K422-4	 3482 119 034	430 GMF430	Mot. DS11 Getr. / GBox: G760,GR860	
			 3482 001 234 ●#	420 GMF420	Mot. DS11 Getr. / GBox: G760,GR860	
			 1878 003 339	420 10 420GTZ	Mot. DS11 Getr. / GBox: G760,GR860	





































Serie 2 05.80 - 05.88						
82	10.82 - 03.88	K422-9	 3400 125 901 ◐  3482 119 034  1878 003 238	430 22 GMF430 420GTZ	Mot. DN8,DS8,11,DSC11,DS	
			 3482 001 234 ●#	420 GMF420	Mot. DN8,DS8,11,DSC11,DS	
92	01.85 - 12.88	K422-9	 3400 125 901 ◐  3482 119 034  1878 003 238	430 22 GMF430 420GTZ	Mot. DN8,DS8,11,DSC11,	
			 3482 001 234 ●#	420 GMF420	Mot. DN8,DS8,11,DSC11,	
		K422-8	 3483 019 031 #⊕	430 GMFZ430N	Mot. DN11,DS11 Getr. / GBox: GRE870 für Nebenantrieb / for PTO	(82)
112		K422-9	 3400 125 901 ◐  3482 119 034  1878 003 238	430 22 GMF430 420GTZ	Mot. DN8,DS8,11,DSC11,	
			 3482 001 234 ●#	420 GMF420	Mot. DN8,DS8,11,DSC11,	
112	01.81 - 12.86	K422-8	 3483 019 031 #⊕	430 GMFZ430N	Mot. DN11,DS11 Getr. / GBox: GRE870	
			 1878 003 365	420 22 420GTZ	Mot. DN11,DS11 Getr. / GBox: GRE870	



SCANIA

































Serie 2		05.80 - 05.88				
142	05.80 - 03.88	K384-4	3400 116 401 ⊖ 3482 033 401 3459 004 108 1861 799 133 x	380 22 GTF380 GTF2/380 380GSZ	->Chass. 4263275 Mot. DS,DSC14 Getr. / GBox: GR871	
			3488 009 634	380 GTF2/380	->Chass. 4263275 Mot. DS,DSC14 Getr. / GBox: GR871 enthält eine Kupplungsscheibe / This part number includes one clutch disc	(66)
			1861 799 133	380 22 380GSZ	->Chass. 4263275 Mot. DS,DSC14 Getr. / GBox: GR871 Lose Kupplungsscheibe / Loose clutch disc	(39)
		K384-8	3400 116 401 ⊖ 3482 033 401 3459 004 108 1861 799 133 x	380 22 GTF380 GTF2/380 380GSZ	->Chass. 4263275 Mot. DS,DSC14	
			3488 009 634	380 GTF2/380	->Chass. 4263275 Mot. DS,DSC14 enthält eine Kupplungsscheibe / This part number includes one clutch disc	(66)
			1861 799 133	380 22 380GSZ	->Chass. 4263275 Mot. DS,DSC14 Lose Kupplungsscheibe / Loose clutch disc	(39)
	K432-6	3400 123 901 ⊕ 3483 020 033 1878 062 944	430 22 MFZ430 430GTZ	Chass. 4263276-> Mot. DS,DSC14 Getr. / GBox: GR871/880		
		3482 083 039	430 MFZ430	Chass. 4263276-> Mot. DS,DSC14 Getr. / GBox: GR871/880 In 3483/3488 enthalten / Contained in 3483, 3488	(30)	
	K436-6	3400 123 901 ⊕ 3483 020 033 1878 062 944	430 22 MFZ430 430GTZ	Chass. 4263276-> Mot. DS,DSC14		
		3482 083 039	430 MFZ430	Chass. 4263276-> Mot. DS,DSC14 In 3483/3488 enthalten / Contained in 3483, 3488	(30)	

SCANIA

Serie 3		01.88 - 12.96				
93 113 143	01.88 - 12.96 01.88 - 12.96	K402-1	 3400 123 501 ⊕  3483 028 031  1862 450 031	400 22 MFZ400X 400GVZ		
			 3482 112 031	400 MFZ400X	In 3483/3488 enthalten / Contained in 3483, 3488	(30)
		K402-3	 3400 123 601 ⊕  3483 028 031  1878 043 231	400 24 MFZ400X 400WGVZ		
			 3482 112 031	400 MFZ400X	In 3483/3488 enthalten / Contained in 3483, 3488	(30)
		K402-4	 3483 024 031 ⊕	430 GMFZ430N	Nebenantriebs-ID / PTO ID: EK330/340/630/640	(48)
			 1878 043 231	400 24 400WGVZ	Nebenantriebs-ID / PTO ID: EK330/340/630/640	(48)
		K422-8	 3483 019 031 #⊕	430 GMFZ430N	Nebenantriebs-ID / PTO ID: EK422	(48)
			 1878 003 365	420 22 420GTZ	Nebenantriebs-ID / PTO ID: EK421/422	(48)
		K422-9	 3400 125 901 ⊖  3482 119 034  1878 003 238	430 22 GMF430 420GTZ		
			 3482 001 234 ●#	420 GMF420		
		K422-12	 3482 119 034	430 GMF430		
			 3482 001 234 ●#	420 GMF420		
			 1878 003 658	420 24 420WGTZ		
		K422-13	 3483 024 031 ⊕	430 GMFZ430N	Chass. 1196681 - Chass. 1217685 Nebenantriebs-ID / PTO ID: EK330	(48)
			 1878 003 658	420 24 420WGTZ	Chass. 1196681 - Chass. 1217685 Nebenantriebs-ID / PTO ID: EK330	(48)
		K432-3	 3482 119 034	430 GMF430	Nur zusammen verbauen / Only install together	(51)
			 3482 001 234 ●#	420 GMF420	Nur zusammen verbauen / Only install together	(51)
			 1862 328 031	420 22 420WGVZ	Nur zusammen verbauen / Only install together	(51)
		K432-5	 3400 123 801 ⊕  3483 020 036  1878 062 944	430 22 MFZ430 430GTZ		
			 3482 083 039	430 MFZ430	In 3483/3488 enthalten / Contained in 3483, 3488	(30)
		K432-6	 3400 123 901 ⊕  3483 020 033  1878 062 944	430 22 MFZ430 430GTZ		
			 3482 083 039	430 MFZ430	In 3483/3488 enthalten / Contained in 3483, 3488	(30)
		K432-10, K432-14, K432-7, K432-8	 3400 123 701 ⊕  3483 020 036  1878 003 066	430 24 MFZ430 430WGTZ		
			 3483 024 031 ⊕	430 GMFZ430N	Nebenantriebs-ID / PTO ID: EK300/310/330 Nebenantriebs-ID / PTO ID: EK340/630/640	(48) (48)
		K432-13	 1878 063 231 #	430 24 430WGTZ	Nebenantriebs-ID / PTO ID: EK300/310/330 Nebenantriebs-ID / PTO ID: EK340/630/640	(48) (48)





















































		CODE					
--	--	------	--	--	---	---	---

SCANIA

Serie 4		09.95 - 09.04					
94	09.95 - 09.04	K402-4		3483 024 031 ⊕	430 GMFZ430N	Nebenantriebs-ID / PTO ID: EK300/310/330 Nebenantriebs-ID / PTO ID: EK340/630/640	(48) (48)
114	09.95 - 09.04			1878 043 231	400 24 400WGVZ	Nebenantriebs-ID / PTO ID: EK300/310/330 Nebenantriebs-ID / PTO ID: EK340/630/640	(48) (48)
124	09.95 - 09.04						
144	09.95 - 09.04	K402-5		3400 700 323 ⊖ ⊕ 3482 112 031 ⊕ 1878 043 231 ⊙ 3180 007 000	400 24 MFZ400X 400WGVZ		
164	09.95 - 09.04			3182 009 938	HHISZ-4	Immer erneuern / Renew everytime	(28)
				3180 007 000		Immer erneuern / Renew everytime Montagesatz für Ausrücklager / Fitting kit for releaser	(28) (44)
		K432-13		3483 024 031 ⊕	430 GMFZ430N	Nebenantriebs-ID / PTO ID: EK300/310/330 Nebenantriebs-ID / PTO ID: EK340/630/640	(48) (48)
				1878 063 231 #	430 24 430WGTZ	Nebenantriebs-ID / PTO ID: EK300/310/330 Nebenantriebs-ID / PTO ID: EK340/630/640	(48) (48)
		K432-15		3482 083 039	430 MFZ430		
				1878 063 231 #	430 24 430WGTZ		
				3182 009 938	HHISZ-4	Immer erneuern / Renew everytime	(28)
				3180 007 000		Immer erneuern / Renew everytime Montagesatz für Ausrücklager / Fitting kit for releaser	(28) (44)
		K432-16		3400 122 001 ⊖ ⊕ 3482 083 150 ⊕ 1878 063 231	430 24 MFZ430 430WGTZ		
				3400 710 004 ⊕ 3482 083 150 ⊕ 1878 003 066 ⊙ 3182 009 938	430 24 MFZ430 430WGTZ HHISZ-4		
				3182 009 938	HHISZ-4	Immer erneuern / Renew everytime	(28)
				3180 007 000		Immer erneuern / Renew everytime Montagesatz für Ausrücklager / Fitting kit for releaser	(28) (44)
		K432-17		3482 083 039	430 MFZ430		
				1878 063 231 #	430 24 430WGTZ		
				3182 009 938	HHISZ-4	Immer erneuern / Renew everytime	(28)
				3180 007 000		Immer erneuern / Renew everytime Montagesatz für Ausrücklager / Fitting kit for releaser	(28) (44)
		K432-19		3400 700 324 ⊖ ⊕ 3482 124 731 ⊕ 1878 003 065	430 24 MFZ430 430WGTZ		
				3182 009 938	HHISZ-4	Immer erneuern / Renew everytime	(28)
				3180 007 000		Immer erneuern / Renew everytime Montagesatz für Ausrücklager / Fitting kit for releaser	(28) (44)
		K432-30		3482 000 251	430 MFZ430		
				1878 063 231 #	430 24 430WGTZ		
				3151 000 151	KZISZ-5		
		K432-31		3482 000 251	430 MFZ430		
				1878 063 231 #	430 24 430WGTZ		
				3151 000 151	KZISZ-5		
		K432-32		3482 000 251	430 MFZ430		
				1878 063 231 #	430 24 430WGTZ		
				3151 000 151	KZISZ-5		
		K432-33		3400 700 352 ⊕ 3482 000 257 ⊕ 1878 003 065 ⊙ 3151 000 151	430 24 MFZ430 430WGTZ KZISZ-5		
		K442-3		3182 009 938	HHISZ-4	Immer erneuern / Renew everytime	(28)













		CODE		 Parameter		
--	--	------	--	---	---	---

SCANIA







Serie P, G, R, T		03.04 -			
P, G, R, T - Serie	K432-20	 3400 700 371  3482 000 999  1878 003 839  3151 000 151	430 24 MFZ430 430WGTZ KZISZ-5		
	K432-25	 3483 000 259 ⊕	430 GMFZ430N	Nebenantriebs-ID / PTO ID: EK630,640	(48)
		 1878 003 839	430 24 430WGTZ	Nebenantriebs-ID / PTO ID: EK630,640	(48)
		 3100 005 202  3151 205 202  3180 001 008	KZIZ-5 KZIZ-5	Nebenantriebs-ID / PTO ID: EK630,640	(48)
	K432-26	 3400 700 374  3482 000 999  1878 003 895  3151 000 151	430 24 MFZ430 430WGTZ KZISZ-5		
	K432-27, K432-44	 3400 700 370  3482 000 999  1878 003 969  3151 000 151	430 24 MFZ430 430WGTZ KZISZ-5		
	K432-33, K432-35, K432-39	 3400 700 352  3482 000 257  1878 003 065  3151 000 151	430 24 MFZ430 430WGTZ KZISZ-5		
	K432-36, K432-37	 3400 700 372  3482 000 257  1878 003 839  3151 000 151	430 24 MFZ430 430WGTZ KZISZ-5		
	K432-38	 3400 700 373  3482 000 257  1878 003 969  3151 000 151	430 24 MFZ430 430WGTZ KZISZ-5		
	K432-40	 3482 000 589	430 GMFZ430N	Nebenantriebs-ID / PTO ID: EK730, 740	(48)
		 1878 003 969	430 24 430WGTZ	Nebenantriebs-ID / PTO ID: EK730, 740	(48)
		 3151 000 273	KZIZ-5	Nebenantriebs-ID / PTO ID: EK730, 740	(48)
	K432-41	 3482 000 589	430 GMFZ430N	Nebenantriebs-ID / PTO ID: EK730, 740	(48)
		 1878 003 839	430 24 430WGTZ	Nebenantriebs-ID / PTO ID: EK730, 740	(48)
		 3151 000 273	KZIZ-5	Nebenantriebs-ID / PTO ID: EK730, 740	(48)
	K432-42	 3482 000 589	430 GMFZ430N	Nebenantriebs-ID / PTO ID: EK730, 740	(48)
		 1878 003 895	430 24 430WGTZ	Nebenantriebs-ID / PTO ID: EK730, 740	(48)
		 3151 000 273	KZIZ-5	Nebenantriebs-ID / PTO ID: EK730, 740	(48)
	K432-45	 3482 000 589	430 GMFZ430N	Nebenantriebs-ID / PTO ID: EK730, 740	(48)
		 1878 006 854	430 24 430WGTZ	Nebenantriebs-ID / PTO ID: EK730, 740	(48)
	K432-46	 3483 000 259 ⊕	430 GMFZ430N	Nebenantriebs-ID / PTO ID: EK630, 640	(48)
		 1878 003 969	430 24 430WGTZ	Nebenantriebs-ID / PTO ID: EK630, 640	(48)
		 3100 005 202  3151 205 202  3180 001 008	KZIZ-5 KZIZ-5	Nebenantriebs-ID / PTO ID: EK630, 640	(48)
	K432-48	 3400 700 491  3482 000 999  1878 006 370  3151 000 151	430 24 MFZ430 430WGTZ KZISZ-5		
	K432-49	 3482 000 589	430 GMFZ430N	Nebenantriebs-ID / PTO ID: EK730, 740	(48)
		 3151 000 273	KZIZ-5	Nebenantriebs-ID / PTO ID: EK730, 740	(48)
	K432-54	 3482 000 257	430 MFZ430		



		CODE					
--	--	------	--	--	---	---	---



SCANIA



Serie P,G,R,T		03.04 -				
P, G, R, T - Serie	K432-55	 3482 000 257	430 MFZ430			
		 3151 000 151	KZISZ-5			
	K432-62	 3400 700 611	430 24 MFZ430 430WGTZ			
		 3482 000 999	430 GMFZ430N	für Nebenantrieb / for PTO	(82)	
		 1878 007 253	430 24 430WGTZ	für Nebenantrieb / for PTO	(82)	
		 3151 000 151	KZISZ-5	für Nebenantrieb / for PTO	(82)	
	 3482 000 589	430 GMFZ430N	für Nebenantrieb / for PTO	(82)		
	 1878 007 254	430 24 430WGTZ	für Nebenantrieb / for PTO	(82)		
	 3151 000 273	KZISZ-5	für Nebenantrieb / for PTO	(82)		
P 124/420 24T dump truck P 124/420 24T tractor		 1800 125 602	380 10 GF2/380 380GTZ			
		 1888 042 009				
		 1878 000 968				
		 3151 066 004				

SISU











E				
E 12	 3488 017 439	400 MFZ2/400X	enthält eine Kupplungsscheibe / This part number includes one clutch disc mit Zwischenring / with intermediate ring	(66)
	 1862 379 031	400 20 400WGVZ		(95)
E 12M	 3400 700 485 #	430 10 GMFZ430N 430WGTZ		
	 3482 123 631	KZIZ-6		
	 1878 004 832			
	 3151 263 031			

SK					
SK 171 SK 181	10.85-	 3482 021 031	380 GM380		
		 1861 902 032 #	380 10 380GTD		
		 3151 027 102	KZI4,5		



SL					
SL 171 SL 181	10.85-	 3482 021 031	380 GM380		
		 1861 902 032 #	380 10 380GTD		
		 3151 027 102	KZI4,5		

SM					
SM Serie	08.95-	CumminsN11, 14	 3482 000 209	430 MFZ430	
			 1878 054 933	430 10 430GTZ	
			 3151 000 034	KZISZ-5	











STEYR









6...					
6 S 10	D0824FL, LFL	 3400 700 322	330 10 MFZ330 330WTB	->03.1996 Je nach Kundenwunsch mit unterschiedlicher Kupplung / Equipped with different clutch according to customer requirement	(33)
		 3482 093 032			
		 1862 438 032			
		 3400 710 001	362 10 MFZ362 362GTZ		
		 3482 120 031	HHISZ-3		
		 1878 044 631			
		 3182 005 231			
		 3400 121 801	362 10 MFZ362 362GTZ		
		 3482 120 031			
		 1878 044 631			

STEYR

6...						
6 S 16	D0824LFL	 3400 700 322 ☾ ⊗ 3482 093 032 ⊗ 1862 438 032	330 10 MFZ330 330WTB	->03.1996 Je nach Kundenwunsch mit unterschiedlicher Kupplung / Equipped with different clutch according to customer requirement	(33)	
		 3400 710 001 ⊗ 3482 120 031 ⊗ 1878 044 631 ↘ 3182 005 231	362 10 MFZ362 362GTZ HHISZ-3			
		 3400 121 801 ☾ ⊗ 3482 120 031 ⊗ 1878 044 631	362 10 MFZ362 362GTZ			

























7...						
7 G 1 F-K 7 GA 1 F-K		 1882 325 134	380 G380			
		 3151 000 395	KZIS-4			

8...						
8 S 10	D0824FL, LFL	 3400 700 322 ☾ ⊗ 3482 093 032 ⊗ 1862 438 032	330 10 MFZ330 330WTB	->03.1996 Je nach Kundenwunsch mit unterschiedlicher Kupplung / Equipped with different clutch according to customer requirement	(33)	
		 3400 710 001 ⊗ 3482 120 031 ⊗ 1878 044 631 ↘ 3182 005 231	362 10 MFZ362 362GTZ HHISZ-3			
		 3400 121 801 ☾ ⊗ 3482 120 031 ⊗ 1878 044 631	362 10 MFZ362 362GTZ			
8 S 15 8 S 16	D0824LFL	 3400 700 322 ☾ ⊗ 3482 093 032 ⊗ 1862 438 032	330 10 MFZ330 330WTB	->03.1996 Je nach Kundenwunsch mit unterschiedlicher Kupplung / Equipped with different clutch according to customer requirement	(33)	
		 3400 710 001 ⊗ 3482 120 031 ⊗ 1878 044 631 ↘ 3182 005 231	362 10 MFZ362 362GTZ HHISZ-3			
		 3400 121 801 ☾ ⊗ 3482 120 031 ⊗ 1878 044 631	362 10 MFZ362 362GTZ			
8 S 18	WD612.63	 3151 156 003	KZIZ-4,5			
8 S 22	D0826LFL	 3400 125 501 ⊗ 3482 060 132 ⊗ 1878 001 077 ⊗ 3151 199 001	350 10 MF350 350GTZ KZIS-3	->02.1994		
		 3482 060 132	350 MF350	03.1994->		
		 1878 001 145	350 10 350WGTZ	03.1994->		
		 3151 199 001	KZIS-3	03.1994->		

9...						
9 G 4 F-K 9 GNFA-L		 1882 325 134	380 G380			
		 3151 000 395	KZIS-4			
9 S 14	WD612.24	 3482 063 101 #	310 MFZ310			
		 1862 125 202 #	310 10 310GTD			
		 3151 156 003	KZIZ-4,5			
9 S 15 9 S 16	D0824LFL	 3400 700 322 ☾ ⊗ 3482 093 032 ⊗ 1862 438 032	330 10 MFZ330 330WTB	->03.1996 Je nach Kundenwunsch mit unterschiedlicher Kupplung / Equipped with different clutch according to customer requirement	(33)	
		 3400 710 001 ⊗ 3482 120 031 ⊗ 1878 044 631 ↘ 3182 005 231	362 10 MFZ362 362GTZ HHISZ-3			
		 3400 121 801 ☾ ⊗ 3482 120 031 ⊗ 1878 044 631	362 10 MFZ362 362GTZ			































		CODE				
--	--	------	--	---	---	---



























STEYR



9...						
9 S 18		WD612.71, 73		1878 001 144	350 10 350WGTZ	
		WD612.63		3151 156 003	KZIZ-4,5	
9 S 22		D0826LFL		3400 125 501 ⊕ 3482 060 132 ⊕ 1878 001 077 ⊖ 3151 199 001	350 10 MF350 350GTZ KZIS-3	->02.1994
				3482 060 132	350 MF350	03.1994->
				1878 001 145	350 10 350WGTZ	03.1994->
				3151 199 001	KZIS-3	03.1994->
10...						
10 S 14		WD612.24		3482 063 101 #	310 MFZ310	
				1862 125 202 #	310 10 310GTD	
				3151 156 003	KZIZ-4,5	
10 S 15 10 S 16		D0824LFL		3400 700 322 ⊖ ⊕ 3482 093 032 ⊕ 1862 438 032	330 10 MFZ330 330WTB	->03.1996 Je nach Kundenwunsch mit unterschiedlicher Kupplung / Equipped with different clutch according to customer requirement (33)
			3400 710 001 ⊕ 3482 120 031 ⊕ 1878 044 631 ↗ 3182 005 231	362 10 MFZ362 362GTZ HHISZ-3		
			3400 121 801 ⊖ ⊕ 3482 120 031 ⊕ 1878 044 631	362 10 MFZ362 362GTZ		
10 S 18		WD612.71, 73		1878 001 144	350 10 350WGTZ	
10 S 22		D0826LFL		3400 125 501 ⊕ 3482 060 132 ⊕ 1878 001 077 ⊖ 3151 199 001	350 10 MF350 350GTZ KZIS-3	->02.1994
				3482 060 132	350 MF350	03.1994->
				1878 001 145	350 10 350WGTZ	03.1994->
				3151 199 001	KZIS-3	03.1994->
11...						
11 S 15 11 S 16	-03.96 -03.96	D0824LFL		3400 700 322 ⊖ ⊕ 3482 093 032 ⊕ 1862 438 032	330 10 MFZ330 330WTB	Je nach Kundenwunsch mit unterschiedlicher Kupplung / Equipped with different clutch according to customer requirement (33)
				3400 710 001 ⊕ 3482 120 031 ⊕ 1878 044 631 ↗ 3182 005 231	362 10 MFZ362 362GTZ HHISZ-3	
				3400 121 801 ⊖ ⊕ 3482 120 031 ⊕ 1878 044 631	362 10 MFZ362 362GTZ	Je nach Kundenwunsch mit unterschiedlicher Kupplung / Equipped with different clutch according to customer requirement (33)
11 S 15 (T72) 11 S 16 (T72)	04.96 - 04.96 -	D0824LFL		3400 121 701 ⊕ 3482 000 467 ⊕ 1862 506 131 ⊖ 3151 253 031	395 10 MFZ395 395WGTZ KZIZ-4,5	Je nach Kundenwunsch mit unterschiedlicher Kupplung / Equipped with different clutch according to customer requirement (33)
				3400 121 801 ⊖ ⊕ 3482 120 031 ⊕ 1878 044 631	362 10 MFZ362 362GTZ	Je nach Kundenwunsch mit unterschiedlicher Kupplung / Equipped with different clutch according to customer requirement (33)
				3400 710 001 ⊕ 3482 120 031 ⊕ 1878 044 631 ↗ 3182 005 231	362 10 MFZ362 362GTZ HHISZ-3	
11 S 18		WD612.63		3151 156 003	KZIZ-4,5	

		CODE				
--	--	------	--	---	---	---

STEYR











12...							
12 S 14		WD612.24	 3482 063 101 #	310			
			 1862 125 202 #	MFZ310	310 10		
			 3151 156 003	310GT	310GT		
12 S 15 12 S 16	-03.96 -03.96	D0824LFL	 3400 700 322 ☉	330 10	Je nach Kundenwunsch mit unterschiedlicher Kupplung / Equipped with different clutch according to customer requirement	(33)	
			 3482 093 032	MFZ330			330WTB
			 1862 438 032	362 10			
			 3400 710 001	MFZ362			
			 3482 120 031	362GTZ			
			 1878 044 631	HHISZ-3			
			 3182 005 231	362 10			
			 3400 121 801 ☉	MFZ362	362GTZ	Je nach Kundenwunsch mit unterschiedlicher Kupplung / Equipped with different clutch according to customer requirement	(33)
			 3482 120 031	362GTZ			
12 S 15 (T72) 12 S 16 (T72)	04.96 - 04.96 -	D0824LFL	 3400 121 701	395 10	Je nach Kundenwunsch mit unterschiedlicher Kupplung / Equipped with different clutch according to customer requirement	(33)	
			 3482 000 467	MFZ395			395WGTZ
			 1862 506 131	362 10			
			 1878 044 631	MFZ362			
			 3400 121 801 ☉	362GTZ	362GTZ	Je nach Kundenwunsch mit unterschiedlicher Kupplung / Equipped with different clutch according to customer requirement	(33)
			 3482 120 031	362 10			
			 1878 044 631	MFZ362			
			 3400 710 001	362GTZ	362GTZ		
			 3482 120 031	HHISZ-3			
			 1878 044 631	HHISZ-3			
			 1878 001 144	350 10			
			 350WGTZ				
12 S 21		WD612.75	 3482 067 101 #	380			
			 1878 001 152	380 10			
				GMFZ380			
				380WGTZ			
12 S 22 12 S 26	01.96 - 01.96 -	D0826	 3400 121 701	395 10			
			 3482 000 467	MFZ395			
			 1862 506 131	395WGTZ			
			 3151 253 031	KZIZ-4,5			











13...							
13 S 15 13 S 16	-03.96 -03.96	D0824LFL	 3400 700 322 ☉	330 10	Je nach Kundenwunsch mit unterschiedlicher Kupplung / Equipped with different clutch according to customer requirement	(33)	
			 3482 093 032	MFZ330			330WTB
			 1862 438 032	362 10			
			 3400 710 001	MFZ362			
			 3482 120 031	362GTZ			
			 1878 044 631	HHISZ-3			
			 3182 005 231	HHISZ-3			
			 3400 121 801 ☉	362 10			
			 3482 120 031	MFZ362	362GTZ	Je nach Kundenwunsch mit unterschiedlicher Kupplung / Equipped with different clutch according to customer requirement	(33)
13 S 15 (T72) 13 S 16 (T72)	04.96 - 04.96 -	D0824LFL	 3400 121 701	395 10	Je nach Kundenwunsch mit unterschiedlicher Kupplung / Equipped with different clutch according to customer requirement	(33)	
			 3482 000 467	MFZ395			395WGTZ
			 1862 506 131	362 10			
			 1878 044 631	MFZ362			
			 3400 121 801 ☉	362GTZ	362GTZ	Je nach Kundenwunsch mit unterschiedlicher Kupplung / Equipped with different clutch according to customer requirement	(33)
			 3482 120 031	362 10			
			 1878 044 631	MFZ362			
			 3400 710 001	362GTZ	362GTZ	Je nach Kundenwunsch mit unterschiedlicher Kupplung / Equipped with different clutch according to customer requirement	(33)
			 3482 120 031	HHISZ-3			
			 1878 044 631	HHISZ-3			
			 3151 156 003	KZIZ-4,5			
			 3151 156 003				
13 S 18		WD612.63	 3151 156 003	KZIZ-4,5			
13 S 22 13 S 26	01.96 - 01.96 -	D0826	 3400 121 701	395 10			
			 3482 000 467	MFZ395			
			 1862 506 131	395WGTZ			
			 3151 253 031	KZIZ-4,5			



14...						
14 S 14		WD612.24	 3482 063 101 #	310		
			 1862 125 202 #	MFZ310	310 10	
			 3151 156 003	310GT	310GT	
				KZIZ-4,5		

		CODE				
--	--	------	--	---	---	---

STEYR

14...						
14 S 15 14 S 16	-03.96 -03.96	D0824LFL		3400 700 322 ◐ ⊗ 3482 093 032 ⊗ 1862 438 032	330 10 MFZ330 330WTB	Je nach Kundenwunsch mit unterschiedlicher Kupplung / Equipped with different clutch according to customer requirement (33)
				3400 121 801 ◐ ⊗ 3482 120 031 ⊗ 1878 044 631	362 10 MFZ362 362GTZ	Je nach Kundenwunsch mit unterschiedlicher Kupplung / Equipped with different clutch according to customer requirement (33)
				3400 710 001 ⊗ 3482 120 031 ⊗ 1878 044 631 ↘ 3182 005 231	362 10 MFZ362 362GTZ HHISZ-3	
14 S 15 (T72) 14 S 16 (T72)	04.96 - 04.96 -	D0824LFL		3400 121 701 ⊗ 3482 000 467 ⊗ 1862 506 131 ◊ 3151 253 031	395 10 MFZ395 395WGTZ KZIZ-4,5	Je nach Kundenwunsch mit unterschiedlicher Kupplung / Equipped with different clutch according to customer requirement (33)
				3400 121 801 ◐ ⊗ 3482 120 031 ⊗ 1878 044 631	362 10 MFZ362 362GTZ	Je nach Kundenwunsch mit unterschiedlicher Kupplung / Equipped with different clutch according to customer requirement (33)
				3400 710 001 ⊗ 3482 120 031 ⊗ 1878 044 631 ↘ 3182 005 231	362 10 MFZ362 362GTZ HHISZ-3	
14 S 18		WD612.71, 73		1878 001 144	350 10 350WGTZ	
14 S 21		WD612.75		3482 067 101 #	380 GMFZ380	
				1878 001 152	380 10 380WGTZ	
14 S 22 14 S 26	01.96 - 01.96 -	D0826		3400 121 701 ⊗ 3482 000 467 ⊗ 1862 506 131 ◊ 3151 253 031	395 10 MFZ395 395WGTZ KZIZ-4,5	



15...						
15 S 15 15 S 16	-03.96 -03.96	D0824LFL		3400 700 322 ◐ ⊗ 3482 093 032 ⊗ 1862 438 032	330 10 MFZ330 330WTB	Je nach Kundenwunsch mit unterschiedlicher Kupplung / Equipped with different clutch according to customer requirement (33)
				3400 121 801 ◐ ⊗ 3482 120 031 ⊗ 1878 044 631	362 10 MFZ362 362GTZ	Je nach Kundenwunsch mit unterschiedlicher Kupplung / Equipped with different clutch according to customer requirement (33)
				3400 710 001 ⊗ 3482 120 031 ⊗ 1878 044 631 ↘ 3182 005 231	362 10 MFZ362 362GTZ HHISZ-3	
15 S 15 (T72) 15 S 16 (T72)	04.96 - 04.96 -	D0824LFL		3400 121 701 ⊗ 3482 000 467 ⊗ 1862 506 131 ◊ 3151 253 031	395 10 MFZ395 395WGTZ KZIZ-4,5	Je nach Kundenwunsch mit unterschiedlicher Kupplung / Equipped with different clutch according to customer requirement (33)
				3400 121 801 ◐ ⊗ 3482 120 031 ⊗ 1878 044 631	362 10 MFZ362 362GTZ	Je nach Kundenwunsch mit unterschiedlicher Kupplung / Equipped with different clutch according to customer requirement (33)
				3400 710 001 ⊗ 3482 120 031 ⊗ 1878 044 631 ↘ 3182 005 231	362 10 MFZ362 362GTZ HHISZ-3	
15 S 18		WD612.71, 73		1878 001 144	350 10 350WGTZ	
		WD612.63		3151 156 003	KZIZ-4,5	
15 S 21		WD612.75		3482 067 101 #	380 GMFZ380	
				1878 001 152	380 10 380WGTZ	
15 S 22 15 S 26	01.95 - 01.95 -	D0826		3400 121 701 ⊗ 3482 000 467 ⊗ 1862 506 131 ◊ 3151 253 031	395 10 MFZ395 395WGTZ KZIZ-4,5	





























16...						
16 S 18		WD612.71, 73		1878 001 144	350 10 350WGTZ	
16 S 21		WD612.75		3482 067 101 #	380 GMFZ380	
				1878 001 152	380 10 380WGTZ	

		CODE					
--	--	------	--	--	---	---	---

STEYR









17...							
17 S 18		WD612.63		3151 156 003	KZIZ-4,5		











18...								
18 S 26		WD612.34		3482 067 102 #	380			
				1878 001 152	380 10	GMFZ380 380WGTZ		
				3151 156 003		KZIZ-4,5		

19...								
19 S 28				1882 304 208	420	für Nebenantrieb / for PTO	(82)	
				1878 003 661	420 10	GF420N 420WGTZ	für Nebenantrieb / for PTO	(82)
				3151 082 001		KZI-6	für Nebenantrieb / for PTO mit Schmierrohranschluß / with lubricating pipe coupling	(82) (91)
19 S 29 T03	01.94 - 01.00	D2865LF24, D2865LF20, D2865LF21		3400 122 301	430 10			
19 S 34 T03	01.94 - 01.00			3482 083 032	MFZ430			
				1878 080 034	430WGTZ			
				3151 000 034	KZISZ-5			
				3482 114 031	430	für Fahrzeuge mit Nebenantrieb / for vehicles with PTO	(73)	
				1862 441 131 #	430 10	für Nebenantrieb / for PTO	(82)	
19 S 31		WD615.68, 78		3482 118 031	430			
				1878 003 661	420 10	GMF430 420WGTZ		
				3151 000 512		KZIS-4		
			1882 304 208	420	für Nebenantrieb / for PTO	(82)		
			1878 003 661	420 10	GF420N 420WGTZ	für Nebenantrieb / for PTO	(82)	
			3151 082 001		KZI-6	für Nebenantrieb / for PTO mit Schmierrohranschluß / with lubricating pipe coupling	(82) (91)	
19 S 37		WD815.66		3482 083 113	430			
				1862 315 101 #	430 10	MFZ430 430GVZ		
				3151 217 001		KZIZ-5		
19 S 40 19 S 46	D2840			3488 017 447	400	enthält eine Kupplungsscheibe / This part number includes one clutch disc	(66)	
				1878 002 643 ▽	400 10	Lose Kupplungsscheibe / Loose clutch disc	(39)	
				3151 262 031		400WGTZ KZISZ-5		
				1878 002 023 △	400 8	In 3483/3488 enthalten / Contained in 3483, 3488	(30)	
	D2866			3482 083 032	430			
				1878 004 832	430 10	MFZ430 430WGTZ		
				3151 000 034		KZISZ-5		
				3400 700 327	430 10	für Fahrzeuge mit Nebenantrieb / for vehicles with PTO	(73)	
			3482 114 031	GMFZ430N	01.1994->			
			1878 004 832	430WGTZ	für Nebenantrieb / for PTO	(82)		
			3151 263 031	KZIZ-6	für Nebenantrieb / for PTO	(82)		















		CODE					
--	--	------	--	--	---	---	---

STEYR

22...							
22 S 31		WD615.68, 78		3482 118 031	430 GMF430		
				1878 003 661	420 10 420WGTZ		
				3151 000 512	KZIS-4		
22 S 34		WD815.69		3482 083 113	430 MFZ430		
				1862 315 101 #	430 10 430GVZ		
				3151 217 001	KZIZ-5		
22 S 37		WD815.66		3482 083 113	430 MFZ430		
				1862 315 101 #	430 10 430GVZ		
				3151 217 001	KZIZ-5		



















23...							
23 S 34	01.94-			3400 122 301	430 10 MFZ430		
				3482 083 032	430WGTZ		
				1878 080 034	KZISZ-5		
				3151 000 034			
		D2865LF21		3482 114 031	430 GMFZ430N	für Fahrzeuge mit Nebenantrieb / for vehicles with PTO	(73)
				1862 441 131 #	430 10 430WGTZ	für Nebenantrieb / for PTO	(82)
				3151 263 031	KZIZ-6	für Nebenantrieb / for PTO	(82)
							
23 S 40 23 S 46	01.94 - 01.94 -	D2866, 2876		3482 083 032	430 MFZ430		
				1878 004 832	430 10 430WGTZ		
				3151 000 034	KZISZ-5		

25...							
25 S 22 25 S 26	06.95 - 06.95 -	D0826LF		3400 121 701	395 10 MFZ395		
				3482 000 467	395WGTZ		
				1862 506 131	KZIZ-4,5		
				3151 253 031			













26...							
26 S 29				3400 122 301	430 10 MFZ430		
				3482 083 032	430WGTZ		
				1878 080 034	KZISZ-5		
				3151 000 034			
		D2865		3482 114 031	430 GMFZ430N	für Fahrzeuge mit Nebenantrieb / for vehicles with PTO	(73)
				1862 441 131 #	430 10 430WGTZ	für Nebenantrieb / for PTO	(82)
				3151 263 031	KZIZ-6	für Nebenantrieb / for PTO	(82)
							
26 S 31		WD615.68, 78		3482 118 031	430 GMF430		
				1878 003 661	420 10 420WGTZ		
				3151 000 512	KZIS-4		
26 S 32		WD615.68		3482 083 113	430 MFZ430		
				1878 003 662	420 10 420WGTZ		
				3151 000 144	KZISZ-5		

STEYR



26...

26 S 34	WD815.69	 3482 083 113	430 MFZ430		
		 1862 315 101 #	430 10 430GVZ		
		 3151 217 001	KZIZ-5		
	D2865	 3400 122 301  3482 083 032  1878 080 034  3151 000 034	430 10 MFZ430 430WGTZ KZISZ-5		
		 3482 114 031	430 GMFZ430N	01.1994-> für Fahrzeuge mit Nebenantrieb / for vehicles with PTO für Nebenantrieb / for PTO	(73) (82)
		 1862 441 131 #	430 10 430WGTZ	01.1994-> für Nebenantrieb / for PTO	(82)
26 S 37	WD815.66	 3482 083 113	430 MFZ430		
		 1862 315 101 #	430 10 430GVZ		
		 3151 217 001	KZIZ-5		
26 S 40 T38 26 S 46	D2866	 3400 122 301  3482 083 032  1878 080 034  3151 000 034	430 10 MFZ430 430WGTZ KZISZ-5		
		 3482 114 031	430 GMFZ430N	für Fahrzeuge mit Nebenantrieb / for vehicles with PTO für Nebenantrieb / for PTO	(73) (82)
		 1862 441 131 #	430 10 430WGTZ	für Nebenantrieb / for PTO	(82)
	 3151 263 031	KZIZ-6	für Nebenantrieb / for PTO	(82)	

32...







32 S 31	WD615.68, 78	 3482 118 031	430 GMF430		
		 1878 003 661	420 10 420WGTZ		
		 3151 000 512	KZIS-4		
32 S 34	WD815.69	 3482 083 113	430 MFZ430		
		 1862 315 101 #	430 10 430GVZ		
		 3151 217 001	KZIZ-5		
	WD815.74	 3482 118 031	430 GMF430		
		 1878 002 706	420 10 420GTZ		
		 3151 000 512	KZIS-4		
32 S 37	WD815.66	 3482 083 113	430 MFZ430		
		 1862 315 101 #	430 10 430GVZ		
		 3151 217 001	KZIZ-5		



33...



33 S 40	D2866	 3400 122 301  3482 083 032  1878 080 034  3151 000 034	430 10 MFZ430 430WGTZ KZISZ-5		
		 3482 114 031	430 GMFZ430N	für Fahrzeuge mit Nebenantrieb / for vehicles with PTO für Nebenantrieb / for PTO	(73) (82)
		 1862 441 131 #	430 10 430WGTZ	für Nebenantrieb / for PTO	(82)
		 3151 263 031	KZIZ-6	für Nebenantrieb / for PTO	(82)





		CODE					
--	--	------	--	--	---	---	---











STEYR

33...							
33 S 46		D2840		3488 017 447	400 MFZ2/400X	enthält eine Kupplungsscheibe / This part number includes one clutch disc	(66)
				1878 002 643 ▽	400 10 400WGTZ	Lose Kupplungsscheibe / Loose clutch disc	(39)
				3151 262 031	KZISZ-5		
				1878 002 023 △	400 8 400GTZ	In 3483/3488 enthalten / Contained in 3483, 3488	(30)
		D2876		3400 122 201 ● 3482 083 032 ● 1878 004 832 ● 3151 000 034	430 10 MFZ430 430WGTZ KZISZ-5		
				3400 700 327 ● 3482 114 031 ● 1878 004 832 ● 3151 263 031	430 10 GMFZ430N 430WGTZ KZIZ-6	für Fahrzeuge mit Nebenantrieb / for vehicles with PTO für Nebenantrieb / for PTO	(73) (82)

35...							
35 S 36 T46 35 S 41 T46	06.98 - 06.98 -	D2866LF31, D2866LF35		3400 122 201 ● 3482 083 032 ● 1878 004 832 ● 3151 000 034	430 10 MFZ430 430WGTZ KZISZ-5		
				3400 700 327 ● 3482 114 031 ● 1878 004 832 ● 3151 263 031	430 10 GMFZ430N 430WGTZ KZIZ-6	für Fahrzeuge mit Nebenantrieb / for vehicles with PTO für Nebenantrieb / for PTO	(73) (82)











41...							
41 S 36 T46 41 S 40 T46 41 S 41 T46 41 S 46 T46	06.98 - 08.95 - 06.98 - 08.95 -	D2876LF03, D2866LF20, D2866LF31, D2876LF02, D2866LF35		3400 122 201 ● 3482 083 032 ● 1878 004 832 ● 3151 000 034	430 10 MFZ430 430WGTZ KZISZ-5		
				3400 700 327 ● 3482 114 031 ● 1878 004 832 ● 3151 263 031	430 10 GMFZ430N 430WGTZ KZIZ-6	für Fahrzeuge mit Nebenantrieb / for vehicles with PTO für Nebenantrieb / for PTO	(73) (82)

















42...							
42 S 40 42 S 46		D2866		3482 083 032	430 MFZ430	06.1996->	
				1878 004 832	430 10 430WGTZ	06.1996->	
				3151 000 034	KZISZ-5	06.1996->	
				3400 700 327 ● 3482 114 031 ● 1878 004 832 ● 3151 263 031	430 10 GMFZ430N 430WGTZ KZIZ-6	für Fahrzeuge mit Nebenantrieb / for vehicles with PTO für Nebenantrieb / for PTO	(73) (82)

60 - 991							
90				1864 347 102 #	350 22 350Z		
780 E		Ladermot.		1880 092 415 #	310 G310		
791		70, 77, 90, WD612.00, 20, 60, 67,		1882 110 513	350 GF350		
				1878 001 144	350 10 350WGTZ		
				3151 000 395	KZIS-4		
880 Z				1881 039 531 #	350 G350		
				1878 001 074	350 10 350GTZ		
890 990		614.01		1881 039 531 #	350 G350		
				1878 005 367	350 10 350WGTZ		
				3151 000 395	KZIS-4		

		CODE					
--	--	------	--	--	---	---	---

























STEYR

60 - 991							
891		WD612.60		1882 110 513	350 GF350		
				1878 001 144	350 10 350WGTZ		
				3151 000 395	KZIS-4		
990		+614.60, 230PS, WD614.01, 180PS		1882 261 013 #	380 G380N	Nebenantriebs-ID / PTO ID: 80/3	(48)
				3151 111 032	KZI-6	ohne Schmierrohranschluß / without lubricating pipe connection Nebenantriebs-ID / PTO ID: 80/3	(103) (48)
990 4x4		614.20		1881 039 531 #	350 G350		
				1878 005 367	350 10 350WGTZ		
				3151 000 395	KZIS-4		
991		WD615.00, 20		1882 327 003 #	380 GF380		
				1878 001 152	380 10 380WGTZ		
				3151 000 395	KZIS-4		

1090 - 2891							
1090 , a		WD610.42		1881 039 531 #	350 G350		
				1864 347 102 #	350 22 350Z		
1100 , a		WD610.40		1881 039 531 #	350 G350		
				1864 347 102 #	350 22 350Z		
1108 , a		WD610.44		1881 039 531 #	350 G350		
				1864 347 102 #	350 22 350Z		
1200 , a		WD610.43		1881 039 531 #	350 G350		
				1864 347 102 #	350 22 350Z		
1290 1490		614, 70		1882 327 003 #	380 GF380		
				3151 000 395	KZIS-4		
		WD614.60		1882 327 003 #	380 GF380		
				3151 000 395	KZIS-4		
1290 1490		D1815.60, 320PS, WD815.00, 270PS+W		3482 124 522	430 GMF430		
				1878 002 706	420 10 420GTZ		
				3151 000 395	KZIS-4		
1290 1490		+614.60, 230PS, WD614.01, 180PS		1882 261 013 #	380 G380N	Nebenantriebs-ID / PTO ID: 80/3	(48)
				3151 111 032	KZI-6	ohne Schmierrohranschluß / without lubricating pipe connection Nebenantriebs-ID / PTO ID: 80/3	(103) (48)

		CODE					
--	--	------	--	--	---	---	---

























STEYR

1090 - 2891							
1291 1491		69, 71, 75, 77, WD615.61, 65, 66, 67,		3482 124 522	430 GMF430		
				1878 003 661	420 10 420WGTZ		
	3151 000 512		KZIS-4				
WD615.60, 70				1882 327 003 #	380 GF380		
				1878 001 152	380 10 380WGTZ		
				3151 000 395	KZIS-4		
WD615.78				3482 118 031	430 GMF430	Getr. / GBox: ZF 16 S 130	
				1878 003 661	420 10 420WGTZ	Getr. / GBox: ZF 16 S 130	
				3151 000 512	KZIS-4	Getr. / GBox: ZF 16 S 130	
WD815.61, 63, 71				3482 124 522	430 GMF430		
				1878 002 706	420 10 420GTZ		
				3151 000 512	KZIS-4		
WD815.62, 64, 74				3482 118 031	430 GMF430		
				1878 002 706	420 10 420GTZ		
				3151 000 512	KZIS-4		
WD815.67, 68, 97				1882 342 134	420 GF420X		
				1878 002 706	420 10 420GTZ		
				3151 000 512	KZIS-4		
		WD815.61-69, 71, 75, 77		1878 003 661	420 10 420WGTZ	für Nebenantrieb / for PTO	(82)
				3151 082 001	KZI-6	für Nebenantrieb / for PTO mit Schmierrohranschluß / with lubricating pipe coupling	(82) (91)
1391		WD612.60		1882 110 513	350 GF350		
				1878 001 144	350 10 350WGTZ		
				3151 000 395	KZIS-4		
1490		WD614.60		1882 327 003 #	380 GF380		
				3151 000 395	KZIS-4		



		CODE					
--	--	------	--	--	---	---	---

STEYR



1090 - 2891

1891	69, 71, 75, 77, WD615.61, 65, 66, 67,	 3482 124 522	430 GMF430		
		 1878 003 661	420 10 420WGTZ		
		 3151 000 512	KZIS-4		
	WD815.61, 63, 71	 3482 124 522	430 GMF430		
		 1878 002 706	420 10 420GTZ		
		 3151 000 512	KZIS-4		
	WD815.62, 64, 74	 3482 118 031	430 GMF430		
		 1878 002 706	420 10 420GTZ		
		 3151 000 512	KZIS-4		
	WD815.67, 68, 97	 1882 342 134	420 GF420X		
		 1878 002 706	420 10 420GTZ		
		 3151 000 512	KZIS-4		
WD815.61-69, 71, 75, 77	 1878 003 661	420 10 420WGTZ	Nebenantriebs-ID / PTO ID: 110	(48)	
	 3151 082 001	KZI-6	mit Schmierrohranschluß / with lubricating pipe coupling	(91)	
1920	WD614e	 1882 327 003 #	380 GF380		
		 3151 000 395	KZIS-4		
2891	69, 71, 75, 77, WD615.61, 65, 66, 67,	 3482 124 522	430 GMF430		
		 1878 003 661	420 10 420WGTZ		
		 3151 000 512	KZIS-4		
	WD615.92, 93	 3482 118 031	430 GMF430		
		 1878 003 661	420 10 420WGTZ		
		 3151 000 512	KZIS-4		
	WD815.67, 68, 97	 1882 342 134	420 GF420X		
		 1878 002 706	420 10 420GTZ		
		 3151 000 512	KZIS-4		

Pinzgauer















































Pinzgauer 712 Pinzgauer 716, 717 Pinzgauer 720			 3082 007 333	240 MF240		
			 3151 011 001	KZI-1		

SL

SL 10 H 210 , 9 G		4F	 1882 325 134	380 G380		
			 3151 000 395	KZIS-4		



















		CODE					
--	--	------	--	--	---	---	---

STEYR









TG-A		01.00 -				
18 S 31 H05 H01 18 S 36 H01 H05 18 S 41 H01 H05	04.00-	D2866LF26, D2866LF27, D2866LF36, D2866LF28, D2866LF37, D2866LF32	 3400 127 401  3482 000 361  1878 004 832  3151 000 034	430 10 MFZ430 430WGTZ KZISZ-5	Getr. / GBox: ZF Ecosplit-3	
	04.00-		 3488 017 447	400 MFZ2/400X	Getr. / GBox: ZF Ecosplit-3 für Fahrzeuge mit Zweischeibenkupplung / for vehicles with double disc clutch enthält eine Kupplungsscheibe / This part number includes one clutch disc	(77) (66)
	04.00-		 1878 002 643	400 10 400WGTZ	Getr. / GBox: ZF Ecosplit-3 für Fahrzeuge mit Zweischeibenkupplung / for vehicles with double disc clutch	(77)
			 3151 262 031	KZISZ-5	Getr. / GBox: ZF Ecosplit-3 für Fahrzeuge mit Zweischeibenkupplung / for vehicles with double disc clutch	(77)
			 3400 700 327  3482 114 031  1878 004 832  3151 263 031	430 10 GMFZ430N 430WGTZ KZISZ-6	Getr. / GBox: ZF 16S-151/181 für Fahrzeuge mit Nebenantrieb / for vehicles with PTO	(73) (82)
			 3400 700 403  3482 000 361  1878 004 832  3151 000 144	430 10 MFZ430 430WGTZ KZISZ-5	Getr. / GBox: AS-Tronic für Ausrückgabel mit Nocken / for release fork with cams	(69)
			 3400 700 450  3482 000 361  1878 004 832  3151 000 493	430 10 MFZ430 430WGTZ KZISZ-5	Getr. / GBox: AS-Tronic für Ausrückgabel mit Rollen / for release fork with rollers	(70)
	18 S 46 H05 H01 18 S 51 H05	04.00-	D2876LF07, D2876LF08, D2676LF05, D2876LF04	 3400 700 402  3482 000 246  1878 002 139  3151 000 034	430 10 MFZ430 430WGTZ KZISZ-5	Getr. / GBox: ZF Ecosplit-3 Getr. / GBox: Eaton
04.00-			 3400 700 460 HD  3482 000 246  1878 004 104  3151 000 034	430 10 MFZ430 430WGTZ KZISZ-5	Getr. / GBox: ZF Ecosplit-3 Getr. / GBox: Eaton	
			 3488 017 447	400 MFZ2/400X	Getr. / GBox: ZF Ecosplit-3 für Fahrzeuge mit Zweischeibenkupplung / for vehicles with double disc clutch enthält eine Kupplungsscheibe / This part number includes one clutch disc	(77) (66)
			 1878 002 643	400 10 400WGTZ	Getr. / GBox: ZF Ecosplit-3 für Fahrzeuge mit Zweischeibenkupplung / for vehicles with double disc clutch	(77)
			 3151 262 031	KZISZ-5	Getr. / GBox: ZF Ecosplit-3 für Fahrzeuge mit Zweischeibenkupplung / for vehicles with double disc clutch	(77)
			 3400 700 327  3482 114 031  1878 004 832  3151 263 031	430 10 GMFZ430N 430WGTZ KZISZ-6	Getr. / GBox: ZF 16S-151/185 für Fahrzeuge mit Nebenantrieb / for vehicles with PTO	(73) (82)
			 3400 700 404  3482 000 246  1878 002 139  3151 000 144	430 10 MFZ430 430WGTZ KZISZ-5	Getr. / GBox: AS-Tronic	
			 3400 700 445  3482 000 246  1878 002 139  3151 000 493	430 10 MFZ430 430WGTZ KZISZ-5	Getr. / GBox: AS-Tronic für Ausrückgabel mit Rollen / for release fork with rollers	(70)
		 3400 700 459 HD  3482 000 246  1878 004 104  3151 000 493	430 10 MFZ430 430WGTZ KZISZ-5	Getr. / GBox: AS-Tronic für Ausrückgabel mit Rollen / for release fork with rollers	(70)	

		CODE			 Parameter		
--	--	------	--	--	---	---	---

STEYR

TG-A		01.00 -					
26 S 31 H17 H86 26 S 36 H86 H17	09.00 -	D2866LF26, D2866LF27, D2866LF36, D2866LF37		3400 127 401  3482 000 361  1878 004 832  3151 000 034	430 10 MFZ430 430WGTZ KZISZ-5	Getr. / GBox: ZF Ecosplit-3	
	09.00 -			3488 017 447	400 MFZ2/400X	Getr. / GBox: ZF Ecosplit-3 für Fahrzeuge mit Zweischeibenkupplung / for vehicles with double disc clutch enthält eine Kupplungsscheibe / This part number includes one clutch disc	(77) (66)
				1878 002 643	400 10 400WGTZ	Getr. / GBox: ZF Ecosplit-3 für Fahrzeuge mit Zweischeibenkupplung / for vehicles with double disc clutch	(77)
				3151 262 031	KZISZ-5	Getr. / GBox: ZF Ecosplit-3 für Fahrzeuge mit Zweischeibenkupplung / for vehicles with double disc clutch	(77)
				3400 700 403  3482 000 361  1878 004 832  3151 000 144	430 10 MFZ430 430WGTZ KZISZ-5	Getr. / GBox: ZF-AS-Tronic für Ausrückgabel mit Nocken / for release fork with cams	(69)
				3400 700 450  3482 000 361  1878 004 832  3151 000 493	430 10 MFZ430 430WGTZ KZISZ-5	Getr. / GBox: ZF-AS-Tronic für Ausrückgabel mit Rollen / for release fork with rollers	(70)
				3400 700 327  3482 114 031  1878 004 832  3151 263 031	430 10 GMFZ430N 430WGTZ KZISZ-6	Getr. / GBox: ZF 16S-151/181 für Fahrzeuge mit Nebenantrieb / for vehicles with PTO für Nebenantrieb / for PTO	(73) (82)











TAM

Nkw							
75 A5,6 75 T3B,4B 75 T5B,BK 5000 5000 5000 DC,HS,DVC 5000 F,K,P				1880 083 132 #	280 G280		
				1882 137 307 #	310 GF310		
110 T-10				1861 600 033 #	310 10 310GTD		
				3482 008 036 #	310 MF310		
122 T8				1861 034 147 #	350 10 350		
125 T10,12 125 T12 4x4 5500 5500,G 5500 DK,QG 6500 K,GO 6500 SN,BVL				1878 001 074	350 10 350GTZ		
150 T11B 6x6 150 T11BV 6x6				1882 325 134	380 G380		
				1878 001 152	380 10 380WGTZ		
190 T15 3,5 190 T15 4,1 190 T15 4x4 3,5 190 TBK 3,5				1878 003 657	420 10 420WGTZ		













		CODE				
--	--	------	--	---	---	---

VOLKSWAGEN



CRAFTER 30-50 Kasten / Box (2E) 04.06 -

2.5 TDI, 65 kW	04.06-07.11	BJJ, CEBA		3000 990 204 3000 951 841 3182 997 804	240 HHAS-1	XTend Kit plus CSC	
				1863 869 012	28	Nadellager / Needle Bearing	(47)
				6284 605 004			
2.5 TDI, 80 kW 2.5 TDI, 100 kW	04.06-04.06-	BJK, CEBB, BJL, CECA		3000 990 204  3000 951 841 3182 997 804	240 HHAS-1	XTend Kit plus CSC	
				3000 990 217 3000 951 876 3182 997 802	240 HHAS-1	XTend Kit plus CSC Getr. / GBox: Shiftmatic (SMC)	
				1863 869 012	28	Nadellager / Needle Bearing	(47)
2.5 TDI, 120 kW	04.06-07.11	BJM, CECB		3000 990 217 3000 951 876 3182 997 802	240 HHAS-1	XTend Kit plus CSC Getr. / GBox: Shiftmatic (SMC)	
				3000 990 246  3000 951 932 3182 997 804	260 26 HHAS-1	XTend Kit plus CSC	
				1863 869 012	28	Nadellager / Needle Bearing	(47)















CRAFTER 30-50 Pritsche / Flatbed (2E) 04.06 -

2.5 TDI, 65 kW	04.06-07.11	BJJ, CEBA		3000 990 204 3000 951 841 3182 997 804	240 HHAS-1	XTend Kit plus CSC	
				1863 869 012	28	Nadellager / Needle Bearing	(47)
				6284 605 004			
2.5 TDI, 80 kW 2.5 TDI, 100 kW	04.06-04.06-	BJK, CEBB, BJL, CECA		3000 990 204  3000 951 841 3182 997 804	240 HHAS-1	XTend Kit plus CSC	
				3000 990 217 3000 951 876 3182 997 802	240 HHAS-1	XTend Kit plus CSC Getr. / GBox: Shiftmatic (SMC)	
				1863 869 012	28	Nadellager / Needle Bearing	(47)
2.5 TDI, 120 kW	04.06-07.11	BJM, CECB		3000 990 217 3000 951 876 3182 997 802	240 HHAS-1	XTend Kit plus CSC Getr. / GBox: Shiftmatic (SMC)	
				3000 990 246  3000 951 932 3182 997 804	260 26 HHAS-1	XTend Kit plus CSC	
				1863 869 012	28	Nadellager / Needle Bearing	(47)
				6284 605 004 			

L 80 07.95 - 12.00

4.3 4.3	07.95-12.00 07.95-12.00	AGF		3482 934 001	325 MF325		
				1878 859 001	325 10 325CPB		
				3151 997 201	KZI-3		















LT 28-35 I Kasten / Box (281-363) 04.75 - 06.96

2.4	12.82-07.92	DL		3000 055 006  3082 190 031  1861 897 034  3151 193 041	228 23 M228 228TB KZIS-0		
				1863 869 002	24	Nadellager / Needle Bearing	(47)
				3074 003 343 		08.1989->	
2.4 i	03.94-06.96	1E		3000 055 006  3082 190 031  1861 897 034  3151 193 041	228 23 M228 228TB KZIS-0		
				1863 869 002	24	Nadellager / Needle Bearing	(47)
				3074 003 343 		->12.1995	















		CODE					
--	--	------	--	--	---	---	---

VOLKSWAGEN

LT 28-35 | Kasten / Box (281-363) 04.75 - 06.96

2.4 D, 51 kW 2.4 TD, 70 kW	07.90-05.96 06.92-05.96	ACL, 1S, ACT	 3000 055 005 ⊗ 3082 190 031 ⊗ 1878 004 776 ⊙ 3151 193 041	228 23 M228 220VTPB KZIS-0		
			 1863 869 002	24	Nadellager / Needle Bearing	(47)
			 3074 003 343 <small>LHD</small>		->12.1995	
2.4 D, 55 kW	01.79-07.92	DW, CP	 3000 055 005 ⊗ 3082 190 031 ⊗ 1878 004 776 ⊙ 3151 193 041	228 23 M228 220VTPB KZIS-0		
			 1863 869 002	24	Nadellager / Needle Bearing	(47)
		DW	 3074 003 343 <small>LHD</small>		08.1989->	
2.4 TD, 68 kW	08.88-08.92	1G	 3000 055 005 ⊗ 3082 190 031 ⊗ 1878 004 776 ⊙ 3151 193 041	228 23 M228 220VTPB KZIS-0		
			 1863 869 002	24	Nadellager / Needle Bearing	(47)
2.4 TD, 75 kW	02.86-08.92	DV	 3000 055 005 ⊗ 3082 190 031 ⊗ 1878 004 776 ⊙ 3151 193 041	228 23 M228 220VTPB KZIS-0		
			 1863 869 002	24	Nadellager / Needle Bearing	(47)
			 3074 003 343 <small>LHD</small>		08.1989->	
2.7 D	11.75-01.80	Perkins	 3082 086 434	228 M228		
			 1861 897 034	228 23 228TB		
			 3151 193 041	KZIS-0		









LT 28-35 | Pritsche / Flatbed (281-363) 04.75 - 06.96

2.4	12.82-07.92	DL	 3000 055 006 ⊗ 3082 190 031 ⊗ 1861 897 034 ⊙ 3151 193 041	228 23 M228 228TB KZIS-0		
			 1863 869 002	24	Nadellager / Needle Bearing	(47)
			 3074 003 343 <small>LHD</small>		08.1989->	
2.4 i	03.94-06.96	1E	 3000 055 006 ⊗ 3082 190 031 ⊗ 1861 897 034 ⊙ 3151 193 041	228 23 M228 228TB KZIS-0		
			 1863 869 002	24	Nadellager / Needle Bearing	(47)
			 3074 003 343 <small>LHD</small>		->12.1995	
2.4 D, 51 kW	08.90-06.96	1S, ACT	 3000 055 005 ⊗ 3082 190 031 ⊗ 1878 004 776 ⊙ 3151 193 041	228 23 M228 220VTPB KZIS-0		
			 1863 869 002	24	Nadellager / Needle Bearing	(47)
			 3074 003 343 <small>LHD</small>		->12.1995	
2.4 D, 55 kW	12.78-02.91	DW, CP	 3000 055 005 ⊗ 3082 190 031 ⊗ 1878 004 776 ⊙ 3151 193 041	228 23 M228 220VTPB KZIS-0		
			 1863 869 002	24	Nadellager / Needle Bearing	(47)
		DW	 3074 003 343 <small>LHD</small>		08.1989->	
2.4 TD, 68 kW 2.4 TD, 70 kW	08.90-08.92 08.92-06.96	ACL, 1G	 3000 055 005 ⊗ 3082 190 031 ⊗ 1878 004 776 ⊙ 3151 193 041	228 23 M228 220VTPB KZIS-0		
			 1863 869 002	24	Nadellager / Needle Bearing	(47)











































		CODE				
--	--	------	--	---	---	---

VOLKSWAGEN

LT 28-35 I Pritsche / Flatbed (281-363) 04.75 - 06.96

2.4 TD, 75 kW	12.82-09.93	DV	 3000 055 005  3082 190 031  1878 004 776  3151 193 041	228 23 M228 220VTPB KZIS-0		
			 1863 869 002	24	Nadellager / Needle Bearing	(47)
			 3074 003 343		08.1989 - 08.1992	
2.7 D	11.75-01.80	Perkins	 3082 086 434	228 M228		
			 1861 897 034	228 23 228TB		
			 3151 193 041	KZIS-0		















LT 28-46 II Kasten / Box (2DX0AE) 04.96 - 07.06

2.3	05.96-07.06	AGL	 3000 826 901  3082 268 031  1878 994 001  3151 248 031	240 26 M240 240TB KZIS-0		
			 6283 600 115			
			 6284 600 573			
2.5 SDI	09.96-07.06	AGX	 3000 845 801  3082 639 402  1878 988 102  3151 248 031	240 26 MF240 240TB KZIS-0		
			 1863 869 005	24	Nadellager / Needle Bearing	(47)
			 6283 600 115			
			 6284 600 573			
2.5 TDI, 61 kW 2.5 TDI, 70 kW	05.01-07.06 05.01-07.06	BBF, BBE	 3000 951 104  3082 600 522  1878 988 102  3151 248 031	240 26 M240 240TB KZIS-0		
			 1863 869 005	24	Nadellager / Needle Bearing	(47)
			 6283 600 115			
			 6284 600 573			
2.5 TDI, 66 kW	05.99-07.06	APA	 3000 845 101  3082 308 043  1878 988 102  3151 248 031	240 26 MF240 240TB KZIS-0		
			 1863 869 005	24	Nadellager / Needle Bearing	(47)
			 6283 600 115			
			 6284 600 573			
2.5 TDI, 75 kW	05.96-08.99	AHD	 3000 828 601  3082 308 043  1864 528 442  3151 248 031	240 26 MF240 240B KZIS-0	->Mot. 047 378 für / for: LT 28/35	(68)
			 3000 845 101  3082 308 043  1878 988 102  3151 248 031	240 26 MF240 240TB KZIS-0	Mot. 047 379-> für / for: LT 28/35	(68)
			 3000 845 101  3082 308 043  1878 988 102  3151 248 031	240 26 MF240 240TB KZIS-0	für / for: LT 46	(68)
			 1863 869 005	24	Nadellager / Needle Bearing	(47)
			 6283 600 115			
			 6284 600 573			















		CODE		 Parameter		
--	--	------	--	---	---	---

VOLKSWAGEN

LT 28-46 II Kasten / Box (2DX0AE) 04.96 - 07.06

2.5 TDI, 80 kW	05.99 - 07.06	ANJ		3000 951 710 ⊗ 3082 600 509 ⊗ 1878 988 102 ⊙ 3151 248 031	240 26 MF240 240TB KZIS-0	-->Mot. 052609		
				3000 951 104 ⊗ 3082 600 522 ⊗ 1878 988 102 ⊙ 3151 248 031	240 26 M240 240TB KZIS-0	Mot. 052610->		
		AVR		3000 951 104 ⊗ 3082 600 522 ⊗ 1878 988 102 ⊙ 3151 248 031	240 26 M240 240TB KZIS-0			
		AVR, ANJ		1863 869 005	24	Nadellager / Needle Bearing	(47)	
				6283 600 115				
				6284 600 573				
2.8 TDI, 92 kW 2.8 TDI, 96 kW	06.97 - 12.98 01.99 - 07.06	ATA, AGK		3000 845 001 ⊗ 3082 919 001 ⊗ 1864 528 442 ⊙ 3151 248 031	240 26 MF240 240B KZIS-0			
				1863 869 005	24	Nadellager / Needle Bearing	(47)	
					6283 600 115			
					6284 600 573			
2.8 TDI, 116 kW	04.02 - 07.06	AUH, BCQ		3000 951 107 ■	240 26	XTend ->Chass. 2D-2-036 000 Nabenprofil / Hub Profile: 26,5x28,9-26N nur in Verbindung mit / only in connection with: 062 105 266 F	(46) (101)	
				3000 951 107 ■	240 26	XTend Chass. 2D-2-036 001-> Nabenprofil / Hub Profile: 26,5x28,9-26N	(46)	
		AUH		6283 600 115				
		BCQ, AUH		6284 600 573				

























LT 28-46 II Pritsche / Flatbed (2DX0FE) 04.96 - 07.06

2.3	06.96 - 07.06	AGL		3000 826 901 ⊗ 3082 268 031 ⊗ 1878 994 001 ⊙ 3151 248 031	240 26 M240 240TB KZIS-0			
				6283 600 115				
				6284 600 573				
2.5 SDI	09.96 - 07.06	AGX		3000 845 801 ⊗ 3082 639 402 ⊗ 1878 988 102 ⊙ 3151 248 031	240 26 MF240 240TB KZIS-0			
				1863 869 005	24	Nadellager / Needle Bearing	(47)	
					6283 600 115			
				6284 600 573				
2.5 TDI, 61 kW	05.01 - 07.06	BBE		3000 951 104 ⊗ 3082 600 522 ⊗ 1878 988 102 ⊙ 3151 248 031	240 26 M240 240TB KZIS-0			
				1863 869 005	24	Nadellager / Needle Bearing	(47)	
					6283 600 115			
					6284 600 573			
2.5 TDI, 66 kW	05.99 - 07.06	APA		3000 845 101 ⊗ 3082 308 043 ⊗ 1878 988 102 ⊙ 3151 248 031	240 26 MF240 240TB KZIS-0			
				1863 869 005	24	Nadellager / Needle Bearing	(47)	
					6283 600 115			
					6284 600 573			



		CODE					
--	--	------	--	--	---	---	---

VOLKSWAGEN

LT 28-46 II Pritsche / Flatbed (2DX0FE) 04.96 - 07.06

2.5 TDI, 70 kW	05.01 - 07.06	BBF	 3000 951 104 ⊗ 3082 600 522 ⊗ 1878 988 102 ⊙ 3151 248 031	240 26 M240 240TB KZIS-0		
			 1863 869 005	24	Nadellager / Needle Bearing	(47)
			 6283 600 115			
2.5 TDI, 75 kW	06.96 - 08.99	AHD	 3000 828 601 ⊗ 3082 308 043 ⊗ 1864 528 442 ⊙ 3151 248 031	240 26 MF240 240B KZIS-0	->Mot. 047 378 für / for: LT 28/35	(68)
			 3000 845 101 ⊗ 3082 308 043 ⊗ 1878 988 102 ⊙ 3151 248 031	240 26 MF240 240TB KZIS-0	Mot. 047 379-> für / for: LT 28/35	(68)
			 3000 845 101 ⊗ 3082 308 043 ⊗ 1878 988 102 ⊙ 3151 248 031	240 26 MF240 240TB KZIS-0	für / for: LT 46	(68)
			 1863 869 005	24	Nadellager / Needle Bearing	(47)
			 6283 600 115			
			 6284 600 573			
2.5 TDI, 80 kW	05.99 - 07.06	ANJ	 3000 951 710 ⊗ 3082 600 509 ⊗ 1878 988 102 ⊙ 3151 248 031	240 26 MF240 240TB KZIS-0	->Mot. 052609	
			 3000 951 104 ⊗ 3082 600 522 ⊗ 1878 988 102 ⊙ 3151 248 031	240 26 M240 240TB KZIS-0	Mot. 052610->	
			 3000 951 104 ⊗ 3082 600 522 ⊗ 1878 988 102 ⊙ 3151 248 031	240 26 M240 240TB KZIS-0		
		AVR	 3000 951 104 ⊗ 3082 600 522 ⊗ 1878 988 102 ⊙ 3151 248 031	240 26 M240 240TB KZIS-0		
		AVR, ANJ	 3151 248 031	KZIS-0		
		 1863 869 005	24	Nadellager / Needle Bearing	(47)	
2.8 TDI, 92 kW 2.8 TDI, 96 kW	06.97 - 12.98 01.99 - 07.06	ATA, AGK	 3000 845 001 ⊗ 3082 919 001 ⊗ 1864 528 442 ⊙ 3151 248 031	240 26 MF240 240B KZIS-0		
			 1863 869 005	24	Nadellager / Needle Bearing	(47)
			 6283 600 115			
			 6284 600 573			
2.8 TDI, 116 kW	04.02 - 07.06	AUH, BCQ	 3000 951 107 	240 26	XTend ->Chass. 2D-2-036 000 Nabenprofil / Hub Profile: 26,5x28,9-26N nur in Verbindung mit / only in connection with: 062 105 266 F	(46) (101)
			 3000 951 107 	240 26	XTend Chass. 2D-2-036 001-> Nabenprofil / Hub Profile: 26,5x28,9-26N	(46)
		AUH	 6283 600 115			
		BCQ, AUH	 6284 600 573			











LT 40-55 I Kasten / Box (291-512) 04.75 - 06.96

2.4 2.4 4WD	12.82 - 07.92 12.82 - 07.92	DL	 3000 055 006 ⊗ 3082 190 031 ⊗ 1861 897 034 ⊙ 3151 193 041	228 23 M228 228TB KZIS-0		
			 1863 869 002	24	Nadellager / Needle Bearing	(47)
			 3074 003 343 <small>LHD</small>		08.1989->	











		CODE					
--	--	------	--	--	---	---	---

VOLKSWAGEN

LT 40-55 | Kasten / Box (291-512) 04.75 - 06.96





















2.4 i	01.93-06.96	1E		3000 055 006  3082 190 031  1861 897 034  3151 193 041	228 23 M228 228TB KZIS-0		
				1863 869 002	24	Nadellager / Needle Bearing	(47)
				3074 003 343 <small>LHD</small>		->12.1995	
2.4 D, 51 kW	07.90-05.96	DW, 1S, ACL, ACT, CP, DV, 1G		3000 055 005  3082 190 031  1878 004 776  3151 193 041	228 23 M228 220VTPB KZIS-0		
2.4 D, 55 kW	01.79-07.92						
2.4 D 4WD	01.79-03.86						
2.4 TD, 68 kW	08.88-08.92						
2.4 TD, 70 kW	06.92-05.96						
2.4 TD, 75 kW	02.86-08.92						
2.4 TD 4WD	08.78-07.92						

LT 40-55 | Pritsche / Flatbed (293-909) 04.75 - 06.96

2.4 i	03.94-06.96	1E		3000 055 006  3082 190 031  1861 897 034  3151 193 041	228 23 M228 228TB KZIS-0		
				1863 869 002	24	Nadellager / Needle Bearing	(47)
				3074 003 343 <small>LHD</small>		->12.1995	
2.4 D, 51 kW	08.90-06.96	1S, DW, ACL, ACT, CP, DV		3000 055 005  3082 190 031  1878 004 776  3151 193 041	228 23 M228 220VTPB KZIS-0		
2.4 D, 55 kW	12.78-02.91						
2.4 TD, 70 kW	08.92-06.96						
2.4 TD, 75 kW	12.82-09.93						

























VOLVO

F 7 08.78 - 12.85





















F 7 F 7 F 7 F 7	08.78-12.85	KF115B		1882 325 134	380 G380	->Chass. 2162 Getr. / GBox: R52		
				1878 000 961	380 10 380GTZ	->Chass. 2162 Getr. / GBox: R52		
				3151 824 005	KZA-4	->Chass. 2162 Getr. / GBox: R52		
				3400 037 032  3482 021 031  1878 000 961  3151 824 005	380 10 GM380 380GTZ KZA-4	Chass. 2163-> Getr. / GBox: R52		
	08.78-12.85	KF214C		1888 019 445 #	350 GF2/350	Getr. / GBox: R52 enthält eine Kupplungsscheibe / This part number includes one clutch disc	(66)	
				1878 001 083 ▽	350 10 350GTZ	Getr. / GBox: R52 Lose Kupplungsscheibe / Loose clutch disc	(39)	
				3151 600 533	KZA-4	Getr. / GBox: R52		
				1859 170 204	350 GF2/350	Getr. / GBox: R52 In 1888 enthalten / Contained in 1888	(29)	
	08.78-12.85	KF214F		1800 106 033  1882 250 143  1878 001 080  1878 001 082  3151 106 041  1874 000 098	350 10 GF2/350 350GTZ 350GTZ KZI-5	Getr. / GBox: R/SR62 ohne Zwischenring / without intermediate ring	(105)	
				1888 019 542 #	350 GF2/350	Getr. / GBox: R/SR62 enthält eine Kupplungsscheibe / This part number includes one clutch disc	(66)	
				1878 001 082 ▽	350 10 350GTZ	Getr. / GBox: R/SR62 Lose Kupplungsscheibe / Loose clutch disc	(39)	
				3151 106 041	KZI-5	Getr. / GBox: R/SR62		
					1859 170 204	350 GF2/350	Getr. / GBox: R/SR62 In 1888 enthalten / Contained in 1888	(29)

		CODE		 Parameter		
--	--	------	--	---	---	---

VOLVO

































F 10		08.77 - 12.94			
Mot. TD 100	01.77-	KF215L	 1888 015 515 # 380 10 GF2/380 Getr. / GBox: MR62 enthält eine Kupplungsscheibe / This part number includes one clutch disc (66)		
			 1878 000 968 ▽ 380 10 380GTZ Getr. / GBox: MR62 Lose Kupplungsscheibe / Loose clutch disc (39)		
			 3151 106 041 KZI-5 Getr. / GBox: MR62		
			 1882 280 213 380 GF2/380 Getr. / GBox: MR62 In 1888 enthalten / Contained in 1888 (29)		
			 1859 212 000 380 GF2/380 Getr. / GBox: MR62 In 1888 enthalten / Contained in 1888 (29)		
			 1878 000 965 △ 380 10 380GTZ Getr. / GBox: MR62 In 1888 enthalten / Contained in 1888 (29)		
		KF215K	 1882 280 140 380 GF2/380 Getr. / GBox: MR62B		
			 1859 212 000 380 GF2/380 Getr. / GBox: MR62B		
			 1878 000 965 △ 380 10 380GTZ Getr. / GBox: MR62B		
			 1878 000 968 ▽ 380 10 380GTZ Getr. / GBox: MR62B		
Mot. TD 100, 101	01.77-	KF214F, H	 1800 106 033 350 10 GF2/350 Getr. / GBox: R/SR62 ohne Zwischenring / without intermediate ring (105)		
			 1888 019 542 # 350 GF2/350 Getr. / GBox: R/SR62 enthält eine Kupplungsscheibe / This part number includes one clutch disc (66)		
			 1878 001 082 ▽ 350 10 350GTZ Getr. / GBox: R/SR62		
			 3151 106 041 KZI-5 Getr. / GBox: R/SR62		
			 1859 170 204 350 GF2/350 Getr. / GBox: R/SR62 In 1888 enthalten / Contained in 1888 (29)		
			KF116B	 3482 119 032 430 GMF430 Getr. / GBox: R/SR62	
		 1878 003 242 420 10 420GTZ Getr. / GBox: R/SR62			
		 3151 105 141 KZI-5 Getr. / GBox: R/SR62			
		Mot. TD 101, 102, 103		01.83-	KFD214A
			 3488 013 138 ⊕ 350 GMFZ2/350 Getr. / GBox: R/SR1400, 1700 enthält eine Kupplungsscheibe / This part number includes one clutch disc (66)		
 1878 001 082 ▽ 350 10 350GTZ Getr. / GBox: R/SR1400, 1700 Lose Kupplungsscheibe / Loose clutch disc (39)					
 3482 056 031 350 GMFZ2/350 Getr. / GBox: R/SR1400, 1700 In 3483/3488 enthalten / Contained in 3483, 3488 (30)					
 3459 000 009 350 GMFZ2/350 Getr. / GBox: R/SR1400, 1700					
KFD117B, C	 3400 106 031 ⊕ 430 10 MFZ430 Getr. / GBox: R/SR1400, 1700				
	 3400 040 032 ●⊕ 430 10 MFZ430 Getr. / GBox: R/SR1400, 1700				
	 3482 123 235 430 MFZ430 Getr. / GBox: R/SR1400, 1700 In 3483/3488 enthalten / Contained in 3483, 3488 (30)				

VOLVO































F 12		08.77 - 12.94						
Mot. TD 120	01.77 -	KF215K	 1882 280 140	380 GF2/380	Getr. / GBox: MR62B			
			 1859 212 000	380 GF2/380	Getr. / GBox: MR62B			
			 1878 000 968 ▽	380 10 380GTZ	Getr. / GBox: MR62B			
			 1878 000 965 △	380 10 380GTZ	Getr. / GBox: MR62B			
			 3151 106 041	KZI-5	Getr. / GBox: MR62B			
Mot. TD 120, 121	01.77 -	KF215D, G	 3400 116 501	380 10 GTF380	Getr. / GBox: R/SR70,71		(105)	
			 3482 026 332	380GSZ	ohne Zwischenring / without intermediate ring			
			 1861 907 132	380GVZ				
			 1861 996 137	KZI-5				
			 3151 106 041					
			 1874 000 098					
			 3488 007 631	380 GTF2/380	Getr. / GBox: R/SR70,71 enthält eine Kupplungsscheibe / This part number includes one clutch disc			(66)
			 1861 996 137 ▽	380 10 380GVZ	Getr. / GBox: R/SR70,71 Lose Kupplungsscheibe / Loose clutch disc			(39)
		 3151 106 041	KZI-5	Getr. / GBox: R/SR70,71				
		 3459 004 108	380 GTF2/380	Getr. / GBox: R/SR70,71 In 3488 enthalten / Contained in 3488		(31)		
		KF215F	 1888 015 515 #	380 10 GF2/380	Getr. / GBox: SR62 Getr. / GBox: R/SR70 enthält eine Kupplungsscheibe / This part number includes one clutch disc		(66)	
			 1878 000 968 ▽	380 10 380GTZ	Getr. / GBox: SR62 Getr. / GBox: R/SR70 Lose Kupplungsscheibe / Loose clutch disc		(39)	
			 3151 106 041	KZI-5	Getr. / GBox: SR62			
 1882 280 213	380 GF2/380		Getr. / GBox: SR62 Getr. / GBox: R/SR70 In 1888 enthalten / Contained in 1888		(29)			
 1859 212 000	380 GF2/380		Getr. / GBox: SR62 Getr. / GBox: R/SR70 In 1888 enthalten / Contained in 1888		(29)			
 1878 000 965 △	380 10 380GTZ	Getr. / GBox: SR62 Getr. / GBox: R/SR70 In 1888 enthalten / Contained in 1888		(29)				

		CODE				
--	--	------	--	---	---	---

VOLVO























F 12		08.77 - 12.94				
Mot. TD 121, 122, 123	01.83-	KFD214A	 3400 031 033 ⊕  3483 014 132  1878 001 080  1878 001 082  3474 012 000	350 10 GMFZ2/350 350GTZ 350GTZ	Getr. / GBox: R/SR1400, 1700 ohne Zwischenring / without intermediate ring	(105)
			 3488 013 138 ⊕	350 GMFZ2/350	Getr. / GBox: R/SR1400, 1700 enthält eine Kupplungsscheibe / This part number includes one clutch disc	(66)
			 1878 001 082 ▽	350 10 350GTZ	Getr. / GBox: R/SR1400, 1700 Lose Kupplungsscheibe / Loose clutch disc	(39)
			 3482 056 031	350 GMFZ2/350	Getr. / GBox: R/SR1400, 1700 In 3483/3488 enthalten / Contained in 3483, 3488	(30)
			 3459 000 009	350 GMFZ2/350	Getr. / GBox: R/SR1400, 1700 In 3483/3488 enthalten / Contained in 3483, 3488	(30)
			 3100 026 432  3151 000 154  3180 001 008	KZIZ-5 KZISZ-5	Getr. / GBox: R/SR1400, 1700 Beinhaltet Ausrücker und Montagesatz / Contains releaser and fitting kit In 3483/3488 enthalten / Contained in 3483, 3488	(14) (30)
		KFD215A	 3400 030 033 #⊕  3483 017 031  1861 996 137  1861 997 137  3474 012 001	380 10 GMFZ2/380 380GVZ 380GVZ	Getr. / GBox: R/SR1400, 1700 ohne Zwischenring / without intermediate ring	(105)
			 3482 059 031	380 GMFZ2/380	Getr. / GBox: R/SR1400, 1700 In 3483/3488 enthalten / Contained in 3483, 3488	(30)
			 3459 010 101	380 GMFZ2/380	Getr. / GBox: R/SR1400, 1700 In 3483/3488 enthalten / Contained in 3483, 3488	(30)
			 3100 026 432  3151 000 154  3180 001 008	KZIZ-5 KZISZ-5	Getr. / GBox: R/SR1400, 1700 Beinhaltet Ausrücker und Montagesatz / Contains releaser and fitting kit In 3483/3488 enthalten / Contained in 3483, 3488	(14) (30)
			 3488 019 032 ⊕	380 GMFZ2/380	Getr. / GBox: R/SR1400, 1700 enthält eine Kupplungsscheibe / This part number includes one clutch disc	(66)
			 1862 415 031 ▽	380 10 380WGVZ	Getr. / GBox: R/SR1400, 1700 Lose Kupplungsscheibe / Loose clutch disc	(39)
			 3483 027 332 ⊕	380 GMFZ2/380	Getr. / GBox: R/SR1400, 1700 In 3483/3488 enthalten / Contained in 3483, 3488	(30)
			 3482 111 032	380 GMFZ2/380	Getr. / GBox: R/SR1400, 1700 In 3483/3488 enthalten / Contained in 3483, 3488	(30)
 3459 017 031	380 GMFZ2/380	Getr. / GBox: R/SR1400, 1700 In 3488 enthalten / Contained in 3488	(31)			
 1862 248 033 △	380 8 380GVZ	Getr. / GBox: R/SR1400, 1700 In 3488 enthalten / Contained in 3488	(31)			
Mot. TD 122, 123	01.87-	KFD117D	 3400 043 032 ⊕  3483 034 033  1878 634 026	430 10 MFZ430 430WGTZ	Getr. / GBox: R/SR1400, 1700	
			 3482 123 234	430 MFZ430	Getr. / GBox: R/SR1400, 1700 In 3483/3488 enthalten / Contained in 3483, 3488	(30)

VOLVO

F 16		10.87 - 12.94					
Mot. TD 162, 163	01.87-	KFD216A	 3400 116 301  3482 071 131  1878 087 241 x  3100 026 432  3474 012 003	400 10 GMFZ2/400 400GTZ KZIZ-5	->Chass. 382112 Getr. / GBox: SR2000 ohne Zwischenring / without intermediate ring	(105)	
			 3488 016 031	400 GMFZ2/ 400GTZ	->Chass. 382112 Getr. / GBox: SR2000 enthält eine Kupplungsscheibe / This part number includes one clutch disc	(66)	
			 1878 087 241	400 10 400GTZ	->Chass. 382112 Getr. / GBox: SR2000 Lose Kupplungsscheibe / Loose clutch disc	(39)	
			 3459 012 131	400 GMFZ2/400	->Chass. 382112 Getr. / GBox: SR2000 In 3483/3488 enthalten / Contained in 3483, 3488	(30)	
			 3100 026 432  3151 000 154  3180 001 008	KZIZ-5 KZISZ-5	->Chass. 382112 Getr. / GBox: SR2000 Beinhaltet Ausrücker und Montagesatz / Contains releaser and fitting kit In 3483/3488 enthalten / Contained in 3483, 3488	(14) (30)	
Mot. TD 162, 163		KFD216A	 3488 018 031 ⊕	400 GMFZ2/400	Chass. 382113-> Getr. / GBox: SR2000 enthält eine Kupplungsscheibe / This part number includes one clutch disc	(66)	
			 1878 002 458 ▽	400 10 400WGTZ	Chass. 382113-> Getr. / GBox: SR2000 Lose Kupplungsscheibe / Loose clutch disc	(39)	
			 3482 110 031	400 GMFZ2/400	Chass. 382113-> Getr. / GBox: SR2000 In 3488 enthalten / Contained in 3488	(31)	
			 3459 016 031	400 GMFZ2/400	Chass. 382113-> Getr. / GBox: SR2000 In 3488 enthalten / Contained in 3488	(31)	
			 1878 002 460 △	400 10 400GTZ	Chass. 382113-> Getr. / GBox: SR2000 In 3483/3488 enthalten / Contained in 3483, 3488	(30)	
			 3100 026 432  3151 000 154  3180 001 008	KZIZ-5 KZISZ-5	Chass. 382113-> Getr. / GBox: SR2000 Beinhaltet Ausrücker und Montagesatz / Contains releaser and fitting kit In 3483/3488 enthalten / Contained in 3483, 3488	(14) (30)	
F 86							
F 86			 1882 325 134	380 G380	Mot. TD 70 B, E Getr. / GBox: R 51		
			 3151 824 005	KZA-4	Mot. TD 70 B, E Getr. / GBox: R 51		
F 86 über 32 t Gesamtgewicht / from 32t total weight			 1800 125 001  1882 250 143  1878 001 079  1878 001 083  3151 600 533  1874 000 098	350 10 GF2/350 350GTZ 350GTZ KZA-4	Mot. TD 70, E, EF ohne Zwischenring / without intermediate ring	(105)	
			 1888 019 445 #	350 GF2/350	Mot. TD 70, E, EF enthält eine Kupplungsscheibe / This part number includes one clutch disc	(66)	
			 1878 001 083	350 10 350GTZ	Mot. TD 70, E, EF Lose Kupplungsscheibe / Loose clutch disc	(39)	
			 3151 600 533	KZA-4	Mot. TD 70, E, EF		
			 1859 170 204	350 GF2/350	Mot. TD 70, E, EF In 1888 enthalten / Contained in 1888	(29)	







		CODE		 Parameter		
--	--	------	--	---	---	---







VOLVO







F 88							
F 88		<u>1878 000 967</u> ▾	380 10 380GTZ	Mot. TD 100 A Getr. / GBox: MR61 Lose Kupplungsscheibe / Loose clutch disc	(39)		
		<u>3151 106 041</u>	KZI-5	Mot. TD 100 A Getr. / GBox: MR61			
		1882 280 213	380 GF2/380	Mot. TD 100 A Getr. / GBox: MR61 In 1888 enthalten / Contained in 1888	(29)		
		1859 212 000	380 GF2/380	Mot. TD 100 A Getr. / GBox: MR61 In 1888 enthalten / Contained in 1888	(29)		
		1878 000 964 △	380 10 380GTZ	Mot. TD 100 A Getr. / GBox: MR61 In 1888 enthalten / Contained in 1888	(29)		
		<u>1888 019 445</u> #	350 GF2/350	Mot. TD 100, B Getr. / GBox: R 61, SR 61 enthält eine Kupplungsscheibe / This part number includes one clutch disc	(66)		
		<u>1878 001 083</u> ▾	350 10 350GTZ	Mot. TD 100, B Getr. / GBox: R 61, SR 61 Lose Kupplungsscheibe / Loose clutch disc	(39)		
		<u>3151 106 041</u>	KZI-5	Mot. TD 100, B Getr. / GBox: R 61, SR 61			
		1882 250 143	350 GF2/350	Mot. TD 100, B Getr. / GBox: R 61, SR 61 In 1888 enthalten / Contained in 1888	(29)		
		1859 170 204	350 GF2/350	Mot. TD 100, B Getr. / GBox: R 61, SR 61 In 1888 enthalten / Contained in 1888	(29)		
		1878 001 079 △	350 10 350GTZ	Mot. TD 100, B Getr. / GBox: R 61, SR 61 In 1888 enthalten / Contained in 1888	(29)		
		1800 125 601 # • 1882 226 533 • 1861 672 033 • 3151 105 141	420 G420 420GSZ KZI-5	Mot. T 100 A, B; TD 100 A			
	F 88 6x2 LHD		<u>1878 000 967</u> ▾	380 10 380GTZ	Chass. 33995 - Chass. 46790 Mot. TD 100 A Getr. / GBox: R61, SR61 Lose Kupplungsscheibe / Loose clutch disc	(39)	
			<u>3151 106 041</u>	KZI-5	Chass. 33995 - Chass. 46790 Mot. TD 100 A Getr. / GBox: R61, SR61		
		1882 280 213	380 GF2/380	Chass. 33995 - Chass. 46790 Mot. TD 100 A Getr. / GBox: R61, SR61 In 1888 enthalten / Contained in 1888	(29)		
		1859 212 000	380 GF2/380	Chass. 33995 - Chass. 46790 Mot. TD 100 A Getr. / GBox: R61, SR61 In 1888 enthalten / Contained in 1888	(29)		
		1878 000 964 △	380 10 380GTZ	Chass. 33995 - Chass. 46790 Mot. TD 100 A Getr. / GBox: R61, SR61 In 1888 enthalten / Contained in 1888	(29)		
		<u>1888 019 445</u> #	350 GF2/350	Chass. 46791-> für / for: 6x2, 6x4 RHD Mot. TD 100 A enthält eine Kupplungsscheibe / This part number includes one clutch disc	(68) (66)		
		<u>1878 001 083</u> ▾	350 10 350GTZ	Chass. 46791-> für / for: 6x2, 6x4 RHD Mot. TD 100 A Lose Kupplungsscheibe / Loose clutch disc	(68) (39)		
		<u>3151 106 041</u>	KZI-5	Chass. 46791-> für / for: 6x2, 6x4 RHD Mot. TD 100 A	(68)		
		1882 250 143	350 GF2/350	Chass. 46791-> für / for: 6x2, 6x4 RHD Mot. TD 100 A In 1888 enthalten / Contained in 1888	(68) (29)		
		1859 170 204	350 GF2/350	Chass. 46791-> für / for: 6x2, 6x4 RHD Mot. TD 100 A In 1888 enthalten / Contained in 1888	(68) (29)		
		1878 001 079 △	350 10 350GTZ	Chass. 46791-> für / for: 6x2, 6x4 RHD	(68)		

		CODE					
--	--	------	--	--	---	---	---

VOLVO

F 88							
F 88 6x2,6x4 RHD		<u>1878 000 967</u> ▾	380 10 380GTZ	Chass. 33995 - Chass. 40395 Chass. 42121 - Chass. 46790 Mot. TD 100 A Getr. / GBox: R61, SR61 Lose Kupplungsscheibe / Loose clutch disc	(39)		
		<u>3151 106 041</u>	KZI-5	Chass. 33995 - Chass. 40395 Chass. 42121 - Chass. 46790 Mot. TD 100 A Getr. / GBox: R61, SR61			
		1882 280 213	380 GF2/380	Chass. 33995 - Chass. 40395 Chass. 42121 - Chass. 46790 Mot. TD 100 A Getr. / GBox: R61, SR61 In 1888 enthalten / Contained in 1888	(29)		
		1859 212 000	380 GF2/380	Chass. 33995 - Chass. 40395 Chass. 42121 - Chass. 46790 Mot. TD 100 A Getr. / GBox: R61, SR61 In 1888 enthalten / Contained in 1888	(29)		
		1878 000 964 △	380 10 380GTZ	Chass. 33995 - Chass. 40395 Chass. 42121 - Chass. 46790 Mot. TD 100 A Getr. / GBox: R61, SR61 In 1888 enthalten / Contained in 1888	(29)		
F 88 T		1800 125 601 # ● 1882 226 533 ● 1861 672 033 ◊ 3151 105 141	420 G420 420GSZ KZI-5	Chass. 254 - Chass. 269 Chass. 271 - Chass. 298 Chass. 329-> Mot. T 100 A, B; TD 100 A			























F 89							
F 89		1800 125 601 # ● 1882 226 533 ● 1861 672 033 ◊ 3151 105 141	420 G420 420GSZ KZI-5	Mot. TD 110, 120 A			
		<u>1878 000 967</u> ▾	380 10 380GTZ	Mot. TD 120 A Lose Kupplungsscheibe / Loose clutch disc	(39)		
		<u>3151 106 041</u>	KZI-5	Mot. TD 120 A			
		1882 280 213	380 GF2/380	Mot. TD 120 A In 1888 enthalten / Contained in 1888	(29)		
		1859 212 000	380 GF2/380	Mot. TD 120 A In 1888 enthalten / Contained in 1888	(29)		
		1878 000 964 △	380 10 380GTZ	Mot. TD 120 A In 1888 enthalten / Contained in 1888	(29)		

FB - Serie							
FB 86		1882 325 134	380 G380	Mot. TD 70 B, E Getr. / GBox: R 51			
		3151 824 005	KZA-4	Mot. TD 70 B, E Getr. / GBox: R 51			
FB 86 über 32 t Gesamtgewicht / from 32t total weight		1800 125 001 ● 1882 250 143 ● 1878 001 079 ● 1878 001 083 ◊ 3151 600 533 = 1874 000 098	350 10 GF2/350 350GTZ 350GTZ KZA-4	Mot. TD 70, E, EF ohne Zwischenring / without intermediate ring	(105)		
		1888 019 445 #	350 GF2/350	Mot. TD 70, E, EF enthält eine Kupplungsscheibe / This part number includes one clutch disc	(66)		
		<u>1878 001 083</u> ▾	350 10 350GTZ	Mot. TD 70, E, EF Lose Kupplungsscheibe / Loose clutch disc	(39)		
		<u>3151 600 533</u>	KZA-4	Mot. TD 70, E, EF			
		1859 170 204	350 GF2/350	Mot. TD 70, E, EF In 1888 enthalten / Contained in 1888	(29)		





		CODE				
--	--	------	--	---	---	---

VOLVO

FB - Serie

FB 88				1888 019 445 #	350 GF2/350	Mot. TD 100, B Getr. / GBox: R 61, SR 61 enthält eine Kupplungsscheibe / This part number includes one clutch disc	(66)
				1878 001 083 ▾	350 10 350GTZ	Mot. TD 100, B Getr. / GBox: R 61, SR 61 Lose Kupplungsscheibe / Loose clutch disc	(39)
				3151 106 041	KZI-5	Mot. TD 100, B Getr. / GBox: R 61, SR 61	
				1882 250 143	350 GF2/350	Mot. TD 100, B Getr. / GBox: R 61, SR 61 In 1888 enthalten / Contained in 1888	(29)
				1859 170 204	350 GF2/350	Mot. TD 100, B Getr. / GBox: R 61, SR 61 In 1888 enthalten / Contained in 1888	(29)
				1878 001 079 △	350 10 350GTZ	Mot. TD 100, B Getr. / GBox: R 61, SR 61 In 1888 enthalten / Contained in 1888	(29)
				1800 125 601 #  1882 226 533  1861 672 033  3151 105 141	420 G420 420GSZ KZI-5	Mot. T 100A, B ;TD 100A Getr. / GBox: R 61, SR 61	
FB 88 T				1800 125 601 #  1882 226 533  1861 672 033  3151 105 141	420 G420 420GSZ KZI-5	Mot. T 100A, B ;TD 100A Getr. / GBox: R 61, SR 61	
FB 89				1800 125 601 #  1882 226 533  1861 672 033  3151 105 141	420 G420 420GSZ KZI-5	Mot. TD 110, 120 A	
				1878 000 967 ▾	380 10 380GTZ	Mot. TD 120 A Lose Kupplungsscheibe / Loose clutch disc	(39)
				3151 106 041	KZI-5	Mot. TD 120 A	
				1882 280 213	380 GF2/380	Mot. TD 120 A In 1888 enthalten / Contained in 1888	(29)
				1859 212 000	380 GF2/380	Mot. TD 120 A In 1888 enthalten / Contained in 1888	(29)
			1878 000 964 △	380 10 380GTZ	Mot. TD 120 A In 1888 enthalten / Contained in 1888	(29)	



FE 05.06 -





FE 240-18	05.06-	CS39A-O		3400 700 466  3482 634 003  1878 634 034  3151 000 752	395 10 MF395 395WGTZ KZIS-4	
FE 240-18	05.06-					
FE 240-18	05.06-					
FE 240-18	05.06-					
FE 240-22	05.06-					
FE 240-26	05.06-					
FE 240-26	05.06-					
FE 240-26	05.06-					
FE 240-26	05.06-					
FE 240-26	05.06-					
FE 280-18	05.06-					
FE 280-18	05.06-					
FE 280-18	05.06-					
FE 280-18	05.06-					
FE 280-22	05.06-					
FE 280-26	05.06-					
FE 280-26	05.06-					
FE 280-26	05.06-					
FE 280-26	05.06-					
FE 280-26	05.06-					
FE 280-26	05.06-					
FE 280-26	05.06-					











		CODE					
--	--	------	--	--	---	---	---

VOLVO

FE		05.06 -					
FE 320-18	05.06-			3400 700 490 ⊕ 3482 634 005 ⊕ 1878 634 038 ⊕ 3151 000 809	395 10 MF395 395WGTZ KZIS-4		
FE 320-18	05.06-						
FE 320-18	05.06-						
FE 320-18	05.06-						
FE 320-22	05.06-						
FE 320-26	05.06-						
FE 320-26	05.06-						
FE 320-26	05.06-						
FE 320-26	05.06-						
FE 320-26	05.06-						





















FE 6							
Mot. TD 61	01.85-	KB114B		3400 116 201 # ⊕ 3482 909 001 ⊕ 1878 076 031 ⊕ 3151 600 535	350 10 MF350 350GTB KZA-4	Getr. / GBox: S5-35	
		KB114C		3400 116 101 # ⊕ 3482 909 001 ⊕ 1862 974 002 ⊕ 3151 600 534	350 10 MF350 350CPB KZA-4	Getr. / GBox: S5-65	
		KB115C		3400 037 031 ⊕ 3482 021 031 ⊕ 1878 000 961 ⊕ 3151 600 533	380 10 GM380 380GTZ KZA-4	Getr. / GBox: S5-65	

FE 7							
Mot. TD 71, 73	01.85-	KFD117A		3400 035 032 #⊕ ⊕ 3483 034 032 ⊕ 1861 988 034	430 10 MFZ430 430GVZ	Getr. / GBox: R52B	
				3482 123 235	430 MFZ430	Getr. / GBox: R52B In 3483/3488 enthalten / Contained in 3483, 3488	(30)
		KFD117B		3400 040 032 ⊕ ⊕ 3483 034 032 ⊕ 1861 988 040	430 10 MFZ430 430GVZ	Getr. / GBox: R1000	
				3482 123 235	430 MFZ430	Getr. / GBox: R1000 In 3483/3488 enthalten / Contained in 3483, 3488	(30)

FH		09.05 -					
400	09.05-	CS43B-O/OR		3400 700 463 ⊕ ⊕ 3483 000 348 ⊕ 1878 006 129	430 24 MFZ430 430WGTZ	Mot. D13A400, D13B400 Getr. / GBox: VT2214B, VT2514B Getr. / GBox: VTO2214B, VTO2514B	
				1863 869 037	72	Mot. D13A400, D13B400 Getr. / GBox: VT2214B, VT2514B Getr. / GBox: VTO2214B, VTO2514B	
				3400 700 359 ⊕ ⊕ 3482 000 553 ⊕ 1878 006 129	430 24 MF430 430WGTZ	Mot. D13A400, D13B400 Getr. / GBox: AT2412C, AT2512C, Getr. / GBox: ATO2512C	
				3400 700 478 ⊕ ⊕ 3483 000 382 ⊕ 1878 006 129	430 24 MFZ430 430WGTZ	Mot. D13A400, D13B400 Getr. / GBox: VT2009B	
				1863 869 037	72	Mot. D13A400, D13B400 Getr. / GBox: VT2009B	
				3400 700 348 ⊕ ⊕ 3488 019 032 ⊕ 1878 001 216	380 24 GMFZ2/380 380WGVZ	Mot. D13A400, D13B400	
				1863 869 037	72	Mot. D13A400, D13B400	
				3400 700 360 ⊕ ⊕ 3488 000 159 ⊕ 1878 003 768	400 24 MFZ2/400X 400WGTZ	Mot. D13A400, D13B400 für Fahrzeuge mit Zweischeibenkupplung / for vehicles with double disc clutch	(77)
				3400 700 600 ⊕ ⊕ 3483 000 348 ⊕ 1878 007 046	430 24 MFZ430	Mot. D13C Getr. / GBox: VT 2214B / VTO 2214B Getr. / GBox: VT 2514B / VTO 2514B Getr. / GBox: VT 2814B / VTO 2814B Abgasnorm: Euro 6 / Exhaust Emission Norm: Euro 6	(4)
				3400 710 064 ⊕ 3482 001 169 ⊕ 1878 007 170 ⊕ 6482 000 155	430 24 MFZ430 430WGTZ PHIS-6/38	Mot. D13C Getr. / GBox: AT 2412/E /AT 2612/E Getr. / GBox: ATO 2612/E Abgasnorm: Euro 6 / Exhaust Emission Norm: Euro 6	(4)









		CODE				
--	--	------	--	---	---	---







VOLVO

FH		09.05 -						
440	09.05-	CS43B-O/OR		3400 700 463 ⊕ ⊗ 3483 000 348 ⊗ 1878 006 129	430 24 MFZ430 430WGTZ	Mot. D13A440, D13B440 Getr. / GBox: VT2214B, VT2514B Getr. / GBox: VTO2214B, VTO2514B		
440	09.05-			3400 710 061 ⊗ 3482 000 553 ⊗ 1878 006 129 ⤵ 6482 000 155	430 24 MF430 430WGTZ PHIS-6/38	Mot. D13A440, D13B440 Getr. / GBox: AT2412C, AT2512C Getr. / GBox: ATO2512C		
440	09.05-			1863 869 037	72	Mot. D13A440, D13B440 Getr. / GBox: AT2412C, AT2512C Getr. / GBox: ATO2512C		
440	09.05-		CD38B-O		3400 700 348 ⊕ ⊗ 3488 019 032 ⊗ 1878 001 216	380 24 GMFZ2/380 380WGVZ	Mot. D13A440, D13B440 für Fahrzeuge mit Zweischeibenkupplung / for vehicles with double disc clutch	(77)
440	09.05-				1863 869 037	72	Mot. D13A440, D13B440 für Fahrzeuge mit Zweischeibenkupplung / for vehicles with double disc clutch	(77)
440	09.05-			CD40B-O, CL39D-C		3400 700 360 ⊕ ⊗ 3488 000 159 ⊗ 1878 003 768	400 24 MFZ2/400X 400WGTZ	Mot. D13A440, D13B440 für Fahrzeuge mit Zweischeibenkupplung / for vehicles with double disc clutch
440	09.05-				1863 869 037	72	Mot. D13A440, D13B440 für Fahrzeuge mit Zweischeibenkupplung / for vehicles with double disc clutch	(77)
460	01.09-				3400 700 600 ⊕ ⊗ 3483 000 348 ⊗ 1878 007 046	430 24 MFZ430	Mot. D13C Getr. / GBox: VT 2514B / VTO 2514B Getr. / GBox: VT 2814B / VTO 2814B Abgasnorm: Euro 6 / Exhaust Emission Norm: Euro 6	(4)
460	01.09-				3400 710 064 ⊗ 3482 001 169 ⊗ 1878 007 170 ⤵ 6482 000 155	430 24 MFZ430 430WGTZ PHIS-6/38	Mot. D13C Getr. / GBox: AT 2412/E / AT 2612/E Getr. / GBox: ATO 2612/E Abgasnorm: Euro 6 / Exhaust Emission Norm: Euro 6	(4)
460	01.09-			3400 700 600 ⊕ ⊗ 3483 000 348 ⊗ 1878 007 046	430 24 MFZ430	Mot. D13K Getr. / GBox: VT 2814B / VTO 2814B Abgasnorm: Euro 6 / Exhaust Emission Norm: Euro 6	(4)	
460	01.09-			3400 710 064 ⊗ 3482 001 169 ⊗ 1878 007 170 ⤵ 6482 000 155	430 24 MFZ430 430WGTZ PHIS-6/38	Mot. D13K Getr. / GBox: ATO 2612/E Getr. / GBox: AT 2412/E / AT 2612/E Abgasnorm: Euro 6 / Exhaust Emission Norm: Euro 6	(4)	
480	09.05-	CS43B-O/OR			3400 700 463 ⊕ ⊗ 3483 000 348 ⊗ 1878 006 129	430 24 MFZ430 430WGTZ	Mot. D13A480 Getr. / GBox: VT2214B, VT2514B Getr. / GBox: VTO2214B, VTO2514B	
480	09.05-				3400 710 061 ⊗ 3482 000 553 ⊗ 1878 006 129 ⤵ 6482 000 155	430 24 MF430 430WGTZ PHIS-6/38	Mot. D13A480 Getr. / GBox: AT2412C, AT2512C Getr. / GBox: ATO2512C	
480	09.05-			1863 869 037	72	Mot. D13A480 Getr. / GBox: AT2412C, AT2512C Getr. / GBox: ATO2512C		
480	09.05-		CD38B-O		3400 700 348 ⊕ ⊗ 3488 019 032 ⊗ 1878 001 216	380 24 GMFZ2/380 380WGVZ	Mot. D13A480 für Fahrzeuge mit Zweischeibenkupplung / for vehicles with double disc clutch	(77)
480	09.05-				1863 869 037	72	Mot. D13A480 für Fahrzeuge mit Zweischeibenkupplung / for vehicles with double disc clutch	(77)
480	09.05-			CD40B-O, CL39D-C		3400 700 360 ⊕ ⊗ 3488 000 159 ⊗ 1878 003 768	400 24 MFZ2/400X 400WGTZ	Mot. D13A480 für Fahrzeuge mit Zweischeibenkupplung / for vehicles with double disc clutch
480	09.05-				1863 869 037	72	Mot. D13A480 für Fahrzeuge mit Zweischeibenkupplung / for vehicles with double disc clutch	(77)
500	01.09-				3400 700 600 ⊕ ⊗ 3483 000 348 ⊗ 1878 007 046	430 24 MFZ430	Mot. D13C Getr. / GBox: VT 2514B / VTO 2514B Getr. / GBox: VT 2814B / VTO 2814B Abgasnorm: Euro 6 / Exhaust Emission Norm: Euro 6	(4)
500	01.09-				3400 710 064 ⊗ 3482 001 169 ⊗ 1878 007 170 ⤵ 6482 000 155	430 24 MFZ430 430WGTZ PHIS-6/38	Mot. D13C Getr. / GBox: AT2612/E / ATO2612/E Abgasnorm: Euro 6 / Exhaust Emission Norm: Euro 6	(4)

		CODE				
--	--	------	--	---	---	---













VOLVO

FH		09.05 -						
520	09.05-	CS43B-O/OR		3400 700 463 ⊕ ⊗ 3483 000 348 ⊗ 1878 006 129	430 24 MFZ430 430WGTZ	Mot. D13A520 Getr. / GBox: VT2214B, VT2514B Getr. / GBox: VTO2214B, VTO2514B		
520	09.05-			3400 710 061 ⊗ 3482 000 553 ⊗ 1878 006 129 ⊗ 6482 000 155	430 24 MF430 430WGTZ PHIS-6/38	Mot. D13A520 Getr. / GBox: AT2412C, AT2512C Getr. / GBox: ATO2512C		
520	09.05-			1863 869 037	72	Mot. D13A520 Getr. / GBox: AT2412C, AT2512C Getr. / GBox: ATO2512C		
520	09.05-		CD38B-O		3400 700 348 ⊕ ⊗ 3488 019 032 ⊗ 1878 001 216	380 24 GMFZ2/380 380WGVZ	Mot. D13A520 für Fahrzeuge mit Zweischeibenkupplung / for vehicles with double disc clutch	(77)
520	09.05-				1863 869 037	72	Mot. D13A520 für Fahrzeuge mit Zweischeibenkupplung / for vehicles with double disc clutch	(77)
520	09.05-		CD40B-O, CL39D-C		3400 700 360 ⊕ ⊗ 3488 000 159 ⊗ 1878 003 768	400 24 MFZ2/400X 400WGTZ	Mot. D13A520 für Fahrzeuge mit Zweischeibenkupplung / for vehicles with double disc clutch	(77)
520	09.05-			1863 869 037	72	Mot. D13A520 für Fahrzeuge mit Zweischeibenkupplung / for vehicles with double disc clutch	(77)	
540	01.09-			3400 700 600 ⊕ ⊗ 3483 000 348 ⊗ 1878 007 046	430 24 MFZ430	Mot. D13C Getr. / GBox: VT 2814B / VTO 2814B Abgasnorm: Euro 6 / Exhaust Emission Norm: Euro 6	(4)	
540	01.09-			3400 710 064 ⊗ 3482 001 169 ⊗ 1878 007 170 ⊗ 6482 000 155	430 24 MFZ430 430WGTZ PHIS-6/38	Mot. D13C Getr. / GBox: AT2612/E / ATO2612/E Abgasnorm: Euro 6 / Exhaust Emission Norm: Euro 6	(4)	

FH 12		08.93 -					
Mot. D 12 A	01.93-	CL43S-0		3400 043 032 ⊕ ⊗ 3483 034 033 ⊗ 1878 634 026	430 10 MFZ430 430WGTZ	Getr. / GBox: R/SR1700,1900	
				3482 123 234	430 MFZ430	Getr. / GBox: R/SR1700,1900 In 3483/3488 enthalten / Contained in 3483, 3488	(30)
		CL38D-0		3400 700 426 ⊕ ⊗ 3488 019 031 ⊗ 1862 415 031	380 10 GMFZ2/380 380WGVZ	Getr. / GBox: R/SR1700,1900	
				3400 700 325 ⊕ ⊗ 3483 027 231 ⊗ 1862 248 033 ⊗ 1862 415 031	380 10 GMFZ2/380 380GVZ 380WGVZ	Getr. / GBox: R/SR1700,1900 ohne Zwischenring / without intermediate ring	(105)
				3482 111 031	380 GMFZ2/380	Getr. / GBox: R/SR1700,1900 In 3483/3488 enthalten / Contained in 3483, 3488	(30)
				3459 017 031	380 GMFZ2/380	Getr. / GBox: R/SR1700,1900 In 3488 enthalten / Contained in 3488	(31)























		CODE				
--	--	------	--	---	---	---

VOLVO

FH 12		08.93 -						
FH 12/340	08.93-	CL38D-O		3400 700 426 ⊕ ⊗ 3488 019 031 ⊗ 1862 415 031	380 10 GMFZ2/380 380WGVZ	Mot. D12A Getr. / GBox: R/SR1700/1900		
FH 12/340	08.93-			3400 700 325 ⊕ ⊗ 3483 027 231 ⊗ 1862 248 033 1862 415 031	380 10 GMFZ2/380 380GVZ 380WGVZ	Mot. D12A Getr. / GBox: R/SR1700/1900 ohne Zwischenring / without intermediate ring	(105)	
FH 12/340	01.95-			3482 111 031	380 GMFZ2/380	Mot. D12A Getr. / GBox: R/SR1700/1900 In 3483/3488 enthalten / Contained in 3483, 3488	(30)	
FH 12/340	08.93-			3459 017 031	380 GMFZ2/380	Mot. D12A Getr. / GBox: R/SR1700/1900 In 3488 enthalten / Contained in 3488	(31)	
FH 12/340	08.93-			3400 700 427 ⊕ ⊗ 3488 019 032 ⊗ 1862 415 031	380 10 GMFZ2/380 380WGVZ	Mot. D12C Getr. / GBox: R/SR1700/1900		
FH 12/340	08.93-			3400 700 326 ⊕ ⊗ 3483 027 332 ⊗ 1862 248 033 1862 415 031	380 10 GMFZ2/380 380GVZ 380WGVZ	Mot. D12C Getr. / GBox: R/SR1700/1900 ohne Zwischenring / without intermediate ring	(105)	
FH 12/340	08.93-			3482 111 032	380 GMFZ2/380	Mot. D12C Getr. / GBox: R/SR1700/1900 In 3483/3488 enthalten / Contained in 3483, 3488	(30)	
FH 12/340	08.93-			3459 017 031	380 GMFZ2/380	Mot. D12C Getr. / GBox: R/SR1700/1900 In 3488 enthalten / Contained in 3488	(31)	
FH 12/340	08.93-		CL43S-O		3400 127 101 ⊕ ⊗ 3483 034 034 ⊗ 1878 634 026	430 10 MFZ430 430WGTZ	Mot. D12C Getr. / GBox: VT2014, VT2014OD	
FH 12/340	08.93-				3482 123 234	430 MFZ430	Mot. D12C Getr. / GBox: VT2014, VT2014OD In 3483/3488 enthalten / Contained in 3483, 3488	(30)
FH 12/340	08.93-			3400 043 032 ⊕ ⊗ 3483 034 033 ⊗ 1878 634 026	430 10 MFZ430 430WGTZ	Mot. D12A,C Getr. / GBox: R/SR1700/1900		
FH 12/340	08.93-			3482 123 234	430 MFZ430	Mot. D12A,C Getr. / GBox: R/SR1700/1900 In 3483/3488 enthalten / Contained in 3483, 3488	(30)	

		CODE				
--	--	------	--	---	---	---

VOLVO

FH 12		08.93 -				
FH 12/420	08.93-	CD38B-O	 3400 700 348 ⊕ ⊗ 3488 019 032 ⊗ 1878 001 216	380 24 GMFZ2/380 380WGVZ	Mot. D12D420 Getr. / GBox: VT2009B	
FH 12/420	08.93-	CL39D-C	 3400 700 360 ⊕ ⊗ 3488 000 159 ⊗ 1878 003 768	400 24 MFZ2/400X 400WGTZ		
FH 12/420	01.95-					
FH 12/420	08.93-	CD40B-O	 3400 700 422 ⊕ ⊗ 3488 000 024 ⊗ 1878 000 300	400 24 MFZ2/400X 400WGTZ	Mot. D12D420 Getr. / GBox: VT2214B, VTO2214B mit Zwischenring / with intermediate ring	(95)
FH 12/420	08.93-		 3400 700 423 ⊕ ⊗ 3483 034 135 ⊗ 1878 000 300 1878 000 635	400 24 MFZ2/400X 400WGTZ 400GTZ	Mot. D12D420 Getr. / GBox: VT2214B, VTO2214B ohne Zwischenring / without intermediate ring	(105)
FH 12/420	08.93-	CL38D-O	 3400 700 426 ⊕ ⊗ 3488 019 031 ⊗ 1862 415 031	380 10 GMFZ2/380 380WGVZ	Mot. D12A Getr. / GBox: R/SR1700/1900	
FH 12/420	08.93-		 3400 700 325 ⊕ ⊗ 3483 027 231 ⊗ 1862 248 033 1862 415 031	380 10 GMFZ2/380 380GVZ 380WGVZ	Mot. D12A Getr. / GBox: R/SR1700/1900 ohne Zwischenring / without intermediate ring	(105)
FH 12/420	08.93-		 3400 700 427 ⊕ ⊗ 3488 019 032 ⊗ 1862 415 031	380 10 GMFZ2/380 380WGVZ	Mot. D12C Getr. / GBox: R/SR1700/1900	
FH 12/420	08.93-		 3400 700 326 ⊕ ⊗ 3483 027 332 ⊗ 1862 248 033 1862 415 031	380 10 GMFZ2/380 380GVZ 380WGVZ	Mot. D12C Getr. / GBox: R/SR1700/1900 ohne Zwischenring / without intermediate ring	(105)
FH 12/420	08.93-	CS43B-O	 3400 700 350 ⊕ ⊗ 3483 034 042 ⊗ 1878 000 634	430 24 MFZ430 430WGTZ	Mot. D12D420 Getr. / GBox: VT2412B	
FH 12/420	08.93-	CL43S-O	 3400 127 101 ⊕ ⊗ 3483 034 034 ⊗ 1878 634 026	430 10 MFZ430 430WGTZ	Mot. D12C Getr. / GBox: VT2014, VT2014OD	
FH 12/420	08.93-		 3400 043 032 ⊕ ⊗ 3483 034 033 ⊗ 1878 634 026	430 10 MFZ430 430WGTZ	Mot. D12A,C Getr. / GBox: R/SR1700/1900	
FH 12/420	08.93-	CS43B-O, CS43B-OR	 3400 700 343 ⊕ ⊗ 3483 034 034 ⊗ 1878 000 634	430 24 MFZ430 430WGTZ	Mot. D12D420 Getr. / GBox: VT2214B, VTO2214B	
FH 12/420	08.93-		 3400 700 342 ⊕ ⊗ 3483 034 033 ⊗ 1878 000 634	430 24 MFZ430 430WGTZ	Mot. D12D420 Getr. / GBox: VT2009B	
FH 12/460	08.98-	CL39D-C	 3400 700 360 ⊕ ⊗ 3488 000 159 ⊗ 1878 003 768	400 24 MFZ2/400X 400WGTZ		
FH 12/460	08.98-	CD40B-O	 3400 700 422 ⊕ ⊗ 3488 000 024 ⊗ 1878 000 300	400 24 MFZ2/400X 400WGTZ	Mot. D12D460 Getr. / GBox: VT2514B, VTO2514B mit Zwischenring / with intermediate ring	(95)
FH 12/460	08.98-		 3400 700 423 ⊕ ⊗ 3483 034 135 ⊗ 1878 000 300 1878 000 635	400 24 MFZ2/400X 400WGTZ 400GTZ	Mot. D12D460 Getr. / GBox: VT2514B, VTO2514B ohne Zwischenring / without intermediate ring	(105)
FH 12/460	08.98-		 3459 018 004	400 MFZ2/400X	Mot. D12D460 Getr. / GBox: VT2514B, VTO2514B In 3488 enthalten / Contained in 3488	(31)
FH 12/460	08.98-	CL40D-O	 3400 700 406 ⊕ ⊗ 3488 022 253 ⊗ 1878 002 437	400 10 MFZ2/400X 400WGTZ	Mot. D12C460 mit Zwischenring / with intermediate ring	(95)
FH 12/460	08.98-	CS43B-O	 3400 700 351 ⊕ ⊗ 3483 034 043 ⊗ 1878 006 129	430 24 MFZ430 430WGTZ	Mot. D12D460 Getr. / GBox: VT2412B	
FH 12/460	08.98-		 3400 700 357 ⊕ ⊗ 3483 034 035 ⊗ 1878 006 129	430 24 MFZ430 430WGTZ	Mot. D12D460 Getr. / GBox: VT2514B	
FH 12/460	08.98-	CL43S-O	 3400 700 401 ⊕ ⊗ 3483 034 035 ⊗ 1878 032 331	430 10 MFZ430 430WGTZ	Mot. D12C460 Getr. / GBox: VT2514	
FH 12/460	08.98-		 3400 127 101 ⊕ ⊗ 3483 034 034 ⊗ 1878 634 026	430 10 MFZ430 430WGTZ	Mot. D12C Getr. / GBox: VT2014, VT2014OD	
FH 12/460	08.98-		 3482 123 234	430 MFZ430	Mot. D12C Getr. / GBox: VT2014, VT2014OD In 3483/3488 enthalten / Contained in 3483, 3488	(30)















VOLVO

FH 12		08.93 -					
FH 12/500	09.01 -	CL39D-C		3400 700 360 ⊕ Ⓢ 3488 000 159 Ⓢ 1878 003 768	400 24 MFZ2/400X 400WGTZ		
		CD40B-O		3400 700 422 ⊕ Ⓢ 3488 000 024 Ⓢ 1878 000 300	400 24 MFZ2/400X 400WGTZ	Mot. D12D500 Getr. / GBox: VT2514B, VTO2514B mit Zwischenring / with intermediate ring	(95)
				3400 700 423 ⊕ Ⓢ 3483 034 135 Ⓢ 1878 000 300 Ⓢ 1878 000 635	400 24 MFZ2/400X 400WGTZ 400GTZ	Mot. D12D500 Getr. / GBox: VT2514B, VTO2514B ohne Zwischenring / without intermediate ring	(105)
				3459 018 004	400 MFZ2/400X	Mot. D12D500 Getr. / GBox: VT2514B, VTO2514B In 3488 enthalten / Contained in 3488	(31)
		CS43B-O		3400 700 351 ⊕ Ⓢ 3483 034 043 Ⓢ 1878 006 129	430 24 MFZ430 430WGTZ	Mot. D12D500 Getr. / GBox: VT2412B	















		CODE				
--	--	------	--	---	---	---

VOLVO

FH 16		08.93 -					
FH 16/470 6x4	08.93-	CL40D-O		3488 018 031 ⊕	400 GMFZ2/400	->Chass. A291151 ->Chass. B21584 ->Chass. D120646 Mot. D16A470,D16B470 enthält eine Kupplungsscheibe / This part number includes one clutch disc	(66)
FH 16/470	08.93-12.99						
FH 16/470	08.93-12.99						
FH 16/470 4x2	08.93-						
FH 16/470 4x2	08.93-						
FH 16/470	08.93-12.99			1878 002 458 ▽	400 10 400WGTZ	->Chass. A291151 ->Chass. B21584 ->Chass. D120646 Mot. D16A470,D16B470 Lose Kupplungsscheibe / Loose clutch disc	(39)
FH 16/470 6x2	01.95-						
FH 16/470	08.93-12.99						
FH 16/470	08.93-12.99						
FH 16/470 6x2	08.93-			3482 110 031	400 GMFZ2/400	->Chass. A291151 ->Chass. B21584 ->Chass. D120646 Mot. D16A470,D16B470 In 3488 enthalten / Contained in 3488	(31)
FH 16/470 6x2/2/4	08.93-						
FH 16/470 6x4	08.93-			3459 016 031	400 GMFZ2/400	->Chass. A291151 ->Chass. B21584 ->Chass. D120646 Mot. D16A470,D16B470 In 3488 enthalten / Contained in 3488	(31)
				1878 002 460 △	400 10 400GTZ	->Chass. A291151 ->Chass. B21584 ->Chass. D120646 Mot. D16A470,D16B470 In 3483/3488 enthalten / Contained in 3483, 3488	(30)
				3400 700 406 ⊕ ⊕ 3488 022 253 ⊕ 1878 002 437	400 10 MFZ2/400X 400WGTZ	Chass. A291152-> Chass. B21585-> Chass. D120647-> Mot. D16A470,D16B470 mit Zwischenring / with intermediate ring	(95)
				3459 018 004	400 MFZ2/400X	Chass. A291152-> Chass. B21585-> Chass. D120647-> Mot. D16A470,D16B470 In 3488 enthalten / Contained in 3488	(31)
				3400 700 407 ⊕ ⊕ 3483 034 135 ⊕ 1878 002 437 1878 002 442	400 10 MFZ2/400X 400WGTZ 400GTZ	Chass. A291152-> Chass. B21585-> Chass. D120647-> Mot. D16A470,D16B470 ohne Zwischenring / without intermediate ring	(105)
				3488 018 031 ⊕	400 GMFZ2/400	Chass. C750800-> Mot. D16A470,D16B470 Länderausführung: Groß Britannien / Country Version: Great Britain enthält eine Kupplungsscheibe / This part number includes one clutch disc	(40) (66)
				1878 002 458 ▽	400 10 400WGTZ	Chass. C750800-> Mot. D16A470,D16B470 Länderausführung: Groß Britannien / Country Version: Great Britain Lose Kupplungsscheibe / Loose clutch disc	(40) (39)
				3482 110 031	400 GMFZ2/400	Chass. C750800-> Mot. D16A470,D16B470 Länderausführung: Groß Britannien / Country Version: Great Britain In 3488 enthalten / Contained in 3488	(40) (31)
				3459 016 031	400 GMFZ2/400	Chass. C750800-> Mot. D16A470,D16B470 Länderausführung: Groß Britannien / Country Version: Great Britain In 3488 enthalten / Contained in 3488	(40) (31)
				1878 002 460 △	400 10 400GTZ	Chass. C750800-> Mot. D16A470,D16B470 Länderausführung: Groß Britannien / Country Version: Great Britain In 3483/3488 enthalten / Contained in 3483, 3488	(40) (30)





















		CODE				
--	--	------	--	---	---	---

VOLVO

FH 16		08.93 -						
FH 16/520	08.93-12.02	CL40D-O		3488 018 031 ⊕	400 GMFZ2/400	->Chass. A291151 ->Chass. B21584 ->Chass. D120646 Mot. D16A520,D16B520 enthält eine Kupplungsscheibe / This part number includes one clutch disc	(66)	
FH 16/520	08.93-12.02			1878 002 458 ▽	400 10 400WGTZ	->Chass. A291151 ->Chass. B21584 ->Chass. D120646 Mot. D16A520,D16B520 Lose Kupplungsscheibe / Loose clutch disc	(39)	
FH 16/520	01.95-							
FH 16/520	08.93-12.02							
FH 16/520	08.93-12.02							
FH 16/520	08.93-12.02							
FH 16/520	08.93-12.02							
FH 16/520	08.93-12.02							
					3482 110 031	400 GMFZ2/400	->Chass. A291151 ->Chass. B21584 ->Chass. D120646 Mot. D16A520,D16B520 In 3488 enthalten / Contained in 3488	(31)
					3459 016 031	400 GMFZ2/400	->Chass. A291151 ->Chass. B21584 ->Chass. D120646 Mot. D16A520,D16B520 In 3488 enthalten / Contained in 3488	(31)
					1878 002 460 △	400 10 400GTZ	->Chass. A291151 ->Chass. B21584 ->Chass. D120646 Mot. D16A520,D16B520 In 3483/3488 enthalten / Contained in 3483, 3488	(30)
					3400 700 406 ⊕ ⊕ 3488 022 253 ⊕ 1878 002 437	400 10 MFZ2/400X 400WGTZ	Chass. A291152-> Chass. B21585-> Chass. D120647-> Mot. D16A520,D16B520 mit Zwischenring / with intermediate ring	(95)
					3459 018 004	400 MFZ2/400X	Chass. A291152-> Chass. B21585-> Chass. D120647-> Mot. D16A520,D16B520 In 3488 enthalten / Contained in 3488	(31)
					3400 700 407 ⊕ ⊕ 3483 034 135 ⊕ 1878 002 437 1878 002 442	400 10 MFZ2/400X 400WGTZ 400GTZ	Chass. A291152-> Chass. B21585-> Chass. D120647-> Mot. D16A520,D16B520 ohne Zwischenring / without intermediate ring	(105)
					3488 018 031 ⊕	400 GMFZ2/400	Chass. C750800-> Mot. D16A520,D16B520 Länderausführung: Groß Britannien / Country Version: Great Britain enthält eine Kupplungsscheibe / This part number includes one clutch disc	(40) (66)
				1878 002 458 ▽	400 10 400WGTZ	Chass. C750800-> Mot. D16A520,D16B520 Länderausführung: Groß Britannien / Country Version: Great Britain Lose Kupplungsscheibe / Loose clutch disc	(40) (39)	
				3482 110 031	400 GMFZ2/400	Chass. C750800-> Mot. D16A520,D16B520 Länderausführung: Groß Britannien / Country Version: Great Britain In 3488 enthalten / Contained in 3488	(40) (31)	
				3459 016 031	400 GMFZ2/400	Chass. C750800-> Mot. D16A520,D16B520 Länderausführung: Groß Britannien / Country Version: Great Britain In 3488 enthalten / Contained in 3488	(40) (31)	
				1878 002 460 △	400 10 400GTZ	Chass. C750800-> Mot. D16A520,D16B520 Länderausführung: Groß Britannien / Country Version: Great Britain In 3483/3488 enthalten / Contained in 3483, 3488	(40) (30)	
FH 16/540				3400 710 065 ⊕ 3482 001 165 ⊕ 1878 007 169 ⊕ 6482 000 155	430 24 MFZ430 430WGTZ PHIS-6/38	Mot. D16G Getr. / GBox: AT2812/D / ATO3112/D Abgasnorm: Euro 6 / Exhaust Emission Norm: Euro 6 für Motoren ohne Zweimassenschwungrad / for engines without dual-mass flywheel	(4) (81)	

		CODE				
--	--	------	--	---	---	---



VOLVO

FH 16		08.93 -					
FH 16/540, FH 16/550 FH 16/540, FH 16/550 FH 16/540, FH 16/550 FH 16/540, FH 16/550 FH 16/540, FH 16/550 FH 16/540, FH 16/550 FH 16/540, FH 16/550	01.03-	CS43B-O	 3400 710 063 ■ ⊗ 3482 000 865 ⊗ 1878 003 869 ↘ 6482 000 171	430 24 MFZ430E 430GTZ PHIS-6/30	XTend Kit plus CSC Mot. D16E540, D16C550 Getr. / GBox: AT2812C, ATO3112C		
	01.03-		 6594 000 120	430 430Z		Mot. D16E540, D16C550 Getr. / GBox: AT2812C, ATO3112C nur in Verbindung mit / only in connection with: OE.Nr. 975154	(101)
	01.03-		 1863 869 037	72		Mot. D16E540, D16C550 Getr. / GBox: AT2812C, ATO3112C	
		01.03-	CD40B-O	 3400 700 360 ⊕ ⊗ 3488 000 159 ⊗ 1878 003 768	400 24 MFZ2/400X 400WGTZ	für / for: Abgas Japannorm 2004 Mot. D16E540, D16C550 Getr. / GBox: VT2814B, VTO2814B	(68)
				 3400 700 422 ⊕ ⊗ 3488 000 024 ⊗ 1878 000 300	400 24 MFZ2/400X 400WGTZ	Mot. D16E540, D16C550 Getr. / GBox: VT2814B, VTO2814B mit Zwischenring / with intermediate ring	(95)
				 1863 869 037	72	Mot. D16E540, D16C550 Getr. / GBox: VT2814B, VTO2814B	
FH 16/580 FH 16/580 FH 16/580 FH 16/580 FH 16/580 FH 16/580 FH 16/580	09.06-	CS43B-O	 3400 710 063 ■ ⊗ 3482 000 865 ⊗ 1878 003 869 ↘ 6482 000 171	430 24 MFZ430E 430GTZ PHIS-6/30	XTend Kit plus CSC Mot. D16E580 Getr. / GBox: AT2812C, ATO3112C		
	09.06-		 6594 000 120	430 430Z		Mot. D16E580 Getr. / GBox: AT2812C, ATO3112C nur in Verbindung mit / only in connection with: OE.Nr. 975154	(101)
	09.06-		 1863 869 037	72		Mot. D16E580 Getr. / GBox: AT2812C, ATO3112C	
		09.06-	CD40B-O	 3400 700 360 ⊕ ⊗ 3488 000 159 ⊗ 1878 003 768	400 24 MFZ2/400X 400WGTZ	für / for: Abgas Japannorm 2004 Mot. D16E580 Getr. / GBox: VT2814B, VTO2814B	(68)
				 3400 700 422 ⊕ ⊗ 3488 000 024 ⊗ 1878 000 300	400 24 MFZ2/400X 400WGTZ	Mot. D16E580 Getr. / GBox: VT2814B, VTO2814B mit Zwischenring / with intermediate ring	(95)
				 1863 869 037	72	Mot. D16E580 Getr. / GBox: VT2814B, VTO2814B	
FH 16/610 FH 16/610 FH 16/610 FH 16/610 FH 16/610 FH 16/610 FH 16/610	01.03-	CS43B-O	 3400 710 063 ■ ⊗ 3482 000 865 ⊗ 1878 003 869 ↘ 6482 000 171	430 24 MFZ430E 430GTZ PHIS-6/30	XTend Kit plus CSC Mot. D16C610 Getr. / GBox: AT2812C, ATO3112C		
	01.03-		 6594 000 120	430 430Z		Mot. D16C610 Getr. / GBox: AT2812C, ATO3112C nur in Verbindung mit / only in connection with: OE.Nr. 975154	(101)
	01.03-		 1863 869 037	72		Mot. D16C610 Getr. / GBox: AT2812C, ATO3112C	
		01.03-	CD40B-O	 3400 700 360 ⊕ ⊗ 3488 000 159 ⊗ 1878 003 768	400 24 MFZ2/400X 400WGTZ	für / for: Abgas Japannorm 2004 Mot. D16C610 Getr. / GBox: VT2814B, VTO2814B	(68)
				 3400 700 422 ⊕ ⊗ 3488 000 024 ⊗ 1878 000 300	400 24 MFZ2/400X 400WGTZ	Mot. D16C610 Getr. / GBox: VT2814B, VTO2814B mit Zwischenring / with intermediate ring	(95)
				 1863 869 037	72	Mot. D16C610 Getr. / GBox: VT2814B, VTO2814B	
FH 16/660 FH 16/660 FH 16/660 FH 16/660 FH 16/660 FH 16/660 FH 16/660	09.06-	CS43B-O	 3400 710 063 ■ ⊗ 3482 000 865 ⊗ 1878 003 869 ↘ 6482 000 171	430 24 MFZ430E 430GTZ PHIS-6/30	XTend Kit plus CSC Mot. D16E660 Getr. / GBox: AT2812C, ATO3112C		
	09.06-		 6594 000 120	430 430Z		Mot. D16E660 Getr. / GBox: AT2812C, ATO3112C nur in Verbindung mit / only in connection with: OE.Nr. 975154	(101)
	09.06-		 1863 869 037	72		Mot. D16E660 Getr. / GBox: AT2812C, ATO3112C	
		09.06-					
FH 16/700 FH 16/750			 3400 710 065 ⊗ 3482 001 165 ⊗ 1878 007 169 ↘ 6482 000 155	430 24 MFZ430 430WGTZ PHIS-6/38	Mot. D16G Getr. / GBox: ATO 3112/D Abgasnorm: Euro 6 / Exhaust Emission Norm: Euro 6 für Motoren ohne Zweimassenschwungrad / for engines without dual-mass flywheel	(4) (81)	









		CODE					
--	--	------	--	--	---	---	---

VOLVO

FH 565 / NH 565













































FH 565 / NH 565		CL40D-O		3400 700 406 ⊕ ⊕ 3488 022 253 ⊕ 1878 002 437	400 10 MFZ2/400X 400WGTZ	mit Zwischenring / with intermediate ring	(95)
				3400 700 407 ●⊕ ⊕ 3483 034 135 ⊕ 1878 002 437 ⊕ 1878 002 442	400 10 MFZ2/400X 400WGTZ 400GTZ	ohne Zwischenring / without intermediate ring	(105)
				3459 018 004	400 MFZ2/400X	In 3488 enthalten / Contained in 3488	(31)

FL 6 09.85 - 03.00

































FL 180 FL 205G FL 220 FL 250	06.00 - 06.00 - 06.00 - 06.00 -	KB114E/F		3482 602 005	350 350	Chass. 1921636 - Chass. 1921928 Chass. 2921849 - Chass. 2929187 Chass. B265000-> Chass. S921941->	
				1878 600 557	350 10 350	Chass. 1921636 - Chass. 1921928 Chass. 2921849 - Chass. 2929187 Chass. B265000-> Chass. S921941->	
		KB114G		3482 602 006	350 350	Chass. 1921636 - Chass. 1921928 Chass. 2921849 - Chass. 2929187 Chass. B265000-> Chass. S921941->	
				1878 600 557	350 10 350	Chass. 1921636 - Chass. 1921928 Chass. 2921849 - Chass. 2929187 Chass. B265000-> Chass. S921941->	
		KB115		3482 602 002	380 M380	Chass. 1921636 - Chass. 1921928 Chass. 2921849 - Chass. 2929187 Chass. B265000-> Chass. S921941->	
				1878 000 961	380 10 380GTZ	Chass. 1921636 - Chass. 1921928 Chass. 2921849 - Chass. 2929187 Chass. B265000-> Chass. S921941->	
		KB115A		3482 602 003	380 380	Chass. 1921636 - Chass. 1921928 Chass. 2921849 - Chass. 2929187 Chass. B265000-> Chass. S921941->	
				1878 000 961	380 10 380GTZ	Chass. 1921636 - Chass. 1921928 Chass. 2921849 - Chass. 2929187 Chass. B265000-> Chass. S921941->	

		CODE		 Parameter		
--	--	------	--	---	---	---

VOLVO













FL 6		09.85 - 03.00				
FL 608	10.85 - 12.99	KB113C	 3400 116 001  3482 905 001  1862 973 002  3151 600 533	330 10 MF330 330CPB KZA-4	->Chass. 495167 ->Chass. B166079 ->Chass. 1920500	
FL 608	10.85 - 12.99		KB114C	 3400 116 101 #  3482 909 001  1862 974 002  3151 600 534	350 10 MF350 350CPB KZA-4	->Chass. 495167 ->Chass. B166079 ->Chass. 1920500
FL 608	01.91 - 12.99			3482 909 001 #	350 MF350	Chass. B166080 - Chass. B264999 Chass. 1920501 - Chass. 1920635
FL 608	01.91 - 12.99	3151 600 534			KZA-4	Chass. B166080 - Chass. B264999 Chass. 1920501 - Chass. 1920635
FL 608	01.93 - 12.99	KB114B/D		 3400 116 201 #  3482 909 001  1878 076 031  3151 600 535	350 10 MF350 350GTB KZA-4	->Chass. 495167 ->Chass. B166079 ->Chass. 1920500 Getr. / GBox: S5-35
FL 608	01.93 - 12.99			KB114B	 3482 909 001 #	350 MF350
FL 610	09.85 - 11.94	 1878 600 563			350 10 350	Chass. B166080 - Chass. B264999 Chass. 1920501 - Chass. 1920635
FL 611	09.85 - 11.94	 3151 600 534	KZA-4		Chass. B166080 - Chass. B264999 Chass. 1920501 - Chass. 1920635	
FL 611	09.85 - 03.00	KB114D	 3482 602 008	350 350	Chass. B166080 - Chass. B264999	
FL 611	09.85 - 03.00		 1878 600 563	350 10 350	Chass. B166080 - Chass. B264999	
FL 611	09.85 - 03.00		 3151 600 534	KZA-4	Chass. B166080 - Chass. B264999	
FL 611	12.94 - 03.00	KB115, KV115B	 3400 037 031  3482 021 031  1878 000 961  3151 600 533	380 10 GM380 380GTZ KZA-4	->Chass. 495167 ->Chass. B166079 ->Chass. 1920500	
FL 612	09.85 - 12.99		KB115	 3482 602 002	380 M380	Chass. B166080 - Chass. B264999 Chass. 1920501 - Chass. 1920635
FL 612	11.91 - 12.99			 1878 000 961	380 10 380GTZ	Chass. B166080 - Chass. B264999 Chass. 1920501 - Chass. 1920635
FL 612	11.91 - 12.99	KB115A	 3151 600 533	KZA-4	Chass. B166080 - Chass. B264999 Chass. 1920501 - Chass. 1920635	
FL 612	12.95 - 12.99		 3482 602 003	380 380	Chass. B166080 - Chass. B264999 Chass. 1920501 - Chass. 1920635	
FL 612	12.95 - 12.99		 1878 000 961	380 10 380GTZ	Chass. B166080 - Chass. B264999 Chass. 1920501 - Chass. 1920635	
FL 614	09.85 - 03.00	KB115A	 3151 600 533	KZA-4	Chass. B166080 - Chass. B264999 Chass. 1920501 - Chass. 1920635	
FL 614	09.85 - 03.00		 3482 602 008	350 350	Chass. B166080 - Chass. B264999	
FL 614	09.85 - 03.00		 1878 600 563	350 10 350	Chass. B166080 - Chass. B264999	
FL 614	12.95 - 03.00	KB115, KV115B	 3400 037 031  3482 021 031  1878 000 961  3151 600 533	380 10 GM380 380GTZ KZA-4	->Chass. 495167 ->Chass. B166079 ->Chass. 1920500	
FL 614	12.95 - 03.00		KB115	 3482 602 002	380 M380	Chass. B166080 - Chass. B264999 Chass. 1920501 - Chass. 1920635
FL 614	12.95 - 03.00			 1878 000 961	380 10 380GTZ	Chass. B166080 - Chass. B264999 Chass. 1920501 - Chass. 1920635
FL 614	12.95 - 03.00	KB115A	 3151 600 533	KZA-4	Chass. B166080 - Chass. B264999 Chass. 1920501 - Chass. 1920635	
FL 614	12.95 - 03.00		 3482 602 003	380 380	Chass. B166080 - Chass. B264999 Chass. 1920501 - Chass. 1920635	
FL 614	12.95 - 03.00		 1878 000 961	380 10 380GTZ	Chass. B166080 - Chass. B264999 Chass. 1920501 - Chass. 1920635	
FL 615	11.91 - 03.00	KB115A	 3151 600 533	KZA-4	Chass. B166080 - Chass. B264999 Chass. 1920501 - Chass. 1920635	
FL 615	11.91 - 03.00		 3482 602 003	380 380	Chass. B166080 - Chass. B264999 Chass. 1920501 - Chass. 1920635	
FL 615	11.91 - 03.00		 1878 000 961	380 10 380GTZ	Chass. B166080 - Chass. B264999 Chass. 1920501 - Chass. 1920635	
FL 615	12.95 - 03.00	KB115A	 3151 600 533	KZA-4	Chass. B166080 - Chass. B264999 Chass. 1920501 - Chass. 1920635	
FL 615	12.95 - 03.00		 3482 602 003	380 380	Chass. B166080 - Chass. B264999 Chass. 1920501 - Chass. 1920635	
FL 615	12.95 - 03.00	KB115A	 1878 000 961	380 10 380GTZ	Chass. B166080 - Chass. B264999 Chass. 1920501 - Chass. 1920635	
FL 615	12.95 - 03.00		3151 600 533	KZA-4	Chass. B166080 - Chass. B264999 Chass. 1920501 - Chass. 1920635	

VOLVO

FL 6		09.85 - 03.00					
FL 616	11.96-05.00	KB114B	 3482 909 001 #	350	Chass. B166080 - Chass. B264999		
FL 617	11.96-05.00			MF350	Chass. 1920501 - Chass. 1920635		
FL 618	11.91-03.00		 1878 600 563	350 10	Chass. B166080 - Chass. B264999		
FL 618	11.91-03.00			350	Chass. 1920501 - Chass. 1920635		
FL 618	11.91-03.00		 3151 600 534	KZA-4	Chass. B166080 - Chass. B264999		
FL 618	11.91-03.00	KB114C	 3400 116 101 #	350 10	->Chass. 495167		
FL 618	12.95-03.00			 3482 909 001	MF350	->Chass. B166079	
FL 618	12.95-03.00			 1862 974 002	350CPB	->Chass. 1920500	
FL 618	12.95-03.00			 3151 600 534	KZA-4		
FL 618	12.95-03.00			 3482 909 001 #	350	Chass. B166080 - Chass. B264999	
FL 619	09.85-11.94			MF350	Chass. 1920501 - Chass. 1920635		
FL 626	11.96-05.00		 3151 600 534	KZA-4	Chass. B166080 - Chass. B264999		
		KB114D	 3482 602 008	350	Chass. B166080 - Chass. B264999		
					350		
				 1878 600 563	350 10	Chass. B166080 - Chass. B264999	
				350			
			 3151 600 534	KZA-4	Chass. B166080 - Chass. B264999		
		KB115	 3482 602 002	380	->Chass. 495167		
					M380	->Chass. B166079	
						->Chass. 1920500	
				 1878 000 961	380 10	->Chass. 495167	
					380GTZ	->Chass. B166079	
						->Chass. 1920500	
				 3151 600 533	KZA-4	->Chass. 495167	
						->Chass. B166079	
					->Chass. 1920500		
					Getr. / GBox: R1100,S6-65		
					Getr. / GBox: T700,ST700		
			 3151 824 005	KZA-4	->Chass. 495167		
					->Chass. B166079		
					->Chass. 1920500		
					Getr. / GBox: R52B		
			 3482 602 002	380	Chass. B166080 - Chass. B264999		
				M380	Chass. 1920501 - Chass. 1920635		
			 1878 000 961	380 10	Chass. B166080 - Chass. B264999		
				380GTZ	Chass. 1920501 - Chass. 1920635		
			 3151 600 533	KZA-4	Chass. B166080 - Chass. B264999		
					Chass. 1920501 - Chass. 1920635		
		KB115A	 3482 602 003	380	->Chass. 495167		
					380	->Chass. B166079	
						->Chass. 1920500	
				 1878 000 961	380 10	->Chass. 495167	
					380GTZ	->Chass. B166079	
						->Chass. 1920500	
			 3151 600 533	KZA-4	->Chass. 495167		
					->Chass. B166079		
					->Chass. 1920500		
			 3482 602 003	380	Chass. B166080 - Chass. B264999		
				380	Chass. 1920501 - Chass. 1920635		
			 1878 000 961	380 10	Chass. B166080 - Chass. B264999		
				380GTZ	Chass. 1920501 - Chass. 1920635		
			 3151 600 533	KZA-4	Chass. B166080 - Chass. B264999		
					Chass. 1920501 - Chass. 1920635		
		KV115B	 3400 037 031	380 10	->Chass. 495167		
				 3482 021 031	GM380	->Chass. B166079	
			 1878 000 961	380GTZ	->Chass. 1920500		
			 3151 600 533	KZA-4	Getr. / GBox: R1100,S6-65		
					Getr. / GBox: T700,ST700		
			 3400 037 032	380 10	->Chass. 495167		
			 3482 021 031	GM380	->Chass. B166079		
			 1878 000 961	380GTZ	->Chass. 1920500		
			 3151 824 005	KZA-4	Getr. / GBox: R52B		















		CODE				
--	--	------	--	---	---	---

VOLVO

FL 7		09.85 - 09.98						
Mot. TD 71, 73	01.85-	KFD117A	 3400 040 032 ⊕ ⊕ 3483 034 032 ⊕ 1861 988 040	430 10 MFZ430 430GVZ	-> Chass. 900816 Getr. / GBox: R/SR1400,1700			
			 3482 123 235	430 MFZ430	-> Chass. 900816 Getr. / GBox: R1000,R/SR,1400,1700 In 3483/3488 enthalten / Contained in 3483, 3488		(30)	
			 1862 349 031	400 10 400GVZ	-> Chass. 900816 Getr. / GBox: R1000,R/SR,1400,1700			
			 3400 035 032 #⊕ ⊕ 3483 034 032 ⊕ 1861 988 034	430 10 MFZ430 430GVZ	Getr. / GBox: R52B			
			 3482 123 235	430 MFZ430	Getr. / GBox: R52B In 3483/3488 enthalten / Contained in 3483, 3488		(30)	
			KFD117A, B	 3482 123 235	430 MFZ430	Getr. / GBox: R/SR62 In 3483/3488 enthalten / Contained in 3483, 3488		(30)
			KFD214A	 3400 031 033 ⊕ ⊕ 3483 014 132 ⊕ 1878 001 080 1878 001 082 3474 012 000	350 10 GMFZ2/350 350GTZ 350GTZ	Getr. / GBox: R/SR,1400 ohne Zwischenring / without intermediate ring		(105)
		 3488 013 138 ⊕		350 GMFZ2/350	Getr. / GBox: R/SR,1400 enthält eine Kupplungsscheibe / This part number includes one clutch disc		(66)	
		 1878 001 082 ▽		350 10 350GTZ	Getr. / GBox: R/SR,1400			
		 3482 056 031		350 GMFZ2/350	Getr. / GBox: R/SR,1400 In 3483/3488 enthalten / Contained in 3483, 3488		(30)	
 3459 000 009	350 GMFZ2/350	Getr. / GBox: R/SR,1400 In 3483/3488 enthalten / Contained in 3483, 3488		(30)				
Mot. TD 71, 73		KFD116A	 3400 700 301 #⊕ ⊕ 3483 022 031 ⊕ 1862 349 031	400 10 MFZ400X 400GVZ	Chass. 358958-> Getr. / GBox: R1000,R/SR,1400,1700			
			 3482 101 032	400 MFZ400X	Chass. 358958-> Getr. / GBox: R1000,R/SR,1400,1700 In 3483/3488 enthalten / Contained in 3483, 3488		(30)	

















		CODE				
--	--	------	--	---	---	---

VOLVO







FL 10		09.85 - 09.98				
Mot. TD 101, 102, 103	01.85-	KFD214A	 3400 031 033 ⊕ ⊕ 3483 014 132 ⊕ 1878 001 080 1878 001 082 3474 012 000	350 10 GMFZ2/350 350GTZ 350GTZ	Getr. / GBox: R/SR1400,1700 ohne Zwischenring / without intermediate ring	(105)
			 3488 013 138 ⊕	350 GMFZ2/350	Getr. / GBox: R/SR1400,1700 enthält eine Kupplungsscheibe / This part number includes one clutch disc	(66)
			 1878 001 082 ▽	350 10 350GTZ	Getr. / GBox: R/SR1400,1700 Lose Kupplungsscheibe / Loose clutch disc	(39)
			 3482 056 031	350 GMFZ2/350	Getr. / GBox: R/SR1400,1700 In 3483/3488 enthalten / Contained in 3483, 3488	(30)
			 3459 000 009	350 GMFZ2/350	Getr. / GBox: R/SR1400,1700 In 3483/3488 enthalten / Contained in 3483, 3488	(30)
			 3400 032 033 #⊕ ⊕ 3483 014 131 ⊕ 1878 001 080 1878 001 082 3474 012 000	350 10 GMFZ2/350 350GTZ 350GTZ	Getr. / GBox: SR62 ohne Zwischenring / without intermediate ring	(105)
			 1878 001 082 ▽	350 10 350GTZ	Getr. / GBox: SR62 Lose Kupplungsscheibe / Loose clutch disc	(39)
			 3482 056 031	350 GMFZ2/350	Getr. / GBox: SR62 In 3483/3488 enthalten / Contained in 3483, 3488	(30)
			 3459 000 009	350 GMFZ2/350	Getr. / GBox: SR62 In 3483/3488 enthalten / Contained in 3483, 3488	(30)
		KFD116B	 3400 700 301 #⊕ ⊕ 3483 022 031 ⊕ 1862 349 031	400 10 MFZ400X 400GVZ	Getr. / GBox: R/SR1400/1700	
			 3482 101 032	400 MFZ400X	Getr. / GBox: R/SR1400/1700 In 3483/3488 enthalten / Contained in 3483, 3488	(30)
		KFD117B	 3482 123 235	430 MFZ430	Getr. / GBox: R/SR62 In 3483/3488 enthalten / Contained in 3483, 3488	(30)
		KFD117B, C	 3400 106 031 ⊕ ⊕ 3483 034 032 ⊕ 1862 530 231	430 10 MFZ430 430WGTZ	Getr. / GBox: R/SR1400,1700	
			 3400 040 032 ●⊕ ⊕ 3483 034 032 ⊕ 1861 988 040	430 10 MFZ430 430GVZ	Getr. / GBox: R/SR1400,1700	
			 3482 123 235	430 MFZ430	Getr. / GBox: R/SR1400,1700 In 3483/3488 enthalten / Contained in 3483, 3488	(30)



		CODE				
--	--	------	--	---	---	---

VOLVO

FL 10		09.85 - 09.98						
FL 10/260	01.85 - 12.89	KFD116B		3400 700 301 #⊕ ⊕ 3483 022 031 ⊕ 1862 349 031	400 10 MFZ400X 400GVZ	Getr. / GBox: R/SR1400/1700		
FL 10/280	09.85 - 12.90				3482 101 032	400 MFZ400X	Getr. / GBox: R/SR1400/1700 In 3483/3488 enthalten / Contained in 3483, 3488	(30)
FL 10/280	09.85 - 12.90							
FL 10/280	09.85 - 12.90	KFD117B		3482 123 235	430 MFZ430	Getr. / GBox: R/SR62 In 3483/3488 enthalten / Contained in 3483, 3488	(30)	
FL 10/285	01.90 - 12.95							
FL 10/290	01.88 - 12.89							
FL 10/320	01.90 - 12.95	KFD117C, H		3400 040 032 ⊕ ⊕ 3483 034 032 ⊕ 1861 988 040	430 10 MFZ430 430GVZ	Getr. / GBox: R/SR1400/1700		
FL 10/320	12.95 - 09.98							
FL 10/320	12.95 - 09.98				3482 123 235	430 MFZ430	Getr. / GBox: R/SR1400/1700 In 3483/3488 enthalten / Contained in 3483, 3488	(30)
FL 10/320	12.95 - 09.98	KFD117C, H		3400 040 032 ⊕ ⊕ 3483 034 032 ⊕ 1861 988 040	430 10 MFZ430 430GVZ	Getr. / GBox: R/SR1400/1700		
FL 10/320	12.95 - 09.98							
FL 10/320	12.95 - 09.98				3400 106 031 ●⊕ ⊕ 3483 034 032 ⊕ 1862 530 231	430 10 MFZ430 430WGTZ	Getr. / GBox: R/SR1400/1700	
FL 10/360	12.95 - 09.98	KFD214A		3482 123 235	430 MFZ430	Getr. / GBox: R/SR1400/1700 In 3483/3488 enthalten / Contained in 3483, 3488	(30)	
FL 10/360	12.95 - 09.98							
FL 10/360	12.95 - 09.98				3400 032 033 #⊕ ⊕ 3483 014 131 ⊕ 1878 001 080 1878 001 082 3474 012 000	350 10 GMFZ2/350 350GTZ 350GTZ	Getr. / GBox: R/SR62 ohne Zwischenring / without intermediate ring	(105)
FL 10/360	12.95 - 09.98			1878 001 082 ▽	350 10 350GTZ	Getr. / GBox: R/SR62 Lose Kupplungsscheibe / Loose clutch disc	(39)	
FL 10/360	12.95 - 09.98			3482 056 031	350 GMFZ2/350	Getr. / GBox: R/SR62 In 3483/3488 enthalten / Contained in 3483, 3488	(30)	
FL 10H/320	12.95 - 09.98			3459 000 009	350 GMFZ2/350	Getr. / GBox: R/SR62 In 3488 enthalten / Contained in 3488	(31)	
FL 10H/320	12.95 - 09.98			3400 031 033 ⊕ ⊕ 3483 014 132 ⊕ 1878 001 080 1878 001 082 3474 012 000	350 10 GMFZ2/350 350GTZ 350GTZ	Getr. / GBox: R/SR1400/1700 ohne Zwischenring / without intermediate ring	(105)	
FL 10H/360	12.95 - 09.98			3488 013 138 ⊕	350 GMFZ2/350	Getr. / GBox: R/SR1400/1700 enthält eine Kupplungsscheibe / This part number includes one clutch disc	(66)	
FL 10H/360	12.95 - 09.98			1878 001 082 ▽	350 10 350GTZ	Getr. / GBox: R/SR1400/1700 Lose Kupplungsscheibe / Loose clutch disc	(39)	
FL 10H/360	12.95 - 09.98			3482 056 031	350 GMFZ2/350	Getr. / GBox: R/SR1400/1700 In 3483/3488 enthalten / Contained in 3483, 3488	(30)	
FL 10H/360	12.95 - 09.98			3459 000 009	350 GMFZ2/350	Getr. / GBox: R/SR1400/1700 In 3483/3488 enthalten / Contained in 3483, 3488	(30)	



VOLVO











































FL 12		09.95 - 09.98					
Mot. D 12 A	01.95 -	CL43S-O		3400 043 032 ⊕ ⊗ 3483 034 033 ⊙ 1878 634 026	430 10 MFZ430 430WGTZ	Getr. / GBox: R/SR1700,1900	
FL 12/380	09.95 - 09.98						
FL 12/380	09.95 - 09.98			3482 123 234	430 MFZ430	Getr. / GBox: R/SR1700,1900 In 3483/3488 enthalten / Contained in 3483, 3488	(30)
FL 12/380	09.95 - 09.98						
FL 12/380	09.95 - 09.98	CL38D-O		3400 700 426 ⊕ ⊗ 3488 019 031 ⊙ 1862 415 031	380 10 GMFZ2/380 380WGVZ	Getr. / GBox: R/SR1700,1900	
FL 12/380	09.95 - 09.98						
FL 12/380	09.95 - 09.98			3400 700 325 ⊕ ⊗ 3483 027 231 ⊙ 1862 248 033 1862 415 031	380 10 GMFZ2/380 380GVZ 380WGVZ	Getr. / GBox: R/SR1700,1900 ohne Zwischenring / without intermediate ring	(105)
FL 12/420	09.95 - 09.98						
FL 12/420	09.95 - 09.98			3482 111 031	380 GMFZ2/380	Getr. / GBox: R/SR1700,1900 In 3483/3488 enthalten / Contained in 3483, 3488	(30)
FL 12/420	09.95 - 09.98						
FL 12/420	09.95 - 09.98			3459 017 031	380 GMFZ2/380	Getr. / GBox: R/SR1700,1900 In 3488 enthalten / Contained in 3488	(31)
FL 12H/380	09.95 - 09.98						
FL 12H/380	09.95 - 09.98						
FL 12H/380	09.95 - 09.98						
FL 12H/380	09.95 - 09.98						
FL 12H/420	09.95 - 09.98						
FL 12H/420	09.95 - 09.98						
FL 12H/420	09.95 - 09.98						
FL 12H/420	09.95 - 09.98						

FL II		05.06 -					
FL 240-12	05.06 -			3400 700 466 ⊗ 3482 634 003 ⊙ 1878 634 034 ⊙ 3151 000 752	395 10 MF395 395WGTZ KZIS-4	Getr. / GBox: ZTO1006, ZTO1109	
FL 240-12	05.06 -						
FL 240-14	06.09 -			3151 000 752	KZIS-4	Getr. / GBox: ATO1056	
FL 240-14	06.09 -						
FL 240-15	05.06 -			1863 869 039	52		
FL 240-16	05.06 -						
FL 240-16	05.06 -						
FL 240-16	06.09 -						
FL 240-18	05.06 -						
FL 260-12	06.09 -						
FL 260-12	06.09 -						
FL 260-14	06.09 -						
FL 260-14	06.09 -						
FL 260-15	06.09 -						
FL 260-16	06.09 -						
FL 260-16	06.09 -						
FL 260-18	06.09 -						
FL 260-16	06.09 -						
FL 280-12	05.06 -						
FL 280-12	05.06 -						
FL 280-14	06.09 -						
FL 280-14	06.09 -						
FL 280-15	05.06 -						
FL 280-16	05.06 -						
FL 280-16	05.06 -						
FL 280-18	05.06 -						
FL 290-12	06.09 -						
FL 290-12	06.09 -						
FL 290-14	06.09 -						
FL 290-16	06.09 -						
FL 290-16	06.09 -						
FL 290-16	06.09 -						
FL 290-18	06.09 -						

		CODE				
--	--	------	--	---	---	---























VOLVO

FLC		09.96 - 09.00				
FLC 140	09.96 - 09.00	KB112	 3482 008 244	310		
FLC 140	09.96 - 09.00		 1878 021 731	MF310		
			 3182 998 501	310 10 310WGTZ	HHIS-3	ohne Sensor / without sensor Füllmedium: Bremsflüssigkeit / Fill Medium: Brake Fluid Immer erneuern / Renew everytime

FM		09.05 -				
FM 300	09.05 -		 3400 710 060	430 24	Mot. D9B300	
FM 300	09.05 -		 3482 000 552	MF430	Getr. / GBox: AT2412C, AT2512C	
FM 300	09.05 -		 1878 003 867	430WGTZ		
FM 300	09.05 -		 6482 000 155	PHIS-6/38		
FM 300	09.05 -		 1863 869 037	72	Mot. D9B300	
FM 300	09.05 -		 3400 700 471 ⊕	430 24	Getr. / GBox: AT2412C, AT2512C	
FM 300	09.05 -		 3483 034 034	MFZ430	Mot. D9B300	
FM 300	09.05 -		 1878 001 215	430WGTZ	Getr. / GBox: VT2214B, VTO2214B	
FM 300	09.05 -		 1863 869 037	72	Mot. D9B300	
FM 300	09.05 -		 3400 700 472 ⊕	430 24	Getr. / GBox: VT2214B, VTO2214B	
FM 300	09.05 -		 3483 034 033	MFZ430	Mot. D9B300	
FM 300	09.05 -		 1878 005 284	430WGTZ	Getr. / GBox: VT2009B	
FM 300	09.05 -		 1863 869 037	72	Mot. D9B300	
FM 300	09.05 -		 3400 710 060	430 24	Getr. / GBox: VT2009B	
FM 300	09.05 -		 3482 000 552	MF430	Mot. D9A300, D9B300	
FM 300	09.05 -	 1878 003 867	430WGTZ	Getr. / GBox: AT2412C, AT2512C		
FM 300	09.05 -	 6482 000 155	PHIS-6/38			
FM 300	09.05 -	 1863 869 037	72	Mot. D9A300, D9B300		
FM 300	09.05 -	 3400 700 471 ⊕	430 24	Getr. / GBox: AT2412C, AT2512C		
FM 300	09.05 -	 3483 034 034	MFZ430	Mot. D9A300, D9B300		
FM 300	09.05 -	 1878 001 215	430WGTZ	Getr. / GBox: VT2214B, VTO2214B		
FM 300	09.05 -	 1863 869 037	72	Mot. D9A300, D9B300		
FM 300	09.05 -	 3400 700 472 ⊕	430 24	Getr. / GBox: VT2214B, VTO2214B		
FM 300	09.05 -	 3483 034 033	MFZ430	Mot. D9A300, D9B300		
FM 300	09.05 -	 1878 005 284	430WGTZ	Getr. / GBox: VT2009B		
FM 300	09.05 -	 1863 869 037	72	Mot. D9A300, D9B300		
FM 300	09.05 -	 3400 700 348 ⊕	380 24	Getr. / GBox: VT2009B		
FM 300	09.05 -	 3488 019 032	GMFZ2/380	Mot. D11C330		
FM 300	09.05 -	 1878 001 216	380WGVZ	Getr. / GBox: AT2412D, AT2612D		
FM 300	09.05 -	 3400 700 360 ⊕	400 24	Mot. D11C330		
FM 300	09.05 -	 3488 000 159	MFZ2/400X	Getr. / GBox: VT2214B, VT2514B		
FM 300	09.05 -	 1878 003 768	400WGTZ	Getr. / GBox: VTO2214B, VTO2514B		
FM 300	09.05 -	 3400 700 358 ⊖	430 24	Mot. D11C330		
FM 300	09.05 -	 3482 000 552	MF430	Getr. / GBox: AT2412D, AT2612D		
FM 300	09.05 -	 1878 003 867	430WGTZ	Getr. / GBox: ATO2612D		
FM 300	09.05 -	 6482 000 155	PHIS-6/38	Mot. D11C330		
FM 300	09.05 -	 3400 700 478 ⊕	430 24	Getr. / GBox: AT2412D, AT2612D		
FM 300	09.05 -	 3483 000 382	MFZ430	Mot. D11C330		
FM 300	09.05 -	 1878 006 129	430WGTZ	Getr. / GBox: VT2009B		
FM 300	09.05 -	 3400 700 463 ⊕	430 24	Mot. D11C330		
FM 300	09.05 -	 3483 000 348	MFZ430	Getr. / GBox: VT2214B, VT2514B		
FM 300	09.05 -	 1878 006 129	430WGTZ	Getr. / GBox: VTO2214B, VTO2514B		























		CODE				
--	--	------	--	---	---	---

VOLVO

FM		09.05 -				
FM 360 FM 360	11.05- 11.05-	CS43B-O	 1878 006 129	430 24 430WGTZ	Mot. D13A360, D13B360 Getr. / GBox: VT2009B	
			 3100 026 434 ◦ 3151 000 163 ◎ 3180 000 009	KZIZ-5 KZISZ-5	Mot. D13A360, D13B360 Getr. / GBox: VT2009B Beinhaltet Ausrücker und Montagesatz / Contains releaser and fitting kit In 3483/3488 enthalten / Contained in 3483, 3488	(14) (30)
	CS43B-OR	 1878 006 129	430 24 430WGTZ	Mot. D13A360, D13B360 Getr. / GBox: VT2009B		
		 3100 026 434 ◦ 3151 000 163 ◎ 3180 000 009	KZIZ-5 KZISZ-5	Mot. D13A360, D13B360 Getr. / GBox: VT2009B Beinhaltet Ausrücker und Montagesatz / Contains releaser and fitting kit In 3483/3488 enthalten / Contained in 3483, 3488	(14) (30)	
	CS43B-O/OR	 3400 700 463 ⊕ ◎ 3483 000 348 ◎ 1878 006 129	430 24 MFZ430 430WGTZ	Mot. D13A360, D13B360 Getr. / GBox: VT2214B, VT2514B Getr. / GBox: VTO2214B, VTO2514B		
			 3400 710 061 ◎ 3482 000 553 ◎ 1878 006 129 ☞ 6482 000 155	430 24 MF430 430WGTZ PHIS-6/38	Mot. D13A360, D13B360 Getr. / GBox: AT2412C, AT2512C Getr. / GBox: ATO2512C	
			 3400 700 478 ⊕ ◎ 3483 000 382 ◎ 1878 006 129	430 24 MFZ430 430WGTZ	Mot. D13A360, D13B360 Getr. / GBox: VT2009B	
	CD38B-O	 3400 700 348 ⊕ ◎ 3488 019 032 ◎ 1878 001 216	380 24 GMFZ2/380 380WGVZ	Mot. D13A360, D13B360		
			 3483 027 332 ⊕	380 GMFZ2/380	Mot. D13A360, D13B360 In 3483/3488 enthalten / Contained in 3483, 3488	(30)
			 3482 111 031	380 GMFZ2/380	Mot. D13A360, D13B360 In 3483/3488 enthalten / Contained in 3483, 3488	(30)
			 3459 017 031	380 GMFZ2/380	Mot. D13A360, D13B360 In 3488 enthalten / Contained in 3488	(31)
			 1862 248 033 △	380 8 380GVZ	Mot. D13A360, D13B360 In 3488 enthalten / Contained in 3488	(31)
	CD40B-O	 3400 700 360 ⊕ ◎ 3488 000 159 ◎ 1878 003 768	400 24 MFZ2/400X 400WGTZ	Mot. D13A360, D13B360		
			 3483 034 135 ⊕	400 MFZ2/400X	Mot. D13A360, D13B360 In 3488 enthalten / Contained in 3488	(31)
			 3459 018 004	400 MFZ2/400X	Mot. D13A360, D13B360 In 3488 enthalten / Contained in 3488	(31)
		 1863 869 037	72			
FM 370 FM 370 FM 370 FM 370 FM 370 FM 370 FM 370 FM 370 FM 370 FM 370 FM 370 FM 370 FM 370 FM 370 FM 370	09.05- 09.05-	CD38B-O	 3400 700 348 ⊕ ◎ 3488 019 032 ◎ 1878 001 216	380 24 GMFZ2/380 380WGVZ	Mot. D11C370	
			CD40B-O	 3400 700 360 ⊕ ◎ 3488 000 159 ◎ 1878 003 768	400 24 MFZ2/400X 400WGTZ	Mot. D11C370 Getr. / GBox: VT2214B, VT2514B Getr. / GBox: VTO2214B, VTO2514B
	CS43B-O	 3400 700 358 ⊖ ◎ 3482 000 552 ◎ 1878 003 867		430 24 MF430 430WGTZ	Mot. D11C370 Getr. / GBox: AT2412D, AT2612D Getr. / GBox: ATO2612D	
		 6482 000 155	PHIS-6/38	Mot. D11C370 Getr. / GBox: AT2412D, AT2612D Getr. / GBox: ATO2612D		
	CS43B-OR	 3400 700 478 ⊕ ◎ 3483 000 382 ◎ 1878 006 129	430 24 MFZ430 430WGTZ	Mot. D11C370 Getr. / GBox: VT2009B		
		 3400 700 463 ⊕ ◎ 3483 000 348 ◎ 1878 006 129	430 24 MFZ430 430WGTZ	Mot. D11C370 Getr. / GBox: VT2214B, VT2514B Getr. / GBox: VTO2214B, VTO2514B		

























		CODE				
--	--	------	--	---	---	---

VOLVO

FM		09.05 -			
FM 400	09.05-	CS43B-O	 1878 006 129 430 24 430WGTZ	Mot. D13A400, D13B400 Getr. / GBox: VT2009B	
FM 400	09.05-		 3100 026 434 ◊ 3151 000 163 ◎ 3180 000 009	KZIZ-5 KZISZ-5	Mot. D13A400, D13B400 Getr. / GBox: VT2009B
FM 400	09.05-				Beinhaltet Ausrücker und Montagesatz / Contains releaser and fitting kit (14)
FM 400	09.05-				In 3483/3488 enthalten / Contained in 3483, 3488 (30)
FM 400	09.05-	CS43B-OR	 1878 006 129 430 24 430WGTZ	Mot. D13A400, D13B400 Getr. / GBox: VT2009B	
FM 400	09.05-		 3100 026 434 ◊ 3151 000 163 ◎ 3180 000 009	KZIZ-5 KZISZ-5	Mot. D13A400, D13B400 Getr. / GBox: VT2009B
FM 400	09.05-				Beinhaltet Ausrücker und Montagesatz / Contains releaser and fitting kit (14)
FM 400	09.05-				In 3483/3488 enthalten / Contained in 3483, 3488 (30)
		CS43B-O/OR	 3400 700 463 ⊕ ◎ 3483 000 348 ◎ 1878 006 129	430 24 MFZ430 430WGTZ	Mot. D13A400, D13B400 Getr. / GBox: VT2214B, VT2514B Getr. / GBox: VTO2214B, VTO2514B
			 3400 710 061 ◎ 3482 000 553 ◎ 1878 006 129 ☞ 6482 000 155	430 24 MF430 430WGTZ PHIS-6/38	Mot. D13A400, D13B400 Getr. / GBox: AT2412C, AT2512C Getr. / GBox: ATO2512C
			 3400 700 478 ⊕ ◎ 3483 000 382 ◎ 1878 006 129	430 24 MFZ430 430WGTZ	Mot. D13A400, D13B400 Getr. / GBox: VT2009B
		CD38B-O	 3400 700 348 ⊕ ◎ 3488 019 032 ◎ 1878 001 216	380 24 GMFZ2/380 380WGVZ	Mot. D13A400, D13B400
			 3483 027 332 ⊕	380 GMFZ2/380	Mot. D13A400, D13B400 In 3483/3488 enthalten / Contained in 3483, 3488 (30)
			 3482 111 031	380 GMFZ2/380	Mot. D13A400, D13B400 In 3483/3488 enthalten / Contained in 3483, 3488 (30)
			 3459 017 031	380 GMFZ2/380	Mot. D13A400, D13B400 In 3488 enthalten / Contained in 3488 (31)
			 1862 248 033 △	380 8 380GVZ	Mot. D13A400, D13B400 In 3488 enthalten / Contained in 3488 (31)
		CD40B-O	 3400 700 360 ⊕ ◎ 3488 000 159 ◎ 1878 003 768	400 24 MFZ2/400X 400WGTZ	Mot. D13A400, D13B400
			 3483 034 135 ⊕	400 MFZ2/400X	Mot. D13A400, D13B400 In 3488 enthalten / Contained in 3488 (31)
			 3459 018 004	400 MFZ2/400X	Mot. D13A400, D13B400 In 3488 enthalten / Contained in 3488 (31)
			 1863 869 037	72	
FM 410	09.05-	CD38B-O	 3400 700 348 ⊕ ◎ 3488 019 032 ◎ 1878 001 216	380 24 GMFZ2/380 380WGVZ	Mot. D11C410
FM 410	09.05-	CD40B-O	 3400 700 360 ⊕ ◎ 3488 000 159 ◎ 1878 003 768	400 24 MFZ2/400X 400WGTZ	Mot. D11C410 Getr. / GBox: VT2214B, VT2514B Getr. / GBox: VTO2214B, VTO2514B
FM 410	09.05-	CS43B-O	 3400 700 358 ⊖ ◎ 3482 000 552 ◎ 1878 003 867	430 24 MF430 430WGTZ	Mot. D11C410 Getr. / GBox: AT2412D, AT2612D Getr. / GBox: ATO2612D
FM 410	09.05-		 6482 000 155	PHIS-6/38	Mot. D11C410 Getr. / GBox: AT2412D, AT2612D Getr. / GBox: ATO2612D
FM 410	09.05-	CS43B-OR	 3400 700 478 ⊕ ◎ 3483 000 382 ◎ 1878 006 129	430 24 MFZ430 430WGTZ	Mot. D11C410 Getr. / GBox: VT2009B
FM 410	09.05-		 3400 700 463 ⊕ ◎ 3483 000 348 ◎ 1878 006 129	430 24 MFZ430 430WGTZ	Mot. D11C410 Getr. / GBox: VT2214B, VT2514B Getr. / GBox: VTO2214B, VTO2514B



















		CODE				
--	--	------	--	---	---	---

VOLVO























FM		09.05 -					
FM 420	09.05-	CD38B-O	 3400 700 348 ⊕ ⊗ 3488 019 032 ⊗ 1878 001 216	380 24 GMFZ2/380 380WGVZ	Mot. D13C420		
FM 420	09.05-		 1863 869 037	72	Mot. D13C420		
FM 420	09.05-	CD40B-O	 3400 700 360 ⊕ ⊗ 3488 000 159 ⊗ 1878 003 768	400 24 MFZ2/400X 400WGTZ	Mot. D13C420 Getr. / GBox: VT2214B, VT2514B Getr. / GBox: VTO2214B, VTO2514B		
FM 420	09.05-		 1863 869 037	72	Mot. D13C420 Getr. / GBox: VT2214B, VT2514B Getr. / GBox: VTO2214B, VTO2514B		
FM 420	09.05-	CS43B-O	 3400 700 359 ⊖ ⊗ 3482 000 553 ⊗ 1878 006 129	430 24 MF430 430WGTZ	Mot. D13C420 Getr. / GBox: AT2412D, AT2612D Getr. / GBox: ATO2612D		
FM 420	09.05-		 6482 000 155	PHIS-6/38	Mot. D13C420 Getr. / GBox: AT2412D, AT2612D Getr. / GBox: ATO2612D		
FM 420	09.05-		 1863 869 037	72	Mot. D13C420 Getr. / GBox: AT2412D, AT2612D Getr. / GBox: ATO2612D		
FM 420	09.05-	CS43B-OR	 3400 700 478 ⊕ ⊗ 3483 000 382 ⊗ 1878 006 129	430 24 MFZ430 430WGTZ	Mot. D13C420 Getr. / GBox: VT2009B		
FM 420	09.05-		 1863 869 037	72	Mot. D13C420 Getr. / GBox: VT2009B		
FM 420	09.05-		 3400 700 463 ⊕ ⊗ 3483 000 348 ⊗ 1878 006 129	430 24 MFZ430 430WGTZ	Mot. D13C420 Getr. / GBox: VT2214B, VT2514B Getr. / GBox: VTO2214B, VTO2514B		
FM 420	09.05-		 1863 869 037	72	Mot. D13C420 Getr. / GBox: VTO2214B, VTO2514B Getr. / GBox: VT2214B, VT2514B		
FM 420			 3400 700 600 ⊕ ⊗ 3483 000 348 ⊗ 1878 007 046	430 24 MFZ430	Mot. D13K Getr. / GBox: VT 2214B / VTO 2214B Getr. / GBox: VT 2514B / VTO 2514B Abgasnorm: Euro 6 / Exhaust Emission Norm: Euro 6	(4)	
FM 420			 3400 710 064 ⊗ 3482 001 169 ⊗ 1878 007 170 ⊗ 6482 000 155	430 24 MFZ430 430WGTZ PHIS-6/38	Mot. D13K Getr. / GBox: AT2412/E / AT2612/E Getr. / GBox: ATO 2612/E Abgasnorm: Euro 6 / Exhaust Emission Norm: Euro 6	(4)	
FM 440	09.05-	CS43B-O/OR	 3400 700 463 ⊕ ⊗ 3483 000 348 ⊗ 1878 006 129	430 24 MFZ430 430WGTZ	Mot. D13A440, D13B440 Getr. / GBox: VT2214B, VT2514B Getr. / GBox: VTO2214B, VTO2514B		
FM 440	09.05-		 3400 710 061 ⊗ 3482 000 553 ⊗ 1878 006 129 ⊗ 6482 000 155	430 24 MF430 430WGTZ PHIS-6/38	Mot. D13A440, D13B440 Getr. / GBox: AT2412C, AT2512C Getr. / GBox: ATO2512C		
FM 440	09.05-	CD38B-O	 3400 700 348 ⊕ ⊗ 3488 019 032 ⊗ 1878 001 216	380 24 GMFZ2/380 380WGVZ	Mot. D13A440, D13B440		
FM 440	09.05-		 3483 027 332 ⊕	380 GMFZ2/380	Mot. D13A440, D13B440 In 3483/3488 enthalten / Contained in 3483, 3488	(30)	
FM 440	09.05-		 3482 111 031	380 GMFZ2/380	Mot. D13A440, D13B440 In 3483/3488 enthalten / Contained in 3483, 3488	(30)	
FM 440	09.05-		 1862 248 033 △	380 8 380GVZ	Mot. D13A440, D13B440 In 3488 enthalten / Contained in 3488	(31)	
FM 440	09.05-		 3459 017 031	380 GMFZ2/380	Mot. D13A440, D13B440 In 3488 enthalten / Contained in 3488	(31)	
FM 440	09.05-	CD40B-O	 3400 700 360 ⊕ ⊗ 3488 000 159 ⊗ 1878 003 768	400 24 MFZ2/400X 400WGTZ	Mot. D13A440, D13B440		
FM 440	09.05-		 3483 034 135 ⊕	400 MFZ2/400X	Mot. D13A440, D13B440 In 3488 enthalten / Contained in 3488	(31)	
FM 440	09.05-		 3459 018 004	400 MFZ2/400X	Mot. D13A440, D13B440 In 3488 enthalten / Contained in 3488	(31)	
FM 440	09.05-		 1863 869 037	72			

		CODE				
--	--	------	--	---	---	---

VOLVO

























FM		09.05 -				
FM 450	09.05-	CD38B-O	 3400 700 348 ⊕ ⊗ 3488 019 032 ⊗ 1878 001 216	380 24 GMFZ2/380 380WGVZ	Mot. D11C450	
FM 450	09.05-	CD40B-O	 3400 700 360 ⊕ ⊗ 3488 000 159 ⊗ 1878 003 768	400 24 MFZ2/400X 400WGTZ	Mot. D11C450	
FM 450	09.05-				Getr. / GBox: VT2214B, VT2514B Getr. / GBox: VTO2214B, VTO2514B	
FM 450	09.05-	CS43B-O	 3400 700 359 ⊖ ⊗ 3482 000 553 ⊗ 1878 006 129	430 24 MF430 430WGTZ	Mot. D11C450	
FM 450	09.05-				Getr. / GBox: AT2412D, AT2612D Getr. / GBox: ATO2612D	
FM 450	09.05-	CS43B-OR	 6482 000 155	PHIS-6/38	Mot. D11C450	
FM 450	09.05-				Getr. / GBox: AT2412D, AT2612D Getr. / GBox: ATO2612D	
FM 450	09.05-	CS43B-OR	 3400 700 478 ⊕ ⊗ 3483 000 382 ⊗ 1878 006 129	430 24 MFZ430 430WGTZ	Mot. D11C450	
FM 450	09.05-				Getr. / GBox: VT2009B	
FM 450	09.05-		 3400 700 463 ⊕ ⊗ 3483 000 348 ⊗ 1878 006 129	430 24 MFZ430 430WGTZ	Mot. D11C450	
FM 450	09.05-				Getr. / GBox: VT2214B, VT2514B Getr. / GBox: VTO2214B, VTO2514B	
FM 450	09.05-					
FM 450	09.05-					
FM 450	09.05-					
FM 460	09.05-	CD38B-O	 3400 700 348 ⊕ ⊗ 3488 019 032 ⊗ 1878 001 216	380 24 GMFZ2/380 380WGVZ	Mot. D13C460	
FM 460	09.05-				 1863 869 037	72
FM 460	09.05-	CD40B-O	 3400 700 360 ⊕ ⊗ 3488 000 159 ⊗ 1878 003 768	400 24 MFZ2/400X 400WGTZ	Mot. D13C460	
FM 460	09.05-				Getr. / GBox: VT2214B, VT2514B Getr. / GBox: VTO2214B, VTO2514B	
FM 460	09.05-		 1863 869 037	72	Mot. D13C460	
FM 460	09.05-				Getr. / GBox: VT2214B, VT2514B Getr. / GBox: VTO2214B, VTO2514B	
FM 460	09.05-	CS43B-O	 3400 700 359 ⊖ ⊗ 3482 000 553 ⊗ 1878 006 129	430 24 MF430 430WGTZ	Mot. D13C460	
FM 460	09.05-				Getr. / GBox: AT2412D, AT2612D Getr. / GBox: ATO2612D	
FM 460	09.05-		 6482 000 155	PHIS-6/38	Mot. D13C460	
FM 460	09.05-				Getr. / GBox: AT2412D, AT2612D Getr. / GBox: ATO2612D	
FM 460	09.05-		 1863 869 037	72	Mot. D13C460	
FM 460	09.05-				Getr. / GBox: AT2412D, AT2612D Getr. / GBox: ATO2612D	
FM 460	09.05-	CS43B-OR	 3400 700 478 ⊕ ⊗ 3483 000 382 ⊗ 1878 006 129	430 24 MFZ430 430WGTZ	Mot. D13C460	
FM 460	09.05-				Getr. / GBox: VT2009B	
FM 460	09.05-		 1863 869 037	72	Mot. D13C460	
FM 460	09.05-				Getr. / GBox: VT2009B	
FM 460	09.05-		 3400 700 463 ⊕ ⊗ 3483 000 348 ⊗ 1878 006 129	430 24 MFZ430 430WGTZ	Mot. D13C460	
FM 460	09.05-				Getr. / GBox: VT2214B, VT2514B Getr. / GBox: VTO2214B, VTO2514B	
FM 460	09.05-		 1863 869 037	72	Mot. D13C460	
FM 460	09.05-				Getr. / GBox: VT2214B, VT2514B Getr. / GBox: VTO2214B, VTO2514B	
FM 460			 3400 700 600 ⊕ ⊗ 3483 000 348 ⊗ 1878 007 046	430 24 MFZ430	Mot. D13K	
					Getr. / GBox: VT 2814B / VTO 2814B Abgasnorm: Euro 6 / Exhaust Emission Norm: Euro 6 (4)	
			 3400 710 064 ⊗ 3482 001 169 ⊗ 1878 007 170 ⊗ 6482 000 155	430 24 MFZ430 430WGTZ PHIS-6/38	Mot. D13K	
					Getr. / GBox: AT 2412/E / AT 2612/E Getr. / GBox: ATO 2612/E Abgasnorm: Euro 6 / Exhaust Emission Norm: Euro 6 (4)	

VOLVO

FM		09.05 -					
FM 480	09.05-	CS43B-O/OR	 3400 700 463 ⊕ ⊗ 3483 000 348 ⊗ 1878 006 129	430 24 MFZ430 430WGTZ	Mot. D13A480 Getr. / GBox: VT2214B, VT2514B Getr. / GBox: VTO2214B, VTO2514B		
FM 480	09.05-		 3400 710 061 ⊗ 3482 000 553 ⊗ 1878 006 129 ⚡ 6482 000 155	430 24 MF430 430WGTZ PHIS-6/38	Mot. D13A480 Getr. / GBox: AT2412C, AT2512C Getr. / GBox: ATO2512C		
FM 480	09.05-		CD38B-O	 3400 700 348 ⊕ ⊗ 3488 019 032 ⊗ 1878 001 216	380 24 GMFZ2/380 380WGVZ	Mot. D13A480	
FM 480	09.05-			 3483 027 332 ⊕	380 GMFZ2/380	Mot. D13A480 In 3483/3488 enthalten / Contained in 3483, 3488	(30)
FM 480	09.05-			 3482 111 031	380 GMFZ2/380	Mot. D13A480 In 3483/3488 enthalten / Contained in 3483, 3488	(30)
FM 480	09.05-			 1862 248 033 △	380 8 380GVZ	Mot. D13A480 In 3488 enthalten / Contained in 3488	(31)
FM 480	09.05-	 3459 017 031		380 GMFZ2/380	Mot. D13A480 In 3488 enthalten / Contained in 3488	(31)	
		CD40B-O	 3400 700 360 ⊕ ⊗ 3488 000 159 ⊗ 1878 003 768	400 24 MFZ2/400X 400WGTZ	Mot. D13A480		
			 3483 034 135 ⊕	400 MFZ2/400X	Mot. D13A480 In 3488 enthalten / Contained in 3488	(31)	
			 3459 018 004	400 MFZ2/400X	Mot. D13A480 In 3488 enthalten / Contained in 3488	(31)	
			 1863 869 037	72			
FM 500	09.05-	CD38B-O	 3400 700 348 ⊕ ⊗ 3488 019 032 ⊗ 1878 001 216	380 24 GMFZ2/380 380WGVZ	Mot. D13C500		
FM 500	09.05-		 1863 869 037	72	Mot. D13C500		
FM 500	09.05-	CD40B-O	 3400 700 360 ⊕ ⊗ 3488 000 159 ⊗ 1878 003 768	400 24 MFZ2/400X 400WGTZ	Mot. D13C500 Getr. / GBox: VT2214B, VT2514B Getr. / GBox: VTO2214B, VTO2514B		
FM 500	09.05-		 1863 869 037	72	Mot. D13C500 Getr. / GBox: VT2214B, VT2514B Getr. / GBox: VTO2214B, VTO2514B		
FM 500	09.05-	CS43B-O	 3400 700 359 ⊖ ⊗ 3482 000 553 ⊗ 1878 006 129	430 24 MF430 430WGTZ	Mot. D13C500 Getr. / GBox: AT2412D, AT2612D Getr. / GBox: ATO2612D		
FM 500	09.05-		 6482 000 155	PHIS-6/38	Mot. D13C500 Getr. / GBox: AT2412D, AT2612D Getr. / GBox: ATO2612D		
FM 500	09.05-		 1863 869 037	72	Mot. D13C500 Getr. / GBox: AT2412D, AT2612D Getr. / GBox: ATO2612D		
FM 500	09.05-	CS43B-OR	 3400 700 478 ⊕ ⊗ 3483 000 382 ⊗ 1878 006 129	430 24 MFZ430 430WGTZ	Mot. D13C500 Getr. / GBox: VT2009B		
FM 500	09.05-		 1863 869 037	72	Mot. D13C500 Getr. / GBox: VT2009B		
FM 500	09.05-		 3400 700 463 ⊕ ⊗ 3483 000 348 ⊗ 1878 006 129	430 24 MFZ430 430WGTZ	Mot. D13C500 Getr. / GBox: VT2214B, VT2514B Getr. / GBox: VTO2214B, VTO2514B		
FM 500	09.05-		 1863 869 037	72	Mot. D13C500 Getr. / GBox: VT2214B, VT2514B Getr. / GBox: VTO2214B, VTO2514B		



		CODE				
--	--	------	--	---	---	---



VOLVO

FM		09.05 -					
FM 500	09.05 -	CD38B-O	 3400 700 348 ⊕ ⊗ 3488 019 032 ⊗ 1878 001 216	380 24 GMFZ2/380 380WGVZ	Mot. D13B500,D13C500		
			 1863 869 037	72	Mot. D13B500,D13C500		
		CD40B-O	 3400 700 360 ⊕ ⊗ 3488 000 159 ⊗ 1878 003 768	400 24 MFZ2/400X 400WGTZ	Mot. D13B500,D13C500 Getr. / GBox: VT2214B, VT2514B Getr. / GBox: VTO2214B, VTO2514B		
			 1863 869 037	72	Mot. D13B500,D13C500 Getr. / GBox: VT2214B, VT2514B Getr. / GBox: VTO2214B, VTO2514B		
		CS43B-O	 3400 700 359 ⊖ ⊗ 3482 000 553 ⊗ 1878 006 129	430 24 MF430 430WGTZ	Mot. D13B500,D13C500 Getr. / GBox: AT2412D, AT2612D Getr. / GBox: ATO2612D		
			 6482 000 155	PHIS-6/38	Mot. D13B500,D13C500 Getr. / GBox: AT2412D, AT2612D Getr. / GBox: ATO2612D		
			 1863 869 037	72	Mot. D13B500,D13C500 Getr. / GBox: AT2412D, AT2612D Getr. / GBox: ATO2612D		
		CS43B-OR	 3400 700 478 ⊕ ⊗ 3483 000 382 ⊗ 1878 006 129	430 24 MFZ430 430WGTZ	Mot. D13B500,D13C500 Getr. / GBox: VT2009B		
			 1863 869 037	72	Mot. D13B500,D13C500 Getr. / GBox: VT2009B		
			 3400 700 463 ⊕ ⊗ 3483 000 348 ⊗ 1878 006 129	430 24 MFZ430 430WGTZ	Mot. D13B500,D13C500 Getr. / GBox: VT2214B, VT2514B Getr. / GBox: VTO2214B, VTO2514B		
			 1863 869 037	72	Mot. D13B500,D13C500 Getr. / GBox: VT2214B, VT2514B Getr. / GBox: VTO2214B, VTO2514B		
		FM 500			 3400 700 600 ⊕ ⊗ 3483 000 348 ⊗ 1878 007 046	430 24 MFZ430	Mot. D13K Getr. / GBox: VT 2514B / VTO 2514B Abgasnorm: Euro 6 / Exhaust Emission Norm: Euro 6 (4)
 3400 710 064 ⊗ 3482 001 169 ⊗ 1878 007 170 ⊗ 6482 000 155	430 24 MFZ430 430WGTZ PHIS-6/38				Mot. D13K Getr. / GBox: AT 2612/E /ATO 2612E Abgasnorm: Euro 6 / Exhaust Emission Norm: Euro 6 (4)		
FM 520	01.08 -	CS43B-O/OR	 3400 700 463 ⊕ ⊗ 3483 000 348 ⊗ 1878 006 129	430 24 MFZ430 430WGTZ	Getr. / GBox: VT2214B, VT2514B Getr. / GBox: VTO2214B, VTO2514B		
			 3400 700 359 ⊖ ⊗ 3482 000 553 ⊗ 1878 006 129	430 24 MF430 430WGTZ	Getr. / GBox: AT2412C, AT2512C Getr. / GBox: ATO2512C		
			 6482 000 155	PHIS-6/38	Getr. / GBox: AT2412C, AT2512C Getr. / GBox: ATO2512C		
		CD38B-O	 3400 700 348 ⊕ ⊗ 3488 019 032 ⊗ 1878 001 216	380 24 GMFZ2/380 380WGVZ			
			 3483 027 332 ⊕	380 GMFZ2/380	In 3483/3488 enthalten / Contained in 3483, 3488	(30)	
			 3482 111 031	380 GMFZ2/380	In 3483/3488 enthalten / Contained in 3483, 3488	(30)	
			 1862 248 033 △	380 8 380GVZ	In 3488 enthalten / Contained in 3488	(31)	
			 3459 017 031	380 GMFZ2/380	In 3488 enthalten / Contained in 3488	(31)	
		CD40B-O	 3400 700 360 ⊕ ⊗ 3488 000 159 ⊗ 1878 003 768	400 24 MFZ2/400X 400WGTZ			
			 3483 034 135 ⊕	400 MFZ2/400X	In 3488 enthalten / Contained in 3488	(31)	
			 3459 018 004	400 MFZ2/400X	In 3488 enthalten / Contained in 3488	(31)	

		CODE					
--	--	------	--	--	---	---	---

VOLVO





















FM 7		08.98 - 12.01						
FM 7/250	08.98 - 12.01	CL43S-0		3400 127 201 ⊕ ⊗ 3483 034 033 ⊗ 1862 530 231	430 10 MFZ430 430WGTZ	Getr. / GBox: R/SR1400		
FM 7/250	08.98 - 12.01			3400 127 101 ⊕ ⊗ 3483 034 034 ⊗ 1878 634 026	430 10 MFZ430 430WGTZ	Getr. / GBox: VT2014,2514		
FM 7/250	08.98 - 12.01				3482 123 234	430 MFZ430	Getr. / GBox: R/SR1400 Getr. / GBox: VT2014,2514 In 3483/3488 enthalten / Contained in 3483, 3488	(30)
FM 7/250	08.98 - 12.01							
FM 7/290	08.98 - 12.01							
FM 7/290	08.98 - 12.01							
FM 7/290	08.98 - 12.01							
FM 7/290	08.98 - 12.01							
FM 7/290	08.98 - 12.01							
FM 7/290	08.98 - 12.01							

FM 9		12.01 - 09.05					
FM 9/260	12.01 - 09.05	CS43B-O/OR		3483 034 033 ⊕	430 MFZ430	Getr. / GBox: VT1708B,VT2009B	
FM 9/260	12.01 - 09.05			3483 034 034 ⊕	430 MFZ430	Getr. / GBox: VT2214B,VTO2214B	
FM 9/300	12.01 - 09.05			3483 034 042 ⊕	430 MFZ430	Getr. / GBox: VT2412B	
FM 9/300	12.01 - 09.05			1878 001 215	430 24 430WGTZ	Getr. / GBox: VT2214B,VTO2214B Getr. / GBox: VT1708B,VT2009B Getr. / GBox: VT2412B	
				3482 123 234	430 MFZ430	Getr. / GBox: VT2214B,VTO2214B Getr. / GBox: VT1708B,VT2009B Getr. / GBox: VT2412B In 3483/3488 enthalten / Contained in 3483, 3488	(30)
FM 9/260	12.01 - 09.05			3400 700 471 ⊕ ⊗ 3483 034 034 ⊗ 1878 001 215	430 24 MFZ430 430WGTZ	Getr. / GBox: VT2214B / VTO2214B Getr. / GBox: VT2514B	
FM 9/260	12.01 - 09.05						
FM 9/260	12.01 - 09.05						
FM 9/260	12.01 - 09.05						
FM 9/260	12.01 - 09.05						
FM 9/260	12.01 - 09.05						
FM 9/260	12.01 - 09.05						
FM 9/300	12.01 - 09.05						
FM 9/300	12.01 - 09.05						
FM 9/300	12.01 - 09.05						
FM 9/300	12.01 - 09.05						
FM 9/300	12.01 - 09.05						
FM 9/300	12.01 - 09.05						
FM 9/300	12.01 - 09.05						
FM 9/300	12.01 - 09.05						
FM 9/340	12.01 - 09.05	CS43B-O/OR		3400 700 342 ⊕ ⊗ 3483 034 033 ⊗ 1878 000 634	430 24 MFZ430 430WGTZ	Getr. / GBox: VT1708B,VT2009B	
FM 9/340	12.01 - 09.05			3482 123 234	430 MFZ430	Getr. / GBox: VT1708B,VT2009B In 3483/3488 enthalten / Contained in 3483, 3488	(30)
FM 9/380	12.01 - 09.05			3400 700 343 ⊕ ⊗ 3483 034 034 ⊗ 1878 000 634	430 24 MFZ430 430WGTZ	Getr. / GBox: VT2214B,VTO2214B	
FM 9/380	12.01 - 09.05			3482 123 234	430 MFZ430	Getr. / GBox: VT2214B,VTO2214B In 3483/3488 enthalten / Contained in 3483, 3488	(30)





















FM 10		09.98 - 12.01					
FM 10/320	04.99 - 12.01	CL43S-O/OR		3400 127 201 ⊕ ⊗ 3483 034 033 ⊗ 1862 530 231	430 10 MFZ430 430WGTZ	Getr. / GBox: S/SR1400/1700	
FM 10/320	04.99 - 12.01			3482 123 234	430 MFZ430	Getr. / GBox: S/SR1400/1700 In 3483/3488 enthalten / Contained in 3483, 3488	(30)
FM 10/360	04.99 - 12.01						
FM 10/360	04.99 - 12.01						

		CODE				
--	--	------	--	---	---	---

VOLVO





















FM 12		08.98 - 09.05						
FM 12/340	08.98 - 09.05	CD38B-O	 3400 700 348 ⊕ ⊗ 3488 019 032 ⊗ 1878 001 216	380 24 GMFZ2/380 380WGVZ	Mot. D12D340 Getr. / GBox: VT2009B			
FM 12/340	08.98 - 09.05		 3483 027 332 ⊕	380 GMFZ2/380	Mot. D12D340 Getr. / GBox: VT2009B In 3483/3488 enthalten / Contained in 3483, 3488	(30)		
FM 12/340	08.98 - 09.05		 3482 111 032	380 GMFZ2/380	Mot. D12D340 Getr. / GBox: VT2009B In 3483/3488 enthalten / Contained in 3483, 3488	(30)		
FM 12/340	08.98 - 09.05		 3459 017 031	380 GMFZ2/380	Mot. D12D340 Getr. / GBox: VT2009B In 3488 enthalten / Contained in 3488	(31)		
FM 12/340	08.98 - 09.05		 1862 248 033 △	380 8 380GVZ	Mot. D12D340 Getr. / GBox: VT2009B In 3488 enthalten / Contained in 3488	(31)		
FM 12/340	08.98 - 09.05		CL39D-C	 3400 700 360 ⊕ ⊗ 3488 000 159 ⊗ 1878 003 768	400 24 MFZ2/400X 400WGTZ			
FM 12H/340	08.98 - 09.05		CD40B-O	 3400 700 422 ⊕ ⊗ 3488 000 024 ⊗ 1878 000 300	400 24 MFZ2/400X 400WGTZ	Mot. D12D340 Getr. / GBox: VT2214B, VTO2214B mit Zwischenring / with intermediate ring	(95)	
		 3400 700 423 ⊕ ⊗ 3483 034 135 ⊗ 1878 000 300 1878 000 635		400 24 MFZ2/400X 400WGTZ 400GTZ	Mot. D12D340 Getr. / GBox: VT2214B, VTO2214B ohne Zwischenring / without intermediate ring	(105)		
		 3459 018 004		400 MFZ2/400X	Mot. D12D340 Getr. / GBox: VT2214B, VTO2214B In 3488 enthalten / Contained in 3488	(31)		
		CL38D-O		 3400 700 427 ⊕ ⊗ 3488 019 032 ⊗ 1862 415 031	380 10 GMFZ2/380 380WGVZ	Mot. D12C340		
			 3400 700 326 ⊕ ⊗ 3483 027 332 ⊗ 1862 248 033 1862 415 031	380 10 GMFZ2/380 380GVZ 380WGVZ	Mot. D12C340 ohne Zwischenring / without intermediate ring	(105)		
			 3482 111 032	380 GMFZ2/380	Mot. D12C340 In 3483/3488 enthalten / Contained in 3483, 3488	(30)		
			 3459 017 031	380 GMFZ2/380	Mot. D12C340 In 3488 enthalten / Contained in 3488	(31)		
		CL40D-O	 3400 700 406 ⊕ ⊗ 3488 022 253 ⊗ 1878 002 437	400 10 MFZ2/400X 400WGTZ	Mot. D12C340 mit Zwischenring / with intermediate ring	(95)		
		CL43S-O	 3400 127 101 ⊕ ⊗ 3483 034 034 ⊗ 1878 634 026	430 10 MFZ430 430WGTZ	Mot. D12C340 Getr. / GBox: VT2014, VT2014OD			
			 3482 123 234	430 MFZ430	Mot. D12C340 Getr. / GBox: VT2014, VT2014OD In 3483/3488 enthalten / Contained in 3483, 3488	(30)		
			 3400 043 032 ⊕ ⊗ 3483 034 033 ⊗ 1878 634 026	430 10 MFZ430 430WGTZ	Mot. D12C340 Getr. / GBox: R/SR1700, 1900			
			 3482 123 234	430 MFZ430	Mot. D12C340 Getr. / GBox: R/SR1700, 1900 In 3483/3488 enthalten / Contained in 3483, 3488	(30)		
		CS43B-O	 3400 700 350 ⊕ ⊗ 3483 034 042 ⊗ 1878 000 634	430 24 MFZ430 430WGTZ	Mot. D12D340 Getr. / GBox: VT2412B			
			 3482 123 234	430 MFZ430	Mot. D12D340 Getr. / GBox: VT2412B In 3483/3488 enthalten / Contained in 3483, 3488	(30)		

VOLVO























FM 12		08.98 - 09.05						
FM 12/380	08.98 - 09.05	CD38B-O	 3400 700 348 ⊕ ⊗ 3488 019 032 ⊗ 1878 001 216	380 24 GMFZ2/380 380WGVZ	Mot. D12D380 Getr. / GBox: VT2009B			
FM 12/380	08.98 - 09.05		 3483 027 332 ⊕	380 GMFZ2/380	Mot. D12D380 Getr. / GBox: VT2009B In 3483/3488 enthalten / Contained in 3483, 3488	(30)		
FM 12/380	08.98 - 09.05		 3482 111 032	380 GMFZ2/380	Mot. D12D380 Getr. / GBox: VT2009B In 3483/3488 enthalten / Contained in 3483, 3488	(30)		
FM 12/380	08.98 - 09.05		 3459 017 031	380 GMFZ2/380	Mot. D12D380 Getr. / GBox: VT2009B In 3488 enthalten / Contained in 3488	(31)		
FM 12/380	08.98 - 09.05		 1862 248 033 △	380 8 380GVZ	Mot. D12D380 Getr. / GBox: VT2009B In 3488 enthalten / Contained in 3488	(31)		
FM 12/380	08.98 - 09.05		CL39D-C	 3400 700 360 ⊕ ⊗ 3488 000 159 ⊗ 1878 003 768	400 24 MFZ2/400X 400WGTZ			
FM 12H/380	08.98 - 09.05		CD40B-O	 3400 700 422 ⊕ ⊗ 3488 000 024 ⊗ 1878 000 300	400 24 MFZ2/400X 400WGTZ	Mot. D12D380 Getr. / GBox: VT2214B, VTO2214B mit Zwischenring / with intermediate ring	(95)	
		 3400 700 423 ⊕ ⊗ 3483 034 135 ⊗ 1878 000 300 1878 000 635		400 24 MFZ2/400X 400WGTZ 400GTZ	Mot. D12D380 Getr. / GBox: VT2214B, VTO2214B ohne Zwischenring / without intermediate ring	(105)		
		 3459 018 004		400 MFZ2/400X	Mot. D12D380 Getr. / GBox: VT2214B, VTO2214B In 3488 enthalten / Contained in 3488	(31)		
		CL38D-O		 3400 700 427 ⊕ ⊗ 3488 019 032 ⊗ 1862 415 031	380 10 GMFZ2/380 380WGVZ	Mot. D12C380		
			 3400 700 326 ⊕ ⊗ 3483 027 332 ⊗ 1862 248 033 1862 415 031	380 10 GMFZ2/380 380GVZ 380WGVZ	Mot. D12C380 ohne Zwischenring / without intermediate ring	(105)		
			 3482 111 032	380 GMFZ2/380	Mot. D12C380 In 3483/3488 enthalten / Contained in 3483, 3488	(30)		
			 3459 017 031	380 GMFZ2/380	Mot. D12C380 In 3488 enthalten / Contained in 3488	(31)		
		CL40D-O	 3400 700 406 ⊕ ⊗ 3488 022 253 ⊗ 1878 002 437	400 10 MFZ2/400X 400WGTZ	Mot. D12C380 mit Zwischenring / with intermediate ring	(95)		
		CL43S-O	 3400 127 101 ⊕ ⊗ 3483 034 034 ⊗ 1878 634 026	430 10 MFZ430 430WGTZ	Mot. D12C380 Getr. / GBox: VT2014, VT2014OD			
			 3482 123 234	430 MFZ430	Mot. D12C380 Getr. / GBox: VT2014, VT2014OD In 3483/3488 enthalten / Contained in 3483, 3488	(30)		
			 3400 043 032 ⊕ ⊗ 3483 034 033 ⊗ 1878 634 026	430 10 MFZ430 430WGTZ	Mot. D12C380 Getr. / GBox: R/SR1700, 1900			
			 3482 123 234	430 MFZ430	Mot. D12C380 Getr. / GBox: R/SR1700, 1900 In 3483/3488 enthalten / Contained in 3483, 3488	(30)		
		CS43B-O	 3400 700 350 ⊕ ⊗ 3483 034 042 ⊗ 1878 000 634	430 24 MFZ430 430WGTZ	Mot. D12D380 Getr. / GBox: VT2412B			
			 3482 123 234	430 MFZ430	Mot. D12D380 Getr. / GBox: VT2412B In 3483/3488 enthalten / Contained in 3483, 3488	(30)		

		CODE				
--	--	------	--	---	---	---

VOLVO

FM 12		08.98 - 09.05						
FM 12/420	08.98 - 09.05	CD38B-O	 3400 700 348 ⊕ ⊗ 3488 019 032 ⊗ 1878 001 216	380 24 GMFZ2/380 380WGVZ	Mot. D12D420 Getr. / GBox: VT2009B			
FM 12/420	08.98 - 09.05		 3483 027 332 ⊕	380 GMFZ2/380	Mot. D12D420 Getr. / GBox: VT2009B In 3483/3488 enthalten / Contained in 3483, 3488	(30)		
FM 12/420	08.98 - 09.05		 3482 111 032	380 GMFZ2/380	Mot. D12D420 Getr. / GBox: VT2009B In 3483/3488 enthalten / Contained in 3483, 3488	(30)		
FM 12/420	08.98 - 09.05		 3459 017 031	380 GMFZ2/380	Mot. D12D420 Getr. / GBox: VT2009B In 3488 enthalten / Contained in 3488	(31)		
FM 12/420	08.98 - 09.05		 1862 248 033 △	380 8 380GVZ	Mot. D12D420 Getr. / GBox: VT2009B In 3488 enthalten / Contained in 3488	(31)		
FM 12/420	08.98 - 09.05		CL39D-C	 3400 700 360 ⊕ ⊗ 3488 000 159 ⊗ 1878 003 768	400 24 MFZ2/400X 400WGTZ			
FM 12H/420	08.98 - 09.05		CD40B-O	 3400 700 422 ⊕ ⊗ 3488 000 024 ⊗ 1878 000 300	400 24 MFZ2/400X 400WGTZ	Mot. D12D420 Getr. / GBox: VT2214B, VTO2214B mit Zwischenring / with intermediate ring	(95)	
		 3400 700 423 ⊕ ⊗ 3483 034 135 ⊗ 1878 000 300 1878 000 635		400 24 MFZ2/400X 400WGTZ 400GTZ	Mot. D12D420 Getr. / GBox: VT2214B, VTO2214B ohne Zwischenring / without intermediate ring	(105)		
		 3459 018 004		400 MFZ2/400X	Mot. D12D420 Getr. / GBox: VT2214B, VTO2214B In 3488 enthalten / Contained in 3488	(31)		
		CL38D-O		 3400 700 427 ⊕ ⊗ 3488 019 032 ⊗ 1862 415 031	380 10 GMFZ2/380 380WGVZ	Mot. D12C420		
			 3400 700 326 ⊕ ⊗ 3483 027 332 ⊗ 1862 248 033 1862 415 031	380 10 GMFZ2/380 380GVZ 380WGVZ	Mot. D12C420 ohne Zwischenring / without intermediate ring	(105)		
			 3482 111 032	380 GMFZ2/380	Mot. D12C420 In 3483/3488 enthalten / Contained in 3483, 3488	(30)		
			 3459 017 031	380 GMFZ2/380	Mot. D12C420 In 3488 enthalten / Contained in 3488	(31)		
		CL40D-O	 3400 700 406 ⊕ ⊗ 3488 022 253 ⊗ 1878 002 437	400 10 MFZ2/400X 400WGTZ	Mot. D12C420 mit Zwischenring / with intermediate ring	(95)		
		CL43S-O	 3400 127 101 ⊕ ⊗ 3483 034 034 ⊗ 1878 634 026	430 10 MFZ430 430WGTZ	Mot. D12C420 Getr. / GBox: VT2014, VT2014OD			
			 3482 123 234	430 MFZ430	Mot. D12C420 Getr. / GBox: VT2014, VT2014OD In 3483/3488 enthalten / Contained in 3483, 3488	(30)		
			 3400 043 032 ⊕ ⊗ 3483 034 033 ⊗ 1878 634 026	430 10 MFZ430 430WGTZ	Mot. D12C420 Getr. / GBox: R/SR1700, 1900			
			 3482 123 234	430 MFZ430	Mot. D12C420 Getr. / GBox: R/SR1700, 1900 In 3483/3488 enthalten / Contained in 3483, 3488	(30)		
		CS43B-O	 3400 700 350 ⊕ ⊗ 3483 034 042 ⊗ 1878 000 634	430 24 MFZ430 430WGTZ	Mot. D12D420 Getr. / GBox: VT2412B			
			 3482 123 234	430 MFZ430	Mot. D12D420 Getr. / GBox: VT2412B In 3483/3488 enthalten / Contained in 3483, 3488	(30)		























VOLVO

FM 12		08.98 - 09.05				
FM 12/460 4x2	01.03-	CD38B-O	 3400 700 348 ⊕ ⊗ 3488 019 032 ⊗ 1878 001 216	380 24 GMFZ2/380 380WGVZ	Mot. D12D460 Getr. / GBox: VT2009B	
FM 12/460 4x2	01.03-		 3483 027 332 ⊕	380 GMFZ2/380	Mot. D12D460 Getr. / GBox: VT2009B In 3483/3488 enthalten / Contained in 3483, 3488	(30)
FM 12/460 6x2	01.03-		 3482 111 032	380 GMFZ2/380	Mot. D12D460 Getr. / GBox: VT2009B In 3483/3488 enthalten / Contained in 3483, 3488	(30)
FM 12/460 6x2	01.03-		 3459 017 031	380 GMFZ2/380	Mot. D12D460 Getr. / GBox: VT2009B In 3488 enthalten / Contained in 3488	(31)
FM 12/460 6x4	01.03-		 1862 248 033 Δ	380 8 380GVZ	Mot. D12D460 Getr. / GBox: VT2009B In 3488 enthalten / Contained in 3488	(31)
FM 12/460 6x4	01.03-					
FM 12/460 8x2/4	01.03-	CL39D-C	 3400 700 360 ⊕ ⊗ 3488 000 159 ⊗ 1878 003 768	400 24 MFZ2/400X 400WGTZ		
FM 12/460 8x4/4	01.03-	CD40B-O	 3400 700 422 ⊕ ⊗ 3488 000 024 ⊗ 1878 000 300	400 24 MFZ2/400X 400WGTZ	Mot. D12D460 Getr. / GBox: VT2214B, VTO2214B mit Zwischenring / with intermediate ring	(95)
			 3400 700 423 ⊕ ⊗ 3483 034 135 ⊗ 1878 000 300 1878 000 635	400 24 MFZ2/400X 400WGTZ 400GTZ	Mot. D12D460 Getr. / GBox: VT2214B, VTO2214B ohne Zwischenring / without intermediate ring	(105)
			 3459 018 004	400 MFZ2/400X	Mot. D12D460 Getr. / GBox: VT2214B, VTO2214B In 3488 enthalten / Contained in 3488	(31)
		CL38D-O	 3400 700 427 ⊕ ⊗ 3488 019 032 ⊗ 1862 415 031	380 10 GMFZ2/380 380WGVZ	Mot. D12C460	
			 3400 700 326 ⊕ ⊗ 3483 027 332 ⊗ 1862 248 033 1862 415 031	380 10 GMFZ2/380 380GVZ 380WGVZ	Mot. D12C460 ohne Zwischenring / without intermediate ring	(105)
			 3482 111 032	380 GMFZ2/380	Mot. D12C460 In 3483/3488 enthalten / Contained in 3483, 3488	(30)
			 3459 017 031	380 GMFZ2/380	Mot. D12C460 In 3488 enthalten / Contained in 3488	(31)
		CL40D-O	 3400 700 406 ⊕ ⊗ 3488 022 253 ⊗ 1878 002 437	400 10 MFZ2/400X 400WGTZ	Mot. D12C460 mit Zwischenring / with intermediate ring	(95)
		CL43S-O	 3400 127 101 ⊕ ⊗ 3483 034 034 ⊗ 1878 634 026	430 10 MFZ430 430WGTZ	Mot. D12C460 Getr. / GBox: VT2014, VT2014OD	
			 3482 123 234	430 MFZ430	Mot. D12C460 Getr. / GBox: VT2014, VT2014OD In 3483/3488 enthalten / Contained in 3483, 3488	(30)
			 3400 043 032 ⊕ ⊗ 3483 034 033 ⊗ 1878 634 026	430 10 MFZ430 430WGTZ	Mot. D12C460 Getr. / GBox: R/SR1700, 1900	
			 3482 123 234	430 MFZ430	Mot. D12C460 Getr. / GBox: R/SR1700, 1900 In 3483/3488 enthalten / Contained in 3483, 3488	(30)
		CS43B-O	 3400 700 351 ⊕ ⊗ 3483 034 043 ⊗ 1878 006 129	430 24 MFZ430 430WGTZ	Mot. D12D460 Getr. / GBox: VT2412B	
		CS43B-O/OR	 3400 700 342 ⊕ ⊗ 3483 034 033 ⊗ 1878 000 634	430 24 MFZ430 430WGTZ	Mot. D12D460 Getr. / GBox: VT2009B	
			 3482 123 234	430 MFZ430	Mot. D12D460 Getr. / GBox: VT2009B In 3483/3488 enthalten / Contained in 3483, 3488	(30)
			 3400 700 343 ⊕ ⊗ 3483 034 034 ⊗ 1878 000 634	430 24 MFZ430 430WGTZ	Mot. D12D460 Getr. / GBox: VT2214B, VTO2214B	
			 3482 123 234	430 MFZ430	Mot. D12D460 Getr. / GBox: VT2214B, VTO2214B In 3483/3488 enthalten / Contained in 3483, 3488	(30)

		CODE				
--	--	------	--	---	---	---

VOLVO

















FMX 04.10 -

330	04.10-	CD38B-O		3400 700 348 ⊕ ⊗ 3488 019 032 ⊗ 1878 001 216	380 24 GMFZ2/380 380WGVZ	Mot. D11C330	
330	04.10-			1863 869 037	72	Mot. D11C330	
330	04.10-	CD40B-O		3400 700 360 ⊕ ⊗ 3488 000 159 ⊗ 1878 003 768	400 24 MFZ2/400X 400WGTZ	Mot. D11C330 Getr. / GBox: VT2214B, VT2514B Getr. / GBox: VTO2214B, VTO2514B	
330	04.10-			1863 869 037	72	Mot. D11C330 Getr. / GBox: VT2214B, VT2514B Getr. / GBox: VTO2214B, VTO2514B	
330	04.10-	CS43B-O		3400 700 358 ⊖ ⊗ 3482 000 552 ⊗ 1878 003 867	430 24 MF430 430WGTZ	Mot. D11C330 Getr. / GBox: AT2412D, AT2612D Getr. / GBox: ATO2612D	
330	04.10-			6482 000 155	PHIS-6/38	Mot. D11C330 Getr. / GBox: AT2412D, AT2612D Getr. / GBox: ATO2612D	
330	04.10-			1863 869 037	72	Mot. D11C330 Getr. / GBox: AT2412D, AT2612D Getr. / GBox: ATO2612D	
330	04.10-	CS43B-OR		3400 700 478 ⊕ ⊗ 3483 000 382 ⊗ 1878 006 129	430 24 MFZ430 430WGTZ	Mot. D11C330 Getr. / GBox: VT2009B	
330	04.10-			1863 869 037	72	Mot. D11C330 Getr. / GBox: VT2009B	
330	04.10-			3400 700 463 ⊕ ⊗ 3483 000 348 ⊗ 1878 006 129	430 24 MFZ430 430WGTZ	Mot. D11C330 Getr. / GBox: VT2214B, VT2514B Getr. / GBox: VTO2214B, VTO2514B	
330	04.10-			1863 869 037	72	Mot. D11C330 Getr. / GBox: VT2214B, VT2514B Getr. / GBox: VTO2214B, VTO2514B	
380	04.10-	CD38B-O		3400 700 348 ⊕ ⊗ 3488 019 032 ⊗ 1878 001 216	380 24 GMFZ2/380 380WGVZ	Mot. D13C380	
380	04.10-			1863 869 037	72	Mot. D13C380	
380	04.10-	CD40B-O		3400 700 360 ⊕ ⊗ 3488 000 159 ⊗ 1878 003 768	400 24 MFZ2/400X 400WGTZ	Mot. D13C380 Getr. / GBox: VT2214B, VT2514B Getr. / GBox: VTO2214B, VTO2514B	
380	04.10-			1863 869 037	72	Mot. D13C380 Getr. / GBox: VT2214B, VT2514B Getr. / GBox: VTO2214B, VTO2514B	
380	04.10-	CS43B-O		3400 700 359 ⊖ ⊗ 3482 000 553 ⊗ 1878 006 129	430 24 MF430 430WGTZ	Mot. D13C380 Getr. / GBox: AT2412D, AT2612D Getr. / GBox: ATO2612D	
380	04.10-			6482 000 155	PHIS-6/38	Mot. D13C380 Getr. / GBox: AT2412D, AT2612D Getr. / GBox: ATO2612D	
380	04.10-			1863 869 037	72	Mot. D13C380 Getr. / GBox: AT2412D, AT2612D Getr. / GBox: ATO2612D	
380	04.10-	CS43B-OR		3400 700 478 ⊕ ⊗ 3483 000 382 ⊗ 1878 006 129	430 24 MFZ430 430WGTZ	Mot. D13C380 Getr. / GBox: VT2009B	
380	04.10-			1863 869 037	72	Mot. D13C380 Getr. / GBox: VT2009B	
380	04.10-			3400 700 463 ⊕ ⊗ 3483 000 348 ⊗ 1878 006 129	430 24 MFZ430 430WGTZ	Mot. D13C380 Getr. / GBox: VT2214B, VT2514B Getr. / GBox: VTO2214B, VTO2514B	
380	04.10-			1863 869 037	72	Mot. D13C380 Getr. / GBox: VT2214B, VT2514B Getr. / GBox: VTO2214B, VTO2514B	

FS 7 11.91 - 03.96

Mot. TD 71, 73	01.85-	KFD116A		3400 700 301 #⊕ ⊗ 3483 022 031 ⊗ 1862 349 031	400 10 MFZ400X 400GVZ		
				3482 101 032	400 MFZ400X	In 3483/3488 enthalten / Contained in 3483, 3488	(30)
FS 7 FS 718/230 FS 718/260	01.90-12.96 09.94-03.96 09.94-03.96	KFD116A, B		3400 700 301 #⊕ ⊗ 3483 022 031 ⊗ 1862 349 031	400 10 MFZ400X 400GVZ	Getr. / GBox: R1000,SR1400	
				3482 101 032	400 MFZ400X	Getr. / GBox: R1000,SR1400 In 3483/3488 enthalten / Contained in 3483, 3488	(30)
		KFD116C		3482 101 032	400	Getr. / GBox: R800	















VOLVO

G - Serie							
G 88		<u>1878 000 967</u> ▾	380 10 380GTZ	Mot. TD 100 A Getr. / GBox: MR61 Lose Kupplungsscheibe / Loose clutch disc	(39)		
		<u>3151 106 041</u>	KZI-5	Mot. TD 100 A Getr. / GBox: MR61			
		<u>1882 280 213</u>	380 GF2/380	Mot. TD 100 A Getr. / GBox: MR61 In 1888 enthalten / Contained in 1888	(29)		
		<u>1859 212 000</u>	380 GF2/380	Mot. TD 100 A Getr. / GBox: MR61 In 1888 enthalten / Contained in 1888	(29)		
		<u>1878 000 964</u> △	380 10 380GTZ	Mot. TD 100 A Getr. / GBox: MR61 In 1888 enthalten / Contained in 1888	(29)		
		<u>1800 125 601</u> # ● <u>1882 226 533</u> ● <u>1861 672 033</u> ○ <u>3151 105 141</u>	420 G420 420GSZ KZI-5	Mot. T 100A, B ;TD 100A Getr. / GBox: R 61, SR 61			
G 88 6x2 LHD		<u>1878 000 967</u> ▾	380 10 380GTZ	Chass. 33995 - Chass. 46790 Mot. TD 100 A Getr. / GBox: R61, SR61 Lose Kupplungsscheibe / Loose clutch disc	(39)		
		<u>3151 106 041</u>	KZI-5	Chass. 33995 - Chass. 46790 Mot. TD 100 A Getr. / GBox: R61, SR61			
		<u>1882 280 213</u>	380 GF2/380	Chass. 33995 - Chass. 46790 Mot. TD 100 A Getr. / GBox: R61, SR61 In 1888 enthalten / Contained in 1888	(29)		
		<u>1859 212 000</u>	380 GF2/380	Chass. 33995 - Chass. 46790 Mot. TD 100 A Getr. / GBox: R61, SR61 In 1888 enthalten / Contained in 1888	(29)		
		<u>1878 000 964</u> △	380 10 380GTZ	Chass. 33995 - Chass. 46790 Mot. TD 100 A Getr. / GBox: R61, SR61 In 1888 enthalten / Contained in 1888	(29)		
		<u>1888 019 445</u> #	350 GF2/350	Chass. 46791-> für / for: 6x2,6x4 RHD Mot. TD 100 A enthält eine Kupplungsscheibe / This part number includes one clutch disc	(68) (66)		
		<u>1878 001 083</u> ▾	350 10 350GTZ	Chass. 46791-> für / for: 6x2,6x4 RHD Mot. TD 100 A Lose Kupplungsscheibe / Loose clutch disc	(68) (39)		
		<u>3151 106 041</u>	KZI-5	Chass. 46791-> für / for: 6x2,6x4 RHD Mot. TD 100 A	(68)		
		<u>1882 250 143</u>	350 GF2/350	Chass. 46791-> für / for: 6x2,6x4 RHD Mot. TD 100 A In 1888 enthalten / Contained in 1888	(68) (29)		
		<u>1859 170 204</u>	350 GF2/350	Chass. 46791-> für / for: 6x2,6x4 RHD Mot. TD 100 A In 1888 enthalten / Contained in 1888	(68) (29)		
		<u>1878 001 079</u> △	350 10 350GTZ	Chass. 46791-> für / for: 6x2,6x4 RHD Mot. TD 100 A In 1888 enthalten / Contained in 1888	(68) (29)		



















		CODE				
--	--	------	--	---	---	---

VOLVO

G - Serie







































G 88 6x2,6x4 RHD			 1878 000 967 ▽	380 10 380GTZ	Chass. 33995 - Chass. 40395 Chass. 42121 - Chass. 46790 Mot. TD 100 A Getr. / GBox: R61, SR61 Lose Kupplungsscheibe / Loose clutch disc	(39)
			 3151 106 041	KZI-5	Chass. 33995 - Chass. 40395 Chass. 42121 - Chass. 46790 Mot. TD 100 A Getr. / GBox: R61, SR61	
			 1882 280 213	380 GF2/380	Chass. 33995 - Chass. 40395 Chass. 42121 - Chass. 46790 Mot. TD 100 A Getr. / GBox: R61, SR61 In 1888 enthalten / Contained in 1888	(29)
			 1859 212 000	380 GF2/380	Chass. 33995 - Chass. 40395 Chass. 42121 - Chass. 46790 Mot. TD 100 A Getr. / GBox: R61, SR61 In 1888 enthalten / Contained in 1888	(29)
			 1878 000 964 △	380 10 380GTZ	Chass. 33995 - Chass. 40395 Chass. 42121 - Chass. 46790 Mot. TD 100 A Getr. / GBox: R61, SR61 In 1888 enthalten / Contained in 1888	(29)
G 89			 1800 125 601 #  1882 226 533  1861 672 033  3151 105 141	420 G420 420GSZ KZI-5	Mot. TD 110, 120 A	
			 1878 000 967 ▽	380 10 380GTZ	Mot. TD 120 A Lose Kupplungsscheibe / Loose clutch disc	(39)
			 3151 106 041	KZI-5	Mot. TD 120 A	
			 1882 280 213	380 GF2/380	Mot. TD 120 A In 1888 enthalten / Contained in 1888	(29)
			 1859 212 000	380 GF2/380	Mot. TD 120 A In 1888 enthalten / Contained in 1888	(29)
			 1878 000 964 △	380 10 380GTZ	Mot. TD 120 A In 1888 enthalten / Contained in 1888	(29)

N 7 01.70 - 09.80

Mot. TD 70	01.73 -	KF115B, KV115B	 3400 037 032  3482 021 031  1878 000 961  3151 824 005	380 10 GM380 380GTZ KZA-4	Getr. / GBox: R52, R52B		
			KF214C	 1888 019 445 #	350 GF2/350	Getr. / GBox: R51, 52, R52B enthält eine Kupplungsscheibe / This part number includes one clutch disc	(66)
				 1878 001 083 ▽	350 10 350GTZ	Getr. / GBox: R51, 52, R52B Lose Kupplungsscheibe / Loose clutch disc	(39)
		 3151 600 533		KZA-4	Getr. / GBox: R51, 52, R52B		
		 1859 170 204		350 GF2/350	Getr. / GBox: R51, 52, R52B In 1888 enthalten / Contained in 1888	(29)	
		KF214F	 1800 106 033  1882 250 143  1878 001 080  1878 001 082  3151 106 041  1874 000 098	350 10 GF2/350 350GTZ 350GTZ KZI-5	Getr. / GBox: SR62 ohne Zwischenring / without intermediate ring	(105)	
			 1888 019 542 #	350 GF2/350	Getr. / GBox: SR62 enthält eine Kupplungsscheibe / This part number includes one clutch disc	(66)	
			 1878 001 082 ▽	350 10 350GTZ	Getr. / GBox: SR62 Lose Kupplungsscheibe / Loose clutch disc	(39)	
			 3151 106 041	KZI-5	Getr. / GBox: SR62		
			 1859 170 204	350 GF2/350	Getr. / GBox: SR62 In 1888 enthalten / Contained in 1888	(29)	
		KF115	 1882 325 134	380 G380	Getr. / GBox: R51		

		CODE				
--	--	------	--	---	---	---







VOLVO

N 10		01.73 - 12.89							
Mot. TD 100	01.73-12.83	KF116	 1800 125 601 #  1882 226 533  1861 672 033  3151 105 141	420 G420 420GSZ KZI-5	Getr. / GBox: R/SR61				
		KF214E	 1888 019 445 #	350 GF2/350	Getr. / GBox: R/SR61 enthält eine Kupplungsscheibe / This part number includes one clutch disc	(66)			
			 1878 001 083 ▽	350 10 350GTZ	Getr. / GBox: R/SR61 Lose Kupplungsscheibe / Loose clutch disc	(39)			
			 3151 106 041	KZI-5	Getr. / GBox: R/SR61				
			 1882 250 143	350 GF2/350	Getr. / GBox: R/SR61 In 1888 enthalten / Contained in 1888	(29)			
			 1859 170 204	350 GF2/350	Getr. / GBox: R/SR61 In 1888 enthalten / Contained in 1888	(29)			
			 1878 001 079 △	350 10 350GTZ	Getr. / GBox: R/SR61 In 1888 enthalten / Contained in 1888	(29)			
		KF215B	 1878 000 967 ▽	380 10 380GTZ	Getr. / GBox: MR61 Lose Kupplungsscheibe / Loose clutch disc	(39)			
			 3151 106 041	KZI-5	Getr. / GBox: MR61				
			 1882 280 213	380 GF2/380	Getr. / GBox: MR61 In 1888 enthalten / Contained in 1888	(29)			
			 1859 212 000	380 GF2/380	Getr. / GBox: MR61 In 1888 enthalten / Contained in 1888	(29)			
			 1878 000 964 △	380 10 380GTZ	Getr. / GBox: MR61 In 1888 enthalten / Contained in 1888	(29)			
		Mot. TD 100	01.73-	KF215L	 1888 015 515 #	380 10 GF2/380	Getr. / GBox: MR62 enthält eine Kupplungsscheibe / This part number includes one clutch disc	(66)	
					 1878 000 968 ▽	380 10 380GTZ	Getr. / GBox: MR62 Lose Kupplungsscheibe / Loose clutch disc	(39)	
					 3151 106 041	KZI-5	Getr. / GBox: MR62		
 1882 280 213	380 GF2/380				Getr. / GBox: MR62 In 1888 enthalten / Contained in 1888	(29)			
 1859 212 000	380 GF2/380				Getr. / GBox: MR62 In 1888 enthalten / Contained in 1888	(29)			
Mot. TD 100, 101, 102	01.73-	KF214F, H	 1800 106 033  1882 250 143  1878 001 080  1878 001 082  3151 106 041  1874 000 098	350 10 GF2/350 350GTZ 350GTZ KZI-5	Getr. / GBox: R/SR62 ohne Zwischenring / without intermediate ring	(105)			
			 1888 019 542 #	350 GF2/350	Getr. / GBox: R/SR62 enthält eine Kupplungsscheibe / This part number includes one clutch disc	(66)			
			 1878 001 082 ▽	350 10 350GTZ	Getr. / GBox: R/SR62 Lose Kupplungsscheibe / Loose clutch disc	(39)			
			 3151 106 041	KZI-5	Getr. / GBox: R/SR62				
			 1859 170 204	350 GF2/350	Getr. / GBox: R/SR62 In 1888 enthalten / Contained in 1888	(29)			
		KF116B	 3482 119 032	430 GMF430	Getr. / GBox: R/SR62				
			 1878 003 242	420 10 420GTZ	Getr. / GBox: R/SR62				
			 3151 105 141	KZI-5	Getr. / GBox: R/SR62				
			Mot. TD 100, 101, 102	01.77-	KF215K	 1882 280 140	380 GF2/380	Getr. / GBox: MR62B	
						 1859 212 000	380 GF2/380	Getr. / GBox: MR62B	
 1878 000 968 ▽	380 10 380GTZ	Getr. / GBox: MR62B							
 1878 000 965 △	380 10 380GTZ	Getr. / GBox: MR62B							
 3151 106 041	KZI-5	Getr. / GBox: MR62B							

















		CODE					
--	--	------	--	--	---	---	---

VOLVO

N 10 01.73 - 12.89









































Mot. TD 101, 102	01.80-	KFD117B, C		3400 106 031 ⊕ ⊗ 3483 034 032 ⊗ 1862 530 231	430 10 MFZ430 430WGTZ	Getr. / GBox: R/SR1400, 1700	
				3400 040 032 ●⊕ ⊗ 3483 034 032 ⊗ 1861 988 040	430 10 MFZ430 430GVZ	Getr. / GBox: R/SR1400, 1700	
				3482 123 235	430 MFZ430	Getr. / GBox: R/SR1400, 1700 In 3483/3488 enthalten / Contained in 3483, 3488	(30)
Mot. TD 101, 102	01.86-	KFD214A		3400 031 033 ⊕ ⊗ 3483 014 132 ⊗ 1878 001 080 ⊗ 1878 001 082 ⊗ 3474 012 000	350 10 GMFZ2/350 350GTZ 350GTZ	Getr. / GBox: R/SR1400, 1700 ohne Zwischenring / without intermediate ring	(105)
				3488 013 138 ⊕	350 GMFZ2/350	Getr. / GBox: R/SR1400, 1700 enthält eine Kupplungsscheibe / This part number includes one clutch disc	(66)
				1878 001 082 ▽	350 10 350GTZ	Getr. / GBox: R/SR1400, 1700 Lose Kupplungsscheibe / Loose clutch disc	(39)
				3482 056 031	350 GMFZ2/350	Getr. / GBox: R/SR1400, 1700 In 3483/3488 enthalten / Contained in 3483, 3488	(30)
				3459 000 009	350 GMFZ2/350	Getr. / GBox: R/SR1400, 1700 In 3483/3488 enthalten / Contained in 3483, 3488	(30)

N 12 01.70 - 09.80

Mot. TD 120	01.73-12.83	KF215B		1878 000 967 ▽	380 10 380GTZ	Getr. / GBox: R/SR61, MR61B Lose Kupplungsscheibe / Loose clutch disc	(39)
				3151 106 041	KZI-5	Getr. / GBox: R/SR61, MR61B	
				1882 280 213	380 GF2/380	Getr. / GBox: R/SR61, MR61B In 1888 enthalten / Contained in 1888	(29)
				1859 212 000	380 GF2/380	Getr. / GBox: R/SR61, MR61B In 1888 enthalten / Contained in 1888	(29)
				1878 000 964 △	380 10 380GTZ	Getr. / GBox: R/SR61, MR61B In 1888 enthalten / Contained in 1888	(29)
Mot. TD 120, 121	01.73-	KF215K		1882 280 140	380 GF2/380	Getr. / GBox: MR62B	
				1859 212 000	380 GF2/380	Getr. / GBox: MR62B	
				1878 000 968 ▽	380 10 380GTZ	Getr. / GBox: MR62B	
				1878 000 965 △	380 10 380GTZ	Getr. / GBox: MR62B	
				3151 106 041	KZI-5	Getr. / GBox: MR62B	
Mot. TD 120, 121, 122	01.73-	KF215F		1888 015 515 #	380 10 GF2/380	Getr. / GBox: R/SR62 Getr. / GBox: R/SR70 enthält eine Kupplungsscheibe / This part number includes one clutch disc	(66)
				1878 000 968 ▽	380 10 380GTZ	Getr. / GBox: R/SR62 Getr. / GBox: R/SR70 Lose Kupplungsscheibe / Loose clutch disc	(39)
				3151 106 041	KZI-5	Getr. / GBox: R/SR62	
				1882 280 213	380 GF2/380	Getr. / GBox: R/SR62 Getr. / GBox: R/SR70 In 1888 enthalten / Contained in 1888	(29)
				1859 212 000	380 GF2/380	Getr. / GBox: R/SR70 Getr. / GBox: R/SR62 In 1888 enthalten / Contained in 1888	(29)
				1878 000 965 △	380 10 380GTZ	Getr. / GBox: R/SR62 Getr. / GBox: R/SR70 In 1888 enthalten / Contained in 1888	(29)







		CODE					
--	--	------	--	--	---	---	---







VOLVO



N 12		01.70 - 09.80					
Mot. TD 121, 122	01.83-	KF215D, G	 3400 116 501  3482 026 332  1861 907 132  1861 996 137  3151 106 041  1874 000 098	380 10 GTF380 380GSZ 380GVZ KZI-5	Getr. / GBox: R/SR70,71 ohne Zwischenring / without intermediate ring	(105)	
			 3488 007 631	380 GTF2/380	Getr. / GBox: R/SR70,71 enthält eine Kupplungsscheibe / This part number includes one clutch disc	(66)	
			 1861 996 137 ▽	380 10 380GVZ	Getr. / GBox: R/SR70,71 Lose Kupplungsscheibe / Loose clutch disc	(39)	
			 3151 106 041	KZI-5	Getr. / GBox: R/SR70,71		
			 3459 004 108	380 GTF2/380	Getr. / GBox: R/SR70,71 In 3488 enthalten / Contained in 3488	(31)	
Mot. TD 121, 122	01.86-	KFD214A	 3400 031 033 ⊕  3483 014 132  1878 001 080  1878 001 082  3474 012 000	350 10 GMFZ2/350 350GTZ 350GTZ	Getr. / GBox: R/SR1400, 1700 ohne Zwischenring / without intermediate ring	(105)	
			 3488 013 138 ⊕	350 GMFZ2/350	Getr. / GBox: R/SR1400, 1700 enthält eine Kupplungsscheibe / This part number includes one clutch disc	(66)	
			 1878 001 082 ▽	350 10 350GTZ	Getr. / GBox: R/SR1400, 1700 Lose Kupplungsscheibe / Loose clutch disc	(39)	
			 3482 056 031	350 GMFZ2/350	Getr. / GBox: R/SR1400, 1700 In 3483/3488 enthalten / Contained in 3483, 3488	(30)	
			 3459 000 009	350 GMFZ2/350	Getr. / GBox: R/SR1400, 1700 In 3483/3488 enthalten / Contained in 3483, 3488	(30)	
		KFD215A	 3400 030 033 #⊕  3483 017 031  1861 996 137  1861 997 137  3474 012 001	380 10 GMFZ2/380 380GVZ 380GVZ	Getr. / GBox: R/SR1400, 1700 ohne Zwischenring / without intermediate ring	(105)	
			 3482 059 031	380 GMFZ2/380	Getr. / GBox: R/SR1400, 1700 In 3483/3488 enthalten / Contained in 3483, 3488	(30)	
			 3459 010 101	380 GMFZ2/380	Getr. / GBox: R/SR1400, 1700		
			 3400 700 427 ⊕  3488 019 032  1862 415 031	380 10 GMFZ2/380 380WGVZ	Getr. / GBox: R/SR1400, 1700		
			 3400 700 326 ⊕  3483 027 332  1862 248 033  1862 415 031	380 10 GMFZ2/380 380GVZ 380WGVZ	Getr. / GBox: R/SR1400, 1700 ohne Zwischenring / without intermediate ring	(105)	
			 3482 111 032	380 GMFZ2/380	Getr. / GBox: R/SR1400, 1700 In 3483/3488 enthalten / Contained in 3483, 3488	(30)	
			 3459 017 031	380 GMFZ2/380	Getr. / GBox: R/SR1400, 1700 In 3488 enthalten / Contained in 3488	(31)	
			N 88				
N 88			 1800 125 601 #  1882 226 533  1861 672 033  3151 105 141	420 G420 420GSZ KZI-5	Mot. TD100, D100, B nicht für / not for: 3 Achsen/Axes	(96)	
NB - Serie							
NB 86 bis 32 t Gesamtgewicht / to 32t total weight			 1882 325 134	380 G380	Mot. TD 70		
			 3151 824 005	KZA-4	Mot. TD 70		





		CODE				
--	--	------	--	---	---	---

VOLVO

NB - Serie							
NB 86 über 32 t Gesamtgewicht / from 32t total weight				1800 125 001 ⊕ 1882 250 143 ⊕ 1878 001 079 ⊕ 1878 001 083 ⊕ 3151 600 533 ⊕ 1874 000 098	350 10 GF2/350 350GTZ 350GTZ KZA-4	Mot. TD 70, E, EF ohne Zwischenring / without intermediate ring	(105)
				1888 019 445 #	350 GF2/350	Mot. TD 70, E, EF enthält eine Kupplungsscheibe / This part number includes one clutch disc	(66)
				1878 001 083 ▽	350 10 350GTZ	Mot. TD 70, E, EF Lose Kupplungsscheibe / Loose clutch disc	(39)
				3151 600 533	KZA-4	Mot. TD 70, E, EF	
				1859 170 204	350 GF2/350	Mot. TD 70, E, EF In 1888 enthalten / Contained in 1888	(29)
NB 88				1800 125 601 # ⊕ 1882 226 533 ⊕ 1861 672 033 ⊕ 3151 105 141	420 G420 420GSZ KZI-5	Mot. TD100, D100, B nicht für / not for: 3 Achsen/Axes	(96)







NH 12 05.99 -							
NH 12 NH 12/380 NH 12/380 NH 12/420	05.99 - 05.99 - 05.99 - 05.99 -	CD40B-O		3400 700 422 ⊕ ⊕ 3488 000 024 ⊕ 1878 000 300	400 24 MFZ2/400X 400WGTZ	für Fahrzeuge mit Zweischeibenkupplung / for vehicles with double disc clutch mit Zwischenring / with intermediate ring	(77) (95)
				3400 043 032 ⊕ ⊕ 3483 034 033 ⊕ 1878 634 026	430 10 MFZ430 430WGTZ		
		CS43B-O		3400 700 350 ⊕ ⊕ 3483 034 042 ⊕ 1878 000 634	430 24 MFZ430 430WGTZ	Getr. / GBox: VT2412B max. übertragbares Motormoment [Nm] / max. transmittable engine torque [Nm]: 2040	(87)
				3400 700 351 ⊕ ⊕ 3483 034 043 ⊕ 1878 006 129	430 24 MFZ430 430WGTZ	Getr. / GBox: VT2412B max. übertragbares Motormoment [Nm] / max. transmittable engine torque [Nm]: 2400	(87)
		CS43B-O, CS43B-OR		3400 700 343 ⊕ ⊕ 3483 034 034 ⊕ 1878 000 634	430 24 MFZ430 430WGTZ	Getr. / GBox: VT2214B/VTO2214B Getr. / GBox: VT2514B/VTO2514B max. übertragbares Motormoment [Nm] / max. transmittable engine torque [Nm]: 2040	(87)
				3400 700 357 ⊕ ⊕ 3483 034 035 ⊕ 1878 006 129	430 24 MFZ430 430WGTZ	Getr. / GBox: VT2214B/VTO2214B Getr. / GBox: VT2514B/VTO2514B max. übertragbares Motormoment [Nm] / max. transmittable engine torque [Nm]: 2250	(87)
				3400 700 342 ⊕ ⊕ 3483 034 033 ⊕ 1878 000 634	430 24 MFZ430 430WGTZ	Getr. / GBox: SR1400/SR1700/SR1900	

NL 10 S							
Mot. TD 101, 102, 103	01.91 -	KFD117C		3400 106 031 ⊕ ⊕ 3483 034 032 ⊕ 1862 530 231	430 10 MFZ430 430WGTZ	Getr. / GBox: R/SR1400, 1700	
				3482 123 235	430 MFZ430	Getr. / GBox: R/SR1400, 1700 In 3483/3488 enthalten / Contained in 3483, 3488	(30)

NL 12 S							
Mot. TD 121, 122, 123	01.86 -	KFD214A		3400 031 033 ⊕ ⊕ 3483 014 132 ⊕ 1878 001 080 ⊕ 1878 001 082 ⊕ 3474 012 000	350 10 GMFZ2/350 350GTZ 350GTZ	Getr. / GBox: R/SR1400, 1700 ohne Zwischenring / without intermediate ring	(105)
				3488 013 138 ⊕	350 GMFZ2/350	Getr. / GBox: R/SR1400, 1700 enthält eine Kupplungsscheibe / This part number includes one clutch disc	(66)
				1878 001 082 ▽	350 10 350GTZ	Getr. / GBox: R/SR1400, 1700 Lose Kupplungsscheibe / Loose clutch disc	(39)
				3482 056 031	350 GMFZ2/350	Getr. / GBox: R/SR1400, 1700 In 3483/3488 enthalten / Contained in 3483, 3488	(30)
				3459 000 009	350 GMFZ2/350	Getr. / GBox: R/SR1400, 1700 In 3483/3488 enthalten / Contained in 3483, 3488	(30)

		CODE		 Parameter		
--	--	------	--	---	---	---

VOLVO

NL 12 S							
Mot. TD 121, 122, 123	01.91-	KFD215A		3400 030 033 #⊕ ⊕ 3483 017 031 ⊕ 1861 996 137 ⊕ 1861 997 137 ⊕ 3474 012 001	380 10 GMFZ2/380 380GVZ 380GVZ	Getr. / GBox: R/SR1400, 1700 ohne Zwischenring / without intermediate ring	(105)
				3482 059 031	380 GMFZ2/380	Getr. / GBox: R/SR1400, 1700 In 3483/3488 enthalten / Contained in 3483, 3488	(30)
				3459 010 101	380 GMFZ2/380	Getr. / GBox: R/SR1400, 1700	
				3400 700 427 ⊕ ⊕ 3488 019 032 ⊕ 1862 415 031	380 10 GMFZ2/380 380WGVZ	Getr. / GBox: R/SR1400, 1700	
				3400 700 326 ⊕ ⊕ 3483 027 332 ⊕ 1862 248 033 ⊕ 1862 415 031	380 10 GMFZ2/380 380GVZ 380WGVZ	Getr. / GBox: R/SR1400, 1700 ohne Zwischenring / without intermediate ring	(105)
				3482 111 032	380 GMFZ2/380	Getr. / GBox: R/SR1400, 1700 In 3483/3488 enthalten / Contained in 3483, 3488	(30)
				3459 017 031	380 GMFZ2/380	Getr. / GBox: R/SR1400, 1700 In 3488 enthalten / Contained in 3488	(31)





VOLVO PENTA

Benzinmotor							
230A				1866 032 231	287 26 287/ 133NTP	max. übertragbares Motormoment [Nm] / max. transmittable engine torque [Nm]: 425	(87)
230B							
250A							
250B							
251A							
AQ115A							
AQ115B							
AQ120B							
AQ125A							
AQ125B							
AQ130A							
AQ130B							
AQ130C							
AQ130D							
AQ131A							
AQ131B							
AQ131C							
AQ131D							
AQ140A							
AQ145A							
AQ145B							
AQ151A							
AQ151B							
AQ151C							
AQ171A							
AQ171C							
BB115A							
BB115B							
BB115C							
BB140A							
MB20A							
MB20B							
MB20C							

		CODE				
--	--	------	--	---	---	---



VOLVO PENTA

Benzinmotor							
AQ165A				1866 018 131	287 26 287/ 133NTP	max. übertragbares Motormoment [Nm] / max. transmittable engine torque [Nm]: 425	(87)
AQ170A							
AQ170B							
AQ170C							
AQD21A							
BB165A							
BB170A							
BB170B							
BB170C							





Dieselmotor							
AD31A				1866 032 231	287 26 287/ 133NTP	max. übertragbares Motormoment [Nm] / max. transmittable engine torque [Nm]: 425	(87)
AD31B							
AD31D							
AD31XD							
AQAD30A							
AQAD31A							
MD30A							
MD31A							
TAMD30A							
TAMD31A							
TAMD31B							
TAMD31D							
TMD30A							
TMD31A							
TMD31B							
TMD31D							
AD41A				1866 118 001	287 26 287/ 159NGS	max. übertragbares Motormoment [Nm] / max. transmittable engine torque [Nm]: 820	(87)
AD41B							
AD41D							
AQAD41A							
D41A							
D41B							
D41D							
KAD42A							
KAD42B							
TAMD41A							
TAMD41B							
TMD41A							
TMD41B							
AQAD40A				1866 018 131	287 26 287/ 133NTP	max. übertragbares Motormoment [Nm] / max. transmittable engine torque [Nm]: 425	(87)
AQAD40B							
MD40A				1866 032 231	287 26 287/ 133NTP	max. übertragbares Motormoment [Nm] / max. transmittable engine torque [Nm]: 425	(87)
TAMD40A							
TAMD40B							
TMD40A							
TMD40B							
TMD40C							
AQD21B				1866 018 131	287 26 287/ 133NTP	max. übertragbares Motormoment [Nm] / max. transmittable engine torque [Nm]: 425	(87)
AQD40A							
MD21B							
D3-190				1866 000 140	275 26 275/ 188NWGT P	max. übertragbares Motormoment [Nm] / max. transmittable engine torque [Nm]: 800	(87)

		CODE				
--	--	------	--	---	---	---



VOLVO PENTA

Dieselmotor							
D4-210A-A				1866 000 239	314 26 314/ 212NWGT P	max. übertragbares Motormoment [Nm] / max. transmittable engine torque [Nm]: 1500	(87)
D4-210A-B							
D4-225A-B							
D4-225A-C							
D4-260A-A							
D4-260A-B							
D4-260A-C							
D4-300A-A							
D4-300A-C							
D6-280A-A							
D6-280A-B							
D6-310A-A							
D6-310A-B							
D6-330A-B							
D6-350A-A							
D6-350A-B							
D6-370A-B							
DPH-A							
DPH-B							
DPR-A							
DPR-B							
DP-D				1866 118 001	287 26 287/ 159NGS	max. übertragbares Motormoment [Nm] / max. transmittable engine torque [Nm]: 820	(87)
DP-D1							
DP-D2							
DP-E				1866 032 231	287 26 287/ 133NTP	max. übertragbares Motormoment [Nm] / max. transmittable engine torque [Nm]: 425	(87)
DP-G							
DPX							



YaMZ

LKW							
LKW				3482 000 419	362 MF362	Getr. / GBox: ZF 6S-850	
				1878 002 071	362 10 362GTZ	Getr. / GBox: ZF 6S-850	
				3151 000 419	KZIS-4	Getr. / GBox: ZF 6S-850	
				3482 083 032	430 MFZ430	Getr. / GBox: ZF 6S-850	
				1878 085 641	430 10 430GTZ	Getr. / GBox: ZF 6S-850	

YAROVIT





Yarovit							
4443		DeutzBF6M101 5C		3482 083 032	430 MFZ430	Getr. / GBox: ZF 16 S 221	
				1878 080 037	430 10 430WGTZ	Getr. / GBox: ZF 16 S 221	
				3151 000 034	KZISZ-5	Getr. / GBox: ZF 16 S 221	





ZIL

LKW							
LKW				3482 083 032	430 MFZ430		
				3151 000 034	KZISZ-5		















		CODE		 Parameter		
---	--	------	--	---	---	---

BARKAS

B 1000 Bus (KO)		04.67 - 01.76		
1.0	04.67 - 12.91	H362-21	 3000 325 001 #  3082 967 001  1862 767 001  3159 900 001	180 24 MX180 180LB KT-0



















B 1000 Bus (KB)		01.76 -		
1.0	01.76 - 12.91	353-1/B1000	 3000 325 001 #  3082 967 001  1862 767 001  3159 900 001	180 24 MX180 180LB KT-0

BOVA



Futura		09.84 -			
FHD 10-340 FHD 12-340		DAFWS242M	 3482 119 031 430  1878 003 269 420 10  3151 182 233 KZI-5	GMF430 420GTZ	
FHD 12-370		WS268M	 3400 121 101 430 10  3482 119 031  1878 002 878  3151 182 233	GMF430 420GTZ KZI-5	Getr. / GBox: ZF S6-1600
FHD 14-430 XE Magnum FHD 15-430 XE Magnum		DAFXE315C1	 3482 083 032 430  1878 080 037 430 10  3151 000 157 KZISZ-5	MFZ430 430WGTZ	Getr. / GBox: ZF 8S-180 Getr. / GBox: ZF 8S-180
FHX 12-370		DAFWS268L, MAND2866LOH	 3482 083 032 430  3151 000 034 KZISZ-5	MFZ430 KZISZ-5	Getr. / GBox: ZF S8-180 Getr. / GBox: ZF S8-180
FLD 12-300		DAFRS222L	 3482 119 032 430  1878 027 231 400 10  3151 182 233 KZI-5	GMF430 400GTZ	

		CODE				
---	--	------	--	---	---	---



BOVA

Futura		09.84 -				
FUTURA	DAFDHS825		3400 124 701 ⊗ 3482 017 034 ⊗ 1878 000 105 ⊙ 3151 000 395	380 10 GMF380 380GTZ KZIS-4	->Chass. 3412	
	DAFDKT1160		3400 700 305 ⊗ 3482 118 031 ⊗ 1878 002 706 ⊙ 3151 000 515	430 10 GMF430 420GTZ KZIS-4	->Chass. 3597	
	DAFDKT, DKV, DKX1160		3482 119 032	430 GMF430	Chass. 3598->	
				1878 002 706	420 10 420GTZ	Chass. 3598->
				3151 000 395	KZIS-4	Chass. 3598->
	DBOM422		3482 124 534	430 GMF430		
				1882 301 239 ●	420 GF420	
				1878 002 706	420 10 420GTZ	
	DBOM422A		3482 124 522	430 GMF430		
				1878 002 706	420 10 420GTZ	
				3151 000 375	KZIS-4	
	DBOM442		3482 124 522	430 GMF430		
				1878 002 706	420 10 420GTZ	
	DBOM442A		3482 083 113	430 MFZ430		
				1878 080 037	430 10 430WGTZ	
				3151 217 001	KZIS-5	
	MAND2866LOH		3482 119 031	430 GMF430		
				1878 080 037	430 10 430WGTZ	
			3151 273 601	KZI-4,5		

DAF







Bus						
SB 4000		3482 083 032	430 MFZ430			
			1878 080 037	430 10 430WGTZ		
			3151 000 335	KZIS-5		

MB						
MB 200 DKTL MB 2000 DKTL		1878 001 138	420 10 420GTZ			
			3151 000 515	KZIS-4		
MB 230		3482 119 032	430 GMF430			
			1878 003 657	420 10 420WGTZ		
			3151 000 515	KZIS-4		

































SB		01.74 -				
SB 1600 DF SB 1600 DS SB 1600 DT		1882 110 542	350 GF350	Getr. / GBox: AK/S 5-35-2		
			1878 001 071	350 10 350GTZ	Getr. / GBox: AK/S 5-35-2	

		CODE				
---	--	------	--	---	---	---

DAF







SB		01.74 -	
SB 1602 DF SB 1602 DS			 1882 110 542 350 GF350  1878 001 071 350 10 350GTZ
SB 1602 DT SB 1605	DH/DU/DHB825		 1878 000 105 380 10 380GTZ
SB 3000	DKZ/DKX1160		 3482 119 032 430 GMF430  1878 003 657 420 10 420WGTZ  3151 000 515 KZIS-4

DRÖGMÖLLER

280 - 440			
E 280 E 290 E 300 E 310 E 320	OM422, A	 1800 125 301 420 10  1882 301 239 GF420  1878 002 706 420GTZ  3151 000 375 KZIS-4  3482 124 534 430 GMF430  1878 003 657 ● 420 10 420WGTZ  3151 000 375 KZIS-4	Getr. / GBox: ZF Getr. / GBox: ZF Getr. / GBox: ZF Getr. / GBox: ZF
E 330	OM422, A	 1800 125 301 420 10  1882 301 239 GF420  1878 002 706 420GTZ  3151 000 375 KZIS-4  3482 124 534 430 GMF430  1878 003 657 ● 420 10 420WGTZ  3151 000 375 KZIS-4	
	OM442A	 1888 055 041 380 GF2/380  1862 135 035 ▽ 380 10 380GS  1882 349 003 380 GF2/380  1859 250 100 380 GF2/380  1862 138 032 △ 380 10 380GSZ	enthält eine Kupplungsscheibe / This part number includes one clutch disc (66) Lose Kupplungsscheibe / Loose clutch disc (39) In 1888 enthalten / Contained in 1888 (29) In 1888 enthalten / Contained in 1888 (29) In 1888 enthalten / Contained in 1888 (29)
E 420 E 430 E 440	OM422, A	 1800 125 301 420 10  1882 301 239 GF420  1878 002 706 420GTZ  3151 000 375 KZIS-4  3482 124 534 430 GMF430  1878 003 657 ● 420 10 420WGTZ  3151 000 375 KZIS-4	
	OM442LA	 1888 042 009 380 GF2/380  1878 000 968 ▽ 380 10 380GTZ  3151 108 031 KZI-4,5  1882 341 001 380 GF2/380  1859 250 102 380 GF2/380  1878 000 968 △ 380 10 380GTZ	enthält eine Kupplungsscheibe / This part number includes one clutch disc (66) Lose Kupplungsscheibe / Loose clutch disc (39) In 1888 enthalten / Contained in 1888 (29) In 1888 enthalten / Contained in 1888 (29) In 1888 enthalten / Contained in 1888 (29)

		CODE					
---	--	------	--	--	---	---	---















ENASA

5036 - 6420							
5036		9156/12		3482 124 542	420		
				1878 003 276	420 10		
5117		9100/56		3482 124 542	420		
				1861 902 032 #	380 10		
5123		9220/2		3482 124 542	420		
				1878 003 276	420 10		

EVOBUS

Motor - Daimler							
Motor / Engine		OM457LA		6594 000 079	430	Getr. / GBox: 8 S 180; 10 AS 2301 Getr. / GBox: GO 190/210 für OE-Nummer / for OE number 457 030 13 05 enthält Schwungradbefestigungsschrauben / includes bolt for flywheel mounting	(83) (65)

NF 315...							
NF 315		OM447		3400 700 451 3482 081 231 1878 080 031 3151 000 157	430 10	MFZ430 430WGTZ KZISZ-5	

S 12 - S 15								
S 12		520GK		1881 041 656 #	380			
				3151 000 395	G380 KZIS-4			
S 12 L		520GK		1882 325 134	380			
				3151 000 395	G380 KZIS-4			
S 14		520GK		1881 041 656 #	380			
				3151 000 395	G380 KZIS-4			
			1881 041 656 #	380	Getr. / GBox: S 6-70-3			
		+6R1215EF-K, 6R1215F-K		3151 000 395	G380 KZIS-4	Getr. / GBox: S 6-70-3		
S 15		520GK		1881 041 656 #	380			
				3151 000 395	G380 KZIS-4			
		6R1215EF-K		1881 041 656 #	380	Getr. / GBox: S 6-70-3		
				3151 000 395	G380 KZIS-4	Getr. / GBox: S 6-70-3		
		GR1215GK		1882 325 134	380	Getr. / GBox: S 6-80		
				3151 000 395	G380 KZIS-4	Getr. / GBox: S 6-80		

















S 80...								
S 80		551-14K+552		1881 039 531 #	350	Getr. / GBox: S 8-45/2		
				3151 000 395	G350 KZIS-4	Getr. / GBox: S 5-35/2 Getr. / GBox: S 8-45/2		
		551-13K		1881 039 531 #	350	Getr. / GBox: S 8-45-2		
				3151 000 395	G350 KZIS-4	Getr. / GBox: S 8-45-2		
		DBOM352A		1882 252 333	310			
				1861 303 248	310 10	GFX310 310GSB		



		CODE					
---	--	------	--	--	---	---	---

EOBUS

S 100...							
S 100	01.78-	562-18K		1881 039 531 #	350 G350	Getr. / GBox: ZF S 6-60	
				3151 000 395	KZIS-4	Getr. / GBox: ZF S 6-60	
S 100		561-16K		1881 039 531 #	350 G350	Getr. / GBox: S 8-45/2	
				3151 000 395	KZIS-4	Getr. / GBox: S 8-45/2	

S 110...							
S 110	01.78-	562-18K		1881 039 531 #	350 G350	Getr. / GBox: ZF S 6-60	
				3151 000 395	KZIS-4	Getr. / GBox: ZF S 6-60	
S 110		561-16K		1881 039 531 #	350 G350	Getr. / GBox: S 8-35-2 Getr. / GBox: S 8-45/2	
				3151 000 395	KZIS-4	Getr. / GBox: S 8-35-2 Getr. / GBox: S 8-45/2	

















S 120...							
S 120	01.78-	562-18K		1881 039 531 #	350 G350	Getr. / GBox: ZF S 6-60	
				3151 000 395	KZIS-4	Getr. / GBox: ZF S 6-60	
S 120		561-16K		1881 039 531 #	350 G350	Getr. / GBox: S 8-45/2	
				3151 000 395	KZIS-4	Getr. / GBox: S 8-45/2	
		523-18K		1881 041 656 #	380 G380	Getr. / GBox: S 8-45/2	
				3151 000 395	KZIS-4	Getr. / GBox: S 8-45/2	
		524-20K		1881 041 656 #	380 G380	Getr. / GBox: S 8-45/2	
				3151 000 395	KZIS-4	Getr. / GBox: S 8-45/2	
	1882 325 134	380 G380	Getr. / GBox: S 6-80				
	3151 000 395	KZIS-4	Getr. / GBox: S 6-80				
S 125		520GK		1882 325 134	380 G380		
				3151 000 395	KZIS-4		
		6R1215EF-K		1881 041 656 #	380 G380	Getr. / GBox: S 4-60	
	3151 000 395	KZIS-4	Getr. / GBox: S 4-60				
S 128 DT 90				3482 083 113	430 MFZ430	Getr. / GBox: S 8-180	
				1878 080 037	430 10 430WGTZ	Getr. / GBox: S 8-180	
				3151 000 615	KZISZ-5	Getr. / GBox: S 8-180	

S 130...							
S 130	01.67-	523-20K		1881 041 656 #	380 G380	Getr. / GBox: S 6-70-3	
				3151 000 395	KZIS-4	Getr. / GBox: S 6-70-3	
		532-21K		1882 325 134	380 G380	Getr. / GBox: S 6-80	
				3151 000 395	KZIS-4	Getr. / GBox: S 6-80	
S 130	01.78-	562-18K		1881 039 531 #	350 G350	Getr. / GBox: ZF S 6-60	
				3151 000 395	KZIS-4	Getr. / GBox: ZF S 6-60	



















		CODE					
---	--	------	--	--	---	---	---

EVOBUS

S 130...















S 130		523-18K		1881 041 656 #	380 G380	Getr. / GBox: S 8-45/2	
				3151 000 395	KZIS-4	Getr. / GBox: S 8-45/2	
		524-20K		1881 041 656 #	380 G380	Getr. / GBox: S 8-45/2	
				3151 000 395	KZIS-4	Getr. / GBox: S 8-45/2	
				1882 325 134	380 G380	Getr. / GBox: S 6-80	
				3151 000 395	KZIS-4	Getr. / GBox: S 6-80	
		524-24K		1882 325 134	380 G380	Getr. / GBox: S 6-80 + GV 80	
				3151 000 395	KZIS-4	Getr. / GBox: S 6-80 + GV 80	
		561-16K		1881 039 531 #	350 G350	Getr. / GBox: S 8-45/2	
				3151 000 395	KZIS-4	Getr. / GBox: S 8-45/2	
		OM407H		3482 124 534	430 GMF430		
				1882 301 239 ●	420 GF420		
				1878 003 657	420 10 420WGTZ		
				3151 027 102	KZI4,5		
S 130 S		OM407H+MAN-D2566		1882 302 131	380 GF380	Getr. / GBox: S 6-80 + S 4-90	
				1878 001 152	380 10 380WGTZ	Getr. / GBox: S 6-80 + S 4-90	
				3151 027 102	KZI4,5	Getr. / GBox: S 6-80 + S 4-90	





















S 140...

S 140	01.78 -	562-18K		1881 039 531 #	350 G350	Getr. / GBox: ZF S 6-60	
				3151 000 395	KZIS-4	Getr. / GBox: ZF S 6-60	
S 140		524-20K		1881 041 656 #	380 G380	Getr. / GBox: S 8-45/2	
				3151 000 395	KZIS-4	Getr. / GBox: S 8-45/2	
				1882 325 134	380 G380	Getr. / GBox: S 6-80	
				3151 000 395	KZIS-4	Getr. / GBox: S 6-80	
		524-24K		1882 325 134	380 G380	Getr. / GBox: S 6-80 + GV 80	
				3151 000 395	KZIS-4	Getr. / GBox: S 6-80 + GV 80	
S 140 , ES		OM407H		3482 124 534	430 GMF430		
				1882 301 239 ●	420 GF420		
				1878 003 657	420 10 420WGTZ		
				3151 027 102	KZI4,5		
S 140 ES		D2566DHU		3482 124 534	430 GMF430	Getr. / GBox: S 6-80	
				1882 301 239 ●	420 GF420	Getr. / GBox: S 6-80	
				1878 003 657	420 10 420WGTZ	Getr. / GBox: S 6-80	
				3151 027 102	KZI4,5	Getr. / GBox: S 6-80	
		OM407H+MAN-D2566		1882 302 131	380 GF380	Getr. / GBox: S 6-80 + S 4-90	
				1878 001 152	380 10 380WGTZ	Getr. / GBox: S 6-80 + S 4-90	
				3151 027 102	KZI4,5	Getr. / GBox: S 6-80 + S 4-90	

		CODE					
---	--	------	--	--	---	---	---



































EVOBUS

S 150...							
S 150	01.67 -	523-20K		1881 041 656 #	380 G380	Getr. / GBox: S 6-70-3	
				3151 000 395	KZIS-4	Getr. / GBox: S 6-70-3	
S 150	01.78 -	562-18K		1881 039 531 #	350 G350	Getr. / GBox: ZF S 6-60	
				3151 000 395	KZIS-4	Getr. / GBox: ZF S 6-60	
S 150		523-18K		1881 041 656 #	380 G380	Getr. / GBox: S 8-45/2	
				3151 000 395	KZIS-4	Getr. / GBox: S 8-45/2	
		524-20K		1881 041 656 #	380 G380	Getr. / GBox: S 8-45/2	
				1882 325 134	380 G380	Getr. / GBox: S 6-80	
				3151 000 395	KZIS-4	Getr. / GBox: S 6-80 Getr. / GBox: S 8-45/2	
		524-24K		1882 325 134	380 G380	Getr. / GBox: S 6-80 + GV 80	
				3151 000 395	KZIS-4	Getr. / GBox: S 6-80 + GV 80	
		532-21K		1882 325 134	380 G380	Getr. / GBox: S 6-80	
				3151 000 395	KZIS-4	Getr. / GBox: S 6-80	
		561-16K		1881 039 531 #	350 G350	Getr. / GBox: S 8-45/2	
	3151 000 395		KZIS-4	Getr. / GBox: S 8-45/2			

S 200...							
S 200		OM442A		1882 342 134	420 GF420X		
				1878 005 486	420 10 420WGTZ		
				3151 027 133	KZI4,5		
S 200 Fahrzeug / Vehicle -20		OM403		3482 124 534	430 GMF430		
				1882 301 239 ●	420 GF420		
				1861 410 047 #	420 10 420/ 210GSZ		
				3151 000 515	KZIS-4		
S 200 Fahrzeug / Vehicle 21-		OM403		3482 124 534	430 GMF430		
				1882 301 239 ●	420 GF420		
				1878 002 706	420 10 420GTZ		
				3151 027 102	KZI4,5		
S 208		OM352A		3482 012 211	330 GMF330	Getr. / GBox: S 6-65	
				1861 571 110 #	330 10 330GSZ	Getr. / GBox: S 6-65	
				3151 099 101	KZI-4	Getr. / GBox: S 6-65	
S 208 H		OM352A		3482 012 211	330 GMF330	Getr. / GBox: S 6-36	
				1861 874 032	330 10 330WGSZ	Getr. / GBox: S 6-36	
				3151 099 101	KZI-4	Getr. / GBox: S 6-36	
S 209 , H		OM401		1882 302 131	380 GF380	Getr. / GBox: S 6-65	
				1878 001 152	380 10 380WGTZ	Getr. / GBox: S 6-65	
				3151 027 102	KZI4,5	Getr. / GBox: S 6-65	



































		CODE		 Parameter		
---	--	------	--	---	---	---

EVOBUS

S 210...							
S 210 H	OM421A	 3482 012 211	330 GMF330	Getr. / GBox: S 6-65			
		 1861 571 110 #	330 10 330GSZ	Getr. / GBox: S 6-65			
		 3151 099 101	KZI-4	Getr. / GBox: S 6-65			
S 210 H/HD	OM421A	 3482 124 534	430 GMF430	Getr. / GBox: S 6-90			
		 1882 301 239 ●	420 GF420	Getr. / GBox: S 6-90			
		 1878 003 657	420 10 420WGTZ	Getr. / GBox: S 6-90			
		 3151 027 102	KZI4,5	Getr. / GBox: S 6-90			
S 211 , H S 214	OM401	 1882 302 131	380 GF380	Getr. / GBox: S 6-65			
		 1878 001 152	380 10 380WGTZ	Getr. / GBox: S 6-65			
		 3151 027 102	KZI4,5	Getr. / GBox: S 6-65			
S 211 H	OM421	 1882 302 131	380 GF380	Getr. / GBox: S 6-65			
		 1878 001 152	380 10 380WGTZ	Getr. / GBox: S 6-65			
S 211 H/HD S 213 H/HD, RL	OM422	 3482 124 534	430 GMF430	Getr. / GBox: S 6-90			
		 1882 301 239 ●	420 GF420	Getr. / GBox: S 6-90			
		 1878 003 657	420 10 420WGTZ	Getr. / GBox: S 6-90			
		 3151 027 102	KZI4,5	Getr. / GBox: S 6-90			
S 212	OM401	 1882 302 131	380 GF380	Getr. / GBox: S 6-65			
		 1878 001 152	380 10 380WGTZ	Getr. / GBox: S 6-65			
		 3151 027 102	KZI4,5	Getr. / GBox: S 6-65			
	OM402	 1882 302 131	380 GF380	Getr. / GBox: S 6-80			
		 1878 001 152	380 10 380WGTZ	Getr. / GBox: S 6-80			
		 3151 027 102	KZI4,5	Getr. / GBox: S 6-80			
	OM403	 3482 124 534	430 GMF430	Getr. / GBox: S 6-90			
		 1882 301 239 ●	420 GF420	Getr. / GBox: S 6-90			
		 1878 003 657	420 10 420WGTZ	Getr. / GBox: S 6-90			
		 3151 027 102	KZI4,5	Getr. / GBox: S 6-90			
	S 213 S 215	OM401	 1882 302 131	380 GF380	Getr. / GBox: S 6-65		
			 1878 001 152	380 10 380WGTZ	Getr. / GBox: S 6-65		
 3151 027 102			KZI4,5	Getr. / GBox: S 6-65			
OM402		 1882 302 131	380 GF380	Getr. / GBox: S 6-80			
		 1878 001 152	380 10 380WGTZ	Getr. / GBox: S 6-80			
		 3151 027 102	KZI4,5	Getr. / GBox: S 6-80			
S 213 H/HD S 215 H/HD	OM422A	 1882 342 134	420 GF420X	Getr. / GBox: S 4-120GP, S 6-150C			
		 1878 003 657	420 10 420WGTZ	Getr. / GBox: S 4-120GP, S 6-150C			
		 3151 027 102	KZI4,5	Getr. / GBox: S 4-120GP, S 6-150C			

































		CODE					
---	--	------	--	--	---	---	---

EOBUS

S 210...							
S 213 HD, HR		OM403	 3482 124 534	430 GMF430	Getr. / GBox: S 6-90		
			 1882 301 239 ●	420 GF420	Getr. / GBox: S 6-90		
			 1878 003 657	420 10 420WGTZ	Getr. / GBox: S 6-90		
			 3151 027 102	KZI4,5	Getr. / GBox: S 6-90		
S 214 HD	MAND2866KOH	 1882 342 134	420 GF420X	Getr. / GBox: S 6-150C			
		 1861 911 232	420 10 420WGVZ	Getr. / GBox: S 6-150C			
		 3151 027 102	KZI4,5	Getr. / GBox: S 6-150C			
	OM422A	 1882 342 134	420 GF420X	Getr. / GBox: S 4-120GP, S 6-150C			
		 1878 003 657	420 10 420WGTZ	Getr. / GBox: S 4-120GP, S 6-150C			
		 3151 027 102	KZI4,5	Getr. / GBox: S 4-120GP, S 6-150C			
S 215 , UL		OM422, 447	 3482 124 534	430 GMF430	Getr. / GBox: S 6-90,S 6-150C		
			 1882 301 239 ●	420 GF420	Getr. / GBox: S 6-90,S 6-150C		
			 1878 003 657	420 10 420WGTZ	Getr. / GBox: S 6-90,S 6-150C		
			 3151 027 102	KZI4,5	Getr. / GBox: S 6-90,S 6-150C		
S 215 H/HD, RL		OM422, 442	 3482 124 534	430 GMF430	Getr. / GBox: S 6-90		
			 1882 301 239 ●	420 GF420	Getr. / GBox: S 6-90		
			 1878 003 657	420 10 420WGTZ	Getr. / GBox: S 6-90		
			 3151 027 102	KZI4,5	Getr. / GBox: S 6-90		
S 215 HD	MAND2866KOH	 1882 342 134	420 GF420X	Getr. / GBox: S 6-150C			
		 1861 911 232	420 10 420WGVZ	Getr. / GBox: S 6-150C			
		 3151 027 102	KZI4,5	Getr. / GBox: S 6-150C			
	MAND2866LOH	 1882 342 134	420 GF420X	Getr. / GBox: S 6-150C			
		 1878 003 657	420 10 420WGTZ	Getr. / GBox: S 6-150C			
		 3151 027 102	KZI4,5	Getr. / GBox: S 6-150C			
	OM442A	 1882 342 134	420 GF420X	Getr. / GBox: S 8-180			
		 1878 005 486	420 10 420WGTZ	Getr. / GBox: S 8-180			
		 3151 027 133	KZI4,5	Getr. / GBox: S 8-180			
S 215 HD, HR	OM401	 3482 081 233	430 MFZ430	Getr. / GBox: S 6-85			
		 1878 080 031	430 10 430WGTZ	Getr. / GBox: S 6-85			
		 3151 000 278	KZISZ-5	Getr. / GBox: S 6-85			
	OM403	 3482 124 534	430 GMF430	Getr. / GBox: S 6-90			
		 1882 301 239 ●	420 GF420	Getr. / GBox: S 6-90			
		 1878 003 657	420 10 420WGTZ	Getr. / GBox: S 6-90			
		 3151 027 102	KZI4,5	Getr. / GBox: S 6-90			

		CODE					
---	--	------	--	--	---	---	---





EVOBUS















S 210...								
S 215 HR		OM441LA		3482 083 032	430 MFZ430	Getr. / GBox: S 8-180		
				1878 080 033	430 10 430WGTZ	Getr. / GBox: S 8-180		
				3151 000 615	KZISZ-5	Getr. / GBox: S 8-180		
S 215 RL		OM401LA		3482 081 233	430 MFZ430	Getr. / GBox: S 6-85		
				1878 080 031	430 10 430WGTZ	Getr. / GBox: S 6-85		
				3151 000 278	KZISZ-5	Getr. / GBox: S 6-85		
S 215 UL	D2865LOH			3482 124 549	430 GMF430	Getr. / GBox: S 6-85		
				1882 342 135 ● #	420 GF420X	Getr. / GBox: S 6-85		
				1878 065 131 #	420 10 420WGTZ	Getr. / GBox: S 6-85		
				3151 027 133	KZI4,5	Getr. / GBox: S 6-85		
	OM447				3482 124 534	430 GMF430	Getr. / GBox: S 6-85	
					1882 301 239 ●	420 GF420	Getr. / GBox: S 6-85	
					1878 003 657	420 10 420WGTZ	Getr. / GBox: S 6-85	
					3151 027 133	KZI4,5	Getr. / GBox: S 6-85	
S 215 UL/SL		OM407H, HA/427H, HA		3482 124 534	430 GMF430	Getr. / GBox: S 4-90, S 5-80 Getr. / GBox: S 6-80, S 6-150 C		
				1882 301 239 ●	420 GF420	Getr. / GBox: S 4-90, S 5-80 Getr. / GBox: S 6-80, S 6-150 C		
				1878 003 657	420 10 420WGTZ	Getr. / GBox: S 4-90, S 5-80 Getr. / GBox: S 6-80, S 6-150 C		
				3151 027 102	KZI4,5	Getr. / GBox: S 4-90, S 5-80 Getr. / GBox: S 6-80, S 6-150 C		
S 216 HDS	MAND2866KOH			1882 342 134	420 GF420X	Getr. / GBox: S 6-150C		
				1861 911 232	420 10 420WGVZ	Getr. / GBox: S 6-150C		
				3151 027 102	KZI4,5	Getr. / GBox: S 6-150C		
	OM422A				1882 342 134	420 GF420X	Getr. / GBox: S 4-120GP, S 6-150C	
					1878 003 657	420 10 420WGTZ	Getr. / GBox: S 4-120GP, S 6-150C	
					3151 027 102	KZI4,5	Getr. / GBox: S 4-120GP, S 6-150C	
					1882 342 134	420 GF420X	Getr. / GBox: S 8-180	
					1878 005 486	420 10 420WGTZ	Getr. / GBox: S 8-180	
					3151 027 133	KZI4,5	Getr. / GBox: S 8-180	
					1888 042 009	380 GF2/380	Getr. / GBox: S 4-150GP, S 6-150C enthält eine Kupplungsscheibe / This part number includes one clutch disc (66)	
		1878 000 968 ▽	380 10 380GTZ	Getr. / GBox: S 4-150GP, S 6-150C Lose Kupplungsscheibe / Loose clutch disc (39)				
		3151 108 031	KZI-4,5	Getr. / GBox: S 8-180				
		1882 341 001	380 GF2/380	Getr. / GBox: S 4-150GP, S 6-150C In 1888 enthalten / Contained in 1888 (29)				
		1859 250 102	380 GF2/380	Getr. / GBox: S 4-150GP, S 6-150C In 1888 enthalten / Contained in 1888 (29)				
	1878 000 968 △	380 10 380GTZ	Getr. / GBox: S 4-150GP, S 6-150C In 1888 enthalten / Contained in 1888 (29)					

		CODE					
---	--	------	--	--	---	---	---



EVOBUS

S 220...











S 221 UL		OM447		3482 124 534	430 GMF430		
				1882 301 239 ●	420 GF420		
				1878 003 657	420 10 420WGTZ		
				3151 027 102	KZI4,5		

S 228 DT		OM422LA		1888 042 009	380 GF2/380	Getr. / GBox: S 4-150GP, S 6-150C enthält eine Kupplungsscheibe / This part number includes one clutch disc	(66)
				1878 000 968 ▽	380 10 380GTZ	Getr. / GBox: S 4-150GP, S 6-150C Lose Kupplungsscheibe / Loose clutch disc	(39)
				3151 108 031	KZI-4,5	Getr. / GBox: S 4-150GP, S 6-150C	
				1882 341 001	380 GF2/380	Getr. / GBox: S 4-150GP, S 6-150C In 1888 enthalten / Contained in 1888	(29)
				1859 250 102	380 GF2/380	Getr. / GBox: S 4-150GP, S 6-150C In 1888 enthalten / Contained in 1888	(29)
				1878 000 968 △	380 10 380GTZ	Getr. / GBox: S 4-150GP, S 6-150C In 1888 enthalten / Contained in 1888	(29)
		OM442LA		3482 081 233	430 MFZ430	Getr. / GBox: S 8-180	
				1878 080 037	430 10 430WGTZ	Getr. / GBox: S 8-180	
				3151 000 157	KZISZ-5	Getr. / GBox: S 8-180	
				3488 017 410	400 MFZ2/400X	Getr. / GBox: S 8-180 enthält eine Kupplungsscheibe / This part number includes one clutch disc	(66)
				1878 634 022 ▽#	400 10 400GVZ	Getr. / GBox: S 8-180	
				1878 005 805 ▽	400 10 400GTZ	Getr. / GBox: S 8-180	
				3151 000 157	KZISZ-5	Getr. / GBox: S 8-180	
				1878 634 023 △#	400 10 400GVZ	Getr. / GBox: S 8-180	
				1878 005 805 △	400 10 400GTZ	Getr. / GBox: S 8-180	

S 300...































S 309		OM441LA		3482 081 232	430 MFZ430		
				1878 085 742	430 10 430WGTZ		
				3151 000 615	KZISZ-5		

S 310...

S 312 HD, HDH		OM401LA, 422		3482 081 232	430 MFZ430		
				1878 085 742	430 10 430WGTZ		
				3151 000 615	KZISZ-5		
		OM402LA, 442A, LA		3482 083 032	430 MFZ430		
				1878 002 734	430 10 430WGTZ		
				3151 000 615	KZISZ-5		
				3400 700 498 ● ● 3482 083 032 ● 1878 080 034	430 10 MFZ430 430WGTZ	Bei Geräuschproblemen / In case of noise problems	(13)
		OM441LA		3482 083 113	430 MFZ430		
				1878 002 734	430 10 430WGTZ		
				1878 080 034	430 10 430WGTZ	Bei Geräuschproblemen / In case of noise problems	(13)
				3151 000 615	KZISZ-5		



















		CODE					
---	--	------	--	--	---	---	---







EVOBUS

S 310...								
S 315		OM447		3482 124 534	430 GMF430			
				1878 003 657	420 10 420WGTZ			
				3151 027 102	KZI4,5			
S 315 GT		OM442LA		3400 127 801 ⊗ 3482 081 233 ⊗ 1878 002 734 ⊙ 3151 000 157	430 10 MFZ430 430WGTZ KZISZ-5			
				3400 700 349 ⊗ 3482 081 233 ⊗ 1878 080 034 ⊙ 3151 000 157	430 10 MFZ430 430WGTZ KZISZ-5	Bei Geräuschproblemen / In case of noise problems	(13)	
S 315 GT-HD	D2866LUH, OM441LA, OM447hLA			3482 081 233	430 MFZ430	Getr. / GBox: ZF S6-85		
				1878 080 031	430 10 430WGTZ	Getr. / GBox: ZF S6-85		
				3151 000 157	KZISZ-5	Getr. / GBox: ZF S6-85		
				3482 081 233	430 MFZ430	Getr. / GBox: ZF S6-150 Getr. / GBox: ZF S8-180 Getr. / GBox: ZF S6-1600		
				1878 080 037	430 10 430WGTZ	Getr. / GBox: ZF S6-150 Getr. / GBox: ZF S8-180 Getr. / GBox: ZF S6-1600		
				3151 000 157	KZISZ-5	Getr. / GBox: ZF S6-150 Getr. / GBox: ZF S8-180 Getr. / GBox: ZF S6-1600		
		OM441, 442LA, 447hLA			3482 081 233	430 MFZ430	Getr. / GBox: GO 4	
					1878 080 037	430 10 430WGTZ	Getr. / GBox: GO 4	
					3151 000 547	KZISZ-5	Getr. / GBox: GO 4	
	OM442LA			3482 081 233	430 MFZ430	Getr. / GBox: GO 4 mit Retarder VR 115E / with retarder VR 115E	(90)	
				1878 080 037	430 10 430WGTZ	Getr. / GBox: GO 4 mit Retarder VR 115E / with retarder VR 115E	(90)	
				3151 000 547	KZISZ-5	Getr. / GBox: GO 4 mit Retarder VR 115E / with retarder VR 115E	(90)	
	S 315 HD, HDH	OM401LA, 422			3482 081 232	430 MFZ430		
					1878 085 742	430 10 430WGTZ		
					3151 000 615	KZISZ-5		
OM402LA, 442A				3482 083 032	430 MFZ430			
				1878 002 734	430 10 430WGTZ			
				3151 000 615	KZISZ-5			
OM441LA				3400 700 498 ⊙ ⊗ 3482 083 032 ⊗ 1878 080 034	430 10 MFZ430 430WGTZ	Bei Geräuschproblemen / In case of noise problems	(13)	
				3482 083 113	430 MFZ430			
				1878 002 734	430 10 430WGTZ			
				1878 080 034	430 10 430WGTZ	Bei Geräuschproblemen / In case of noise problems	(13)	
OM442LA				3151 000 615	KZISZ-5			
				3482 081 233	430 MFZ430			
				1878 080 037	430 10 430WGTZ			
S 315 NF S 317 ÜL S 319 UL			OM457hLA		3400 700 509 ■	430 10	XTend Nabenprofil / Hub Profile: 41,1x50,8-10N Nur zusammen verbauen / Only install together	(46) (51)







		CODE					
---	--	------	--	--	---	---	---

EVOBUS

S 310...							
S 315 UL		OM441, 447HLA		3400 700 451  3482 081 231  1878 080 031  3151 000 157	430 10 MFZ430 430WGTZ KZISZ-5		
			MAND2866LUH		3482 081 233	430 MFZ430	
				1878 080 033	430 10 430WGTZ		
			3151 000 157	KZISZ-5			
S 316 HDS S 317 HDH		OM442LA		3482 083 032	430 MFZ430		
				1878 002 734	430 10 430WGTZ		
				3151 000 615	KZISZ-5		
			3400 700 498   3482 083 032  1878 080 034	430 10 MFZ430 430WGTZ	Bei Geräuschproblemen / In case of noise problems (13)		
S 319 NF		447hLA, D2866LUH, OM441LA		3482 081 233	430 MFZ430		
				1878 080 033	430 10 430WGTZ	Getr. / GBox: S6-1600/S6-150 Getr. / GBox: S8-180	
				1878 080 031	430 10 430WGTZ	Getr. / GBox: ZF 6S-85	
				3151 000 157	KZISZ-5		

S 320...							
S 328 DT		OM442LA		3488 017 410	400 MFZ2/400X	Getr. / GBox: S 8-180 enthält eine Kupplungsscheibe / This part number includes one clutch disc (66)	
				1878 634 022 ▽#	400 10 400GVZ	Getr. / GBox: S 8-180	
				1878 005 805 ▽	400 10 400GTZ	Getr. / GBox: S 8-180	
				3151 000 157	KZISZ-5	Getr. / GBox: S 8-180	
				1878 005 805 △	400 10 400GTZ	Getr. / GBox: S 8-180	
				1878 634 023 △#	400 10 400GVZ	Getr. / GBox: S 8-180	



























SG 175...							
SG 175		520GK		1882 325 134	380 G380		
				3151 000 395	KZIS-4		

SG 180...							
SG 180		MAND2566DHU		3482 124 534	430 GMF430	Getr. / GBox: S 6-80	
				1882 301 239 ●	420 GF420	Getr. / GBox: S 6-80	
		MAND2566DHU , OM407H		1878 003 657	420 10 420WGTZ	Getr. / GBox: S 6-80	
				3151 027 102	KZI4,5	Getr. / GBox: S 6-80	
			OM407H+MAN- D2566		1882 302 131	380 GF380	Getr. / GBox: S 6-80 + S 4-90
				1878 001 152	380 10 380WGTZ	Getr. / GBox: S 6-80 + S 4-90	
				3151 027 102	KZI4,5	Getr. / GBox: S 6-80 + S 4-90	



		CODE					
---	--	------	--	--	---	---	---

IKARUS

100 - 542

255 250	D2156HM6U	 3482 124 541	430 GMF430	Getr. / GBox: 5-G	
		 1882 330 032 ●#	420 GF420	Getr. / GBox: 5-G	
		 1861 206 211 #	420 10 420GS	Getr. / GBox: 5-G	
		 3482 124 531	430 GMF430	Getr. / GBox: 6-G	
		 1882 316 035 ●#	420 GF420	Getr. / GBox: 6-G	
		 1878 001 138	420 10 420GTZ	Getr. / GBox: 6-G	
		 3151 000 515	KZIS-4	Getr. / GBox: 6-G	
		 1863 009 100	GR-5	Getr. / GBox: 5-G mit Anlauftring / with thrust ring	(88)
280 256		 3482 124 541	430 GMF430	Getr. / GBox: 5-G	
		 1882 330 032 ●#	420 GF420	Getr. / GBox: 5-G	
		 1861 206 211 #	420 10 420GS	Getr. / GBox: 5-G	
		 3482 124 531	430 GMF430	Getr. / GBox: 6-G	
		 1882 316 035 ●#	420 GF420	Getr. / GBox: 6-G	
		 1878 001 138	420 10 420GTZ	Getr. / GBox: 6-G	
		 3151 000 515	KZIS-4	Getr. / GBox: 6-G	
		 1863 009 100	GR-5	Getr. / GBox: 5-G mit Anlauftring / with thrust ring	(88)
266		 3482 124 541	430 GMF430	Getr. / GBox: 5-G	
		 1882 330 032 ●#	420 GF420	Getr. / GBox: 5-G	
		 1861 206 211 #	420 10 420GS	Getr. / GBox: 5-G	
		 1882 316 035 #	420 GF420	Getr. / GBox: 6-G	
		 1878 001 138	420 10 420GTZ	Getr. / GBox: 6-G	
		 3151 000 515	KZIS-4	Getr. / GBox: 6-G	
		 1863 009 100	GR-5	Getr. / GBox: 5-G mit Anlauftring / with thrust ring	(88)
		521 (VW)		 3000 055 005	228 23 M228 220VTPB KZIS-0
542	OM364	 3482 055 132	310 MFZ310		
		 1861 303 248	310 10 310GSB		
		 3151 170 131	KZIZ-3		























IK 212

IK 212		 1881 039 532 #	350 G350KR		
		 1878 005 367	350 10 350WGTZ		





		CODE				
---	--	------	--	---	---	---

IRISBUS

ARES 10.03 -

Ares				3482 083 252	430 MFZ430	Getr. / GBox: B8 TBV			
				1878 020 241	430 20 430WGTZ	Getr. / GBox: B8 TBV			
				3151 250 231	KZISZ-5	Getr. / GBox: B8 TBV			
				3482 083 252	430 MFZ430	Getr. / GBox: ZF 6S-85 Getr. / GBox: ZF 8S-180			
				3400 700 493  3482 083 252  1878 004 832	430 10 MFZ430 430WGTZ	-> 10.2001 Getr. / GBox: ZF 8S-180 bis Produktionsnummer / to production Number: CAM 15K1	(63)		
				1878 026 241	430 10 430WGTZ	Getr. / GBox: ZF 6S-85			
				3151 250 231	KZISZ-5	Getr. / GBox: ZF 6S-85 Getr. / GBox: ZF 8S-180			
				3482 083 252	430 MFZ430	Getr. / GBox: ZF 10AS2301			
				3400 700 493  3482 083 252  1878 004 832	430 10 MFZ430 430WGTZ	-> 10.2001 Getr. / GBox: ZF 10AS2301 bis Produktionsnummer / to production Number: CAM 15K1	(63)		
				3151 000 144	KZISZ-5	Getr. / GBox: ZF 10AS2301			
			DCI11, MIDR062356			3482 083 252	430 MFZ430	Getr. / GBox: ZF 6S-1600	
						3400 700 493  3482 083 252  1878 004 832	430 10 MFZ430 430WGTZ	-> 10.2001 Getr. / GBox: ZF 6S-1600 bis Produktionsnummer / to production Number: CAM 15K1	(63)
						3151 250 231	KZISZ-5	Getr. / GBox: ZF 6S-1600	
			F2B			3482 078 134	400 MFZ400	Getr. / GBox: 6S-1600	
						1878 032 032	400 10 400WGTZ	Getr. / GBox: 6S-1600	
	3151 000 157	KZISZ-5			Getr. / GBox: 6S-1600				



AXER 10.03 - 01.07

C956				3400 700 328  3482 078 134  1878 032 032  3151 000 157	400 10 MFZ400 400WGTZ KZISZ-5		
------	--	--	---	--	---	--	--

CROSSWAY 06.06 -

10.6m, 12m, 12.8m 10.6m, 12m, 12.8m 12m, 12.8m 10.6m, 12m, 12.8m	06.06 -	F2BE0682		3400 700 497  3482 078 132  1878 634 034  3151 250 231	400 10 MFZ400 395WGTZ KZISZ-5	Getr. / GBox: 6S 1600	
		F4AE0682, F4AE0682L, F4AE3882A		3400 700 497  3482 078 132  1878 634 034  3151 250 231	400 10 MFZ400 395WGTZ KZISZ-5	Getr. / GBox: 6S 1200	















DOMINO 10.03 -

HD HD, HDH	06.06 - 06.06 -			3482 000 573	430 MFZ430	Getr. / GBox: AS-Tronic	
				1878 000 298	430 10 430GTZ/E	Getr. / GBox: AS-Tronic	
				3151 000 493	KZISZ-5	Getr. / GBox: AS-Tronic für Ausrückgabel mit Rollen / for release fork with rollers	(70)





		CODE					
---	--	------	--	--	---	---	---

IRISBUS









ILIADÉ 10.03 -

Iliade			 3400 123 401  3482 083 252  1878 020 241  3151 250 231	430 20 MFZ430 430WGTZ KZISZ-5	06.1997-> Getr. / GBox: B9,B8 170R5 TBV	
			 3400 700 409  3482 083 252  1878 026 241  3151 250 231	430 10 MFZ430 430WGTZ KZISZ-5	09.1997-> Getr. / GBox: ZF S6-85	
			 3400 700 330  3482 083 252  1878 004 832  3151 250 231	430 10 MFZ430 430WGTZ KZISZ-5	10.1997-> Getr. / GBox: ZF S8-180 ab Produktionsnummer / from Production Number: CAM 12KV	(60)
			 3482 083 252	430 MFZ430	Getr. / GBox: ZF 6S-1600	
			 3151 250 231	KZISZ-5	Getr. / GBox: ZF 6S-1600	





KAROSA 01.99 -

MIHR 062045			 3482 083 044	430 MFZ430		
			 1878 026 241	430 10 430WGTZ		
			 3100 008 106  3151 234 132  3180 000 009	KZISZ-5 KZISZ-5	Beinhaltet Ausrücker und Montagesatz / Contains releaser and fitting kit	(14)

MAGELYS 08.08 -

Magelys	01.07 -	Cursor9	 6594 000 211	430Z	Getr. / GBox: 12 AS 2001 Getr. / GBox: 6 S 1911 Abgasnorm: Euro 6 / Exhaust Emission Norm: Euro 6	(4)
			 3482 083 040	430 MFZ430	Getr. / GBox: 12 AS 2001 Getr. / GBox: 6 S 1911 Abgasnorm: Euro 6 / Exhaust Emission Norm: Euro 6	(4)
			 1878 054 933	430 10 430GTZ	Getr. / GBox: 12 AS 2001 Getr. / GBox: 6 S 1911 Abgasnorm: Euro 6 / Exhaust Emission Norm: Euro 6	(4)
			 3151 001 084	KZISZ-5	Getr. / GBox: 6 S 1911 Abgasnorm: Euro 6 / Exhaust Emission Norm: Euro 6	(4)
			3151 000 493	KZISZ-5	Getr. / GBox: 12 AS 2001 Abgasnorm: Euro 6 / Exhaust Emission Norm: Euro 6 für Ausrückgabel mit Rollen / for release fork with rollers	(4) (70)
HD HD	08.08 - 08.08 -		 6594 000 171	430 430Z	für Motoren mit Zweimassenschwungrad / for engines with dual-mass flywheel	(80)
			 3482 000 573	430 MFZ430	Getr. / GBox: AS-Tronic	
			 1878 000 298	430 10 430GTZ/E	Getr. / GBox: AS-Tronic	
			 3151 000 493	KZISZ-5	Getr. / GBox: AS-Tronic für Ausrückgabel mit Rollen / for release fork with rollers	(70)

MIDIRIDER





Bus		F2BE0682	 3400 700 497  3482 078 132  1878 634 034  3151 250 231	400 10 MFZ400 395WGTZ KZISZ-5	Getr. / GBox: 6S 1600	
		F4AE0682, F4AE0682L, F4AE3882A	 3400 700 497  3482 078 132  1878 634 034  3151 250 231	400 10 MFZ400 395WGTZ KZISZ-5	Getr. / GBox: 6S 1200	

OBRADORE 01.99 -

Obradore		MIDR062045M1 , MIDR062045M4 1, MIDR062056A4 1	 3400 123 401  3482 083 252  1878 020 241  3151 250 231	430 20 MFZ430 430WGTZ KZISZ-5	Getr. / GBox: B9/B8L	
			 3482 083 252	430 MFZ430	Getr. / GBox: ZF S8-180	
			 1878 022 841	430 10 430GTZ	Getr. / GBox: ZF S8-180	
			 3151 250 231	KZISZ-5	Getr. / GBox: ZF S8-180	



		CODE				
---	--	------	--	---	---	---



IRISBUS









RECREO		10.03 - 01.07				
C 935		MIHR062045A/4 1	 3400 116 901 ⊗ 3482 083 044 ⊗ 1878 026 241 ⊙ 3100 008 106	430 10 MFZ430 430WGTZ KZISZ-5	Getr. / GBox: 5P 115	
C 955			 3400 700 328 ⊗ 3482 078 134 ⊗ 1878 032 032 ⊙ 3151 000 157	400 10 MFZ400 400WGTZ KZISZ-5		
12m, 12.8m	10.03-01.07	F2BE0682	 3400 700 497 ⊗ 3482 078 132 ⊗ 1878 634 034 ⊙ 3151 250 231	400 10 MFZ400 395WGTZ KZISZ-5	Getr. / GBox: 6S 1600	
		F4AE0682, F4AE0682L, F4AE3882A	 3400 700 497 ⊗ 3482 078 132 ⊗ 1878 634 034 ⊙ 3151 250 231	400 10 MFZ400 395WGTZ KZISZ-5	Getr. / GBox: 6S 1200	

TRACER		01.99 -				
332		MIHR062045	 3400 700 341 # ⊗ 3482 083 044 ⊗ 1878 049 041 ⊙ 3100 008 106	430 16 MFZ430 430WGTZ KZISZ-5	Getr. / GBox: G406	

IVECO











A 55... - A 90...						
A 55-10			 1882 806 001 ▲	280 H280	09.1983->	
			 1878 600 841	280 10 280CTB	->08.1983	
			1878 600 841	280 10 280CTB	09.1983->	



Bus						
Midirider 27			 3482 123 839	395 MF395	YAHE00A1 / YAHE00AD	
			 1878 000 036	395 10 395WGTZ	YAHE00A1 / YAHE00AD	
			 3151 000 419	KZIS-4	YAHE00A1 / YAHE00AD	

DAILY II Bus		01.89 - 05.99				
A 40-10 (94139111, 94139131, 94139311, 94139315...)	01.91 - 12.96	8140.27S	 3000 951 026 ⊗ 3083 039 031 ⊗ 1878 002 072 ⊙ 3151 600 529	235 10 MFZ235X 235VTB KZISZ-2	Getriebenummer / Transmission Number: 2826.5 94139131 / 94139331 / 94139335 / 94139337	(26)
			 3400 700 429 ⊗ 3482 907 001 ⊗ 1862 967 001 ⊙ 3151 065 031	265 10 MF265 265TB KZI-1	->Chass. 5928512 Getriebenummer / Transmission Number: 2826.5 94139111 / 94139311 / 94139315 / 94139317	(26)
			 3000 951 026 ⊗ 3083 039 031 ⊗ 1878 002 072 ⊙ 3151 600 529	235 10 MFZ235X 235VTB KZISZ-2	Chass. 5928513-> Getriebenummer / Transmission Number: 2826.5 94139111 / 94139311 / 94139315 / 94139317	(26)
A 40-10 (95719111, 95719131, 95719311, 95719315...)	09.96 - 05.99	8140.23	 3400 700 432 ■	280 10 280/Z	Getriebenummer / Transmission Number: 2826.5 95719131 / 95719331 Nabenprofil / Hub Profile: 23x30,55x10Z	(26) (46)
			 3000 951 026 ⊗ 3083 039 031 ⊗ 1878 002 072 ⊙ 3151 600 529	235 10 MFZ235X 235VTB KZISZ-2	Getriebenummer / Transmission Number: 2826.5 95719111 / 95719311 / 95719315 / 95719317	(26)
A 40-12 (95819311, 95819315, 95819317, 95819331)	05.96 - 05.99	8140.43	 3400 700 432 ■	280 10 280/Z	Getriebenummer / Transmission Number: 2826.5 95819311 / 95819315 / 95819317 / 95819331 Nabenprofil / Hub Profile: 23x30,55x10Z	(26) (46)
A 45-10 (94159111, 94159131, 94159211, 94159311...)	01.91 - 04.96	8140.27S	 3000 951 026 ⊗ 3083 039 031 ⊗ 1878 002 072 ⊙ 3151 600 529	235 10 MFZ235X 235VTB KZISZ-2	Getriebenummer / Transmission Number: 2826.5 94159131 / 94159331 / 94159335 / 94159337	(26)
			 3400 700 429 ⊗ 3482 907 001 ⊗ 1862 967 001 ⊙ 3151 065 031	265 10 MF265 265TB KZI-1	->Chass. 5928512 Getriebenummer / Transmission Number: 2826.5 94159111 / 94159211 / 94159311 / 94159315 / 94159317	(26)
			 3000 951 026	235 10	Chass. 5928513-> Getriebenummer / Transmission Number: 2826.5	(26)

		CODE					
---	--	------	--	--	---	---	---





IVECO

DAILY II Bus		01.89 - 05.99					
A 45-10 (95739111, 95739131, 95739311, 95739317, 95739331)	05.96 - 05.99	8140.23		3000 951 026	235 10	Getriebeummer / Transmission Number: 2826.5 95739111 / 95739311 / 95739317	(26)
				<ul style="list-style-type: none">  3083 039 031  1878 002 072  3151 600 529 	MFZ235X 235VTB KZISZ-2		
				3400 700 432 	280 10	Getriebeummer / Transmission Number: 2826.5 95739131 / 95739331 Nabenprofil / Hub Profile: 23x30,55x10Z	(46)
A 45-12 (94179211, 94179231, 94179311, 94179317...)	06.90 - 04.96	8140.47		3400 117 701	265 10	Getriebeummer / Transmission Number: 2826.5 94179211 / 94179231 / 94179311 / 94179317 / 94179331 / 94179337	(26)
				<ul style="list-style-type: none">  3482 998 701  1878 997 101  3151 600 529 	MFZ265 265VTP KZISZ-2		
A 45-12 (95839211, 95839231, 95839311, 95839317...)	05.96 - 05.99	8140.43		3400 700 432 	280 10	Getriebeummer / Transmission Number: 2826.5 95839211 / 95839231 / 95839311 / 95839317 / 95839331 / 96039211 / 96039231 / 96039311 / 96039331 / 96039337 Nabenprofil / Hub Profile: 23x30,55x10Z	(46)









Eurorider								
31 35 35 A		F2BE0682A, F2BE0682F		3482 083 113	430	Getr. / GBox: S6-1600		
					MFZ430			
					1878 002 825	430 10	Getr. / GBox: S6-1600	
					430WGTZ			
				3151 000 144	KZISZ-5	Getr. / GBox: S6-1600		
				3496 006 000		Getr. / GBox: S6-1600 langer Bügel / long handle	(86)	

Leoncino							
Leoncino AL 5				1878 600 841	280 10		
					280CTB		

Lupetto							
Lupetto AL 5				1878 600 841	280 10		
					280CTB		

M 2000							
M 2000	01.77 -	8210		3400 119 001 	420 10	enthält Druckplattenbefestigungsschrauben / includes bolt for pressure plate mounting	(64)
				<ul style="list-style-type: none">  3482 085 033  1878 001 138  1874 015 200 	MF420 420GTZ		

Tigrotto							
Tigrotto AL 5				1878 600 841	280 10		
					280CTB		







Zeta		01.79 - 12.92					
A 60-9 A 70-14	09.88 - 12.92 05.88 - 12.92	8060.05.285, 8040.05.203, 8060.05.246, 8040.05.200		3400 700 347	310 10		
				<ul style="list-style-type: none">  3482 125 245  1878 000 611  3151 600 540 	MF310 310TB KZA-4		
					3482 911 001		
				1862 811 001	270 10	Je nach Kundenwunsch mit unterschiedlicher Kupplung / Equipped with different clutch according to customer requirement	(33)
				MF270	270CTB		
A 60-10 A 70-12	11.79 - 06.88 01.83 - 01.85	8340.05.200, 8340.04.040		1882 806 001 	280	09.1983->	
					H280		
				1878 600 841	280 10		
					280CTB		



50...							
50 AL -000378				1878 600 834	250 10		
50 AL 000379-					250CB		

		CODE					
---	--	------	--	--	---	---	---



IVECO





























300...							
300 PC				1861 572 431	420 10 420/210GS		

315...							
315-13				3482 008 033	310 MF310		
				1861 653 132	310 10 310WGSZ		
				3151 199 001	KZIS-3		
315 .8/17 315 /17		8060		3482 012 238	330 GMF330		
				1861 874 032	330 10 330WGSZ		
				3151 199 001	KZIS-3		

316...							
316-13				3482 008 033	310 MF310		
				1861 653 132	310 10 310WGSZ		
				3151 199 001	KZIS-3		

329...							
329 A, B				1878 600 841	280 10 280CTB		



331...							
331 A 001003-				1882 325 134	380 G380		
				1878 000 957	380 10 380GTZ		



370...							
370-10 /20 370-10 /25 370-11 /25 370-12 /25 370-12 /26		8260		3400 119 001   3482 085 033  1878 001 138  1874 015 200	420 10 MF420 420GTZ	->Chass. 006654 enthält Druckplattenbefestigungsschrauben / includes bolt for pressure plate mounting	(64)
				3151 098 031	KZI-4,5	->Chass. 006654	
				3482 125 131	420 MF420	Chass. 006655-> enthält Druckplattenbefestigungsschrauben / includes bolt for pressure plate mounting	(64)
				3151 114 031	KZI-4,5	Chass. 006655->	
370-10 /24 370-12 /24 370-12 /25 L		8210, 8220		3482 125 131	420 MF420	enthält Druckplattenbefestigungsschrauben / includes bolt for pressure plate mounting	(64)
				1878 001 138	420 10 420GTZ		
				3151 098 031	KZI-4,5		
370-12 /26 (Unic)		8210		3400 119 001   3482 085 033  1878 001 138  1874 015 200	420 10 MF420 420GTZ	enthält Druckplattenbefestigungsschrauben / includes bolt for pressure plate mounting	(64)
370-12 /30		8210		3400 042 031   3482 125 131  1878 002 955  1874 015 200	420 10 MF420 420GTZ	enthält Druckplattenbefestigungsschrauben / includes bolt for pressure plate mounting	(64)
				3151 098 031	KZI-4,5		
370-12 /35		8260, 8280		3400 042 031   3482 125 131  1878 002 955  1874 015 200	420 10 MF420 420GTZ	Getr. / GBox: Fiat, ZF enthält Druckplattenbefestigungsschrauben / includes bolt for pressure plate mounting	(64)
				3151 127 031	KZI-4,5	Getr. / GBox: Fiat, ZF	



		CODE				
---	--	------	--	---	---	---

IVECO



370...						
370-S24				3151 207 031	KZIS-4	
370-S25L						
370-S30						
370-S35						
370-SE.27						

380...						
380.29	01.95 -	8460		3482 083 118	430	
380.35	01.95 -				MFZ430	
380.38	01.95 -			1878 085 741	430 10	
					430WGTZ	
				3151 000 144	KZISZ-5	



409...						
409 B				1882 325 134	380	
					G380	
				1878 000 957	380 10	
					380GTZ	

418...						
418 A/AC/AL	05.78 -			1882 325 134	380	
					G380	
				1878 000 957	380 10	
					380GTZ	

KING LONG



XMQ						
XMQ 6900		CumminsISLe42 25B		3482 000 464	395	Getr. / GBox: ZF 6S 950
					MF395	
				1878 000 294	395 10	Getr. / GBox: ZF 6S 950
					395WGTZ	
				3151 000 395	KZIS-4	Getr. / GBox: ZF 6S 950

LAZ

BUS						
Bus		Cummins		3482 083 118	430	Getr. / GBox: ZF-6S 700/1000/1701
					MFZ430	
				1878 080 031	430 10	Getr. / GBox: ZF-6S 700/1000/1701
					430WGTZ	
				3151 000 157	KZISZ-5	Getr. / GBox: ZF-6S 700/1000/1701

MAGIRUS-DEUTZ



O 3500...						
O 3500		F6L614		1861 034 147 #	350 10	
O 3500 V 6					350	









Saturn I - III						
Saturn I (O3500H)				1881 039 532 #	350	
Saturn II /II IS					G350KR	
Saturn III /LS/MS				1878 001 074	350 10	
					350GTZ	
				1863 100 030	GR-3	mit Anlauftring / with thrust ring (88)



110...						
110 E 6				1881 096 444 ▲	280	
					HV280	
				1863 100 030	GR-3	mit Anlauftring / with thrust ring (88)









		CODE					
---	--	------	--	--	---	---	---







MAGIRUS-DEUTZ

130...							
130 L 81 130 R 81		F6L913		3482 008 033	310 MF310		
				1861 653 132	310 10 310WGSZ		
				3151 199 001	KZIS-3		

150...							
150 E 100				1881 039 532 #	350 G350KR		
				1878 005 367	350 10 350WGTZ		
150 R/L 10 150 S 10		F6L312		1881 039 532 #	350 G350KR		
				1878 005 367	350 10 350WGTZ		
150 R/L 10, 12				1881 039 532 #	350 G350KR		
				1878 001 074	350 10 350GTZ		
				1863 100 030	GR-3	mit Anlauftring / with thrust ring	(88)
150 S 11 M		F6L413		1881 041 656 #	380 G380		
				1861 351 342 #	380 10 380WGSZ		



160...							
160 L 81 160 R 81				3482 012 211	330 GMF330		
				1861 874 032	330 10 330WGSZ		
				3151 199 001	KZIS-3		



170...							
170 E 100 170 TR 100 (Version 2547212)		F6L413		1881 039 532 #	350 G350KR		
				1878 005 367	350 10 350WGTZ		
				1863 100 030	GR-3	mit Anlauftring / with thrust ring	(88)
170 L 100 170 R 100 170 TR 100				1881 039 532 #	350 G350KR		
				1878 005 367	350 10 350WGTZ		
				1863 100 030	GR-3	mit Anlauftring / with thrust ring	(88)
170 SH 110		F6L413		1881 041 656 #	380 G380		
				1861 351 342 #	380 10 380WGSZ		























200...							
200 E 12 200 R/L		F8L312		1881 041 656 #	380 G380		
				1861 351 342 #	380 10 380WGSZ		
200 E 110				1882 325 134	380 G380		
				1861 351 342 #	380 10 380WGSZ		
				1863 101 100 ▲	GR-4	mit Anlauftring / with thrust ring	(88)
200 LS /RS 12		F8L312, F8L413		1881 041 656 #	380 G380		
				1861 351 342 #	380 10 380WGSZ		

		CODE				
---	--	------	--	---	---	---

MAGIRUS-DEUTZ















200...						
200 SH 110			 1881 041 656 #	380 G380		
			 1861 351 342 #	380 10 380WGSZ		

















220...						
226 L 117			 3482 124 532	430 GMF430	Getr. / GBox: S 4-90	
			 1878 001 154 #	420 10 420WGTZ	Getr. / GBox: S 4-90	
			 3151 000 515	KZIS-4	Getr. / GBox: S 4-90	

230...						
230 E 100 230 E 110			 1882 325 134	380 G380		
			 1861 351 342 #	380 10 380WGSZ		
			 3151 000 395	KZIS-4		
230 E 100 (Version 2547021)			 1881 039 532 #	350 G350KR		
			 1878 005 367	350 10 350WGTZ		
			 1863 100 030	GR-3	mit Anlauftring / with thrust ring	(88)
230 E 113 (Version 2547018) 230 L 120 230 T 117			 1882 325 134	380 G380		
			 1861 351 342 #	380 10 380WGSZ		
230 E 113 (Version 42246020/42/71) 230 E 117 230 T 117 (Version 42246022)			 1882 325 134	380 G380		
			 1878 001 152	380 10 380WGTZ		
			 3151 000 515	KZIS-4		
230 E 113 (Version 42246069)			 1882 325 139	380 G380		
			 1878 001 152	380 10 380WGTZ		
			 3151 000 515	KZIS-4		
230 E 113 (Version 42246073)			 3482 124 531	430 GMF430		
			1882 316 035 ●#	420 GF420		
			 1878 001 154 #	420 10 420WGTZ		
			1878 003 657 ●	420 10 420WGTZ		
			 3151 000 515	KZIS-4		
230 E 120			 1882 325 134	380 G380		
			 1861 351 342 #	380 10 380WGSZ		
			 1863 101 100 ▲	GR-4	mit Anlauftring / with thrust ring	(88)
230 EV 110 230 EV 120			 1882 325 134	380 G380		
			 1878 001 152	380 10 380WGTZ		
			 3151 000 395	KZIS-4		

		CODE					
---	--	------	--	--	---	---	---



MAGIRUS-DEUTZ

230...								
230 L 117				1882 325 134	380 G380	Getr. / GBox: S 6-70/3 Getr. / GBox: S 6-65		
				1861 351 342 #	380 10 380WGSZ	Getr. / GBox: S 6-70/3		
				1878 001 152	380 10 380WGTZ	Getr. / GBox: S 6-65		
				3151 199 001	KZIS-3	Getr. / GBox: S 6-70/3 Getr. / GBox: S 6-65		
			F8L413F		3482 124 532	430 GMF430	Getr. / GBox: S 6-65	
					1878 001 154 #	420 10 420WGTZ	Getr. / GBox: S 6-65	
					3151 000 515	KZIS-4	Getr. / GBox: S 6-65	
230 R 100 230 R 120 230 TR 100 230 TR 120		F8L413		1882 325 134	380 G380			
				1861 351 342 #	380 10 380WGSZ			
				1863 101 100 ▲	GR-4	mit Anlauftring / with thrust ring	(88)	
230 SH 110				1882 325 134	380 G380	Getr. / GBox: S 6-70/3		
				1861 351 342 #	380 10 380WGSZ	Getr. / GBox: S 6-70/3		
				3151 199 001	KZIS-3	Getr. / GBox: S 6-70/3		
		F8L914		1882 325 139	380 G380			
				1878 000 957	380 10 380GTZ			

260...							
260 E 113 (Version 42246065/70)				1882 325 139	380 G380		
				1878 001 152	380 10 380WGTZ		
				3151 000 515	KZIS-4		
260 E 113 (Version 42246068) 260 T 117				1882 325 134	380 G380		
				1878 001 152	380 10 380WGTZ		
				3151 000 515	KZIS-4		
260 E 113 (Version 42246073/79)				3482 124 531	430 GMF430		
				1882 316 035 ●#	420 GF420		
				1878 001 154 #	420 10 420WGTZ		
				1878 003 657 ●	420 10 420WGTZ		
				3151 000 515	KZIS-4		
260 L 117				1882 325 134	380 G380	Getr. / GBox: S 6-65	
				1878 001 152	380 10 380WGTZ	Getr. / GBox: S 6-65	
				3151 199 001	KZIS-3	Getr. / GBox: S 6-65	
		F8L413F		3482 124 532	430 GMF430	Getr. / GBox: S 6-65	
				1878 001 154 #	420 10 420WGTZ	Getr. / GBox: S 6-65	
				3151 000 515	KZIS-4	Getr. / GBox: S 6-65	

		CODE					
---	--	------	--	--	---	---	---

MAGIRUS-DEUTZ

260...							
260 R 106 260 R 119				3482 124 531	430		
				1882 316 035 ●#	420		
				1878 003 657	420 10		
				3151 000 515	420WGTZ		
260 SH 110		F8L413F		3482 124 532	430	Getr. / GBox: S 6-65	
				1878 001 154 #	420 10	Getr. / GBox: S 6-65	
				3151 000 515	420WGTZ	Getr. / GBox: S 6-65	









280...							
280 E 113				3482 124 531	430		
				1882 316 035 ●#	420		
				1878 001 154 #	420 10		
				1878 003 657 ●	420 10		
				3151 000 515	420WGTZ		

2000							
2000		F8L413F		3482 124 532	430	Getr. / GBox: S 6-65	
				1878 001 152	380 10	Getr. / GBox: S 6-65	
				3151 000 515	380WGTZ	Getr. / GBox: S 6-65	

MAN

EL 01.93 - 01.01							
EL 202,EL 222 A12	01.93 - 06.97	D0826LUH03, D0826LUH12, D0826LUH05, D0826LUH, D2866LUH22		3482 086 132	400	A12	
EL 202,EL 262 A12	04.94 - 06.97			1862 364 133	400 10	A12	
EL 262 A12	07.98 -			3151 000 034	400WGVZ	A12	















EM 08.87 -							
EM 192 469	10.93 - 06.97	D0826LOH15, D0826LOH06		3482 060 132	350		
EM 223 469	08.87 -			1878 000 841 #	350 10		
				3151 199 001	350WGTZ		

G 10.79 - 08.88							
8.136 FOC 563	03.82 - 07.88	D0226		3400 124 201 #	280 28	Fahrzeug kann mit unterschiedlichen Kupplungsgrößen ausgerüstet sein / vehicle can be mounted with different clutch sizes	(20)
				3482 032 331	MFZ280		
9.136 FOC 563	03.82 - 07.88			1861 841 132	280GTPZ	Fahrzeug kann mit unterschiedlichen Kupplungsgrößen ausgerüstet sein / vehicle can be mounted with different clutch sizes	(20)
				3151 600 541	KZIZ-2		
				3400 125 801	310 28	Fahrzeug kann mit unterschiedlichen Kupplungsgrößen ausgerüstet sein / vehicle can be mounted with different clutch sizes	(20)
				3482 102 031	MFZ310		
				1862 219 031	310GTPD	Fahrzeug kann mit unterschiedlichen Kupplungsgrößen ausgerüstet sein / vehicle can be mounted with different clutch sizes	(20)
				3151 600 541	KZIZ-2		
				3482 060 132	350	Fahrzeug kann mit unterschiedlichen Kupplungsgrößen ausgerüstet sein / vehicle can be mounted with different clutch sizes	(20)
				1861 777 041 #	MF350		
				3151 199 001	350 10		

		CODE					
---	--	------	--	--	---	---	---

MAN









G 90		09.87 - 05.95					
8.150 FOC L05	07.88 - 10.93	D0826F, GF		3400 125 801 ⊗ 3482 102 031 ⊗ 1862 219 031 ⊙ 3151 600 541	310 28 MFZ310 310GTPD KZISZ-2	L02,03,05	
8.170 FOC L05	02.89 - 10.93						
9.150 FOC L05	07.88 - 10.93						
9.170 FOC L05	02.89 - 10.93						

LION S COACH		09.95 -					
FRH 352,RH 353 A13	09.95 -	D2866LOH26		3400 700 362 ⊗ 3482 083 032 ⊗ 1878 080 033 ⊙ 3151 000 034	430 10 MFZ430 430WGTZ KZISZ-5	Getr. / GBox: ZF 8S-180	
FRH 402,RH 403 A13	09.95 -	D2866LOH23		3400 122 301 ⊗ 3482 083 032 ⊗ 1878 080 034 ⊙ 3151 000 034	430 10 MFZ430 430WGTZ KZISZ-5	Getr. / GBox: ZF 8S-180	
RH 352 A13	05.96 -	D2866LOH		3400 122 301 ⊗ 3482 083 032 ⊗ 1878 080 034 ⊙ 3151 000 034	430 10 MFZ430 430WGTZ KZISZ-5	Getr. / GBox: ZF 8S-180 Länderausführung: Türkei / Country Version: Turkey	(41)
RH 422 A13	05.96 -						
RH 402 A13	05.96 -	D2866LOH, Euro2/3		3400 122 301 ⊗ 3482 083 032 ⊗ 1878 080 034 ⊙ 3151 000 034	430 10 MFZ430 430WGTZ KZISZ-5	Getr. / GBox: ZF 8S-180 Länderausführung: Türkei / Country Version: Turkey	(41)
RH 403 A32	09.98 -	D2866LOH23		3400 122 301 ⊗ 3482 083 032 ⊗ 1878 080 034 ⊙ 3151 000 034	430 10 MFZ430 430WGTZ KZISZ-5	Getr. / GBox: ZF 8S-180 A32 Länderausführung: Türkei / Country Version: Turkey	(41)
RH 463, RHC 464 R08 A32	01.00 -	D2876LOH		3400 122 301 ⊗ 3482 083 032 ⊗ 1878 080 034 ⊙ 3151 000 034	430 10 MFZ430 430WGTZ KZISZ-5	Getr. / GBox: ZF 8S-180 A32 Länderausführung: Türkei / Country Version: Turkey	(41)
		D2876LOH3		3482 083 032	430 MFZ430	Getr. / GBox: ZF 8S-180 R07,R08	
				1878 080 037	430 10 430WGTZ	Getr. / GBox: ZF 8S-180 R07,R08	
				3151 000 034	KZISZ-5	Getr. / GBox: ZF 8S-180 R07,R08	
				3400 700 511	430 10	XTend Getr. / GBox: ZF 8S-180 R07,R08 Nabenprofil / Hub Profile: 41,1x50,8-10N Nur zusammen verbauen / Only install together	(46) (51)
				3400 700 505	430 10	XTend Getr. / GBox: ZF 8S-180 R07,R08 Nabenprofil / Hub Profile: 41,1x50,8-10N Nur zusammen verbauen / Only install together	(46) (51)
				6594 000 124	430 430Z	Getr. / GBox: ZF 8S-180 R07,R08 enthält Schwungradbefestigungsschrauben / includes bolt for flywheel mounting	(65)
				3400 700 404 ⊗ 3482 000 246 ⊗ 1878 002 139 ⊙ 3151 000 144	430 10 MFZ430 430WGTZ KZISZ-5	Getr. / GBox: AS-Tronic R07,R08	
				3400 700 445 ⊗ 3482 000 246 ⊗ 1878 002 139 ⊙ 3151 000 493	430 10 MFZ430 430WGTZ KZISZ-5	Getr. / GBox: AS-Tronic R07,R08 für Ausrückgabel mit Rollen / for release fork with rollers	(70)
				3400 700 459 HD ⊗ 3482 000 246 ⊗ 1878 004 104 ⊙ 3151 000 493	430 10 MFZ430 430WGTZ KZISZ-5	Getr. / GBox: AS-Tronic R07,R08 für Ausrückgabel mit Rollen / for release fork with rollers	(70)















		CODE					
---	--	------	--	--	---	---	---

MAN

LION S COACH 09.95 -

RHC 414 R07	06.02 -	D2866LOH34		3400 122 301 3482 083 032 1878 080 034 3151 000 034	430 10 MFZ430 430WGTZ KZISZ-5	Getr. / GBox: ZF 8S-180 R07,R08	
				3400 700 512 	430 10	XTend Getr. / GBox: ZF 8S-180 R07,R08 Nabenprofil / Hub Profile: 41,1x50,8-10N Nur zusammen verbauen / Only install together	(46) (51)
				3400 700 507 	430 10	XTend Getr. / GBox: ZF 8S-180 R07,R08 Nabenprofil / Hub Profile: 41,1x50,8-10N Nur zusammen verbauen / Only install together	(46) (51)
				6594 000 124	430 430Z	Getr. / GBox: ZF 8S-180 R07,R08 enthält Schwungradbefestigungsschrauben / includes bolt for flywheel mounting	(65)
				3482 000 361	430 MFZ430	Getr. / GBox: AS-Tronic R07,R08	
				1878 080 034	430 10 430WGTZ	Getr. / GBox: AS-Tronic R07,R08	
				3151 000 144	KZISZ-5	Getr. / GBox: AS-Tronic R07,R08	









LION'S REGIO

Lion's Regio L R13	04.03 -			3482 000 361	430 MFZ430	Getr. / GBox: AS-Tronic R13	
				1878 080 034	430 10 430WGTZ	Getr. / GBox: AS-Tronic R13	
				3151 000 144	KZISZ-5	Getr. / GBox: AS-Tronic R13	
				3400 700 507 	430 10	XTend Getr. / GBox: ZF 6S-1900 R13 Nabenprofil / Hub Profile: 41,1x50,8-10N Nur zusammen verbauen / Only install together	(46) (51)
Lion's Regio R12				3482 000 361	430 MFZ430	Getr. / GBox: AS-Tronic R12	
				1878 080 034	430 10 430WGTZ	Getr. / GBox: AS-Tronic R12	
				3151 000 144	KZISZ-5	Getr. / GBox: AS-Tronic R12	
		D2866LUH29/3 7		3400 700 507 	430 10	XTend Getr. / GBox: ZF 6S-1900 R12 Nabenprofil / Hub Profile: 41,1x50,8-10N Nur zusammen verbauen / Only install together	(46) (51)
				3400 700 512 	430 10	XTend Getr. / GBox: GO 210-6 R12 Nabenprofil / Hub Profile: 41,1x50,8-10N Nur zusammen verbauen / Only install together	(46) (51)
				3400 700 506 	430 10	XTend Getr. / GBox: ZF 6S-1900 R12 Nabenprofil / Hub Profile: 41,1x50,8-10N Nur zusammen verbauen / Only install together	(46) (51)



























		CODE				
---	--	------	--	---	---	---

MAN

LION'S REGIO

Lion's Regio 13M R14	D2866LUH29/3 7	 3482 000 361	430 MFZ430	Getr. / GBox: AS-Tronic R14	
		 1878 080 034	430 10 430WGTZ	Getr. / GBox: AS-Tronic R14	
		 3151 000 144	KZISZ-5	Getr. / GBox: AS-Tronic R14	
	D2866LUH28	 3400 700 507 	430 10	XTend Getr. / GBox: ZF 6S-1900 R14 Nabenprofil / Hub Profile: 41,1x50,8-10N Nur zusammen verbauen / Only install together	(46) (51)
		 3400 700 512 	430 10	XTend Getr. / GBox: GO 210-6 R14 Nabenprofil / Hub Profile: 41,1x50,8-10N Nur zusammen verbauen / Only install together	(46) (51)
			 3400 700 506 	430 10	XTend Getr. / GBox: ZF 6S-1900 R14 Nabenprofil / Hub Profile: 41,1x50,8-10N Nur zusammen verbauen / Only install together









LION S STAR 03.91 -

FRH 322 A03	D2865, 2866LOH	 3482 062 035	430 GMFZ430	01.1991-> Getr. / GBox: ZF6S-85	
		 1878 061 841	430 10 430WGTZ	01.1991-> Getr. / GBox: ZF6S-85	
		 3151 000 034	KZISZ-5	01.1991-> Getr. / GBox: ZF6S-85	
		 3482 083 032	430 MFZ430	01.1991-> Getr. / GBox: ZF8S-180	
		 1878 085 641	430 10 430GTZ	01.1991-> Getr. / GBox: ZF6S-180	
		 3151 000 034	KZISZ-5	01.1991-> Getr. / GBox: ZF8S-180	
	D2876LOH	 6594 000 124	430 430Z	Getr. / GBox: 8 S 180 + Int. für OE-Nummer / for OE number 51.02301.6044 enthält Schwungradbefestigungsschrauben / includes bolt for flywheel mounting	(83) (65)
FRH 352,RH 353 A03	09.95 - D2866LOH26	 3400 122 301	430 10 MFZ430	Getr. / GBox: ZF 8S-180	
		 3482 083 032	430WGTZ		
		 1878 080 034	KZISZ-5		
		 3151 000 034			
		 3482 083 032	430 MFZ430	Getr. / GBox: ZF 8S-180 Getr. / GBox: ZF 6S-85	
		 1878 080 031	430 10 430WGTZ	Getr. / GBox: ZF 6S-85	
		 3151 000 034	KZISZ-5	Getr. / GBox: ZF 8S-180 Getr. / GBox: ZF 6S-85	
FRH 402 A03	04.91 - 09.92 D2865LOH, D2866LOH, D2876LOH01	 3400 122 301	430 10 MFZ430	Getr. / GBox: ZF 8S-180	
		 3482 083 032	430WGTZ		
FRH 402,RH 403 A03	09.95 - D2866LOH23	 1878 080 034	KZISZ-5		
		 3400 122 301	430 10 MFZ430	Getr. / GBox: ZF 8S-180	
		 3482 083 032	430WGTZ		
		 1878 080 034	KZISZ-5		
FRH 422 A03	01.93 - 09.96 D2865, 2866LOH	 3482 083 032	430 MFZ430	Getr. / GBox: ZF8S-180	
		 1878 085 641	430 10 430GTZ	Getr. / GBox: ZF8S-180	
		 3151 000 034	KZISZ-5	Getr. / GBox: ZF8S-180	
		 3482 062 035	430 GMFZ430	Getr. / GBox: ZF6S-85	
		 1878 061 841	430 10 430WGTZ	Getr. / GBox: ZF6S-85	
	 3151 000 034	KZISZ-5	Getr. / GBox: ZF6S-85		
	D2876LOH	 6594 000 124	430 430Z	Getr. / GBox: 8 S 180 + Int. für OE-Nummer / for OE number 51.02301.6044 enthält Schwungradbefestigungsschrauben / includes bolt for flywheel mounting	(83) (65)











		CODE					
---	--	------	--	--	---	---	---

MAN







LION S STAR 03.91 -

FRH 462 A03	04.91 -	D2865LOH, D2866LOH, D2876LOH01		3400 122 301 ⊗ 3482 083 032 ⊗ 1878 080 034 ⊙ 3151 000 034	430 10 MFZ430 430WGTZ KZISZ-5	Getr. / GBox: ZF 8S-180	
RH 414, RHS 414 R03 RH 464, RHS 464 R03	01.02 -	D2876LOH03, D2866LOH34		3400 700 404 ⊗ 3482 000 246 ⊗ 1878 002 139 ⊙ 3151 000 144	430 10 MFZ430 430WGTZ KZISZ-5	Getr. / GBox: AS-Tronic R03	
	01.02 -			3400 700 445 ⊗ 3482 000 246 ⊗ 1878 002 139 ⊙ 3151 000 493	430 10 MFZ430 430WGTZ KZISZ-5	Getr. / GBox: AS-Tronic R03 für Ausrückgabel mit Rollen / for release fork with rollers	(70)
				3400 700 459 HD ⊗ 3482 000 246 ⊗ 1878 004 104 ⊙ 3151 000 493	430 10 MFZ430 430WGTZ KZISZ-5	Getr. / GBox: AS-Tronic R03 für Ausrückgabel mit Rollen / for release fork with rollers	(70)
RH 464, RHS 464 R02	03.00 -	D2876LOH03		6594 000 124	430 430Z	Getr. / GBox: ZF 8S-180 Getr. / GBox: ZF AS-Tronic enthält Schwungradbefestigungsschrauben / includes bolt for flywheel mounting	(65)
				3482 083 032	430 MFZ430	Getr. / GBox: ZF 8S-180 Getr. / GBox: ZF AS-Tronic	
				1878 085 641	430 10 430GTZ	Getr. / GBox: ZF 8S-180 Getr. / GBox: ZF AS-Tronic	
				3151 000 157	KZISZ-5	Getr. / GBox: ZF 8S-180 Getr. / GBox: ZF AS-Tronic	

N 03.02 -



































N 4516 Centro-E 486	03.02 -	D2866LUH23		3482 083 032	430 MFZ430	Getr. / GBox: ZF S6-85	
				1878 080 031	430 10 430WGTZ	Getr. / GBox: ZF S6-85	
				3151 000 034	KZISZ-5	Getr. / GBox: ZF S6-85	
				3400 700 510 	430 10	XTend Getr. / GBox: ZF S6-85 Nabenprofil / Hub Profile: 38,2x44,5-10N Nur zusammen verbauen / Only install together	(46) (51)
N 4516 Centro-E 486	03.02 -	D2866LUH24		3482 083 032	430 MFZ430	Getr. / GBox: ZF S6-85	
				1878 080 031	430 10 430WGTZ	Getr. / GBox: ZF S6-85	
				3151 000 034	KZISZ-5	Getr. / GBox: ZF S6-85	
				3400 700 510 	430 10	XTend Getr. / GBox: ZF S6-85 Nabenprofil / Hub Profile: 38,2x44,5-10N Nur zusammen verbauen / Only install together	(46) (51)

NL 09.88 -

NL 202, NL 222, NL 223 A21 A10	08.92 -	D0836LUH02		3482 083 032	430 MFZ430	Getr. / GBox: S 6-85 für OE-Nummer / for OE number 81.30305.0193 A20, A21	(83)
				1878 080 031	430 10 430WGTZ	Getr. / GBox: S 6-85 für OE-Nummer / for OE number 81.30301.0497 A20, A21	(83)
				3151 000 034	KZISZ-5	Getr. / GBox: S 6-85 für OE-Nummer / for OE number 81.30550.0094 A20, A21	(83)
NL 202, NL 262, NL 263 A21 A10	04.91 -	D0836LUH02		3482 083 032	430 MFZ430	Getr. / GBox: S 6-85 für OE-Nummer / for OE number 81.30305.0193 A20, A21	(83)
				1878 080 031	430 10 430WGTZ	Getr. / GBox: S 6-85 für OE-Nummer / for OE number 81.30301.0497 A20, A21	(83)
				3151 000 034	KZISZ-5	Getr. / GBox: S 6-85 für OE-Nummer / for OE number 81.30550.0094 A20, A21	(83)
		D2866LUH23		3482 062 035	430 GMFZ430	Getr. / GBox: S 6-85 für OE-Nummer / for OE number 81.30305.0189 A20, A21	(83)

		CODE					
---	--	------	--	--	---	---	---







MAN

NL		09.88 -					
NL 223 A21	01.96 -	D2865LUH		3482 083 032	430 MFZ430		
NL 263 A21	01.96 -			1878 080 031	430 10 430WGTZ		
NL 313 A21	01.96 -			3151 000 034	KZISZ-5		
NL 262, NL 263 A10 A21	07.98 -	D2866LUH23		3482 062 035	430 GMFZ430	Getr. / GBox: S 6-85 für OE-Nummer / for OE number 81.30305.0189 A20, A21	(83)
NL 313 A22 A21	07.98 -			1878 080 031	430 10 430WGTZ	Getr. / GBox: S 6-85 für OE-Nummer / for OE number 81.30301.0497 A20, A21	(83)
				3151 000 034	KZISZ-5	Getr. / GBox: S 6-85 für OE-Nummer / for OE number 81.30550.0094 A20, A21	(83)
NM		08.87 -					
NM 152 469	05.90 - 10.93	D0826LOH01, D0826LOH15, D0826OH02		3482 060 132	350 MF350		
NM 182, NM 192 469	05.90 - 03.97			1878 000 841 #	350 10 350WGTZ		
NM 223 469	08.87 -			3151 199 001	KZIS-3		
NM 222, NM 223 A53	02.96 -	D0826LUH12, D0826LOH15		3482 060 132	350 MF350	Getr. / GBox: ZF S6-36/6S-890	
				1878 000 841 #	350 10 350WGTZ	Getr. / GBox: ZF S6-36/6S-890	
				3151 199 001	KZIS-3	Getr. / GBox: ZF S6-36/6S-890	
				3482 060 132	350 MF350	Getr. / GBox: Eaton 4106	
				1878 001 145	350 10 350WGTZ	Getr. / GBox: Eaton 4106	
				3151 199 001	KZIS-3	Getr. / GBox: Eaton 4106	
NÜ		03.96 -					
NÜ 223 A20	09.96 -	D0826LUH12		3482 086 132	400 MFZ400X		
				1878 000 650	400 10 400WGVZ		
				3151 000 034	KZISZ-5		
NÜ 263 A20	07.98 -	D0826LUH13		3482 086 132	400 MFZ400X	A20	
				1878 000 650	400 10 400WGVZ	A20	
				3151 000 034	KZISZ-5	A20	
NÜ 263 A20	09.96 - 07.98	D2865LUH09		3482 086 132	400 MFZ400X	A20	
				1878 000 650	400 10 400WGVZ	A20	
				3151 000 034	KZISZ-5	A20	
NÜ 263	07.98 -	D2866LUH22		3482 083 032	430 MFZ430	A20	
				1878 080 031	430 10 430WGTZ	A20	
				3151 000 034	KZISZ-5	A20	
				3400 700 510 	430 10	XTend A20 Nabenprofil / Hub Profile: 38,2x44,5-10N Nur zusammen verbauen / Only install together	(46) (51)
NÜ 313 A20	07.98 -	D2866LUH26		3482 083 032	430 MFZ430	A20	
				1878 080 031	430 10 430WGTZ	A20	
				3151 000 034	KZISZ-5	A20	
				3400 700 510 	430 10	XTend A20	











		CODE					
---	--	------	--	--	---	---	---

MAN

NÜ 03.96 -

NÜ 313 15M A25	07.98 -	D2866LUH26		3482 083 032	430 MFZ430		
				1878 080 031	430 10 430WGTZ		
				3151 000 034	KZISZ-5		
				3400 700 510 	430 10 XTend Nabenprofil / Hub Profile: 38,2x44,5-10N Nur zusammen verbauen / Only install together	(46) (51)	
NÜ 353 15M A25	07.98 -	D2866LUH21		3400 700 362  3482 083 032  1878 080 033  3151 000 034	430 10 MFZ430 430WGTZ KZISZ-5		

R 05.85 - 01.93

R 292, FR 292, FRH 292 882 880	05.85 - 01.93	D2866TUH/290, D2866TOH/310		1882 342 134	420 GF420X	880	
				1878 003 657	420 10 420WGTZ	880	
				3151 000 395	KZIS-4	880	
				3482 124 549	430 GMF430	882	
				1878 086 741	420 10 430WGTZ	882	
				3151 000 395	KZIS-4	882	
				1882 342 134	420 GF420X	882 je nach Ausführung, mit unterschiedlicher Kupplung / depending on version, with different clutch	(85)
				1878 003 657	420 10 420WGTZ	882 je nach Ausführung, mit unterschiedlicher Kupplung / depending on version, with different clutch	(85)
FRH 362 882	05.85 - 12.92	D2866KUH/360		1882 342 134	420 GF420X		
				1878 003 657	420 10 420WGTZ		
				3151 000 395	KZIS-4		









SG 09.72 -

SG 220 297		D2556		3482 124 541	430 GMF430		
				3482 006 036 	420 GTF420		
				1882 330 032 	420 GF420		
				1878 001 154 #	420 10 420WGTZ		
				3151 000 395	KZIS-4	mit Dauerschmierung / with constant lubrication	(89)
				3151 000 512	KZIS-4	mit Schmierrohranschluß / with lubricating pipe coupling	(91)











		CODE				
---	--	------	--	---	---	---

MAN



SL 06.72 - 04.87

SL 200		D2555	 1882 302 131	380 GF380	192	
			 1878 001 152	380 10 380WGTZ	192	
			 3151 000 395	KZIS-4	192 mit Dauerschmierung / with constant lubrication	(89)
			 3151 000 512	KZIS-4	192 mit Schmierrohranschluß / with lubricating pipe coupling	(91)
		D2556	 3482 124 534	430 GMF430	192	
			1882 301 239 ●	420 GF420	192	
			 1878 001 154 #	420 10 420WGTZ	192	
			 3151 000 395	KZIS-4	192 mit Dauerschmierung / with constant lubrication	(89)
			 3151 000 512	KZIS-4	192 mit Schmierrohranschluß / with lubricating pipe coupling	(91)









SL II 04.84 - 05.96

SL 202 791 SL 202 791	06.84 - 04.93	D2566UH, D2866UH/240	 3482 124 550	430 GMF430	->06.1991 791	
			 3482 006 036 ●#	420 GTF420	->06.1991 791	
	 1878 001 154 #		420 10 420WGTZ	->06.1991 791		
	 3151 000 395		KZIS-4	->06.1991 791		
	 3482 124 550		430 GMF430	Sonderausführung / Special design	(56)	
	 3482 006 036 ●#		420 GTF420	Sonderausführung / Special design	(56)	
	 1878 002 706		420 10 420GTZ	Sonderausführung / Special design	(56)	
	 3482 085 034		420 MF420	07.1991-> 791		
	 1878 001 154 #		420 10 420WGTZ	07.1991-> 791		
	 3151 000 395		KZIS-4	07.1991-> 791		

SM 08.87 -

































SM 152 469 SM 182, SM 192 469	11.87 - 04.94	D0826LOH01, D0826OH02	 3482 060 132	350 MF350		
	11.87 - 02.95		 1878 000 841 #	350 10 350WGTZ		
			 3151 199 001	KZIS-3		

SR 02.75 - 08.94

SR 240 289 197 595 596	10.75 - 06.83	D2566MUH/240	 3482 124 534	430 GMF430	Länderausführung: Türkei / Country Version: Turkey	(41)
			 1882 301 239 ●	420 GF420	Länderausführung: Türkei / Country Version: Turkey	(41)
			 1878 001 154 #	420 10 420WGTZ	Länderausführung: Türkei / Country Version: Turkey	(41)
			 3151 000 512	KZIS-4	Länderausführung: Türkei / Country Version: Turkey	(41)
			 3482 124 550	430 GMF430	197	
			 3482 006 036 ●#	420 GTF420	197	
			 1878 001 154 #	420 10 420WGTZ	197	
			 3151 000 395	KZIS-4	197 mit Dauerschmierung / with constant lubrication	(89)
			 3151 000 512	KZIS-4	197 mit Schmierrohranschluß / with lubricating pipe coupling	(91)





































		CODE					
---	--	------	--	--	---	---	---

MAN

SR		02.75 - 08.94					
SR 280,SR 280 H 595 289 596 288	01.77 - 11.86	D2566MTUH	 3482 124 550	430 GMF430	197		
			 3482 006 036 ●#	420 GTF420	197		
			 1878 003 657	420 10 420WGTZ	197		
			 3151 000 512	KZIS-4	197		
			 3482 124 550	430 GMF430	288		
			 3482 006 036 ●#	420 GTF420	288		
			 1878 003 657	420 10 420WGTZ	288		
			 3151 000 512	KZIS-4	288		
SR 281 SR 321 H 288	03.82 - 11.86	D2566MKUH/32 0	 1882 342 134	420 GF420X			
			 1861 911 232	420 10 420WGVZ			
			 3151 000 395	KZIS-4			
SR 292 880 882	- 07.90	D2866TUH	 1882 342 134	420 GF420X			
			 1878 002 706	420 10 420GTZ			
			 3151 000 395	KZIS-4			
SR 292 882 880	08.90 -	D2866TUH	 3482 124 549	430 GMF430			
			 1882 342 135 ●#	420 GF420X			
			 1878 086 741	420 10 430WGTZ			
			 3151 000 395	KZIS-4			
SR 332 H 882	- 07.90	D2866LUH	 1882 342 134	420 GF420X			
			 1878 002 706	420 10 420GTZ			
			 3151 000 395	KZIS-4			
SR 332 H 882	08.90 -	D2866LUH	 3482 124 549	430 GMF430			
			 1882 342 135 ●#	420 GF420X			
			 1878 086 741	420 10 430WGTZ			
			 3151 000 395	KZIS-4			
SR 361 SR 362 H 882	08.90 -	D2866KUH	 3482 124 549	430 GMF430			
			 1882 342 135 ●#	420 GF420X			
			 1878 086 741	420 10 430WGTZ			
			 3151 000 395	KZIS-4			
SR 362 H 882	- 07.90	D2866KUH	 1882 342 134	420 GF420X			
			 1878 002 706	420 10 420GTZ			
			 3151 000 395	KZIS-4			

		CODE					
---	--	------	--	--	---	---	---



























MAN

SÜ		10.75 -					
SÜ 18.223 (Türkei) A72	05.99-	D2866LUH26	 3400 700 362  3482 083 032  1878 080 033  3151 000 034	430 10 MFZ430 430WGTZ KZISZ-5			
SÜ 18.253 (Türkei) A72	05.99-	D0826LOH	 3482 086 132	400 MFZ400X			
SÜ 18.263 (Türkei) A72	05.99-		 1878 000 650	400 10 400WGVZ			
SÜ 18.313 (Türkei) A72	05.99-		 3151 000 034	KZISZ-5			
SÜ 210			 1878 001 155 ▲#	420 10 420WGTZ			
			 1863 009 100	GR-5	mit Anlaufring / with thrust ring		(88)
SÜ 224 193		D2555	 1882 302 131	380 GF380			
			 1878 001 152	380 10 380WGTZ			
			 3151 000 395	KZIS-4	mit Dauerschmierung / with constant lubrication		(89)
		D2556	 3151 000 512	KZIS-4	mit Schmierrohranschluß / with lubricating pipe coupling		(91)
			 3482 124 541	430 GMF430			
			 1882 330 032 ●#	420 GF420			
			 3482 006 036 ●#	420 GTF420			
			 1878 001 154 #	420 10 420WGTZ			
			 3151 000 395	KZIS-4	mit Dauerschmierung / with constant lubrication		(89)
			 3151 000 512	KZIS-4	mit Schmierrohranschluß / with lubricating pipe coupling		(91)
SÜ 230 SÜ 240	01.72-	D2556	 3482 124 541	430 GMF430			
			 1882 330 032 ●#	420 GF420			
			 3482 006 036 ●#	420 GTF420			
			 1878 001 154 #	420 10 420WGTZ			
			 3151 000 395	KZIS-4	mit Dauerschmierung / with constant lubrication		(89)
			 3151 000 512	KZIS-4	mit Schmierrohranschluß / with lubricating pipe coupling		(91)
SÜ 240 789 193	05.80 - 09.89	D2566	 3482 124 550	430 GMF430	789		
SÜ 240 193 789	10.75 - 01.86		 3482 006 036 #	420 GTF420	789		
			 1878 001 154 #	420 10 420WGTZ	789		
			 3151 000 395	KZIS-4	789 mit Dauerschmierung / with constant lubrication		(89)
			 3151 000 512	KZIS-4	789 mit Schmierrohranschluß / with lubricating pipe coupling		(91)
		D2566MUH	 3482 124 541	430 GMF430	193		
			 1882 330 032 ●#	420 GF420	193		
			 1878 001 154 #	420 10 420WGTZ	193		
			 3151 000 395	KZIS-4	193		
SÜ 240 789	01.86 - 09.89	D2866TOH/290, D2866UH/240	 3482 006 036 #	420 GTF420			
SÜ 240 789	01.86 - 09.89		 1878 003 657	420 10 420WGTZ			
			 3151 000 395	KZIS-4			



		CODE					
---	--	------	--	--	---	---	---

MAN

SÜ 10.75 -























SÜ 240 789	11.82 - 01.86	D2566		3482 124 550	430 GMF430	789	
				3482 006 036 #	420 GTF420	789	
				1878 001 154 #	420 10 420WGTZ	789	
				3151 000 395	KZIS-4	789 mit Dauerschmierung / with constant lubrication	(89)
				3151 000 512	KZIS-4	789 mit Schmierrohranschluß / with lubricating pipe coupling	(91)
SÜ 242 888	01.87 - 04.93	D2866UH/240		3482 085 034	420 MF420		
				1878 001 154 #	420 10 420WGTZ		
				3151 000 395	KZIS-4		
SÜ 242 888	01.87 -	D2866TUH		1882 342 134	420 GF420X		
				1878 002 706	420 10 420GTZ		
				3151 000 395	KZIS-4		
SÜ 272 888	04.93 - 05.95	D2865LUH02		3482 085 034	420 MF420		
				1878 001 154 #	420 10 420WGTZ		
				3151 000 395	KZIS-4		
				3482 006 036 #	420 GTF420	je nach Ausführung, mit unterschiedlicher Kupplung / depending on version, with different clutch	(85)
				1878 001 154 #	420 10 420WGTZ	je nach Ausführung, mit unterschiedlicher Kupplung / depending on version, with different clutch	(85)
				3151 000 395	KZIS-4	je nach Ausführung, mit unterschiedlicher Kupplung / depending on version, with different clutch	(85)
				3482 083 032	430 MFZ430	Leistung [kW] / Engine Output [kW]: 191	(38)
				1878 080 031	430 10 430WGTZ	Leistung [kW] / Engine Output [kW]: 191	(38)
				3151 000 034	KZISZ-5	Leistung [kW] / Engine Output [kW]: 191	(38)
SÜ 280 789	01.82 - 12.92	D2566		3482 124 550	430 GMF430		
				3482 006 036 ●#	420 GTF420		
				1878 002 706	420 10 420GTZ		
				3151 000 395	KZIS-4	mit Dauerschmierung / with constant lubrication	(89)
				3151 000 512	KZIS-4	mit Schmierrohranschluß / with lubricating pipe coupling	(91)
SÜ 292 888 SÜ 322 888	04.92 - 04.93	D2866TOH/310, D2865LUH08		1882 342 135 #	420 GF420X	Getr. / GBox: ZF S6-90	
	05.95 - 06.97			1878 065 131 #	420 10 420WGTZ	Getr. / GBox: ZF S6-90	
				3151 000 395	KZIS-4	Getr. / GBox: ZF S6-90	
				1882 342 134	420 GF420X		
				1878 003 657	420 10 420WGTZ		
				3151 000 395	KZIS-4		

ÜL 09.89 -

ÜL 242 893 ÜL 272 893	- 06.91	D2865LUH		3482 083 032	430 MFZ430		
				1878 080 031	430 10 430WGTZ		
				3151 000 034	KZISZ-5		

		CODE				
---	--	------	--	---	---	---















MAN

ÜL 09.89 -						
ÜL 242 893	09.89 - 03.93	D2866LUH	 3482 124 550	430 GMF430	->06.1991 893	
			 3482 006 036 #	420 GTF420	->06.1991 893	
			 1878 001 154 #	420 10 420WGTZ	->06.1991 893	
			 3151 000 395	KZIS-4	->06.1991 893	
			 3482 085 034	420 MF420	07.1991-> 893	
			 1878 001 154 #	420 10 420WGTZ	07.1991-> 893	
			 3151 000 395	KZIS-4	07.1991-> 893	
ÜL 272 893	03.93 -	D2866LUH	 3482 085 034	420 MF420		
			 1878 001 154 #	420 10 420WGTZ		
			 3151 000 395	KZIS-4		
ÜL 272 893	03.93 -	D2865LUH05, D2865LUH02	 3482 083 032	430 MFZ430		
			 1878 080 031	430 10 430WGTZ		
			 3151 000 034	KZISZ-5		
ÜL 292 893	09.89 - 03.93	D2866TUH	 1882 342 134	420 GF420X	893	
			 1878 003 657	420 10 420WGTZ	893	
			 3151 000 395	KZIS-4	893	
ÜL 312,ÜL 322 893	04.92 - 09.96	D2865LUH	 1882 342 134	420 GF420X	893	
			 1878 003 657	420 10 420WGTZ	893	
			 3151 000 395	KZIS-4	893	
			 3482 083 032	430 MFZ430	893	
			 1878 080 031	430 10 430WGTZ	893	
			 3151 000 034	KZISZ-5	893	

















		CODE					
---	--	------	--	--	---	---	---

MAN

ÜL 09.89 -





















ÜL 313 A01 ÜL 353 A01	09.96 -	D2866LUH		3482 083 032	430 MFZ430		
	06.97 -			1878 085 641	430 10 430GTZ		
				3151 000 034	KZISZ-5		
				3482 083 032	430 MFZ430	für Fahrzeuge mit Retarder / for vehicles with retarder (75)	
				1878 080 031	430 10 430WGTZ	für Fahrzeuge mit Retarder / for vehicles with retarder (75)	
				3151 000 034	KZISZ-5	für Fahrzeuge mit Retarder / for vehicles with retarder (75)	
		D2866LOH28, D2866LUH25		3482 083 032	430 MFZ430	Getr. / GBox: S 6-1600 für OE-Nummer / for OE number 81.30305.0193 A01, A04 (83)	
				1878 080 034	430 10 430WGTZ	Getr. / GBox: S 6-1600 für OE-Nummer / for OE number 81.30301.0500 A01, A04 (83)	
				3151 000 034	KZISZ-5	Getr. / GBox: S 6-1600 für OE-Nummer / for OE number 81.30550.0094 A01, A04 (83)	
		D2866LUH24		3482 083 032	430 MFZ430	Getr. / GBox: S 6-1600 für OE-Nummer / for OE number 81.30305.0193 A01, A04 (83)	
				1878 080 033	430 10 430WGTZ	Getr. / GBox: S 6-1600 für OE-Nummer / for OE number 81.30301.0499 A01, A04 (83)	
				3151 000 034	KZISZ-5	Getr. / GBox: S 6-1600 für OE-Nummer / for OE number 81.30550.0094 A01, A04 (83)	
		D2866LUH30		3482 083 032	430 MFZ430	Getr. / GBox: 8 S-180 für OE-Nummer / for OE number 81.30305.0193 A04 (83)	
				1878 080 037	430 10 430WGTZ	Getr. / GBox: 8 S-180 für OE-Nummer / for OE number 81.30301.0503 A04 (83)	
				3151 000 034	KZISZ-5	Getr. / GBox: 8 S-180 für OE-Nummer / for OE number 81.30550.0094 A04 (83)	



10 ...











10.136 HOCL,HOCR 469 10.150 HOCL,HOCR 469 10.180 HOCL,HOCR 469				3482 060 132	350 MF350		
				1878 000 841 #	350 10 350WGTZ		
				3151 199 001	KZIS-3		
10.150 752		D0826OH		3482 060 132	350 MF350		
				1878 001 145	350 10 350WGTZ		
				3151 199 001	KZIS-3		
10.180 752		D0826TOH		3482 060 132	350 MF350		
				1878 001 145	350 10 350WGTZ		
				3151 199 001	KZIS-3		
10.180	01.87 - 12.92	D0826TOH		3400 125 501  3482 060 132  1878 001 077  3151 199 001	350 10 MF350 350GTZ KZIS-3		
10.190 752 10.220 752 10.230 752		D0826LOH		3482 060 132	350 MF350		
				1878 001 145	350 10 350WGTZ		
				3151 199 001	KZIS-3		

		CODE		 Parameter		
---	--	------	--	---	---	---

MAN

11 ...						
11.150 752		D0826OH	 3482 060 132	350 MF350		
			 1878 001 145	350 10 350WGTZ		
			 3151 199 001	KZIS-3		
11.150	01.93-	D0826OH	 3400 125 501  3482 060 132  1878 001 077  3151 199 001	350 10 MF350 350GTZ KZIS-3		
11.180 752		D0826TOH	 3482 060 132	350 MF350		
			 1878 001 145	350 10 350WGTZ		
			 3151 199 001	KZIS-3		
11.180	01.93-	D0826TOH	 3400 125 501  3482 060 132  1878 001 077  3151 199 001	350 10 MF350 350GTZ KZIS-3		
11.190 11.192 11.230 HOCL/R	01.93- 01.91 - 12.92 01.93-	D0826LOHO	 3400 125 501  3482 060 132  1878 001 077  3151 199 001	350 10 MF350 350GTZ KZIS-3		
11.192 HOCL,HOCLR 469			 3482 060 132	350 MF350		
			 1878 000 841 #	350 10 350WGTZ		
			 3151 199 001	KZIS-3		



































12 ...						
12.220 HOCL/R-SR A77	02.02-	D0836LOH	 3482 060 132	350 MF350	Getr. / GBox: ZF S6-36 Getr. / GBox: ZF 6S-890	
			 1878 000 841 #	350 10 350WGTZ	Getr. / GBox: ZF S6-36 Getr. / GBox: ZF 6S-890	
			 3151 199 001	KZIS-3	Getr. / GBox: ZF S6-36 Getr. / GBox: ZF 6S-890	

13 ...						
13.210 HOCL/R A53 13.230 HOCL/R A53	07.94- 07.94-	D0826LUH	 3482 060 132	350 MF350	Getr. / GBox: ZFS6-39, 6S-890	
			 1878 001 145	350 10 350WGTZ	->07.2001 Getr. / GBox: ZFS6-39, 6S-890	
			 1878 000 841 #	350 10 350WGTZ	08.2001-> Getr. / GBox: ZFS6-39, 6S-890	
			 3151 199 001	KZIS-3	Getr. / GBox: ZFS6-39, 6S-890	
13.220 HOCL/R A53	07.94-	D0826LOH, D0836LOH	 3482 060 132	350 MF350	Getr. / GBox: ZFS6-39, 6S-890	
			 1878 001 145	350 10 350WGTZ	->07.2001 Getr. / GBox: ZFS6-39, 6S-890	
			 1878 000 841 #	350 10 350WGTZ	08.2001-> Getr. / GBox: ZFS6-39, 6S-890	
			 3151 199 001	KZIS-3	Getr. / GBox: ZFS6-39, 6S-890	
13.220 HOCL-SKD A52	02.01-	D0826LOH15	 3482 060 132	350 MF350	Getr. / GBox: ZF S6-36, 6S-890	
			 1878 000 841 #	350 10 350WGTZ	Getr. / GBox: ZF S6-36, 6S-890	
			 3151 199 001	KZIS-3	Getr. / GBox: ZF S6-36, 6S-890	

14 ...						
14.280 HOCL/R A67 A83	04.01-	D0836LOH	 3482 083 032	430 MFZ430	Getr. / GBox: ZF S6-85 A67	
			 1878 080 031	430 10 430WGTZ	Getr. / GBox: ZF S6-85 A67	
			 3151 000 034	KZISZ-5	Getr. / GBox: ZF S6-85 A67	
		D0836LOH02	 3400 700 362	430 10	Getr. / GBox: ZF S6-1600 A83	























		CODE					
---	--	------	--	--	---	---	---











MAN

16 ...							
16.240 753		D2866OH		1882 342 134	420 GF420X		
				1878 003 657	420 10 420WGTZ		
				3151 000 395	KZIS-4		
16.240 HOC 471	01.79 - 08.96	D2866OH		1882 302 131	380 GF380	Getr. / GBox: ZF S6-80	
				1878 001 152	380 10 380WGTZ	Getr. / GBox: ZF S6-80	
				3151 000 395	KZIS-4	Getr. / GBox: ZF S6-80	
16.240 HOCL/R 470 16.280 HOCL/R 470	02.79 - 08.96	D2866OH		1882 302 131	380 GF380		
	02.79 - 08.96			1878 001 152	380 10 380WGTZ		
				3151 000 395	KZIS-4		
16.240 HOCL/R 754	04.89 -	D2866OH		3482 124 534	430 GMF430	->06.1995	
				1878 003 657	420 10 420WGTZ	->06.1995	
				3151 000 395	KZIS-4	->06.1995	
				3400 700 310  3482 078 133  1862 364 133  3151 000 034	400 10 MFZ400 400WGVZ KZISZ-5	07.1995-> Nabenprofil / Hub Profile: 1 3/4"-10N	(46)
16.280 HOC 471	01.79 - 08.96	D2866OH		1882 302 131	380 GF380	Getr. / GBox: ZF S6-80	
				1878 001 152	380 10 380WGTZ	Getr. / GBox: ZF S6-80	
				3151 000 395	KZIS-4	Getr. / GBox: ZF S6-80	
				3482 124 534	430 GMF430	Getr. / GBox: ZF S6-90	
				1878 003 657	420 10 420WGTZ	Getr. / GBox: ZF S6-90	
				3151 000 395	KZIS-4	Getr. / GBox: ZF S6-90	
16.290 753		D2866TOH		3482 083 032	430 MFZ430		
				1878 080 031	430 10 430WGTZ		
				3151 000 034	KZISZ-5		
16.290 HOC 471	01.79 - 08.96	D2866TOH		3482 124 534	430 GMF430	->07.1990	
				1882 342 134	420 GF420X	08.1990->	
				1878 003 657	420 10 420WGTZ		
				3151 000 395	KZIS-4		
16.290 HOCL/R 470	02.79 - 08.96	D2866TOH		3482 124 534	430 GMF430	->07.1990 Getr. / GBox: S 6-90	
				1882 301 239 ●	420 GF420	->07.1990 Getr. / GBox: S 6-90	
				1878 003 657	420 10 420WGTZ	->07.1990 Getr. / GBox: S 6-90	
				1882 342 134	420 GF420X	08.1990-> Getr. / GBox: S 6-90	
				1878 003 657	420 10 420WGTZ	08.1990-> Getr. / GBox: S 6-90	
				3151 000 395	KZIS-4	Getr. / GBox: S 6-90	

		CODE					
---	--	------	--	--	---	---	---

MAN



















16 ...							
16.290 HOCL/R 754	04.89-	D2866TOH		3482 124 516	430 GMF430	->06.1995	
				1882 342 134 ●	420 GF420X	->06.1995	
				1878 003 657	420 10 420WGTZ	->06.1995	
				3151 000 395	KZIS-4	->06.1995	
				3482 083 032	430 MFZ430	07.1995->	
				1878 080 031	430 10 430WGTZ	07.1995->	
				3151 000 034	KZISZ-5	07.1995->	
16.360 HOCL/R 470	02.79- 08.96	D2866LXOH		1882 342 134	420 GF420X	->07.1990 Getr. / GBox: S6-150	
				1861 911 232	420 10 420WGVZ	->07.1990 Getr. / GBox: S6-150	
				3151 000 395	KZIS-4	->07.1990 Getr. / GBox: S6-150	
				3482 124 549	430 GMF430	08.1990-> Getr. / GBox: S6-150	
				1882 342 135 ●#	420 GF420X	08.1990-> Getr. / GBox: S6-150	
				1878 086 741	420 10 430WGTZ	08.1990-> Getr. / GBox: S6-150	
				3151 000 395	KZIS-4	08.1990-> Getr. / GBox: S6-150	
16.370 HOCL/R 754	04.89 -	D2866LOH		3482 124 549	430 GMF430		
				1882 342 135 ●#	420 GF420X		
				1878 086 741	420 10 430WGTZ		
				3151 000 395	KZIS-4		
16.372 HOCL/R 470	02.79- 08.96	D2866LOH		3482 124 549	430 GMF430	Getr. / GBox: S6-150	
				1882 342 135 ●#	420 GF420X	Getr. / GBox: S6-150	
				1878 086 741	420 10 430WGTZ	Getr. / GBox: S6-150	
				3151 000 395	KZIS-4	Getr. / GBox: S6-150	

18 ...							
18.220 HOCL-SKD 18.230 HOCL-SKD 18.250 HOCL-SKD				3482 086 132	400 MFZ400X		
				1862 364 133	400 10 400WGVZ		
				3151 000 034	KZISZ-5		
18.310 HOCL/R A51 A82	01.92 -	D2866LOH		3400 700 362 ● 3482 083 032 ● 1878 080 033 ● 3151 000 034	430 10 MFZ430 430WGTZ KZISZ-5	Getr. / GBox: ZF S6-1600	
				3400 700 506 ●#	430 10	XTend Getr. / GBox: ZF S6-1600 Nabenprofil / Hub Profile: 41,1x50,8-10N (46) Nur zusammen verbauen / Only install together (51)	
				3482 083 032	430 MFZ430	Getr. / GBox: ZF S6-85 Getr. / GBox: ZF S6-1600	
				1878 080 031	430 10 430WGTZ	Getr. / GBox: ZF S6-85	
			3151 000 034	KZISZ-5	Getr. / GBox: ZF S6-85 Getr. / GBox: ZF S6-1600		
		D2876LOH03		3482 083 032	430 MFZ430	Getr. / GBox: G0-210	
				1878 080 037	430 10 430WGTZ	Getr. / GBox: G0-210	
				3151 000 335	KZIS-5	Getr. / GBox: G0-210	

		CODE					
---	--	------	--	--	---	---	---















































MAN

18 ...

18.310 HOCL/R-SKD A55	01.95-	D2866LOH	 3400 700 362 ⊗ 3482 083 032 ⊗ 1878 080 033 ⊙ 3151 000 034	430 10 MFZ430 430WGTZ KZISZ-5	Getr. / GBox: ZF S6-1600	
			 3400 700 506 ●■	430 10	XTend Getr. / GBox: ZF S6-1600 Nabenprofil / Hub Profile: 41,1x50,8-10N Nur zusammen verbauen / Only install together	(46) (51)
			 3482 083 032	430 MFZ430	Getr. / GBox: ZF S6-85 Getr. / GBox: ZF S6-1600	
			 1878 080 031	430 10 430WGTZ	Getr. / GBox: ZF S6-85	
			 3151 000 034	KZISZ-5	Getr. / GBox: ZF S6-85 Getr. / GBox: ZF S6-1600	
18.313 HOCL/R-SKD A55	01.95-	D2866LOH27	 3400 700 506 ●■	430 10	XTend Getr. / GBox: ZF S6-1600 Nabenprofil / Hub Profile: 41,1x50,8-10N Nur zusammen verbauen / Only install together	(46) (51)
			 3400 700 362 ⊗ 3482 083 032 ⊗ 1878 080 033 ⊙ 3151 000 034	430 10 MFZ430 430WGTZ KZISZ-5	Getr. / GBox: ZF S6-1600	
18.350 HOCL/R A51 A82 18.370 HOCL/R A51	01.92-	D2866LOH	 3400 700 506 ●■	430 10	XTend Getr. / GBox: ZF S6-1600 Nabenprofil / Hub Profile: 41,1x50,8-10N Nur zusammen verbauen / Only install together	(46) (51)
			 3400 700 362 ⊗ 3482 083 032 ⊗ 1878 080 033 ⊙ 3151 000 034	430 10 MFZ430 430WGTZ KZISZ-5	Getr. / GBox: ZF S6-1600	
	01.92-	D2876LOH03	 3482 083 032	430 MFZ430	Getr. / GBox: G0-210	
			 1878 080 037	430 10 430WGTZ	Getr. / GBox: G0-210	
18.350 HOCL/R-SKD A55	01.95-	D2866LOH26	 3400 122 301 ⊗ 3482 083 032 ⊗ 1878 080 034 ⊙ 3151 000 034	430 10 MFZ430 430WGTZ KZISZ-5	Getr. / GBox: ZF 8S-180	
			 3400 700 507 ●■	430 10	XTend Getr. / GBox: ZF 8S-180 Nabenprofil / Hub Profile: 41,1x50,8-10N Nur zusammen verbauen / Only install together	(46) (51)
			 3400 700 362 ⊗ 3482 083 032 ⊗ 1878 080 033 ⊙ 3151 000 034	430 10 MFZ430 430WGTZ KZISZ-5	Getr. / GBox: ZF S6-1600	
			 3400 700 506 ●■	430 10	XTend Getr. / GBox: ZF S6-1600 Nabenprofil / Hub Profile: 41,1x50,8-10N Nur zusammen verbauen / Only install together	(46) (51)
18.360 HOCL/R A82	06.02-	D2866LOH28, D2866LOH33	 3400 700 362 ⊗ 3482 083 032 ⊗ 1878 080 033 ⊙ 3151 000 034	430 10 MFZ430 430WGTZ KZISZ-5	Getr. / GBox: ZF S6-1600	
18.370 HOCL/R-SKD A55	01.95-	D2866LOH	 3400 700 507 ●■	430 10	XTend Getr. / GBox: ZF S6-180 Nabenprofil / Hub Profile: 41,1x50,8-10N Nur zusammen verbauen / Only install together	(46) (51)
			 3400 122 301 ⊗ 3482 083 032 ⊗ 1878 080 034 ⊙ 3151 000 034	430 10 MFZ430 430WGTZ KZISZ-5	Getr. / GBox: ZF S6-180	



		CODE				
---	--	------	--	---	---	---

MAN



18 ...							
18.400 HOCL/R A51 A82	01.92-	D2866LOH		3400 700 507 	430 10	XTend Getr. / GBox: ZF 8S-180 Nabenprofil / Hub Profile: 41,1x50,8-10N Nur zusammen verbauen / Only install together (46) (51)	
				3400 700 362  3482 083 032  1878 080 033  3151 000 034	430 10 MFZ430 430WGTZ KZISZ-5	Getr. / GBox: ZF S6-1600	
				3400 122 301  3482 083 032  1878 080 034  3151 000 034	430 10 MFZ430 430WGTZ KZISZ-5	Getr. / GBox: ZF 8S-180	
				D2876LOH03		3482 083 032 MFZ430	430
				1878 080 037 430WGTZ	430 10	Getr. / GBox: G0-210	
					3151 000 335 KZIZ-5	430	Getr. / GBox: G0-210
18.400 HOCL/R-SKD A55	01.95-	D2866LOH23		3400 700 507 	430 10	XTend Getr. / GBox: 8S-180 Nabenprofil / Hub Profile: 41,1x50,8-10N Nur zusammen verbauen / Only install together (46) (51)	
				3400 122 301  3482 083 032  1878 080 034  3151 000 034	430 10 MFZ430 430WGTZ KZISZ-5	Getr. / GBox: 8S-180	
18.410 HOCL/R A82	06.02-	D2866LOH34, D2866LOH29		3400 122 301  3482 083 032  1878 080 034  3151 000 034	430 10 MFZ430 430WGTZ KZISZ-5	Getr. / GBox: ZF 8S-180	
18.420 HOCL/R A51	01.92-	D2866LOH		3400 700 512 	430 10	XTend Getr. / GBox: ZF 8S-180 Nabenprofil / Hub Profile: 41,1x50,8-10N Nur zusammen verbauen / Only install together (46) (51)	
				3400 700 507 	430 10	XTend Getr. / GBox: ZF 8S-180 Nabenprofil / Hub Profile: 41,1x50,8-10N Nur zusammen verbauen / Only install together (46) (51)	
				3400 122 301  3482 083 032  1878 080 034  3151 000 034	430 10 MFZ430 430WGTZ KZISZ-5	Getr. / GBox: ZF 8S-180	
				D2876LOH03		3482 083 032 MFZ430	430
				1878 080 037 430WGTZ	430 10	Getr. / GBox: G0-210	
					3151 000 335 KZIZ-5	430	Getr. / GBox: G0-210
18.420 HOCL/R-SKD A55	01.95-	D2866LOH20		3400 700 507 	430 10	XTend Getr. / GBox: ZF 8S-180 Nabenprofil / Hub Profile: 41,1x50,8-10N Nur zusammen verbauen / Only install together (46) (51)	
				3400 122 301  3482 083 032  1878 080 034  3151 000 034	430 10 MFZ430 430WGTZ KZISZ-5	Getr. / GBox: ZF 8S-180	
18.460 HOCL/R A51	01.92-	D2876LOH		3482 083 032 MFZ430	430	Getr. / GBox: ZF 8S-180	
					1878 080 037 430WGTZ	430 10	Getr. / GBox: ZF 8S-180
					3151 000 034 KZISZ-5	430	Getr. / GBox: ZF 8S-180
					3400 700 505 	430 10	XTend Getr. / GBox: ZF 8S-180 Nabenprofil / Hub Profile: 41,1x50,8-10N Nur zusammen verbauen / Only install together (46) (51)
					3400 700 511 	430 10	XTend Getr. / GBox: ZF 8S-180 Nabenprofil / Hub Profile: 41,1x50,8-10N Nur zusammen verbauen / Only install together (46) (51)
					3482 083 032 MFZ430	430	Getr. / GBox: G0-210
					1878 080 037 430WGTZ	430 10	Getr. / GBox: G0-210
					3151 000 335 KZIZ-5	430	Getr. / GBox: G0-210

		CODE				
---	--	------	--	---	---	---



MAN

24 ...						
24.350 HOCLN A54	01.97 -	D2866LOH26		3400 700 507 ●■	430 10	XTend Getr. / GBox: ZF 8S-180 Nabenprofil / Hub Profile: 41,1x50,8-10N Nur zusammen verbauen / Only install together (46) (51)
				3400 122 301 ● 3482 083 032 ● 1878 080 034 ◆ 3151 000 034	430 10 MFZ430 430WGTZ KZISZ-5	Getr. / GBox: ZF 8S-180
24.400 HOCLN A54	01.97 -	D2866LOH23		3400 700 507 ●■	430 10	XTend Getr. / GBox: ZF 8S-180 Nabenprofil / Hub Profile: 41,1x50,8-10N Nur zusammen verbauen / Only install together (46) (51)
				3400 122 301 ● 3482 083 032 ● 1878 080 034 ◆ 3151 000 034	430 10 MFZ430 430WGTZ KZISZ-5	Getr. / GBox: ZF 8S-180

530						
530 HOR				1863 100 030	GR-3	mit Anlauftring / with thrust ring (88)







535						
535				1881 039 532 #	350 G350KR	Länderausführung: Türkei / Country Version: Turkey (41)
				1878 001 144	350 10 350WGTZ	Länderausführung: Türkei / Country Version: Turkey (41)
				1878 001 147 #	350 10 350WGTZ	Länderausführung: Türkei / Country Version: Turkey (41)
				3151 000 395	KZIS-4	Länderausführung: Türkei / Country Version: Turkey (41)
535 HO	-04.72			1881 039 532 #	350 G350KR	
				1878 001 074	350 10 350GTZ	
				1863 100 030	GR-3	mit Anlauftring / with thrust ring (88)
535 HO	05.72 -			1881 039 532 #	350 G350KR	
				1878 005 367	350 10 350WGTZ	
				1863 100 030	GR-3	mit Anlauftring / with thrust ring (88)



630						
630				1861 034 147 #	350 10 350	

750						
750 HO				1861 470 234	380 10 380GSZ	Getr. / GBox: S5-35
750 HO				3482 124 534	430 GMF430	
				1882 301 239 ●	420 GF420	
				1861 206 211 #	420 10 420GS	
				1863 009 100	GR-5	mit Anlauftring / with thrust ring (88)
750 HO,SÜ,R,Ü (Daimler Chrysler Motor) / 750 HO,SÜ,R,Ü (Daimler Chrysler Engine)				3482 124 541	430 GMF430	
				1882 330 032 ●#	420 GF420	
				1878 001 155 ▲#	420 10 420WGTZ	
				1863 009 100	GR-5	mit Anlauftring / with thrust ring (88)







		CODE					
---	--	------	--	--	---	---	---

MAN





750							
750 SL	09.72-			3482 124 534	430		
				1882 301 239 ●	420		
				1878 001 155 ▲#	420 10		
				1863 009 100	420WGZ GR-5	mit Anlauftring / with thrust ring	(88)
750 SL	-08.72			3482 124 534	430		
				1882 301 239 ●	420		
				1863 009 100	420 GR-5	mit Anlauftring / with thrust ring	(88)
750 SL				3151 000 395	KZIS-4		

890							
890 UG,UO				3482 124 534	430		
				1882 301 239 ●	420		
				1861 206 211 #	420 10		
				1863 009 100	420GS GR-5	mit Anlauftring / with thrust ring	(88)

MAZ

































Bus							
103-070		DCOM906		3482 083 032	430	Getr. / GBox: ZF 6S-85	
				1878 080 031	430 10	Getr. / GBox: ZF 6S-85	
				3151 000 157	MFZ430 430WGZ KZISZ-5	Getr. / GBox: ZF 6S-85	
		DeutzBF6M101 3EC		3482 083 032	430	Getr. / GBox: ZF 6S-85	
				1878 080 031	430 10	Getr. / GBox: ZF 6S-85	
				3151 000 157	430WGZ KZISZ-5	Getr. / GBox: ZF 6S-85	
152-050		MAND2866LOH		3482 083 032	430	Getr. / GBox: ZF 6S-1600	
				1878 080 031	430 10	Getr. / GBox: ZF 6S-1600	
				3151 000 157	430WGZ KZISZ-5	Getr. / GBox: ZF 6S-1600	

MERCEDES-BENZ

100 Bus (631) 02.88 - 02.96								
D D (631.333, 631.343, 631.334, 631.344), 53 kW D (631.333, 631.343, 631.334, 631.344), 55 kW	12.90 - 12.94	OM616.963, OM616		3000 424 002	228 23			
				3082 191 032 1862 375 031 3151 198 031	M228 228LPB KZIS-0			
	02.88 - 05.92	12.90 - 02.96			3074 600 205		->10.1991 Hüllenlänge [mm] / Sleeve Length [mm]: 980 Länge [mm] / Length [mm]: 1450	(27) (42)
					6283 600 113		Chass. 099541->	
				6284 600 111				

		CODE				
---	--	------	--	---	---	---

































MERCEDES-BENZ

SPRINTER 2-t Bus (901, 902) 01.95 - 05.06								
214	02.95 - 05.06	M111.979	 3000 826 901  3082 268 031  1878 994 001  3151 248 031	240 26 M240 240TB KZIS-0				
			 1863 869 010	35	Nadellager / Needle Bearing	(47)		
			 6283 600 115					
		 6284 600 573						
		M111.984	 3000 990 218 	240 26	XTend Kit plus CSC ->Chass. A920787 ->Chass. R636764 Nabenprofil / Hub Profile: 26,5x29-26N für Schwungradtiefe [mm] / for flywheel depth [mm]: 8	(46) (84)		
			 3000 990 252 	240 26	XTend Kit plus CSC Nabenprofil / Hub Profile: 26,5x29-26N für Schwungradtiefe [mm] / for flywheel depth [mm]: 12 Nur zusammen verbauen / Only install together	(46) (84) (51)		
 3182 997 804 	HHAS-1		Immer erneuern / Renew everytime	(28)				
 3182 997 802	HHAS-1		Schaltgetriebe sequentiell / Sequential Manual Transmission mit Sensor / with sensor Füllmedium: Mineralöl / Fill Medium: Mineral Oil Immer erneuern / Renew everytime	(54) (92) (24) (28)				
214 NGT	04.00 - 05.06	M111.984	 3000 990 218 	240 26	XTend Kit plus CSC ->Chass. A920787 ->Chass. R636764 Nabenprofil / Hub Profile: 26,5x29-26N für Schwungradtiefe [mm] / for flywheel depth [mm]: 8	(46) (84)		
			 3000 990 252 	240 26	XTend Kit plus CSC Nabenprofil / Hub Profile: 26,5x29-26N für Schwungradtiefe [mm] / for flywheel depth [mm]: 12 Nur zusammen verbauen / Only install together	(46) (84) (51)		
			 3182 997 804 	HHAS-1	Immer erneuern / Renew everytime	(28)		
			 3182 997 802	HHAS-1	Schaltgetriebe sequentiell / Sequential Manual Transmission mit Sensor / with sensor Füllmedium: Mineralöl / Fill Medium: Mineral Oil Immer erneuern / Renew everytime	(54) (92) (24) (28)		
208 CDI 211 CDI 213 CDI 216 CDI	04.00 - 05.06	OM611.981/987, OM612.981	 2290 601 011 	240 26	ZMS Modul XTend plus CSC Montageart: nicht vormontiert / Mounting Type: not pre-mounted Beinhaltet ZMS, Kupplungsdruckplatte, Kupplungsscheibe und CSC / Contains twin-mass flywheel, clutch cover assembly, clutch disc and CSC enthält Schwungradbefestigungsschrauben / includes bolt for flywheel mounting	(43) (16) (65)		
			 3000 990 218 	240 26	XTend Kit plus CSC ->Chass. A920787 ->Chass. R636764 Nabenprofil / Hub Profile: 26,5x29-26N für Schwungradtiefe [mm] / for flywheel depth [mm]: 8	(46) (84)		
			 3000 990 252 	240 26	XTend Kit plus CSC Nabenprofil / Hub Profile: 26,5x29-26N für Schwungradtiefe [mm] / for flywheel depth [mm]: 12 Nur zusammen verbauen / Only install together	(46) (84) (51)		
			 3182 997 802	HHAS-1	Schaltgetriebe sequentiell / Sequential Manual Transmission mit Sensor / with sensor Füllmedium: Mineralöl / Fill Medium: Mineral Oil Immer erneuern / Renew everytime	(54) (92) (24) (28)		
			 3182 997 804 	HHAS-1	Immer erneuern / Renew everytime	(28)		
			 1863 869 012	28	Nadellager / Needle Bearing	(47)		
			 6284 600 573					
		OM611.987, OM611.981, OM612.981						

















		CODE				
---	--	------	--	---	---	---

MERCEDES-BENZ

SPRINTER 2-t Bus (901, 902) 01.95 - 05.06





























208 D	02.95 - 04.00	OM601.943	 2290 601 007  2294 000 767  3082 267 233  1864 503 231  3151 248 031  1874 000 006	228 26 M228X 228B KZIS-0	ZMS Modul Montageart: nicht vormontiert / Mounting Type: not pre-mounted Beinhaltet ZMS, Kupplungsdruckplatte, Kupplungsscheibe und Ausrücker / Contains twin-mass flywheel, clutch cover assembly, clutch disc and releaser enthält Schwungradbefestigungsschrauben / includes bolt for flywheel mounting	(43) (15) (65)
			 3000 726 001  3082 267 233  1864 503 231  3151 248 031	228 26 M228X 228B KZIS-0		
			 1863 869 010	35	Nadellager / Needle Bearing	(47)
			 6283 600 115			
210 D	03.97 - 04.00	OM602LA	 3000 951 785  3082 269 031  1878 600 501  3151 248 031	250 26 M250 250CD KZIS-0		
			 3000 725 001 ●  3082 269 031  1864 504 031  3151 248 031	250 26 M250 250B KZIS-0		
			 2294 000 525	250 250		
		OM602.980	 1863 869 010	35	Nadellager / Needle Bearing	(47)
			 6283 600 115			
212 D	02.95 - 04.00	OM602LA	 3000 951 785  3082 269 031  1878 600 501  3151 248 031	250 26 M250 250CD KZIS-0		
			 3000 725 001 ●  3082 269 031  1864 504 031  3151 248 031	250 26 M250 250B KZIS-0		
			 2294 000 525	250 250		
		OM602.980	 1863 869 010	35	Nadellager / Needle Bearing	(47)

SPRINTER 3-t Bus (903) 01.95 - 05.06

314 314 4x4	02.95 - 05.06	M111.979	 3000 826 901  3082 268 031  1878 994 001  3151 248 031	240 26 M240 240TB KZIS-0		
			 1863 869 010	35	Nadellager / Needle Bearing	(47)
	08.02 - 05.06	M111.984	 3000 990 218  	240 26	XTend Kit plus CSC ->Chass. A920787 ->Chass. R636764 Nabenprofil / Hub Profile: 26,5x29-26N für Schwungradtiefe [mm] / for flywheel depth [mm]: 8	(46) (84)
			 3000 990 252  	240 26	XTend Kit plus CSC Nabenprofil / Hub Profile: 26,5x29-26N für Schwungradtiefe [mm] / for flywheel depth [mm]: 12 Nur zusammen verbauen / Only install together	(46) (84) (51)
			 3182 997 804 	HHAS-1	Immer erneuern / Renew everytime	(28)
			 3182 997 802	HHAS-1	Schaltgetriebe sequentiell / Sequential Manual Transmission mit Sensor / with sensor Füllmedium: Mineralöl / Fill Medium: Mineral Oil Immer erneuern / Renew everytime	(54) (92) (24) (28)
			 6283 600 115			
			 6284 600 573			

		CODE				
---	--	------	--	---	---	---



























MERCEDES-BENZ

SPRINTER 3-t Bus (903) 01.95 - 05.06								
314 NGT	04.00 - 05.06	M111.984	 3000 990 218  240 26	XTend Kit plus CSC ->Chass. A920787 ->Chass. R636764 Nabenprofil / Hub Profile: 26,5x29-26N (46) für Schwungradtiefe [mm] / for flywheel depth [mm]: 8 (84)				
			 3000 990 252  240 26	XTend Kit plus CSC Nabenprofil / Hub Profile: 26,5x29-26N (46) für Schwungradtiefe [mm] / for flywheel depth [mm]: 12 (84) Nur zusammen verbauen / Only install together (51)				
			 3182 997 804 	HHAS-1 Immer erneuern / Renew everytime (28)				
			 3182 997 802	HHAS-1 Schaltgetriebe sequentiell / Sequential Manual Transmission (54) mit Sensor / with sensor (92) Füllmedium: Mineralöl / Fill Medium: Mineral Oil (24) Immer erneuern / Renew everytime (28)				
			 6284 600 573					
308 D	02.95 - 04.00	OM601.943	 2290 601 007 ⚙️ 2294 000 767 ⚙️ 3082 267 233 ⚙️ 1864 503 231 ⚙️ 3151 248 031 ⚙️ 1874 000 006	228 26 M228X 228B KZIS-0	ZMS Modul Montageart: nicht vormontiert / Mounting Type: not pre-mounted (43) Beinhaltet ZMS, Kupplungsdruckplatte, Kupplungsscheibe und Ausrücker / Contains twin-mass flywheel, clutch cover assembly, clutch disc and releaser (15) enthält Schwungradbefestigungsschrauben / includes bolt for flywheel mounting (65)			
			 3000 726 001 ⚙️ 3082 267 233 ⚙️ 1864 503 231 ⚙️ 3151 248 031	228 26 M228X 228B KZIS-0				
			 1863 869 010	35	Nadellager / Needle Bearing (47)			
			 6283 600 115					
308 CDI 311 CDI 311 CDI 4x4 313 CDI 313 CDI 4x4 316 CDI 316 CDI 4x4	04.00 - 05.06 04.00 - 05.06 08.02 - 05.06 04.00 - 05.06 08.02 - 05.06 04.00 - 05.06 08.02 - 05.06	OM611.981/987, OM612.981 OM611.987, OM611.981, OM612.981	 2290 601 011  240 26	ZMS Modul XTend plus CSC Montageart: nicht vormontiert / Mounting Type: not pre-mounted (43) Beinhaltet ZMS, Kupplungsdruckplatte, Kupplungsscheibe und CSC / Contains twin-mass flywheel, clutch cover assembly, clutch disc and CSC (16) enthält Schwungradbefestigungsschrauben / includes bolt for flywheel mounting (65)				
			 3000 990 218  240 26	XTend Kit plus CSC ->Chass. A920787 ->Chass. R636764 Nabenprofil / Hub Profile: 26,5x29-26N (46) für Schwungradtiefe [mm] / for flywheel depth [mm]: 8 (84)				
			 3000 990 252  240 26	XTend Kit plus CSC Nabenprofil / Hub Profile: 26,5x29-26N (46) für Schwungradtiefe [mm] / for flywheel depth [mm]: 12 (84) Nur zusammen verbauen / Only install together (51)				
			 3182 997 802	HHAS-1 Schaltgetriebe sequentiell / Sequential Manual Transmission (54) mit Sensor / with sensor (92) Füllmedium: Mineralöl / Fill Medium: Mineral Oil (24) Immer erneuern / Renew everytime (28)				
			 3182 997 804 	HHAS-1 Immer erneuern / Renew everytime (28)				
			 1863 869 012	28	Nadellager / Needle Bearing (47)			
			 6284 600 573					
			310 D 4x4 312 D 2.9 312 D 2.9 4x4	05.97 - 08.02 02.95 - 04.00 05.97 - 08.02	OM602LA	 3000 951 785 ⚙️ 3082 269 031 ⚙️ 1878 600 501 ⚙️ 3151 248 031	250 26 M250 250CD KZIS-0	
						 3000 725 001 ● ⚙️ 3082 269 031 ⚙️ 1864 504 031 ⚙️ 3151 248 031	250 26 M250 250B KZIS-0	
						 2294 000 525	250 250	
 1863 869 010	35	Nadellager / Needle Bearing (47)						
 6283 600 115								





































		CODE				
---	--	------	--	---	---	---

MERCEDES-BENZ

SPRINTER 3-t Bus (906) 06.06 -

216 (906.713)	09.08-	M271.951	  	3000 990 144   3000 951 188  3182 997 804	240 26 HHAS-1	XTend Kit plus CSC Nabenprofil / Hub Profile: 26x29-26N	(46)
				6284 605 004			
210 CDI (906.711, 906.713)	03.09-	OM651.955	 	3000 990 287   2294 000 994	240 240	XTend Kit plus CSC enthält Schwungradbefestigungsschrauben / includes bolt for flywheel mounting	(65)
				6284 605 004			
211 CDI (906.711, 906.713) 215 CDI (906.711, 906.713)	06.06- 06.06-	OM646.990, OM646.989, OM646.985	  	2290 601 018   3000 951 188  2294 000 835  3182 997 804  1874 000 006	240 26 HHAS-1	ZMS Modul XTend plus CSC Montageart: nicht vormontiert / Mounting Type: not pre-mounted Beinhaltet ZMS, Kupplungsdruckplatte, Kupplungsscheibe und CSC / Contains twin-mass flywheel, clutch cover assembly, clutch disc and CSC enthält Schwungradbefestigungsschrauben / includes bolt for flywheel mounting	(43) (16) (65)
			  	3000 990 144   3000 951 188  3182 997 804	240 26 HHAS-1	XTend Kit plus CSC Nabenprofil / Hub Profile: 26x29-26N	(46)
				6284 605 004			

































SPRINTER 3,5-t Bus (906) 06.06 -

316 (906.733, 906.735) 316 NGT (906.733, 906.735)	09.08- 09.08-	M271.951	 	3000 990 144   3000 951 188  3182 997 804	240 26 HHAS-1	XTend Kit plus CSC Nabenprofil / Hub Profile: 26x29-26N	(46)
				6284 605 004			
310 CDI (906.731, 906.733, 906.735) 311 CDI (906.731, 906.733, 906.735) 311 CDI 4x4 (906.731, 906.733, 906.735) 313 CDI (906.731, 906.733, 906.735) 313 CDI 4x4 (906.731, 906.733, 906.735) 315 CDI (906.731, 906.733, 906.735) 315 CDI 4x4 (906.731, 906.733, 906.735)	03.09- 06.06- 02.08- 08.11- 08.11- 06.06- 02.08-	OM646 OM651	      	2290 601 018   3000 951 188  2294 000 835  3182 997 804  1874 000 006	240 26 HHAS-1	ZMS Modul XTend plus CSC Montageart: nicht vormontiert / Mounting Type: not pre-mounted Beinhaltet ZMS, Kupplungsdruckplatte, Kupplungsscheibe und CSC / Contains twin-mass flywheel, clutch cover assembly, clutch disc and CSC enthält Schwungradbefestigungsschrauben / includes bolt for flywheel mounting	(43) (16) (65)
			  	3000 990 144   3000 951 188  3182 997 804	240 26 HHAS-1	XTend Kit plus CSC Nabenprofil / Hub Profile: 26x29-26N	(46)
				6284 605 004			
318 CDI (906.731, 906.733, 906.735) 318 CDI 4x4 (906.731, 906.733, 906.735) 319 CDI / BlueTEC (906.731, 906.733, 906.735) 319 CDI / BlueTEC 4x4 (906.731, 906.733, 906.735)	02.08- 02.08- 03.09- 03.09-	OM642.993, OM642.896, OM642.992, OM642.898 OM642.896, OM642.992, OM642.898	   	3000 990 195   3000 951 824  3182 997 804	260 26 HHAS-1	XTend Kit plus CSC	
				6284 605 004			
				3000 990 195   3000 951 824  3182 997 804	260 26 HHAS-1	XTend Kit plus CSC	

		CODE				
---	--	------	--	---	---	---

MERCEDES-BENZ

SPRINTER 4-t Bus (904) 02.96 - 05.06

414	02.96 - 05.06	M111.979		3000 826 901  3082 268 031  1878 994 001  3151 248 031	240 26 M240 240TB KZIS-0			
				3000 951 785  3082 269 031  1878 600 501  3151 248 031	250 26 M250 250CD KZIS-0	für / for: SA 504097/03 für / for: SA 504096/03 für Motoren ohne Zweimassenschwungrad / for engines without dual-mass flywheel	(68) (68) (81)	
				1863 869 010	35	Nadellager / Needle Bearing	(47)	
				6283 600 115				
			M111.984		3000 990 218  	240 26	XTend Kit plus CSC ->Chass. A920787 ->Chass. R636764 Nabenprofil / Hub Profile: 26,5x29-26N für Schwungradtiefe [mm] / for flywheel depth [mm]: 8	(46) (84)
					3000 990 252  	240 26	XTend Kit plus CSC Nabenprofil / Hub Profile: 26,5x29-26N für Schwungradtiefe [mm] / for flywheel depth [mm]: 12 Nur zusammen verbauen / Only install together	(46) (84) (51)
					3182 997 804 	HHAS-1	Immer erneuern / Renew everytime	(28)
					3182 997 802	HHAS-1	Schaltgetriebe sequentiell / Sequential Manual Transmission mit Sensor / with sensor Füllmedium: Mineralöl / Fill Medium: Mineral Oil Immer erneuern / Renew everytime	(54) (92) (24) (28)
	408 CDI 411 CDI 413 CDI 416 CDI	04.00 - 05.06	OM611.981/987,		2290 601 011  	240 26	ZMS Modul XTend plus CSC Montageart: nicht vormontiert / Mounting Type: not pre-mounted Beinhaltet ZMS, Kupplungsdruckplatte, Kupplungsscheibe und CSC / Contains twin-mass flywheel, clutch cover assembly, clutch disc and CSC enthält Schwungradbefestigungsschrauben / includes bolt for flywheel mounting	(43) (16) (65)
		04.00 - 05.06	OM612.981		3000 990 218  	240 26	XTend Kit plus CSC ->Chass. A920787 ->Chass. R636764 Nabenprofil / Hub Profile: 26,5x29-26N für Schwungradtiefe [mm] / for flywheel depth [mm]: 8	(46) (84)
04.00 - 05.06				3000 990 252  	240 26	XTend Kit plus CSC Nabenprofil / Hub Profile: 26,5x29-26N für Schwungradtiefe [mm] / for flywheel depth [mm]: 12 Nur zusammen verbauen / Only install together	(46) (84) (51)	
04.00 - 05.06				3182 997 802	HHAS-1	Schaltgetriebe sequentiell / Sequential Manual Transmission mit Sensor / with sensor Füllmedium: Mineralöl / Fill Medium: Mineral Oil Immer erneuern / Renew everytime	(54) (92) (24) (28)	
					3182 997 804 	HHAS-1	Immer erneuern / Renew everytime	(28)
					1863 869 012	28	Nadellager / Needle Bearing	(47)

T2/LN1 Bus 07.87 - 12.92

O 609 D (672.072, 672.073)	07.87 - 12.92	OM364		3482 054 131	280 MFZ280	672.072-073	
				1861 919 134	280 10 280GTZ	672.072-073	
				3151 170 131	KZIZ-3	672.072-073	
O 611 D (672.372, 672.373)	07.87 - 12.92	OM364		3482 055 132	310 MFZ310	672.372-373	
				1861 303 248	310 10 310GSB	672.372-373	
				3151 170 131	KZIZ-3	672.372-373	

















		CODE				
---	--	------	--	---	---	---

MERCEDES-BENZ

T2/LN1 Bus 07.87 - 12.92

































O 614 D (672.375, 672.376)	07.87 - 12.92	OM354, OM364		3482 055 132	310 MFZ310	670.313	
				1861 303 248	310 10 310GSB	670.313	
				3151 170 131	KZIZ-3	670.313	
		OM364		3482 055 132	310 MFZ310	672.375-376	
				1861 303 248	310 10 310GSB	672.375-376	
				3151 170 131	KZIZ-3	672.375-376	

VITO Bus (W639) 09.03 -

109 CDI, 70 kW 109 CDI 4x4	09.06 - 09.07 -	OM646DE22LA		3000 951 111 	230 26	XTend 639.701/703/705/711/713 Nabenprofil / Hub Profile: 26,56x28,9-26N	(46)
				2294 000 834	240	639.701/703/705/711/713 enthält Schwungradbefestigungsschrauben / includes bolt for flywheel mounting	(65)
				3182 997 804 	HHAS-1	639.701/703/705/711/713 Immer erneuern / Renew everytime	(28)
109 CDI, 65 kW	09.03 -	OM646DE22LA		3000 951 111 	230 26	XTend 639.701/703/705 Nabenprofil / Hub Profile: 26,56x28,9-26N	(46)
				2294 000 834	240	639.701/703/705 enthält Schwungradbefestigungsschrauben / includes bolt for flywheel mounting	(65)
				3182 997 804 	HHAS-1	Getr. / GBox: 716.652 (SG-S370) Getr. / GBox: 716.680 (TSG-360) 639.701/703/705 Immer erneuern / Renew everytime	(28)
			3182 997 803	HHAS-1	Getr. Nr. / GBox No.: ->011 088 ->10.2003 Getr. / GBox: 716.637 (SG-S250) 639.701/703/705 Immer erneuern / Renew everytime	(28)	
			3182 997 804 	HHAS-1	Getr. Nr. / GBox No.: 011 088->10.2003-> Getr. / GBox: 716.637 (SG-S250) 639.701/703/705 Immer erneuern / Renew everytime	(28)	
110 CDI	09.10 -	OM651.940		3000 990 287 	240	XTend Kit plus CSC	
				2294 000 994	240 240	enthält Schwungradbefestigungsschrauben / includes bolt for flywheel mounting	(65)
				6284 605 008			









		CODE				
---	--	------	--	---	---	---









MERCEDES-BENZ







VITO Bus (W639)		09.03 -					
111 CDI, 80 kW	09.03-	OM646DE22LA		3000 951 111 	230 26	XTend ->Chass. 152223 ->05.2005 Getr. / GBox: 716.637 (SG-S250) 639.701/703/705/711/713 Nabenprofil / Hub Profile: 26,56x28,9-26N	(46)
				3000 951 112 	240 26	XTend ->Chass. 152223 ->05.2005 Getr. / GBox: 716.652 (SG-S370) 639.701/703/705/711/713 Nabenprofil / Hub Profile: 26,6x28,9-26N	(46)
				3000 951 112 	240 26	XTend Chass. 152224-> 05.2005-> 639.701/703/705/711/713 Nabenprofil / Hub Profile: 26,6x28,9-26N	(46)
				2294 000 834	240	639.701/703/705/711/713 enthält Schwungradbefestigungsschrauben / includes bolt for flywheel mounting	(65)
				3182 997 804 	HHAS-1	Getr. / GBox: 716.652 (SG-S370) Getr. / GBox: 716.680 (TSG-360) 639.701/703/705/711/713 Immer erneuern / Renew everytime	(28)
				3182 997 803	HHAS-1	Getr. Nr. / GBox No.: ->011 088 ->10.2003 Getr. / GBox: 716.637 (SG-S250) 639.701/703/705/711/713 Immer erneuern / Renew everytime	(28)
				3182 997 804 	HHAS-1	Getr. Nr. / GBox No.: 011 089-> 10.2003-> Getr. / GBox: 716.637 (SG-S250) 639.701/703/705/711/713 Immer erneuern / Renew everytime	(28)
		OM646.982		6284 605 008			
111 CDI 4x4 111 CDI, 85 kW	09.07 - 09.07 -	OM646DE22LA		3000 951 112 	240 26	XTend 639.701/703/705/711/713 Nabenprofil / Hub Profile: 26,6x28,9-26N	(46)
				2294 000 834	240	639.701/703/705/711/713 enthält Schwungradbefestigungsschrauben / includes bolt for flywheel mounting	(65)
				3182 997 804 	HHAS-1	639.701/703/705/711/713 Immer erneuern / Renew everytime	(28)
		OM646.982		6284 605 008			
113 CDI 116 CDI	09.10 - 09.10 -	OM651.940		3000 990 287 	240	XTend Kit plus CSC	
				6284 605 008			
		OM651DE22LA		2294 000 994	240 240	639.701/703/705/711/713 enthält Schwungradbefestigungsschrauben / includes bolt for flywheel mounting	(65)
115 CDI 115 CDI 4x4	09.03 - 09.07 -	OM646DE22LA		3000 951 112 	240 26	XTend 639.701/703/705/711/713 Nabenprofil / Hub Profile: 26,6x28,9-26N	(46)
				2294 000 834	240	639.701/703/705/711/713 enthält Schwungradbefestigungsschrauben / includes bolt for flywheel mounting	(65)
				3182 997 804 	HHAS-1	Getr. / GBox: 716.652 (SG-S370) Getr. / GBox: 716.680 (TSG-370) 639.701/703/705/711/713 Immer erneuern / Renew everytime	(28)
				3182 997 803	HHAS-1	Getr. Nr. / GBox No.: ->011 088 ->10.2003 Getr. / GBox: 716.637 (SG-S250) 639.701/703/705/711/713 Immer erneuern / Renew everytime	(28)
				3182 997 804 	HHAS-1	Getr. Nr. / GBox No.: 011 089-> 10.2003-> Getr. / GBox: 716.637 (SG-S250) 639.701/703/705/711/713 Immer erneuern / Renew everytime	(28)
		OM646.982		6284 605 008			

		CODE				
---	--	------	--	---	---	---

MERCEDES-BENZ











Fahrgestell / Chassis						
O 500 M 382.175/176 382.186 1725 382.186 1728 382.175 1732 382.176				3482 081 231	430 MFZ430	
				1878 080 033	430 10 430WGTZ	
				3151 000 497	KZISZ-5	
				3151 000 529	KZIS-4	
O 500 R 634.001 1632 634.001		OM926LA		3482 081 231	430 MFZ430	
				1878 080 033	430 10 430WGTZ	
				3151 000 497	KZISZ-5	
				3151 000 529	KZIS-4	
O 500 RS / 1836 634.011 O 500 RS / 2036 634.061 O 500 RS / 2242 634.071				3483 030 032 ⊕	430 MFZ430	
				1878 634 027	430 10 430WGTZ	je nach Ausführung, mit unterschiedlicher Kupplung / depending on version, with different clutch (85)
				1878 080 037	430 10 430WGTZ	je nach Ausführung, mit unterschiedlicher Kupplung / depending on version, with different clutch (85)

VARIO Bus 09.96 -							
O 812 (670.373, 670.674) O 814 (670.373, 670.374)	09.96 - 09.96 -	OM602LADE		3000 725 001	250 26 M250 250B KZIS-0		
				3000 951 785 ●	250 26 M250 250CD KZIS-0		
				2294 000 525	250 250		
			OM904LA		3400 127 701 ☾	362 18 MF362 362WGTTB	
					3400 700 484 ☾	362 10 MF362 362WGTTB	
					3151 000 396	KZIS-4	
O 815 (670.373, 670.374)	09.96 -	OM904.923		3400 127 701 ☾	362 18 MF362 362WGTTB	für / for: Medio 815 (68)	
				3151 000 396	KZIS-4	für / for: Medio 815 (68)	

811						
LPO 811 318.065-067	10.69 - 02.73	OM352		1882 317 131	280 HVB280	Mot. 393781-> 318.065-067
				1861 919 134	280 10 280GTZ	Mot. 393781-> 318.065-067
				3151 095 043	KZI-3	->Chass. 4282707 Mot. 393781-> 318.065-067
				3151 033 031	KZI-3	Chass. 4282708 - Mot. 678174 318.065-067
				3151 044 031	KZI-3	Mot. 678175-> 318.065-067
				1882 252 331	310 GFX310	->Chass. 922885 318.065-067
				1882 305 131	310 GFX310	Chass. 922886 - Mot. 393780 318.065-067
				1861 303 248	310 10 310GSB	->Mot. 393780 318.065-067
				3151 095 043	KZI-3	Chass. 922886 - Mot. 393780 318.065-067



















		CODE				
---	--	------	--	---	---	---

MERCEDES-BENZ

813						
LPO 813 318.065-067	10.69-	OM352		1882 317 131	280 HVB280	Mot. 393781-> 318.065-067
				1861 919 134	280 10 280GTZ	Mot. 393781-> 318.065-067
				3151 095 043	KZI-3	->Chass. 4282707 Mot. 393781-> 318.065-067
				3151 033 031	KZI-3	Chass. 4282708 - Mot. 678174 318.065-067
				3151 044 031	KZI-3	Mot. 678175-> 318.065-067
				1882 252 331	310 GFX310	->Chass. 922885 318.065-067
				1882 305 131	310 GFX310	Chass. 922886 - Mot. 393780 318.065-067
				1861 303 248	310 10 310GSB	->Mot. 393780 318.065-067
				3151 095 043	KZI-3	Chass. 922886 - Mot. 393780 318.065-067
			O 301 09.85 - 12.87			
O 301 697.001	06.86-05.87	OM366		3400 122 401 3482 008 038 1861 964 034 3151 044 031	310 10 MF310 310WGSZ KZI-3	697.001
O 301 697.006	02.86-05.87	OM366A		3482 012 240	330 GMF330	697.006
				1861 963 033	330 10 330WGSZ	697.006
				3151 044 031	KZI-3	697.006











		CODE				
---	--	------	--	---	---	---

MERCEDES-BENZ

O 302		01.64 - 11.75					
O 302 NKWID gekurzt 302.250 302.274 302.255 302.224 302.269 302.248 302.276 302.236 302.242 302.286 302.295 302.298 302.208 302.225 302.234 302.238 302.251 302.272 302.280 302.293 302.240 302.262 302.245 302.261 302.299 302.216 302.215 302.244 302.291 302.220 302.222 302.231 302.235 302.256 302.290 302.264 302.211 302.243 302.246 302.252 302.254 302.281 302.284 302.297 302.203 302.212 302.219	OM352		1882 201 132	295 GF295	302.280-281/284-285/290-291/295/264-265/268 /269-270-271/274-275/221/224-225/230-231/234 /235/240-241/244-245/250-251/254-255/261/201 /203/206/208/211/214-215/220		
		1861 279 133	295 10 295GTZ	302.221/224-225/230-231/234-235/240-241/244 /245/250-251/254-255/261/201/203/206/208/211 /214-215/220/280-281/284-285/290-291/295/264 /265/268-269-270-271/274-275			
		3151 095 043	KZI-3	302.221/224-225/230-231/234-235/240-241/244 /245/250-251/254-255/261/201/203/206/208/211 /214-215/220/280-281/284-285/290-291/295/264 /265/268-269-270-271/274-275			
		1882 252 331	310 GFX310	Chass. 005442 - Chass. 025406 302.280-281/284-285/290-291/295/264-265/268 /269-270-271/274-275/221/224-225/230-231/234 /235/240-241/244-245/250-251/254-255/261/201 /203/206/208/211/214-215/220			
		1882 305 131	310 GFX310	Chass. 025407-> 302.221/224-225/230-231/234-235/240-241/244 /245/250-251/254-255/261/201/203/206/208/211 /214-215/220/280-281/284-285/290-291/295/264 /265/268-269-270-271/274-275			
		1861 303 248	310 10 310GSB	Chass. 005442-> 302.221/224-225/230-231/234-235/240-241/244 /245/250-251/254-255/261/201/203/206/208/211 /214-215/220/280-281/284-285/290-291/295/264 /265/268-269-270-271/274-275			
		3151 095 043	KZI-3	Chass. 005442-> 302.221/224-225/230-231/234-235/240-241/244 /245/250-251/254-255/261/201/203/206/208/211 /214-215/220/280-281/284-285/290-291/295/264 /265/268-269-270-271/274-275			
		OM360		1882 234 433	350 GF350	Chass. 002235-> 302.233/236/242-243/246/252/256/262/272/276 /282-283/202/207/212-213/216/222/226/232/286 /292-293/296/298-299	
				1878 001 074	350 10 350GTZ	302.233/236/242-243/246/252/256/262/272/276 /282-283/202/207/212-213/216/222/226/232/286 /292-293/296/298-299	
				3151 094 041	KZI-4	302.233/236/242-243/246/252/256/262/272/276 /282-283/202/207/212-213/216/222/226/232/286 /292-293/296/298-299	
				1882 234 433	350 GF350	Chass. 797910-> 302.230-231/234-235/240-241/244-245/250-251 /254-255/261/201/203/206/208/220-221/224-225 /285/290-291/294-295/264-265/270/274-275/280 /281/284 Sonderausführung / Special design	(56)
				1878 001 074	350 10 350GTZ	302.240-241/244-245/261/264-265/280-281/284 /285/291/294-295/211/214-215/225/230-231/234 /235/290/270/274-275/250-251/254-255/201/203 /206/208/220-221/224 Sonderausführung / Special design	(56)
				3151 094 041	KZI-4	302.230-231/234-235/240-241/244-245/250-251 /254-255/261/201/203/206/208/220-221/224-225 /264-265/280-281/284-285/291/294-295/211/214 /215/290/270/274-275 Sonderausführung / Special design	(56)
		OM327		1882 234 433	350 GF350		
				1878 001 074	350 10 350GTZ		
				3151 094 041	KZI-4		
				1882 234 433	350 GF350	Sonderausführung / Special design	(56)
				1878 001 074	350 10 350GTZ	Sonderausführung / Special design	(56)
				3151 094 041	KZI-4	Sonderausführung / Special design	(56)





















		CODE					
---	--	------	--	--	---	---	---

MERCEDES-BENZ

O 302		01.64 - 11.75						
O 302 302.234 302.285 302.221 302.225 302.230 302.294 302.251 302.271 302.281 302.240 302.290 302.295 302.244/245 302.268 302.235 302.280 302.284 302.231 302.241 302.265 302.255 302.261	11.64 - 11.75	OM352.993, OM352.980		1882 201 132	295 GF295	->Chass. 005 441		
				1882 252 331	310 GFX310	Chass. 005 442->		
				1861 303 248	310 10 310GSB	Chass. 005 442->		
O 302 302.299 373.083 373.023 302.298 373.073 302.279 O 302 373.024 373.073 302.299 302.279 302.298 373.083 373.023 O 302 373.073 373.084 373.083 302.296 373.074	05.69 - 12.74	OM360.984, OM360.986, OM360.916, OM360.980, OM360.981, OM360.985, OM360.979		1882 234 433	350 GF350			
	05.69 - 12.74			1878 001 074	350 10 350GTZ			
	05.69 - 12.74							
O 302 Sonderausführung 302.244 302.214 302.295 302.281 302.230 302.254 302.274 302.284/285 302.201 302.270 302.261 302.264 302.251 302.235 302.241 302.250 302.255 302.294 302.220 302.225 302.231 302.265 302.224 302.245 302.275 302.280 302.291 302.211 302.234 302.240 302.290 302.203 302.206 302.208 302.215 302.221		OM327		1882 234 433	350 GF350	Sonderausführung / Special design (56)		
				1878 001 074	350 10 350GTZ	Sonderausführung / Special design (56)		
				3151 094 041	KZI-4	Sonderausführung / Special design (56)		
			OM360		1882 234 433	350 GF350	Chass. 797910-> 302.230-231/234-235/240-241/244-245/250-251 /254-255/261/201/203/206/208/220-221/224-225 /285/290-291/294-295/264-265/270/274-275/280 /281/284 Sonderausführung / Special design (56)	
				1878 001 074	350 10 350GTZ	302.240-241/244-245/261/264-265/280-281/284 /285/291/294-295/211/214-215/225/230-231/234 /235/290/270/274-275/250-251/254-255/201/203 /206/208/220-221/224 Sonderausführung / Special design (56)		
				3151 094 041	KZI-4	302.230-231/234-235/240-241/244-245/250-251 /254-255/261/201/203/206/208/220-221/224-225 /264-265/280-281/284-285/291/294-295/211/214 /215/290/270/274-275 Sonderausführung / Special design (56)		

















		CODE				
---	--	------	--	---	---	---

MERCEDES-BENZ

O 303		10.74 - 09.92									
O 303 NKWID gekurzt 301.342 301.353 300.210 301.515 301.374 301.313 301.324 301.344 600.495 300.484 301.524 301.385 301.525 301.335 301.394/395 301.533 600.484 301.305 301.312 600.415 300.435 300.485 301.513 301.314/315 301.345 301.364/365 301.375 301.523 301.534 600.485 300.290 300.414 300.494 301.323 301.362 301.393 600.414 600.290 301.373 600.494 301.325 300.495 300.415 600.210 301.343		OM421	 3482 124 534 430 GMF430 300.210/290	 1882 301 239 ● 420 GF420 300.210/290	 1878 003 657 420 10 420WGTZ 300.210/290	 3151 126 031 KZI-4,5 300.210/290					
		OM422	 3482 124 534 430 GMF430 301.334-335/342-343-344-345/353/362/364-365 /373-374-375/384-385/305/312-313-314-315/323 /324-325/525/533-534-535/393-394-395/513-514 /515/523-524	 1882 301 239 ● 420 GF420 301.334-335/342-343-344-345/353/362/364-365 /373-374-375/384-385/305/312-313-314-315/323 /324-325/525/533-534-535/393-394-395/513-514 /515/523-524	 1878 003 657 420 10 420WGTZ 301.334-335/342-343-344-345/353/362/364-365 /373-374-375/384-385/305/312-313-314-315/323 /324-325/525/533-534-535/393-394-395/513-514 /515/523-524	 3151 000 375 KZIS-4 ->Chass. 039682 301.334-335/342-343-344-345/353/362/364-365 /373-374-375/384-385/305/312-313-314-315/323 /324-325/525/533-534-535/393-394-395/513-514 /515/523-524	 3151 126 031 KZI-4,5 Chass. 39683-> 301.334-335/342-343-344-345/353/362/364-365 /373-374-375/384-385/305/312-313-314-315/323 /324-325/525/533-534-535/393-394-395/513-514 /515/523-524	 1882 342 134 420 GF420X 300.414-415/435/484-485/494-495	 3151 000 375 KZIS-4 ->Chass. 036733 300.414-415/435/484-485/494-495	 3151 126 031 KZI-4,5 Chass. 036734-> 300.414-415/435/484-485/494-495	
		OM441	 3482 081 232 430 MFZ430 600.210/290	 1878 080 033 430 10 430WGTZ 600.210/290	 3151 000 547 KZISZ-5 600.210/290 für Ausrückgabel mit Rollen / for release fork with rollers (70)						
		OM442	 3482 081 231 430 MFZ430 600.414-415/484-485/494-495	 1878 080 037 430 10 430WGTZ 600.414-415/484-485/494-495	 3151 000 547 KZISZ-5 600.414-415/484-485/494-495 für Ausrückgabel mit Rollen / for release fork with rollers (70)						
		O 303 301.102 301.106 301.124/125 301.100 301.110 301.123 301.103 301.112 301.121 301.130 301.105 301.126 301.120 301.122 301.160 301.101 301.104 O 303 301.111 301.131 301.161 O 303 301.165 301.113/114 301.133 301.135 301.162/163 301.115 301.136 301.166 301.116 301.132 301.112 301.164 301.134	10.74 - 06.83	OM401	 1882 311 131 # 350 GF350 301.130-136/160-166/100-106/110-116/120-126	 1878 001 147 # 350 10 350WGTZ 301.130-136/160-166/100-106/110-116/120-126	1878 001 144 350 10 350WGTZ 301.130-136/160-166/100-106/110-116/120-126	 3151 043 031 KZI-4,5 301.130-136/160-166/100-106/110-116/120-126			
			10.74 - 06.83								
			10.74 - 06.83								























		CODE					
---	--	------	--	--	---	---	---

MERCEDES-BENZ

O 303		10.74 - 09.92						
O 303 600.110 300.531 300.511 300.114 300.121 300.133 300.142 600.161 600.111 300.161/162 600.109 300.521 300.111 300.122 300.115 300.112 300.130 600.131 600.151 300.141 O 303 600.110 600.160 300.111 300.140 300.190 300.520 600.150 300.112 600.111 300.130 300.133 300.170 300.530 300.510 300.120 300.160 300.114/115 600.190 600.109	01.80 - 01.89	OM421		1882 302 131	380 GF380	->Chass. 053213 300.133/139-140/142-143-144-145/159-160 /162-165/519/529/109/112/114-115/123-124-125 /130/110-111/121/141/161/170/190/510-511/520 /521/530-531		
					1878 001 152	380 10 380WGTZ	->Chass. 053213 300.133/139-140/142-143-144-145/159-160 /162-165/519/529/109/112/114-115/123-124-125 /130/110-111/121/141/161/170/190/510-511/520 /521/530-531	
					3151 000 375	KZIS-4	300.110-111/121/141/161/170/190/510-511/520 /521/530-531/133/139-140/142-143-144-145/159 /160/162-165/519/529/109/112/114-115/123-124 /125/130	
					3151 126 031	KZI-4,5	Chass. 040653 - Chass. 053213 300.110-111/121/141/154/161/170/190/510-511 /520-521/530-531	
					3482 124 541	430 GMF430	Chass. 053214-> /162-165/519/529/109/112/114-115/123-124-125 /130/110-111/121/141/154/161/170/190/510-511 /520-521/530-531 300.133/139-140/142-143-144-145/159-160	
					1882 301 238 ●#	420 GF420	Chass. 053214-> 300.133/139-140/142-143-144-145/159-160 /162-165/519/529/109/112/114-115/123-124-125 /130/110-111/121/141/154/161/170/190/510-511 /520-521/530-531	
					1878 003 657	420 10 420WGTZ	Chass. 053214-> 300.133/139-140/142-143-144-145/159-160 /162-165/519/529/109/112/114-115/123-124-125 /130/110-111/121/141/154/161/170/190/510-511 /520-521/530-531	
					3151 000 375	KZIS-4	Chass. 053214-> 300.133/139-140/142-143-144-145/159-160 /162-165/519/529/109/112/114-115/123-124-125 /130	
					3151 126 031	KZI-4,5	Chass. 053214-> 300.110-111/121/141/154/161/170/190/510-511 /520-521/530-531	
			OM441		3400 123 001 ● 3482 081 232 ● 1878 080 031 ● 3151 000 549	430 10 MFZ430 430WGTZ KZISZ-5	600.110-111/134/150/153/160-161/190	
O 303 300.109 300.114 300.111/112 300.119 300.159 300.519 300.115 300.133 600.159 300.529 300.139 300.110 600.109 300.130	01.80 - 09.92	OM421		1882 302 131	380 GF380	->Chass. 053213 300.133/139-140/142-143-144-145/159-160 /162-165/519/529/109/112/114-115/123-124-125 /130		
				1878 001 152	380 10 380WGTZ	->Chass. 053213 /130 300.133/139-140/142-143-144-145/159-160 /162-165/519/529/109/112/114-115/123-124-125		
				3151 000 375	KZIS-4	->Chass. 053213 300.133/139-140/142-143-144-145/159-160 /162-165/519/529/109/112/114-115/123-124-125 /130		
				3482 124 541	430 GMF430	Chass. 053214-> 300.133/139-140/142-143-144-145/159-160 /162-165/519/529/109/112/114-115/123-124-125 /130		
				1882 301 238 ●#	420 GF420	Chass. 053214-> 300.133/139-140/142-143-144-145/159-160 /162-165/519/529/109/112/114-115/123-124-125 /130		
				1878 003 657	420 10 420WGTZ	Chass. 053214-> 300.133/139-140/142-143-144-145/159-160 /162-165/519/529/109/112/114-115/123-124-125 /130		
				3151 000 375	KZIS-4	Chass. 053214-> /162-165/519/529/109/112/114-115/123-124-125 /130 300.133/139-140/142-143-144-145/159-160		





























		CODE					
---	--	------	--	--	---	---	---

MERCEDES-BENZ

O 303		10.74 - 09.92					
O 303 300.143 300.163 300.124 300.144 300.164 600.110 600.153 300.111 300.114 300.123 300.130 300.133 300.165 600.111 600.134 300.115 300.145 300.112 300.154 600.109 300.125	01.80 - 09.92	OM421		1882 302 131	380 GF380	->Chass. 053213 300.110-111/121/141/154/161/170/190/510-511 /520-521/530-531/133/139-140/142-143-144-145 /159-160/162-165/519/529/109/112/114-115/123 /124-125/130	
				1878 001 152	380 10 380WGTZ	->Chass. 053213 300.133/139-140/142-143-144-145/159-160 /162-165/519/529/109/112/114-115/123-124-125 /130/110-111/121/141/154/161/170/190/510-511 /520-521/530-531	
				3151 000 375	KZIS-4	->Chass. 053213 300.133/139-140/142-143-144-145/159-160 /162-165/519/529/109/112/114-115/123-124-125 /130	
				3151 126 031	KZI-4,5	Chass. 040653 - Chass. 053213 300.110-111/121/141/154/161/170/190/510-511 /520-521/530-531	
				3482 124 541	430 GMF430	Chass. 053214-> 300.133/139-140/142-143-144-145/159-160 /162-165/519/529/109/112/114-115/123-124-125 /130/110-111/121/141/154/161/170/190/510-511 /520-521/530-531	
				1882 301 238 ●#	420 GF420	Chass. 053214-> 300.133/139-140/142-143-144-145/159-160 /162-165/519/529/109/112/114-115/123-124-125 /130/110-111/121/141/154/161/170/190/510-511 /520-521/530-531	
				1878 003 657	420 10 420WGTZ	Chass. 053214-> 300.133/139-140/142-143-144-145/159-160 /162-165/519/529/109/112/114-115/123-124-125 /130/110-111/121/141/154/161/170/190/510-511 /520-521/530-531	
				3151 000 375	KZIS-4	Chass. 053214-> 300.133/139-140/142-143-144-145/159-160 /162-165/519/529/109/112/114-115/123-124-125 /130	
				3151 126 031	KZI-4,5	Chass. 053214-> 300.110-111/121/141/154/161/170/190/510-511 /520-521/530-531	
		OM441		3400 123 001  3482 081 232  1878 080 031  3151 000 549	430 10 MFZ430 430WGTZ KZISZ-5	600.110-111/134/150/153/160-161/190	
O 303 300.210 300.290 O 303 300.314 300.312/313 300.315 300.335 300.342 300.322 300.305 300.323-325 300.334	11.85 - 04.89	OM421.951, OM422.917, OM422.908, OM441.950		1882 301 239	420 GF420		
	01.80 - 09.87			1878 003 657	420 10 420WGTZ		
				3151 126 031	KZI-4,5		
O 303 301.234/235 301.263 301.214/215 301.213 301.245 301.273 301.225 301.236 301.274 301.205 301.224 301.226 301.266 301.206 301.233 301.265 301.275 301.204 301.264 301.203 301.216 301.223	03.75 - 06.83	OM402		1882 302 131	380 GF380	301.233-236/245/263-266/273-275/203-206 /213-216/223-226	
				1878 001 152	380 10 380WGTZ	301.233-236/245/263-266/273-275/203-206 /213-216/223-226	
				3151 000 375	KZIS-4	/213-216/223-226 301.233-236/245/263-266/273-275/203-206	
O 303 600.210 600.290	12.87 - 09.92	OM441.953, OM441.950		3482 081 232	430 MFZ430		
				1878 080 033	430 10 430WGTZ		
				3151 000 547	KZISZ-5		

		CODE				
---	--	------	--	---	---	---





MERCEDES-BENZ

O 303		10.74 - 09.92					
O 303 300.305 300.314 300.323 300.345 300.364 300.395 300.515 300.524 300.373 300.335 300.384 300.393 300.514 300.534/535 300.334 300.342 300.375 300.523 300.525 300.374 300.385 300.312/313 300.315 300.324 300.344 300.363 300.365 300.394 300.343 300.513 300.362 300.533 300.325 373.195	01.80 - 09.87	OM422	 3482 124 534	430 GMF430	300.305/315/325/335/345/365/375/385/395/515 /525/535		
			 1882 301 239 ●	420 GF420	300.305/315/325/335/345/365/375/385/395/515 /525/535		
			 1878 003 657	420 10 420WGTZ	300.305/315/325/335/345/365/375/385/395/515 /525/535		
			 3151 000 375	KZIS-4	-> Chass. 039682 300.305/315/325/335/345/365/375/385/395/515 /525/535		
			 3151 126 031	KZI-4,5	Chass. 039683-> 300.305/315/325/335/345/365/375/385/395/515 /525/535		
			 3482 124 534	430 GMF430	Chass. 039683-> 300.515		
			 1882 301 239 ●	420 GF420	Chass. 039683-> 300.515		
			 1878 003 657	420 10 420WGTZ	Chass. 039683-> 300.515		
			 3151 126 031	KZI-4,5	Chass. 039683-> 300.515		
O 303 600.313/314 600.375 600.393 600.395 600.325 600.353 600.355 600.394 600.363-365 600.385 600.335 600.354 600.384 600.315	09.87 - 09.92	OM442	 3400 124 101	430 10 MFZ430 430WGTZ KZISZ-5	600.375/384-385/393-395/313-315/325/335 /353-355/363-365		
			 3482 081 232				
			 1878 005 668				
			 3151 000 549				
O 303 301.334 301.324/325 301.365 301.335 301.305 301.314 301.364 301.374 301.304 301.315 301.375	07.75 - 06.83	OM403	 3482 124 534	430 GMF430	301.304-305/314-315/324-325/334-335/364-365 /374-375		
			 1882 301 239 ●	420 GF420	301.304-305/314-315/324-325/334-335/364-365 /374-375		
			 1878 003 657	420 10 420WGTZ	301.304-305/314-315/324-325/334-335/364-365 /374-375		
			 3151 000 375	KZIS-4	301.304-305/314-315/324-325/334-335/364-365 /374-375		
O 303 300.415 300.485 300.495 300.484 300.494 300.414 300.435	08.80 - 09.87	OM422.963, OM422.951	 1882 342 134	420 GF420X			
			 1878 003 657	420 10 420WGTZ			
			 3151 000 375	KZIS-4	-> Chass. 036733		
			 3151 126 031	KZI-4,5	Chass. 036734->		
O 303 600.484/485 600.414 600.494/495 600.415	09.87 - 09.92	OM442.961, OM442.960, OM442.955, OM442.954	 3400 128 001	430 10 MFZ430 430WGTZ KZISZ-5			
			 3482 081 231				
			 1878 080 037				
			 3151 000 547				
O 305		09.67 - 05.87					
O 305 307.000 305.210/211 307.001 305.220		OM407	 1882 330 032 #	420 GF420	307.000-001		
			 1878 001 136	420 10 420GTZ	307.000-001		
			 3151 000 375	KZIS-4	307.000-001		
		OM360	 1861 470 234	380 10 380GSZ	Chass. 002085-> 305.210-211/220		













		CODE				
---	--	------	--	---	---	---

MERCEDES-BENZ

O 305 09.67 - 05.87

O 305 G 307.100/101	02.78 - 05.87	OM407.905, OM407.913, OM407.910,		1882 330 032 #	420 GF420		
O 305 G 307.100/101	02.79 - 05.87	OM407.908, OM407.909,		1878 001 136	420 10 420GTZ		
O 305 ST 307.001 307.050 307.055 307.000	04.73 - 07.77	OM407.914, OM407.911, OM407.917, OM407.951, OM407.955, OM407.919		3151 000 375	KZIS-4		
O 305 ST 305.210	01.70 - 05.73						
O 305 ST 307.000/001	11.76 - 05.87						
O 305 ST 307.001 307.000	04.73 - 07.77						
O 305 ST 307.001 307.000	11.76 - 05.87						
O 305 ST 307.001 307.000	02.79 - 05.87						
O 305 VÖV		OM360		1861 470 234	380 10 380GSZ		





















O 307 04.73 - 12.87

O 307 307.050 307.055 307.051		OM407		1882 330 032 #	420 GF420	->Chass. 000051 307.050-051/055	
				1878 001 136	420 10 420GTZ	->Chass. 000051 307.050-051/055	
				3151 000 375	KZIS-4	->Chass. 000051 307.050-051/055	
				1882 302 131	380 GF380	Chass. 000052 - Chass. 004702 307.050-051/055	
				1878 000 105	380 10 380GTZ	Chass. 000052 - Chass. 004702 307.050-051/055	
				3151 000 375	KZIS-4	Chass. 000052 - Chass. 004702 307.050-051/055	
				3482 124 541	430 GMF430	Chass. 004703-> 307.050-051/055	
				1882 301 238 ●#	420 GF420	Chass. 004703-> 307.050-051/055	
				1878 001 136	420 10 420GTZ	Chass. 004703-> 307.050-051/055	
				3151 000 375	KZIS-4	Chass. 004703-> 307.050-051/055	
O 307 307.001 307.050 307.055	04.73 - 07.77	OM407.905, OM407.918, OM407.915,		1882 330 032 #	420 GF420		
O 307 307.050 307.055	11.76 - 07.87	OM407.916, OM407.911, OM407.955, OM407.907		1878 001 136	420 10 420GTZ		
O 307 307.051 307.050 307.055	04.73 - 07.77			3151 000 375	KZIS-4		
O 307 307.050 307.055 307.051	04.73 - 07.77						
O 307 307.000 307.051	11.76 - 08.87						

		CODE				
---	--	------	--	---	---	---

MERCEDES-BENZ



O 309 01.68 - 02.89

O 309 D 309.172/173 309.171 309.183 309.190 309.181 309.191 309.182 O 309 D 323.386 323.389 323.382 O 309 D 602.487 602.466/467 602.461/462 602.476/477 602.471/472	OM615, 616, 621		3082 121 031	228 M228	Chass. 018154->		
			1861 557 236 #	228 10 228GSB	Chass. 018154 - Chass. 556499 309.181-183/191		
			1878 634 052	228 10 228GSB	Chass. 018154 - Chass. 556499 309.181-183/191		
			3151 034 031 ▲	KZI-1	Chass. 018154 - Chass. 028344 309.170-173/190/181-183-191		
			3151 000 206	KZIS-1	Chass. 028345 - Chass. 556499 309.181-183/191/170-173/190		
			3151 000 206	KZIS-1	Chass. 556500-> 309.170-191		
	OM314		1800 125 201  1882 205 234  1861 291 136  3151 044 031	250 10 HBX250 250GTZ KZI-3	Mot. 678175-> 309.370-371-372/382-383/390-391		
			1882 205 234	250 HBX250			
			1861 291 136	250 10 250GTZ	309.370-371-372/382-383/390-391		
			3151 095 043	KZI-3	->Chass. 018153 LHD ->Chass. 018729 RHD 309.370-371-372/382-383/390-391		
			3151 033 031	KZI-3	Chass. 018154 - Mot. 678174 Chass. 018729-> 309.370-371-372/382-383/390-391		
			3151 033 031	KZI-3	->Mot. 410747 310.383/389		
			3151 044 031	KZI-3	Mot. 410748-> 310.383/389		
		OM353		1882 317 131	280 HVB280	313.382/386/389	
			1861 632 032	280 10 280W2GSZ	->Chass. 346882 313.382/386/389		
			1861 919 134	280 10 280GTZ	Chass. 346883-> 313.382/386/389		
			3151 044 031	KZI-3	313.382/386/389		
				1863 869 010	35	Nadellager / Needle Bearing	(47)

O 311

O 311				1860 062 037 #	280 10 280Z	
--------------	--	--	---	-----------------------	-----------------------	--

O 317 09.58 - 02.76

O 317 317.226 317.201-204 317.228 317.206-209 317.230-236 317.240-248 317.214-222 317.224	OM326, 346		1881 041 656 #	380 G380	->Mot. 053185 317.226/228/230-236/240-248/201-204/206-209 /214-222/224 nicht für Motornummer / not for engine number: 050162-163	(98)
			1878 000 104	380 10 380GTZ	317.226/228/230-236/240-248/201-204/206-209 /214-222/224 nicht für Motornummer / not for engine number: 050162-163	(98)
			3151 000 529	KZIS-4	317.226/228/230-236/240-248/201-204/206-209 /214-222/224	







O 319

O 319 B	OM121		1881 059 208	200 KS200	->Chass. 004861	
			1861 123 236	200 10 200PE	->Chass. 004861	
O 319 D	OM621, 636		1881 059 208	200 KS200		
			1861 123 236	200 10 200PE		

		CODE					
---	--	------	--	--	---	---	---







MERCEDES-BENZ









O 320							
O 320				1881 039 532 #	350 G350KR	->Chass. 3500318	
				1861 034 147 #	350 10 350	->Chass. 3500318	

O 321							
O 321 H,HL		OM321, 322		1882 230 238	280 HVB280		
				1861 919 134	280 10 280GTZ		
				1882 230 238	280 HVB280	Sonderausführung / Special design	(56)
				1860 062 037 #	280 10 280Z	Sonderausführung / Special design	(56)
O 321 H,HL Sonderausführung		OM321, 322		1882 230 238	280 HVB280	Sonderausführung / Special design	(56)
				1860 062 037 #	280 10 280Z	Sonderausführung / Special design	(56)

O 322							
O 322				1882 230 238	280 HVB280		
				1861 919 134	280 10 280GTZ		
O 322 Sonderausführung				1882 230 238	280 HVB280		
				1860 062 037 #	280 10 280Z		











O 330							
O 330 600.345		OM442		3400 124 101 ⊗ 3482 081 232 ⊗ 1878 005 668 ⊙ 3151 000 549	430 10 MFZ430 430WGTZ KZISZ-5	600.345	



















O 340 01.91 - 06.95							
O 340 600.442				3482 081 231	430 MFZ430	600.442	
				1878 080 037	430 10 430WGTZ	600.442	
				3151 000 547	KZISZ-5	600.442	
O 340 600.342 600.344	01.91 - 06.95	OM441.994, OM441.995		3482 081 231	430 MFZ430		
				1878 080 033	430 10 430WGTZ		
				3151 000 547	KZISZ-5		
Tourismo 600.442	08.92 - 08.95	OM402.984, OM402.995		3400 128 001 ⊗ 3482 081 231 ⊗ 1878 080 037 ⊙ 3151 000 547	430 10 MFZ430 430WGTZ KZISZ-5		

O 345 (CONECTO) 11.01 -							
O 345, Euro 1 671.005		OM447HA		3421 601 012	430	mit Zahnkranz / with ring gear mit Anlauftring / with thrust ring	(93) (88)
				3482 081 232	430 MFZ430		
				1878 080 033	430 10 430WGTZ		
				3151 000 547	KZISZ-5		
O 345, Euro 2 671.000		OM449HLA		3421 601 012	430	mit Zahnkranz / with ring gear mit Anlauftring / with thrust ring	(93) (88)
				3482 081 232	430 MFZ430		
				1878 080 033	430 10 430WGTZ		
				3151 000 547	KZISZ-5		

		CODE					
---	--	------	--	--	---	---	---





























MERCEDES-BENZ

O 345 (CONECTO)		11.01 -					
O 345, Euro 2 671.010		OM447HLA		3421 601 012	430	mit Zahnkranz / with ring gear mit Anlauftring / with thrust ring	(93)
				3482 081 232	430 MFZ430		(88)
				1878 080 033	430 10 430WGTZ		
				3151 000 547	KZISZ-5		
CONECTO C, H, M, UE 671.021 671.030 671.042 671.015 671.020	11.01 -	OM906		3482 081 231	430 MFZ430		
				1878 080 033	430 10 430WGTZ		
CONECTO C, H, UE 671.030 671.015 671.020 671.042	11.01 -	OM457		3482 081 232	430 MFZ430		
				1878 080 034	430 10 430WGTZ		
CONECTO C, H, M, UE 671.021 671.030 671.020 671.042 671.015	11.01 -	OM906.960, OM457.942		3151 000 335	KZISZ-5	für OE-Nummer / for OE number 002 250 44 15	(83)
CONECTO C, H, M, UE 671.021 671.020 671.015 671.030 671.942	11.01 -			3151 000 278	KZISZ-5	für OE-Nummer / for OE number 001 250 98 15	(83)
				3151 000 547	KZISZ-5	für OE-Nummer / for OE number 001 250 86 15	(83)
						für OE-Nummer / for OE number 002 250 08 15	(83)
						für OE-Nummer / for OE number 001 250 88 15	(83)

O 350 (TOURISMO)		09.94 -					
Tourismo RHD 632.035/036 632.038 632.037		OM457		3482 000 852	430 MFZ430	632.036/038	
				1878 005 541	430 10 430WGTZ	632.036/038	
				3151 000 335	KZISZ-5	632.036/038	
O 350 613.355 613.385		OM441LA		3482 081 231	430 MFZ430	613.355/385	
				1878 080 033	430 10 430WGTZ	613.355/385	
				3151 000 278	KZISZ-5	613.355/385	
				3482 081 231	430 MFZ430	613.355/385 Länderausführung: Türkei / Country Version: Turkey	(41)
				3151 000 547	KZISZ-5	613.355/385 Länderausführung: Türkei / Country Version: Turkey	(41)
O 350 613.455 613.485		OM402LA		3400 122 601 ⊗ 3482 081 231 ⊗ 1878 080 037 ⊙ 3151 000 278	430 10 MFZ430 430WGTZ KZISZ-5	613.455/485	
				3400 128 001 ⊗ 3482 081 231 ⊗ 1878 080 037 ⊙ 3151 000 547	430 10 MFZ430 430WGTZ KZISZ-5	Länderausführung: Türkei / Country Version: Turkey	(41)
Tourismo 613.455	08.95 -	OM446.938		3482 081 231	430 MFZ430		
				1878 080 034	430 10 430WGTZ	für / for: SA504902-02	(68)
				1878 080 037	430 10 430WGTZ	->Chass. 1038/99, 07.02.00 für / for: SA504902-02	(68)
				3151 000 157	KZISZ-5	für / for: SA504901-04 für / for: SA504901-03	(68) (68)
				3151 000 547	KZISZ-5	für / for: SA504901-02	(68)
Tourismo RHD, SHD 613.388 613.358	09.03 -	OM457.944		3482 081 233	430 MFZ430		
				1878 080 034	430 10 430WGTZ		
				3151 000 335	KZISZ-5		
				6594 000 079	430 430Z	für / for: SA 522019-03 für / for: SA 522019-08 für / for: SA 522019-15 enthält Schwungradbefestigungsschrauben / includes bolt for flywheel mounting	(68) (68) (68) (65)
				1863 869 028		für / for: SA 522019-03 für / for: SA 522019-08 für / for: SA 522019-15	(68) (68) (68)























		CODE				
---	--	------	--	---	---	---

MERCEDES-BENZ

O 350 (TOURISMO) 09.94 -							
Tourismo RHD, SHD 613.358 613.388	09.03-	OM457.944		3482 081 233	430 MFZ430		
				1878 080 034	430 10 430WGTZ		
				3151 000 335	KZISZ-5		
				6594 000 079	430 430Z	enthält Schwungradbefestigungsschrauben / includes bolt for flyweel mounting (65)	
				1863 869 028			
O 402 10.85 - 12.91							
O 402 697.051	02.86 - 12.91	OM366		3400 122 401 ● 3482 008 038 ● 1861 964 034 ○ 3151 044 031	310 10 MF310 310WGSZ KZI-3	697.051	
				3482 012 240	330 GMF330	697.056	
O 402 697.056	02.86 - 12.91	OM366A		1861 963 033	330 10 330WGSZ	697.056	
				3151 044 031	KZI-3	697.056	
O 403 01.95 - 12.06							
O 403 613.355 613.385		OM441LA		3400 128 001 ● 3482 081 231 ● 1878 080 037 ○ 3151 000 547	430 10 MFZ430 430WGTZ KZISZ-5	Länderausführung: Türkei / Country Version: Turkey (41)	
				3482 081 231	430 MFZ430	Länderausführung: Türkei / Country Version: Turkey (41)	
		OM402LA		1878 080 037	430 10 430WGTZ	Länderausführung: Türkei / Country Version: Turkey (41)	
				3151 000 157	KZISZ-5	Länderausführung: Türkei / Country Version: Turkey (41)	
O 403 - RHD E3 613.355 613.385		OM457LA		6594 000 079	430 430Z	für OE-Nummer / for OE number 457 030 13 05 enthält Schwungradbefestigungsschrauben / includes bolt for flyweel mounting (83) (65)	
O 404 09.91 - 10.99							
O 404 356.143 618.000 356.133 356.163 356.113 618.335 356.153 356.123		OM441LA		3400 123 001 ● 3482 081 232 ● 1878 080 031 ○ 3151 000 549	430 10 MFZ430 430WGTZ KZISZ-5	356.113/123/133/143/153/163	
				3482 081 233	430 MFZ430	618.335	
				1878 002 735	430 10 430GTZ	618.335	
				3151 000 157	KZISZ-5	618.335	
				3482 081 232	430 MFZ430	618.000	
				1878 080 033	430 10 430WGTZ	618.000	
				3151 000 547	KZISZ-5	618.000 für Ausrückgabel mit Rollen / for release fork with rollers (70)	
O 404 356.030	09.91 - 01.92	OM441		3482 081 232	430 MFZ430	356.030	
O 404 356.030	09.91 - 01.92			1878 080 031	430 10 430WGTZ	356.030	
				3151 000 547	KZISZ-5	356.030	
O 404 356.225 356.235	09.91 - 01.92	OM442		3400 124 101 ● 3482 081 232 ● 1878 005 668 ○ 3151 000 549	430 10 MFZ430 430WGTZ KZISZ-5	356.225/235/255	
	09.91 - 01.92						
O 404 356.140 356.110 356.130 356.160 356.150 356.120	09.91 - 10.99	OM401LA		3482 081 232	430 MFZ430	356.140/145/150/155/160/165/110/115/120/125 /130/135 614.115	
				1878 080 033	430 10 430WGTZ	356.140/145/150/155/160/165/110/115/120/125 /130/135 614.115	
				3151 000 547	KZISZ-5	356.140/145/150/155/160/165/110/115/120/125 /130/135	
O 404 615.115 356.160 356.110 356.120 356.150 356.130 356.140	09.91 - 10.99						































		CODE				
---	--	------	--	---	---	---

MERCEDES-BENZ

O 404		09.91 - 10.99				
O 404 356.100 356.110 356.130 356.155 356.160 356.120 356.150 356.170 356.140	09.91 - 10.99	OM401LA	 3482 081 232	430 MFZ430		
			 1878 080 033	430 10 430WGTZ		
O 404 356.110 356.140 356.173 356.100 356.130 356.170 356.175 356.113 356.155 356.105 356.150 356.153 356.120 356.123 356.133 356.160 356.163 356.125 356.103 356.165 356.145 356.115 356.135 356.143	09.91 - 10.99		 3151 000 547	KZISZ-5	für Ausrückgabel mit Rollen / for release fork with rollers	(70)
O 404 356.333 356.105 614.313 618.133 614.315 356.323 618.103 618.113 618.123 356.363 614.345 356.353	09.91 - 10.99	OM441LA	 3400 124 101	430 10 MFZ430	->Chass. 069374	
			 3482 081 232	430WGTZ	356.323	
			 1878 005 668	KZISZ-5		
			 3151 000 549			
			 1878 080 033	430 10 430WGTZ	Chass. 069375->	
			 3482 081 231	430 MFZ430	356.323	
O 404 618.133 618.145 618.203 356.343 356.375 356.415 356.105 356.113 356.305 614.313 618.135 356.345 356.365 614.315 356.395 356.405 618.113 618.115 356.325 356.303 356.335 356.353 614.345 618.105 618.123 356.315 356.355 356.323 356.313 618.125 618.205 356.385 356.363 356.373	09.91 - 10.99	OM441LA	 3482 081 231	430 MFZ430	356.353/355/363/365/385/395/313/315/325/333 /335/345	
			 1878 080 033	430 10 430WGTZ	614.313/315/345 356.323/343	
			 3151 000 547	KZISZ-5	614.313/315/345 356.323/343	
			 3151 000 157 ●	KZISZ-5	356.353/355/363/365/385/395/313/315/325/333 /335/345	
			 3482 081 231	430 MFZ430	614.313/315/345 356.323/343	
			 1878 080 034	430 10 430WGTZ	614.313/315/345 356.323/343	
O 404 618.223 618.213 618.233 618.203 614.428	09.94 - 10.99	OM446.938	 3482 081 231	430 MFZ430		
			 1878 080 037	430 10 430WGTZ		
			 3151 000 547	KZISZ-5		
O 404 614.435 614.445 614.115 356.313 356.405 614.415 356.323 356.363 356.445 614.428 356.465 356.495 614.313 356.343 356.435 356.455 356.425 356.443 356.485 356.373 356.415 356.353	09.91 - 10.99	OM402LA	 3400 128 001	430 10 MFZ430		
			 3482 081 231	430WGTZ		
			 1878 080 037	KZISZ-5		
			 3151 000 547	KZISZ-5		
			 3151 000 157 ●	KZISZ-5		





		CODE				
---	--	------	--	---	---	---



















MERCEDES-BENZ

O 405		09.84 -				
O 405 612.312 612.514 612.522-525 357.432 612.116 357.420 612.410-413 612.110 612.400-402 357.402 357.486 612.512 357.424 357.580 357.400 357.410 357.442 357.480 357.484 357.415 357.422 357.430 357.434 357.444 612.323 357.404 612.322 612.420 357.440 357.406	OM447	 3482 124 522	430 GMF430	612.110/116		
		 1882 342 134 ●	420 GF420X	612.110/116		
		 1878 003 657	420 10 420WGTZ	612.110/116		
		 3151 126 031	KZI-4,5	612.110/116		
		OM427, 447	 3482 124 522	430 GMF430	357.000-001/004-005 Sonderausführung / Special design	(56)
			 1882 342 134 ●	420 GF420X	357.000-001/004-005 Sonderausführung / Special design	(56)
			 1862 211 031 #	420 10 420WGSZ	357.000-001/004-005 Sonderausführung / Special design	(56)
			 3151 126 031	KZI-4,5	357.000-001/004-005 Sonderausführung / Special design	(56)
			 3482 124 522	430 GMF430	Getr. / GBox: DB 3/60-S4	
					Sonderausführung / Special design	(56)
	 1882 342 134 ●		420 GF420X	Getr. / GBox: DB 3/60-S4		
				Sonderausführung / Special design	(56)	
	 1878 001 136		420 10 420GTZ	Getr. / GBox: DB 3/60-S4 357.000-001 Sonderausführung / Special design	(56)	
	 3151 000 375		KZIS-4	Getr. / GBox: DB 3/60-S4 357.000-001 Sonderausführung / Special design	(56)	
	 3482 124 522	430 GMF430	Getr. / GBox: ZF S4-90			
			Sonderausführung / Special design	(56)		
	 1882 342 134 ●	420 GF420X	Getr. / GBox: ZF S4-90			
			Sonderausführung / Special design	(56)		
	 1862 211 031 #	420 10 420WGSZ	Getr. / GBox: ZF S4-90 357.000-001 Sonderausführung / Special design	(56)		
	 3151 000 375	KZIS-4	Getr. / GBox: ZF S4-90 357.000-001 Sonderausführung / Special design	(56)		
 3482 124 522	430 GMF430	357.010-011				
		Sonderausführung / Special design	(56)			
 1882 342 134 ●	420 GF420X	357.010-011				
		Sonderausführung / Special design	(56)			
 3151 126 031	KZI-4,5	357.010-011 Sonderausführung / Special design	(56)			
O 405 G,O 405 GN,O 405 GTD 357.530 612.312 612.514 612.512 357.550 357.552 357.210 357.250 357.200/201 357.532	11.85-	OM427.911, OM447.907	 3482 124 522	430 GMF430	357.200-201	
			 1882 342 134 ●	420 GF420X	357.200-201	
			 1878 003 662	420 10 420WGTZ	357.200-201	
			 3151 126 031	KZI-4,5	357.200-201	
O 405 ST,O 405 N 612.000 612.402 357.001 612.001 612.407 357.000 357.401 357.422 357.425 357.450/451 612.400 357.420 357.410 612.401 357.400 612.403 357.002 357.402 357.404 357.424 357.454/455 O 405 ST 357.010/011 357.000/001	12.84-	OM447.905, OM427.905, OM447.950, OM447.970, OM447.951, OM447.973, OM447.911, OM447.914, OM427.950, OM447.913	 3482 124 522	430 GMF430	für OE-Nummer / for OE number 004 250 00 04 für OE-Nummer / for OE number 005 250 19 04 357.000-001	(83) (83)
				 1882 342 134 ●	420 GF420X	357.000-001
			 1862 211 031 #	420 10 420WGSZ	für OE-Nummer / for OE number 015 250 33 03 für OE-Nummer / for OE number 012 250 33 03 für OE-Nummer / for OE number 008 250 95 03 357.000-001	(83) (83) (83)
					 1878 001 136	420 10 420GTZ
	 1878 003 662	420 10 420WGTZ	für OE-Nummer / for OE number 019 250 37 03 357.000-001	(83)		
			 3151 126 031	KZI-4,5	für OE-Nummer / for OE number 000 250 76 15 357.000-001	(83)
	 3151 000 375	KZIS-4	für OE-Nummer / for OE number 000 250 74 15 für OE-Nummer / for OE number 000 250 77 15 357.000-001	(83) (83)		

		CODE				
---	--	------	--	---	---	---























MERCEDES-BENZ

O 405		09.84 -					
O 405 ST,O 405 N 612.418 612.616 357.001 357.415 357.435 612.405 357.436 612.011 357.000 612.411 612.417 357.430 612.412/413 357.460/461 357.404 357.005 357.464/465 357.004 357.200 357.432 357.434 357.438 612.010 612.410 612.416 357.406 357.466	11.85-	OM447.908, OM447.910, OM447.906, OM447.996, OM427.911, OM447.956, OM447.957, OM447.907, OM427.910, OM447.974, OM447.971	 3482 124 522	430 GMF430	für OE-Nummer / for OE number 004 250 00 04 für OE-Nummer / for OE number 005 250 19 04 357.000-001/004-005 612.010-011	(83)	(83)
			 1882 342 134 ●	420 GF420X	357.000-001/004-005 612.010-011		
			 1862 211 031 #	420 10 420WGSZ	für OE-Nummer / for OE number 015 250 33 03 für OE-Nummer / for OE number 012 250 33 03 für OE-Nummer / for OE number 008 250 95 03 357.000-001/004-005	(83)	(83)
			1878 001 136	420 10 420GTZ	für OE-Nummer / for OE number 007 250 13 03 für OE-Nummer / for OE number 007 250 12 03 für OE-Nummer / for OE number 005 250 97 03 357.000-001	(83)	(83)
			1878 003 662	420 10 420WGTZ	für OE-Nummer / for OE number 019 250 37 03 357.000-001/004-005 612.010-011	(83)	(83)
			 3151 126 031	KZI-4,5	für OE-Nummer / for OE number 000 250 76 15 357.000-001/004-005 612.010-011	(83)	(83)
			3151 000 375	KZIS-4	für OE-Nummer / for OE number 000 250 74 15 für OE-Nummer / for OE number 000 250 77 15 357.000-001	(83)	(83)

O 407		03.87 - 11.01					
O 407 357.100 357.110		OM447	 3482 124 522	430 GMF430	357.100/110		
			 1882 342 134 ●	420 GF420X	357.100/110		
			 1862 211 031 #	420 10 420WGSZ	357.100/110		
			 3151 126 031	KZI-4,5	357.100/110		
			 3482 124 534	430 GMF430	357.110 Sonderausführung / Special design	(56)	
			 1882 301 239 ●	420 GF420	357.110 Sonderausführung / Special design	(56)	
			 1862 211 031 #	420 10 420WGSZ	357.110 Sonderausführung / Special design	(56)	
			 3151 126 031	KZI-4,5	357.110 Sonderausführung / Special design	(56)	
O 407 357.110 612.110 357.100 612.116	03.87 - 11.01	OM447.906, OM447.908	 3482 124 522	430 GMF430	für OE-Nummer / for OE number 005 250 19 04 für OE-Nummer / for OE number 004 250 00 04 357.100/110	(83)	(83)
			 1882 342 134 ●	420 GF420X	357.100/110		
			 1878 003 662	420 10 420WGTZ	für OE-Nummer / for OE number 015 250 33 03 für OE-Nummer / for OE number 012 250 33 03 für OE-Nummer / for OE number 008 250 95 03 für OE-Nummer / for OE number 007 250 12 03 357.100/110	(83)	(83)
			 3151 126 031	KZI-4,5	für OE-Nummer / for OE number 000 250 76 15 357.100/110	(83)	
		OM447.990	 3482 124 522	430 GMF430	612.110/116		
			 1882 342 134 ●	420 GF420X	612.110/116		
			 1878 003 662	420 10 420WGTZ	für OE-Nummer / for OE number 015 250 37 03 für OE-Nummer / for OE number 005 250 97 03 für OE-Nummer / for OE number 019 250 36 03 612.110/116	(83)	(83)
			 1878 001 136	420 10 420GTZ	für OE-Nummer / for OE number 007 250 13 03 612.110/116	(83)	
			 1878 002 706	420 10 420GTZ	für OE-Nummer / for OE number 007 250 43 03 für OE-Nummer / for OE number 007 250 42 03 612.110/116	(83)	(83)
			 3151 126 031	KZI-4,5	612.110/116		



		CODE					
---	--	------	--	--	---	---	---



MERCEDES-BENZ























O 407		03.87 - 11.01							
O 407 357.120 612.120 357.130 612.126	11.91 - 11.01	OM447.991, OM447.985	 3482 124 522	430 GMF430					
			1882 342 134 ●	420 GF420X					
			 1878 002 706	420 10 420GTZ	für / for: TELMA-Bremse		(68)		
			1878 003 657	420 10 420WGTZ	nicht für / not for: TELMA-Bremse		(96)		
			 3151 126 031	KZI-4,5					
O 408		09.89 - 12.98							
O 408 612.216 357.160 357.150	01.91 - 12.98	OM447.908, OM447.912	 3482 124 522	430 GMF430	für OE-Nummer / for OE number 005 250 19 04 für OE-Nummer / for OE number 004 250 00 04 357.150/160		(83) (83)		
			1882 342 134 ●	420 GF420X	357.150/160				
			 1878 003 662	420 10 420WGTZ	für OE-Nummer / for OE number 015 250 33 03 für OE-Nummer / for OE number 012 250 33 03 für OE-Nummer / for OE number 008 250 95 03 für OE-Nummer / for OE number 007 250 12 03 357.150/160		(83) (83) (83) (83)		
			 3151 126 031	KZI-4,5	für OE-Nummer / for OE number 000 250 76 15 357.150/160		(83)		
			OM447.992	 3482 124 522	430 GMF430	612.216			
				1882 342 134 ●	420 GF420X	612.216			
				 1878 003 662	420 10 420WGTZ	für OE-Nummer / for OE number 019 250 36 03 für OE-Nummer / for OE number 015 250 37 03 für OE-Nummer / for OE number 005 250 97 03 612.216		(83) (83) (83)	
				 1878 001 136	420 10 420GTZ	für OE-Nummer / for OE number 007 250 13 03 612.216		(83)	
		 1878 002 706		420 10 420GTZ	für OE-Nummer / for OE number 007 250 43 03 für OE-Nummer / for OE number 007 250 42 03 612.216		(83) (83)		
		 3151 126 031		KZI-4,5	612.216				
		O 408 612.226 357.180 357.170	08.92 - 12.98	OM447.987, OM447.993	 3482 124 522	430 GMF430			
					1882 342 134 ●	420 GF420X			
					 1878 002 706	420 10 420GTZ	für / for: TELMA-Bremse		(68)
					1878 003 657	420 10 420WGTZ	nicht für / not for: TELMA-Bremse		(96)
 3151 126 031	KZI-4,5								
O 408 357.180 612.216 612.226 357.150 357.160		OM447	 3482 124 522	430 GMF430	357.150/160/180				
			1882 342 134 ●	420 GF420X	357.150/160/180				
			 1862 211 031 #	420 10 420WGSZ	357.150/160/180				
			 3151 126 031	KZI-4,5	357.150/160/180				
			 3482 124 522	430 GMF430	612.216				
					1882 342 134 ●	420 GF420X	612.216		
					 1878 003 657	420 10 420WGTZ	612.216		
			 3151 126 031	KZI-4,5	612.216				
			 3482 124 522	430 GMF430	612.226				
					1882 342 134 ●	420 GF420X	612.226		
					 3151 126 031	KZI-4,5	612.226		

		CODE				
---	--	------	--	---	---	---

MERCEDES-BENZ

O 500 (Touro)		01.00 -			
Touro 634.203	10.01 -	OM457	 3400 700 509  430 10 XTend Nabenprofil / Hub Profile: 41,1x50,8-10N Nur zusammen verbauen / Only install together	(46) (51)	
Touro 634.203	10.01 -	OM457.944	 6594 000 079 430 430Z	für / for: SA522019-08/15 enthält Schwungradbefestigungsschrauben / includes bolt for flywheel mounting	(68) (65)

















O 510 (TOURINO)		10.03 -		
TOURINO 444.203 444.200	10.03 -	OM906.962, OM926.939, OM906.961	 3482 000 463 395 MF395	
TOURINO 444.200 444.203	10.03 -		 1878 003 784 395 18 395WGTZ	
TOURINO 444.303			 3151 000 396 KZIS-4	

O 530 (CITARO)		01.98 -			
Citaro		OM457hLA	 6594 000 079 430 430Z	für OE-Nummer / for OE number 457 030 13 05 enthält Schwungradbefestigungsschrauben / includes bolt for flywheel mounting	(83) (65)
Citaro L 628.147/148 628.143 628.101 628.100 628.145	01.99 -	OM909.921, OM906.930, OM909.901, OM906.960	 3482 081 232 430 MFZ430	->Chass. 099808 628.143/145/148	
			 3482 081 231 430 MFZ430	Chass. 099809-> 628.143/145/148	
		OM457	 1878 080 033 430 10 430WGTZ	628.143/145/148	
		OM906	 1878 080 033 430 10 430WGTZ	628.143/145/148	
Citaro N 628.000/001	01.98 -	OM906.931, OM909.911, OM909.900	 3482 081 232 430 MFZ430	für / for: SA 504903-03 628.000	(68)
			 1878 080 033 430 10 430WGTZ	für / for: SA 504902-07 628.000	(68)
			 3151 000 335 KZIZ-5	für / for: SA 504901-04 für / for: SA 504905-06/07 für / for: SA 504905-08/09 628.000	(68) (68) (68)
			 3151 000 547 KZISZ-5	für / for: SA 504901-02 für / for: SA 504905-05 628.000	(68) (68)
			 3151 000 278 KZISZ-5	für / for: SA 504901-05 628.000	(68)
			 3482 081 232 430 MFZ430	->Chass. 099808 für / for: SA 504903-03 628.001	(68)
			 3482 081 231 430 MFZ430	Chass. 099809-> für / for: SA 504903-04 628.001	(68)
			 1878 080 033 430 10 430WGTZ	für / for: SA 504902-06 628.001	(68)
			 1878 080 037 430 10 430WGTZ	für / for: SA 504902-04 628.001	(68)
			 3151 000 335 KZIZ-5	für / for: SA 504901-04 für / for: SA 504905-06/07 für / for: SA 504905-08/09 628.001	(68) (68) (68)
			 3151 000 547 KZISZ-5	für / for: SA 504901-02 für / for: SA 504905-05 628.001	(68) (68)
			 3151 000 278 KZISZ-5	für / for: SA 504901-05 628.001	(68)
		OM906	 1878 080 033 430 10 430WGTZ	628.001	
Citaro N 628.043 628.045 628.050 628.040	04.99 -	OM906.962, OM906.963	 3482 081 232 430 MFZ430	->Chass. 099808 628.043/045	
			 3482 081 231 430 MFZ430	Chass. 099809-> 628.043/045	
		OM457	 1878 080 033 430 10 430WGTZ	628.043/045	
		OM906	 1878 080 033 430 10 430WGTZ	628.043/045	











		CODE				
---	--	------	--	---	---	---

MERCEDES-BENZ

O 530 (CITARO) 01.98 -







Citaro N 628.050 628.045 628.000 628.002 628.040 628.047/048 628.043 628.447 628.001	01.98 -	OM909.921, OM906.930, OM909.901, OM906.960, OM906.961		3482 081 232	430 MFZ430	->Chass. 099808 628.043/045/047-048	
				3482 081 231	430 MFZ430	Chass. 099809-> 628.043/045/047-048	
		OM457		1878 080 033	430 10 430WGTZ	628.043/045/047-048	
		OM906		1878 080 033	430 10 430WGTZ	628.043/045/047-048	
Citaro N, Citaro MUE 628.083 628.085 628.447 628.000/001 628.080 628.087 628.040	01.98 -	OM457.934, OM457.959, OM457.950, OM457.949, OM457.973, OM457.942		3482 081 232	430 MFZ430	für / for: SA 504903-03 628.000	(68)
				1878 080 033	430 10 430WGTZ	für / for: SA 504902-07 628.000	(68)
				3151 000 335	KZIZ-5	für / for: SA 504901-04 für / for: SA 504905-06/07 für / for: SA 504905-08/09 628.000	(68) (68) (68)
				3151 000 547	KZISZ-5	für / for: SA 504901-02 für / for: SA 504905-05 628.000	(68) (68)
				3151 000 278	KZISZ-5	für / for: SA 504901-05 628.000	(68)
				3482 081 232	430 MFZ430	->Chass. 099808 für / for: SA 504903-03 628.001	(68)
				3482 081 231	430 MFZ430	Chass. 099809-> für / for: SA 504903-04 628.001	(68)
				1878 080 033	430 10 430WGTZ	für / for: SA 504902-06 628.001	(68)
				1878 080 037	430 10 430WGTZ	für / for: SA 504902-04 628.001	(68)
				3151 000 335	KZIZ-5	für / for: SA 504901-04 für / for: SA 504905-06/07 für / for: SA 504905-08/09 628.001	(68) (68) (68)
				3151 000 547	KZISZ-5	für / for: SA 504901-02 für / for: SA 504905-05 628.001	(68) (68)
				3151 000 278	KZISZ-5	für / for: SA 504901-05 628.001	(68)
			OM906		1878 080 033	430 10 430WGTZ	628.001
		OM457.934/942		1863 869 028		für / for: SA 522019-03/08/15 628.000/001	(68)





O 550 (INTEGRO) 09.96 -





















O 550		OM447hLA, OM457hLA		3400 700 451  3482 081 231  1878 080 031  3151 000 157	430 10 MFZ430 430WGTZ KZISZ-5	Getr. / GBox: ZF 6F-85	
		OM441LA		3482 081 233	430 MFZ430	Getr. / GBox: G04/160	
				1878 080 033	430 10 430WGTZ	Getr. / GBox: G04/160	
				3151 000 547	KZISZ-5	Getr. / GBox: G04/160	
Integro L Integro L 633.004 Integro L 633.004 Integro M Integro 12M	01.06 -	OM457hLA		3400 700 509 	430 10	XTend Nabenprofil / Hub Profile: 41,1x50,8-10N Nur zusammen verbauen / Only install together	(46) (51)
	01.06 -			6594 000 079	430 430Z	für / for: SA522019-08/15 enthält Schwungradbefestigungsschrauben / includes bolt for flywheel mounting	(68) (65)
				1863 869 028			

		CODE					
---	--	------	--	--	---	---	---

MERCEDES-BENZ































O 550 (INTEGRO)		09.96 -					
Integro, Integro M 633.001/002 Integro, Integro M 633.002 633.001	01.06-	OM457LA		3482 000 852	430 MFZ430	je nach Ausführung, mit unterschiedlicher Kupplung / depending on version, with different clutch	(85)
	01.06-			1878 005 541	430 10 430WGTZ	je nach Ausführung, mit unterschiedlicher Kupplung / depending on version, with different clutch	(85)
				3151 000 335	KZIZ-5	je nach Ausführung, mit unterschiedlicher Kupplung / depending on version, with different clutch	(85)
				3400 700 509 	430 10	XTend Nabenprofil / Hub Profile: 41,1x50,8-10N je nach Ausführung, mit unterschiedlicher Kupplung / depending on version, with different clutch Nur zusammen verbauen / Only install together	(46) (85) (51)
				6594 000 079	430 430Z	für / for: SA522019-08/15 enthält Schwungradbefestigungsschrauben / includes bolt for flywheel mounting	(68) (65)
				1863 869 028			

INTOURO		01.05 -					
Intouro, Intouro E, Intouro M, Intouro ME 633.251 633.052 633.252 633.051 Intouro, Intouro E, Intouro M, Intouro ME 633.052 633.251/252 633.051 Intouro, Intouro E, Intouro M, Intouro ME 633.252 633.251 633.051/052 Intouro, Intouro E, Intouro M, Intouro ME 633.051/052 633.251/252	01.05-	OM457.965, OM926.939		3482 000 463	395 MF395		
	01.05-			1878 006 173	395 18 395WGTZ		
				3151 000 396	KZIS-4		
	01.05-	OM457		1863 869 028			
	01.05-						

O 580 (TRAVEGO)		10.99 -					
Travego 629.015 632.005 632.012 632.010 632.006/007				3400 700 509 	430 10	XTend Nabenprofil / Hub Profile: 41,1x50,8-10N Nur zusammen verbauen / Only install together	(46) (51)
				6594 000 079	430 430Z	für / for: SA 522019-15 enthält Schwungradbefestigungsschrauben / includes bolt for flywheel mounting	(68) (65)
				1863 869 028			
Travego		OM470		3400 700 537 	430 18	XTend 632.400 Nabenprofil / Hub Profile: 45x50-18N Nur zusammen verbauen / Only install together	(46) (51)
				6594 000 218	430 632.400		
				3151 001 082 	KZISZ-5	632.400	
Travego L	01.05-	OM457LA		3400 700 509 	430 10	XTend 632.246 Nabenprofil / Hub Profile: 41,1x50,8-10N Nur zusammen verbauen / Only install together	(46) (51)
				6594 000 079	430 430Z	für / for: SA 522019-15 632.246 enthält Schwungradbefestigungsschrauben / includes bolt for flywheel mounting	(68) (65)
				1863 869 028		632.246	
				3400 700 531 	430 18	XTend Getr. / GBox: Powershift 632.450 Nabenprofil / Hub Profile: 45x50x-18N max. übertragbares Motormoment [Nm] / max. transmittable engine torque [Nm]: 2100 Nur zusammen verbauen / Only install together	(46) (87) (51)
				3400 700 537 	430 18	XTend 632.450 Nabenprofil / Hub Profile: 45x50-18N Nur zusammen verbauen / Only install together	(46) (51)
				3151 001 082 	KZISZ-5	632.450	
			OM470		6594 000 218	430 632.450	
	OM471		6594 000 219	430 632.450			



		CODE				
---	--	------	--	---	---	---



MERCEDES-BENZ







O 580 (TRAVEGO)		10.99 -					
Travego M	01.05 -	OM457LA	 3400 700 509 	430 10	XTend 632.246 Nabenprofil / Hub Profile: 41,1x50,8-10N Nur zusammen verbauen / Only install together	(46) (51)	
			 6594 000 079	430 430Z	für / for: SA 522019-15 632.246 enthält Schwungradbefestigungsschrauben / includes bolt for flywheel mounting	(68) (65)	
			 1863 869 028		632.246		
		OM470/471		 3400 700 537 	430 18	XTend 632.430 Nabenprofil / Hub Profile: 45x50-18N Nur zusammen verbauen / Only install together	(46) (51)
					3400 700 531 	430 18	XTend Getr. / GBox: Powershift 632.430 Nabenprofil / Hub Profile: 45x50x-18N max. übertragbares Motormoment [Nm] / max. transmittable engine torque [Nm]: 2100 Nur zusammen verbauen / Only install together
				 3151 001 082 		KZISZ-5 632.430	
				OM470	 6594 000 218	430	632.430
OM471	 6594 000 219	430	632.430				
O 580-15 RH/RHD 629.001 629.011 632.006 632.010 O 580-15 RH/RHD 629.001 629.011 O 580-15 RHD 632.010 629.011 629.001	10.99 -	OM457.940, OM457.936, OM457.961, OM457.938, OM457.944, OM457.953	 3482 081 233	430 MFZ430	629.001/011 je nach Ausführung, mit unterschiedlicher Kupplung / depending on version, with different clutch	(85)	
	10.99 -		 1878 080 034	430 10 430WGTZ	629.001/011 je nach Ausführung, mit unterschiedlicher Kupplung / depending on version, with different clutch	(85)	
	10.99 -		 3151 000 335		KZIZ-5 629.001/011 je nach Ausführung, mit unterschiedlicher Kupplung / depending on version, with different clutch	(85)	
			 3400 700 509 	430 10	XTend 629.001 Nabenprofil / Hub Profile: 41,1x50,8-10N je nach Ausführung, mit unterschiedlicher Kupplung / depending on version, with different clutch Nur zusammen verbauen / Only install together	(46) (85) (51)	
		OM502	 1878 080 037	430 10 430WGTZ	629.011		
			OM457LA, OM457hLA	 6594 000 079	430 430Z	für OE-Nummer / for OE number 457 030 13 05 enthält Schwungradbefestigungsschrauben / includes bolt for flywheel mounting	(83) (65)
O 580-16 RHD 629.015		OM457.944	 3400 700 509 	430 10	XTend Nabenprofil / Hub Profile: 41,1x50,8-10N Nur zusammen verbauen / Only install together	(46) (51)	
			 1863 869 028				
		OM457	 6594 000 079	430 430Z	für / for: SA 522019-08/15 enthält Schwungradbefestigungsschrauben / includes bolt for flywheel mounting	(68) (65)	
O 580-16 RHD 629.015		OM542.948	 3400 700 509 	430 10	XTend Nabenprofil / Hub Profile: 41,1x50,8-10N Nur zusammen verbauen / Only install together	(46) (51)	
			 1863 869 028				
O 580-16 RHD, O 580-17 RHD 629.012 632.005 632.007 O 580-17 RHD 632.012 629.012 O 580-17 RHD 632.005 629.012 632.007 632.012	10.99 -	OM542.966, OM542.948, OM457.944	 3482 081 233	430 MFZ430	629.012		
	10.99 -		 3151 000 335		KZIZ-5 629.012		
	10.99 -	OM457	 1878 080 034	430 10 430WGTZ	629.012		
		OM502	 1878 080 037	430 10 430WGTZ	629.012		
			OM457LA	 6594 000 079	430 430Z	für OE-Nummer / for OE number 457 030 13 05 enthält Schwungradbefestigungsschrauben / includes bolt for flywheel mounting	(83) (65)





		CODE					
---	--	------	--	--	---	---	---





MERCEDES-BENZ

O 608								
LPO 608 314.086 314.085 314.087	10.69 - 10.77	OM314		1800 125 201 ⊗ 1882 205 234 ⊗ 1861 291 136 ⊙ 3151 044 031	250 10 HBX250 250GTZ KZI-3	Mot. 410748-> 314.051-060/062-063/072/085-087		
					3151 095 043	KZI-3	->Chass. 4282707 314.051-060/062-063/072/085-087	
					3151 033 031	KZI-3	Chass. 4282708 - Mot. 410747 314.051-060/062-063/072/085-087	

O 709								
LPO 709 314.086 314.085 314.087	11.77 - 12.84	OM314		1800 125 201 ⊗ 1882 205 234 ⊗ 1861 291 136 ⊙ 3151 044 031	250 10 HBX250 250GTZ KZI-3	Mot. 678175-> 314.072/077/085-086-087		
					3151 095 043	KZI-3	->Chass. 4282707 314.072/077/085-086-087	
					3151 033 031	KZI-3	Chass. 4282708 - Mot. 678174 314.072/077/085-086-087	



O 812								
O 812 D Vario 670.373/374	01.96 -	OM602LADE		3000 725 001 ⊗ 3082 269 031 ⊗ 1864 504 031 ⊙ 3151 248 031	250 26 M250 250B KZIS-0			
					3000 951 785 ● ⊗ 3082 269 031 ⊗ 1878 600 501 ⊙ 3151 248 031	250 26 M250 250CD KZIS-0		
					2294 000 525	250 250		
		OM904LA		3400 127 701 ● ⊗ 3482 000 462 ⊗ 1878 052 842	362 18 MF362 362WG TB			
					3400 700 484 ● ⊗ 3482 000 462 ⊗ 1878 001 939	362 10 MF362 362WG TB		
					3151 000 396	KZIS-4		

O 814								
O 814, O 814 L 674.079 674.277/278	01.84 - 12.98	OM364LA		3482 008 038	310 MF310	674.079/277-278		
					1862 299 032	310 10 310WGSZ	674.079/277-278	
					3151 044 031	KZI-3	674.079/277-278	
814 O, 814 LO 674.072/073 674.272/273	01.84 - 12.98	OM366		3400 122 401 ⊗ 3482 008 038 ⊗ 1861 964 034 ⊙ 3151 044 031	310 10 MF310 310WGSZ KZI-3	674.072-073/272-273		
					3400 124 301 ⊗ 3482 012 211 ⊗ 1861 963 033 ⊙ 3151 044 031	330 10 GMF330 330WGSZ KZI-3	674.072-073/079/277-278	





O 817								
817 LO 676.464	03.96 - 12.98	OM904LA		3400 121 401 ⊗ 3482 000 462 ⊗ 1878 052 842 ⊙ 3151 000 374	362 18 MF362 362WG TB KZIS-4	676.464		
					1878 001 939 HD ●	362 18 362WG TB	676.464	
817 O, 817 LO 676.063 676.263/264	01.84 - 12.98	OM366A		3482 012 240	330 GMF330	676.063/263-264		
					1861 963 033	330 10 330WGSZ	676.063/263-264	
					3151 044 031	KZI-3	676.063/263-264	







		CODE					
---	--	------	--	--	---	---	---

MERCEDES-BENZ

O 914							
O 914 674.077		OM366		3400 122 401 ⊗ 3482 008 038 ⊗ 1861 964 034 ⊙ 3151 044 031	310 10 MF310 310WGSZ KZI-3	674.077	
					3400 124 301 ⊗ 3482 012 211 ⊗ 1861 963 033 ⊙ 3151 044 031	330 10 GMF330 330WGSZ KZI-3	674.077 Sonderausführung / Special design



O 1114							
O 1114 ,O 1114 L 675.273 675.073/074 675.274	01.84 - 12.98	OM366		3400 122 401 ⊗ 3482 008 038 ⊗ 1861 964 034 ⊙ 3151 044 031	310 10 MF310 310WGSZ KZI-3	675.073-074/273-274	







O 1117								
1117 LO 676.476	03.96 - 12.98	OM904LA		3400 121 401 ⊗ 3482 000 462 ⊗ 1878 052 842 ⊙ 3151 000 374	362 18 MF362 362WGTB KZIS-4	676.476		
					1878 001 939 HD ●	362 18 362WGTB	676.476	
1117 O,1117 LO 676.276 676.273 676.074 676.274 676.073	01.84 - 12.98	OM366.971, OM356.949, OM357.919		3482 051 131 #	350 GMF350X	676.073-074/273-274/276		
					1878 001 144	350 10 350WGTZ	676.073-074/273-274/276	
					3151 000 374	KZIS-4	676.073-074/273-274/276	

O 1120								
1120 O,1120 LO 677.074 677.273 677.276 677.275 677.073 677.274	01.84 - 12.98	OM366LA		3482 051 131 #	350 GMF350X	676.073-074/273-274 677.073-074/273-274		
					1878 001 070	350 10 350GTZ	676.073-074/273-274 677.073-074/273-274	
					3151 000 374	KZIS-4	676.073-074/273-274 677.073-074/273-274	
					1882 166 737	380 GF380	677.276	
					1878 000 105	380 10 380GTZ	677.276	
					3151 000 374	KZIS-4	677.276	

O 3500							
O 3500 ,S				1860 062 037 #	280 10 280Z		

O 5500							
O 5500				1861 034 147 #	350 10 350		























O 6600							
O 6600				1881 039 532 #	350 G350KR	Chass. 0154/54->	
					1861 034 147 #	350 10 350	

OF Series 01.83 -								
OF 1113 358.082 358.080				1882 305 131	310 GFX310	358.080/082		
					1861 303 248	310 10 310GSB	358.080/082	
					3151 095 043	KZI-3	358.080/082	
OF 1113 (358)				1861 632 032	280 10 280W2GSZ			
OF 1113 B				1882 252 331	310 GFX310			
					1861 303 248	310 10		









		CODE					
---	--	------	--	--	---	---	---

MERCEDES-BENZ

OF Series 01.83 -



















OF 1313 352.069 352.068	OM352		1882 252 331	310 GFX310	->Chass. 922885 352.068-069
			1882 305 131	310 GFX310	Chass. 922886-> 352.068-069
			1861 303 248	310 10 310GSB	352.068-069
			3151 095 043	KZI-3	352.068-069
			1882 201 132	295 GF295	
			1861 279 133	295 10 295GTZ	
OF 1317 352.089 352.088	OM327, 360		1882 234 433	350 GF350	Chass. 797910-> 352.088-089
			1878 001 074	350 10 350GTZ	352.088-089
			3151 094 041	KZI-4	352.088-089
OF 1413 352.067	OM352		1882 252 331	310 GFX310	->Chass. 922885 352.067
			1882 305 131	310 GFX310	Chass. 922886-> 352.067
			1861 303 248	310 10 310GSB	352.067
			3151 095 043	KZI-3	352.067
OF 1417 352.097	OM360		1878 001 074	350 10 350GTZ	->Chass. 797909 352.097
			3151 094 041	KZI-4	->Chass. 797909 352.097
	OM327, 360		1882 234 433	350 GF350	Chass. 797910-> 352.097
			1878 001 074	350 10 350GTZ	Chass. 797910-> 352.097
			3151 094 041	KZI-4	Chass. 797910-> 352.097
			1882 234 433	350 GF350	Chass. 797910-> 352.097
OF 1617 355.098	OM360		1878 001 074	350 10 350GTZ	
			3151 094 041	KZI-4	
			1882 166 737	380 GF380	355.099
OF 1621 355.099	OM360A		1861 470 234	380 10 380GSZ	355.099
			3151 090 131	KZI-4.5	355.099

OH-Serie

OH 1416 396.341	OM366A		3400 125 001 ● 3482 000 953 ● 1878 001 070 ● 3151 000 374	350 10 GMF350X 350GTZ KZIS-4	396.341	
OH 1417 396.346	OM366		3482 011 331 #	360 GMF360	396.346	
			3482 000 953	350 GMF350X	396.346	
			1878 001 070	350 10 350GTZ	396.346	
			3482 051 131 ● #	350 GMF350X	396.346 Nur zusammen verbauen / Only install together	(51)
			1878 001 144 ●	350 10 350WGTZ	396.346 Nur zusammen verbauen / Only install together	(51)
			3151 000 374	KZIS-4	396.346	
OH 1417 396.346	OM366A		3482 051 131 #	350 GMF350X	396.346	
			1878 001 070	350 10 350GTZ	396.346	
			3151 000 374	KZIS-4	396.346	

		CODE				
---	--	------	--	---	---	---

MERCEDES-BENZ

OH-Serie						
OH 1622 ,L 396.458 396.356 396.358 396.456	OM421		1882 302 131	380 GF380	->Chass. 6 901320 ->Chass. 5 418584 396.356/358/456/458	
			1861 923 032 #	380 10 380WGSZ	->Chass. 6 901320 ->Chass. 5 418584 396.356/358/456/458	
			3482 124 541	430 GMF430	Chass. 6 901321-> Chass. 5 418585-> 396.356/358/456/458	
			1882 301 238 ●#	420 GF420	Chass. 6 901321-> Chass. 5 418585-> 396.356/358/456/458	
			1878 003 657	420 10 420WGTZ	Chass. 6 901321-> Chass. 5 418585-> 396.356/358/456/458	
			3151 126 031	KZI-4,5	396.356/358/456/458	
OH 1625 ,L 396.476 396.376 396.478 396.378	OM422		3482 124 534	430 GMF430	396.376/378/476/478	
			1882 301 239 ●	420 GF420	396.376/378/476/478	
			1878 003 657	420 10 420WGTZ	396.376/378/476/478	
			3151 126 031	KZI-4,5	396.376/378/476/478	
OH 1627 L 396.471 396.473	OM422		3400 124 101 ● 3482 081 232 ● 1878 005 668 ○ 3151 000 549	430 10 MFZ430 430WGTZ KZISZ-5	396.471/473	
OH 1628 ,L 396.388 396.488 396.386 396.486	OM422		3482 124 534	430 GMF430	396.386/388/486/488	
			1882 301 239 ●	420 GF420	396.386/388/486/488	
			1878 003 657	420 10 420WGTZ	396.386/388/486/488	
			3151 126 031	KZI-4,5	396.386/388/486/488	
OH 1634 L 396.483	OM442A		3400 122 601 ● 3482 081 231 ● 1878 080 037 ○ 3151 000 278	430 10 MFZ430 430WGTZ KZISZ-5	->Chass. Z 902592 ->Chass. K 017131 396.483	
			3482 081 231	430 MFZ430	Chass. Z 902593-> Chass. K 017132-> 396.483	
			1878 080 037	430 10 430WGTZ	Chass. Z 902593-> Chass. K 017132-> 396.483	
			3151 000 547	KZISZ-5	Chass. Z 902593-> Chass. K 017132-> 396.483	





OP 311 - OP 330						
OP 311				1860 062 037 #	280 10 280Z	
OP 312				1861 919 134	280 10 280GTZ	
OP 315 OP 330				1881 039 532 #	350 G350KR	
				1861 034 147 #	350 10 350	

























MITSUBISHI

L 300 Bus (LO3_P/G, LO_2P) 05.80 - 02.87						
1.6 (L032P, L062P), 48 kW	09.81 - 10.86	4G32, 4G62		3000 205 001 ● 3082 833 001 ● 1878 600 827 ○ 3151 830 001	200 20 MF203K 200TB KZI-1	
1.6 (L032P, L062P), 51 kW	11.84 - 02.87					
1.8 4WD (L035G)	08.84 - 02.87					

		CODE					
---	--	------	--	--	---	---	---

MITSUBISHI

L 300 Bus (LO3_P/G, LO_2P) 05.80 - 02.87							
1.6 (L032P)	06.79 - 06.80			3082 833 001	203		
					MF203K		
				1878 600 827	200 20		
				1863 805 001	GR.1		
2.0 4WD (L037G)	11.86 - 02.87	4G63(SOHC8V)		3000 199 001 ⊗ 3082 881 001 ⊗ 1862 851 002 ⊙ 3151 831 001	215 23 MF215 215CTB KZI-1		
2.3 D (L038P)	04.83 - 10.86	4D55		3000 486 001	225 23	L038P-YNL6 / L38P-VGNL6	
				⊗ 3082 931 001 ⊗ 1862 862 002 ⊙ 3151 831 001	MF225 225CTB KZI-1		
				3000 263 001	225 23	L038P-WNL6 / L038P-WHNL6	
				⊗ 3082 931 001 ⊗ 1878 634 029 ⊙ 3151 831 001	MF225 225CPB KZI-1		

L 300 Bus (P0_W, P1_W, P2_W) 11.86 -							
1.6 (P02V, P12V)	11.86 -	4G32		3000 205 001 ⊗ 3082 833 001 ⊗ 1878 600 827 ⊙ 3151 830 001	200 20 MF203K 200TB KZI-1		
2.0 (P13V, P03W, P13T)	11.86 -	G63B, 4G63(SOHC8V)		3000 199 001 ⊗ 3082 881 001 ⊗ 1862 851 002 ⊙ 3151 831 001	215 23 MF215 215CTB KZI-1		
2.0 (P13T, P03W, P03V, P13V)	11.86 -						
2.0 4WD (P13V, P23V, P23W, P03V, P13T)	12.86 -	4G63(SOHC8V)		3000 486 001 ⊗ 3082 931 001 ⊗ 1862 862 002 ⊙ 3151 831 001	225 23 MF225 225CTB KZI-1		
2.0 4WD (P13V, P23W, P03V, P13T)	11.86 -						
2.4 4WD (P24W, P24V), 80 kW	11.86 - 12.90	G64B		3082 931 001	225		
					MF225		
				1862 862 002	225 23		
				3151 831 001	225CTB KZI-1		
				6283 600 156		08.1987->	
				6284 600 160 ▲			
2.4 4WD (P24W, P24V), 82 kW	11.90 -	4G64(12V)		3082 931 001	225		
					MF225		
				1862 862 002	225 23		
				3151 831 001	225CTB KZI-1		
				6283 600 156		->06.1995	
				6284 600 160 ▲		->06.1995	
2.4 (P04W, P14V, P04V)	11.90 -	4G64(12V)		3082 931 001	225		
					MF225		
				1862 862 002	225 23		
				3151 831 001	225CTB KZI-1		
				6283 600 156			
				6284 600 160 ▲			
2.5 D (P25V, P05W, P05V, P15V, P15T)	11.86 -	4D56(8V)		3000 951 422 ⊗ 3082 931 001 ⊗ 1878 634 029 ⊙ 3151 600 525	225 23 MF225 225CPB KZIS-1		
				6283 600 156			
				6284 600 160 ▲			
2.5 TD 4WD (P25W, P25V)	11.88 -	4D56T		3000 264 001 ⊗ 3082 936 001 ⊗ 1878 634 029 ⊙ 3151 600 525	225 23 MF225 225CPB KZIS-1		
				6283 600 156			
				6284 600 160 ▲			



















		CODE				
---	--	------	--	---	---	---

NEOPLAN

Centroliner 10.98 -

Centroliner N 4426/3L	D2866LOH, 265kw, D2866LOH, 301kw	 6594 000 124	430 430Z	Getr. / GBox: ZF 5 HP 602 enthält Schwungradbefestigungsschrauben / includes bolt for flywheel mounting (65)
		 3482 083 032	430 MFZ430	Getr. / GBox: ZF 5 HP 602
		 1878 085 641	430 10 430GTZ	Getr. / GBox: ZF 5 HP 602
		 3151 000 157	KZISZ-5	Getr. / GBox: ZF 5 HP 602















Cityliner 04.73 -

Cityliner	DAFDKT1160	 3482 124 550	430 GMF430	
		 3482 006 036 ●#	420 GTF420	
	MAND2538MTA	 3482 124 534	430 GMF430	
		 1882 301 239 ●	420 GF420	
		 1878 001 138	420 10 420GTZ	
	MAND2866LXO H	 1882 342 134	420 GF420X	
		 1878 003 657	420 10 420WGTZ	
		 3151 119 001	KZI-4,5	
	OM402LA	 1888 055 247	380 GF2/380	enthält eine Kupplungsscheibe / This part number includes one clutch disc (66)
		 1862 123 131 ▽	380 10 380GV	Lose Kupplungsscheibe / Loose clutch disc (39)
		 3151 186 001	KZI-4,5	
		 1882 349 003	380 GF2/380	In 1888 enthalten / Contained in 1888 (29)
		 1859 250 100	380 GF2/380	In 1888 enthalten / Contained in 1888 (29)
		 1862 122 132 △	380 10 380GVZ	In 1888 enthalten / Contained in 1888 (29)
Cityliner N 1116	D2866LOH, 301kw, D2876LOH, 338kw	 6594 000 124	430 430Z	Getr. / GBox: ZF 8S-180 Getr. / GBox: ZF AS-Tronic enthält Schwungradbefestigungsschrauben / includes bolt for flywheel mounting (65)
		 3482 083 032	430 MFZ430	Getr. / GBox: ZF 8S-180 Getr. / GBox: ZF AS-Tronic
		 1878 085 641	430 10 430GTZ	Getr. / GBox: ZF 8S-180 Getr. / GBox: ZF AS-Tronic
		 3151 000 157	KZISZ-5	Getr. / GBox: ZF 8S-180 Getr. / GBox: ZF AS-Tronic

		CODE				
---	--	------	--	---	---	---

NEOPLAN

Cityliner 04.73 -

N 1216 HD N 1217 HD N 1218 HD	09.06 -	D2066LOH07/0 8/10/28, D2066LUH09/2 4/34		3400 700 505 ■	430 10	XTend Getr. / GBox: ZF 6S Nabenprofil / Hub Profile: 41,1x50,8-10N Nur zusammen verbauen / Only install together	(46) (51)
		D2066LOH07/0 8/10/28, D2066LUH09/2 4/34, D2676LOH10/2 6		3400 700 511 ◐■	430 10	XTend Getr. / GBox: GO 210-6 Nabenprofil / Hub Profile: 41,1x50,8-10N Nur zusammen verbauen / Only install together	(46) (51)
		D2066LOH07/0 8/10, D2066LOH28/3 2, D2676LOH10/2 6/30		3482 083 032	430 MFZ430	Getr. / GBox: GO 210-6	
				1878 080 037	430 10 430WGTZ	Getr. / GBox: GO 210-6	
				3151 000 335	KZISZ-5	Getr. / GBox: GO 210-6	
		D2066LOH07/0 8/10, D2066LOH28/3 2, D2066LUH09/2 4/34/53, D2676LOH10/2 6/30		3400 700 381 ⊗ 3482 000 361 ⊗ 1878 080 037 ⊙ 3151 000 493	430 10 MFZ430 430WGTZ KZISZ-5	Getr. / GBox: AS-Tronic für Ausrückgabel mit Rollen / for release fork with rollers	(70)
				3482 000 361	430 MFZ430	Getr. / GBox: AS-Tronic für Ausrückgabel mit Nocken / for release fork with cams	(69)
				1878 080 037	430 10 430WGTZ	Getr. / GBox: AS-Tronic für Ausrückgabel mit Nocken / for release fork with cams	(69)
				3151 000 144	KZISZ-5	Getr. / GBox: AS-Tronic für Ausrückgabel mit Nocken / for release fork with cams	(69)
		D2066LOH07/0 8/28, D2676LOH26		6594 000 121	430 430Z	Getr. / GBox: GO 210-6 enthält Schwungradbefestigungsschrauben / includes bolt for flywheel mounting	(65)
D2066LOH07/2 8		6594 000 121	430 430Z	Getr. / GBox: ZF 6S enthält Schwungradbefestigungsschrauben / includes bolt for flywheel mounting	(65)		
D2066LOH03		1863 869 038					
N 1216 HDC	09.06 -	D2066LUH03/0 4/10, D2066LUH14/1 5/09, D2676LOH01/1 0		3400 700 510 ■	430 10	XTend Getr. / GBox: ZF 6S-85 Nabenprofil / Hub Profile: 38,2x44,5-10N Nur zusammen verbauen / Only install together	(46) (51)
				3400 700 509 ■	430 10	XTend Getr. / GBox: GO-210-6 Nabenprofil / Hub Profile: 41,1x50,8-10N Nur zusammen verbauen / Only install together	(46) (51)
				3400 700 450 ⊗ 3482 000 361 ⊗ 1878 004 832 ⊙ 3151 000 493	430 10 MFZ430 430WGTZ KZISZ-5	Getr. / GBox: AS-Tronic für Ausrückgabel mit Rollen / for release fork with rollers	(70)
				3400 700 403 ⊗ 3482 000 361 ⊗ 1878 004 832 ⊙ 3151 000 144	430 10 MFZ430 430WGTZ KZISZ-5	Getr. / GBox: AS-Tronic für Ausrückgabel mit Nocken / for release fork with cams	(69)
		D2676LOH02		3400 700 459 HD ⊗ 3482 000 246 ⊗ 1878 004 104 ⊙ 3151 000 493	430 10 MFZ430 430WGTZ KZISZ-5	Getr. / GBox: AS-Tronic für Ausrückgabel mit Rollen / for release fork with rollers	(70)

Clubstar

Clubstar		OM366		3400 122 401 ⊗ 3482 008 038 ⊗ 1861 964 034 ⊙ 3151 044 031	310 10 MF310 310WGSZ KZI-3	
----------	--	-------	---	--	--	--











Euroliner 10.98 -

N 3312 K / U N 3313 U		OM501LA		6594 000 080	430 430Z	Getr. / GBox: ZF 6S-1600 Getr. / GBox: ZF 5 HP 602 C enthält Schwungradbefestigungsschrauben / includes bolt for flywheel mounting	(65)
				3482 083 032	430 MFZ430	Getr. / GBox: ZF 6S-1600 Getr. / GBox: ZF 5 HP 602 C	
				1878 085 641	430 10 430GTZ	Getr. / GBox: ZF 6S-1600 Getr. / GBox: ZF 5 HP 602 C	
				3151 000 157	KZISZ-5	Getr. / GBox: ZF 6S-1600 Getr. / GBox: ZF 5 HP 602 C	





















		CODE				
---	--	------	--	---	---	---

NEOPLAN

Euroliner 10.98 -

N 3316 KL, N 3316 ÜL	D2866LUH25, 265kw		 6594 000 124	430 430Z	Getr. / GBox: ZF 6S-1600 Getr. / GBox: ZF 5HP-602 Getr. / GBox: ZF AS-Tronic enthält Schwungradbefestigungsschrauben / includes bolt for flywheel mounting (65)
			 3482 083 032	430 MFZ430	Getr. / GBox: ZF 6S-1600 Getr. / GBox: ZF 5HP-602 Getr. / GBox: ZF AS-Tronic
			 1878 085 641	430 10 430GTZ	Getr. / GBox: ZF 6S-1600 Getr. / GBox: ZF 5HP-602 Getr. / GBox: ZF AS-Tronic
			 3151 000 157	KZISZ-5	Getr. / GBox: ZF 6S-1600 Getr. / GBox: ZF 5HP-602 Getr. / GBox: ZF AS-Tronic
N 3316 Ü, N 3316 K	D2866LUH30, 301kw		 6594 000 124	430 430Z	Getr. / GBox: ZF 8S-180 Getr. / GBox: ZF AS-Tronic enthält Schwungradbefestigungsschrauben / includes bolt for flywheel mounting (65)
			 3482 083 032	430 MFZ430	Getr. / GBox: ZF 8S-180 Getr. / GBox: ZF AS-Tronic
			 1878 085 641	430 10 430GTZ	Getr. / GBox: ZF 8S-180 Getr. / GBox: ZF AS-Tronic
			 3151 000 157	KZISZ-5	Getr. / GBox: ZF 8S-180 Getr. / GBox: ZF AS-Tronic











Jetliner 09.73 - 09.93

Jetliner	DAFDKT1160		 3482 124 550	430 GMF430	
			 3482 006 036 ●#	420 GTF420	
			 3482 124 534	430 GMF430	
			 1882 301 239 ●	420 GF420	
N 209 Jetliner N 212 Jetliner	D2066LOH07/0 8/10, D2066LOH28/3 2, D2066LUH09/2 4/34/53, D2676LOH10/2 6/30		 3400 700 381	430 10 MFZ430	Getr. / GBox: AS-Tronic für Ausrückgabel mit Rollen / for release fork with rollers (70)
			 3482 000 361	430 MFZ430	Getr. / GBox: AS-Tronic für Ausrückgabel mit Nocken / for release fork with cams (69)
			 1878 080 037	430 10 430WGTZ	Getr. / GBox: AS-Tronic für Ausrückgabel mit Nocken / for release fork with cams (69)
			 3151 000 144	KZISZ-5	Getr. / GBox: AS-Tronic für Ausrückgabel mit Nocken / for release fork with cams (69)
N 209 Jetliner N 212 Jetliner	D2066LOH06/1 2/27/31, D2066LUH07/0 8/22/23, D2066LUH32/3 3/47/48, D2066LUH51/5 2		 3482 000 361	430 MFZ430	Getr. / GBox: AS-Tronic für Ausrückgabel mit Rollen / for release fork with rollers (70)
			 1878 080 034	430 10 430WGTZ	Getr. / GBox: AS-Tronic für Ausrückgabel mit Rollen / for release fork with rollers (70)
			 3151 000 493	KZISZ-5	Getr. / GBox: AS-Tronic für Ausrückgabel mit Rollen / for release fork with rollers (70)
			 3482 000 361	430 MFZ430	Getr. / GBox: AS-Tronic für Ausrückgabel mit Nocken / for release fork with cams (69)
N 209 Jetliner N 212 Jetliner	D2066LOH06/1 2/27/31, D2066LUH07/0 8/22/23, D2066LUH32/3 3/47/48, D2066LUH51/5 2		 1878 080 034	430 10 430WGTZ	Getr. / GBox: AS-Tronic für Ausrückgabel mit Nocken / for release fork with cams (69)
			 3151 000 144	KZISZ-5	Getr. / GBox: AS-Tronic für Ausrückgabel mit Nocken / for release fork with cams (69)
			 1863 869 038		



















		CODE				
---	--	------	--	---	---	---

NEOPLAN

Megaliner 01.93 -











Megaliner	DAFDKT1160		3482 124 550	430 GMF430		
			3482 006 036 ●#	420 GTF420		
	MAND2866LXOH		1882 342 134	420 GF420X		
			1878 003 657	420 10 420WGTZ		
			3151 119 001	KZI-4,5		
	OM442LA		3488 017 410	400 MFZ2/400X	enthält eine Kupplungsscheibe / This part number includes one clutch disc	(66)
			1878 634 022 ▽#	400 10 400GVZ		
			1878 005 805 ▽	400 10 400GTZ		
			3151 000 157	KZISZ-5		
			1878 634 023 △#	400 10 400GVZ		
			1878 005 805 △	400 10 400GTZ		



















Motoren

Motor / Engine - DAF	DKA1160		1861 206 211 #	420 10 420GS		
			3482 124 550	430 GMF430		
	DKT1160		3482 006 036 ●#	420 GTF420		
Motor / Engine - Daimler Chrysler	OM402		1882 302 131	380 GF380	Je nach Kundenwunsch mit unterschiedlicher Kupplung / Equipped with different clutch according to customer requirement	(33)
			1878 001 152	380 10 380WGTZ		
			3482 124 534	430 GMF430	Je nach Kundenwunsch mit unterschiedlicher Kupplung / Equipped with different clutch according to customer requirement	(33)
			1882 301 239 ●	420 GF420	Je nach Kundenwunsch mit unterschiedlicher Kupplung / Equipped with different clutch according to customer requirement	(33)
			1878 002 706	420 10 420GTZ		
	OM407		3482 124 541	430 GMF430		
			1882 301 238 ●#	420 GF420		
			1878 001 136	420 10 420GTZ		
	OM421		1882 302 131	380 GF380		
			1878 000 105	380 10 380GTZ		
			1878 001 152 ●	380 10 380WGTZ		
	OM457HLA		6594 000 079	430 430Z	Getr. / GBox: 8 S 180; 10 AS 2301 Getr. / GBox: GO 190/210 für OE-Nummer / for OE number 457 030 13 05 enthält Schwungradbefestigungsschrauben / includes bolt for flywheel mounting	(83) (65)
OM501LA, OM502LA		6594 000 080	430 430Z	Getr. / GBox: 8 S 180; 10 AS 2301 für OE-Nummer / for OE number 541 030 03 05 enthält Schwungradbefestigungsschrauben / includes bolt for flywheel mounting	(83) (65)	
Motor / Engine - Henschel	561-17, 562-18		1881 039 531 #	350 G350		
	523-23		1861 206 211 #	420 10 420GS		

		CODE					
---	--	------	--	--	---	---	---

NEOPLAN















Motoren							
Motor / Engine - MAN	D2530MH, D2538MTH		3482 124 534	430 GMF430			
			1882 301 239 ●	420 GF420			
			1878 002 706	420 10 420GTZ			
	D2538MH		1882 302 131	380 GF380			
			1878 001 152	380 10 380WGTZ			
	D2566MTH		3482 124 550	430 GMF430			
			3482 006 036 ●#	420 GTF420			
			1878 002 706	420 10 420GTZ			
			1878 003 657 ●	420 10 420WGTZ			
	D2866LOH24, D2866LOH25, D2866LOH28, D2866LOH29, D2866LUH, D2876LOH, D2876LOH02, D2876LUH		6594 000 124	430 430Z	Getr. / GBox: 8 S 180; 10 AS 2301 für OE-Nummer / for OE number 11068877 enthält Schwungradbefestigungsschrauben / includes bolt for flywheel mounting		(83) (65)

N 113 - N 116							
N 113	OM402LA, 442LA		3400 700 379 ● 3482 083 032 ● 1878 004 832 ◦ 3151 000 157	430 10 MFZ430 430WGTZ KZISZ-5			
			3482 083 118	430 MFZ430			
	OM441LA		1878 004 832	430 10 430WGTZ			
			3151 000 157	KZISZ-5			
N 116	OM403		1800 125 301 ● 1882 301 239 ● 1878 002 706 ◦ 3151 000 375	420 10 GF420 420GTZ KZIS-4			
			3482 124 534	430 GMF430			
			1878 003 657	420 10 420WGTZ			
			3151 000 375	KZIS-4			
	OM422A		1882 342 134	420 GF420X			
N 116	OM403		3482 124 516	430 GMF430			
			1878 002 706	420 10 420GTZ			
			1878 003 657 ●	420 10 420WGTZ			
N 116	OM402LA, 442LA		3400 700 379 ● 3482 083 032 ● 1878 004 832 ◦ 3151 000 157	430 10 MFZ430 430WGTZ KZISZ-5			
N 116	OM442LA		3488 017 410	400 MFZ2/400X	enthält eine Kupplungsscheibe / This part number includes one clutch disc	(66)	
			1878 634 022 ▽#	400 10 400GVZ			
			1878 005 805 ▽	400 10 400GTZ			
			3151 000 157	KZISZ-5			
			1878 005 805 △	400 10 400GTZ			
			1878 634 023 △#	400 10 400GVZ			















		CODE					
---	--	------	--	--	---	---	---

NEOPLAN

N 113 - N 116

N 116	BF6M1015C, D2876LOH01, MAND2866LOH 23		3400 700 379 ⊗ 3482 083 032 ⊗ 1878 004 832 ◊ 3151 000 157	430 10 MFZ430 430WGTZ KZISZ-5				
	DAFDKA1160V		1861 206 211 #	420 10 420GS				
	HS6R1315-524- 24		1861 206 211 #	420 10 420GS				
	OM422		1800 125 301 ⊗ 1882 301 239 ⊗ 1878 002 706 ◊ 3151 000 375	420 10 GF420 420GTZ KZIS-4				
						3482 124 534	430 GMF430	
						1878 003 657	420 10 420WGTZ	
						3151 000 375	KZIS-4	
	OM442A		3482 119 031	430 GMF430				
						3482 018 132 ●#	420 GMF420	
						1878 086 941	420 10 420WGTZ	
						3151 202 002	KZI-4,5	
	MAND2566MTH		3482 124 534	430 GMF430				
						1882 301 239 ●	420 GF420	
						1878 001 138	420 10 420GTZ	













N 117 - N 120

N 117 N 120	OM403		1800 125 301 ⊗ 1882 301 239 ⊗ 1878 002 706 ◊ 3151 000 375	420 10 GF420 420GTZ KZIS-4				
						3482 124 534	430 GMF430	
						1878 003 657	420 10 420WGTZ	
						3151 000 375	KZIS-4	
N 117 N 120	OM403		3482 124 516	430 GMF430				
						1878 002 706	420 10 420GTZ	
						1878 003 657 ●	420 10 420WGTZ	
N 117 N 118	OM442LA		3400 700 379 ⊗ 3482 083 032 ⊗ 1878 004 832 ◊ 3151 000 157	430 10 MFZ430 430WGTZ KZISZ-5				
						3488 017 410	400 MFZ2/400X	enthält eine Kupplungsscheibe / This part number includes one clutch disc (66)
N 117 N 118	OM442LA		1878 634 022 ▽#	400 10 400GVZ				
						1878 005 805 ▽	400 10 400GTZ	
						3151 000 157	KZISZ-5	
						1878 005 805 △	400 10 400GTZ	
						1878 634 023 △#	400 10 400GVZ	











		CODE		 Parameter		
---	--	------	--	---	---	---

NEOPLAN

N 117 - N 120

N 117	D2876LOH01, MAND2866LOH 23	 3400 700 379 ⊗ 3482 083 032 ⊗ 1878 004 832 ⊙ 3151 000 157	430 10 MFZ430 430WGTZ KZISZ-5		
	OM422A	 1882 342 134	420 GF420X		
		 1878 003 657	420 10 420WGTZ		
	OM442A	 3482 119 031	430 GMF430		
		 3482 018 132 ●#	420 GMF420		
		 1878 086 941	420 10 420WGTZ		
 3151 202 002		KZI-4,5			
N 118	D2876LOH01, MAND2866LOH 23	 3400 700 379 ⊗ 3482 083 032 ⊗ 1878 004 832 ⊙ 3151 000 157	430 10 MFZ430 430WGTZ KZISZ-5		
	OM442A	 3482 119 031	430 GMF430		
		 3482 018 132 ●#	420 GMF420		
		 1878 086 941	420 10 420WGTZ		
		 3151 202 002	KZI-4,5		















N 121 - N 128

N 121 N 122	OM403	 1800 125 301 ⊗ 1882 301 239 ⊗ 1878 002 706 ⊙ 3151 000 375	420 10 GF420 420GTZ KZIS-4		
		 3482 124 534	430 GMF430		
		 1878 003 657	420 10 420WGTZ		
		 3151 000 375	KZIS-4		
N 121 N 122	OM403	 3482 124 516	430 GMF430		
		 1878 002 706	420 10 420GTZ		
		1878 003 657 ●	420 10 420WGTZ		
N 122	OM442LA	 3400 700 379 ⊗ 3482 083 032 ⊗ 1878 004 832 ⊙ 3151 000 157	430 10 MFZ430 430WGTZ KZISZ-5		
N 122	OM442LA	 3488 017 410	400 MFZ2/400X	enthält eine Kupplungsscheibe / This part number includes one clutch disc	(66)
		 1878 634 022 ▽#	400 10 400GVZ		
		1878 005 805 ▽	400 10 400GTZ		
		 3151 000 157	KZISZ-5		
		 1878 005 805 △	400 10 400GTZ		
		1878 634 023 △#	400 10 400GVZ		





		CODE					
---	--	------	--	--	---	---	---

NEOPLAN



N 121 - N 128

N 122	BF6M1015C, D2876LOH01, MAND2866LOH 23		3400 700 379  3482 083 032  1878 004 832  3151 000 157	430 10 MFZ430 430WGTZ KZISZ-5				
	DAFDKA1160V		1861 206 211 #	420 10 420GS				
	HS6R1315-524- 24		1861 206 211 #	420 10 420GS				
	OM423			3482 124 516	430 GMF430			
					1878 002 706	420 10 420GTZ		
					1878 003 657 ●	420 10 420WGTZ		
	OM442			1888 055 247	380 GF2/380	enthält eine Kupplungsscheibe / This part number includes one clutch disc	(66)	
					1862 123 131 ▽	380 10 380GV	Lose Kupplungsscheibe / Loose clutch disc	(39)
					3151 186 001	KZI-4,5		
					1882 349 003	380 GF2/380	In 1888 enthalten / Contained in 1888	(29)
					1859 250 100	380 GF2/380	In 1888 enthalten / Contained in 1888	(29)
				1862 122 132 △	380 10 380GVZ	In 1888 enthalten / Contained in 1888	(29)	

N 138 - N 140

N 138		OM403		3482 124 516	430 GMF430	
				1878 002 706	420 10 420GTZ	
				1878 003 657 ●	420 10 420WGTZ	
N 138		OM404		1882 342 134	420 GF420X	
				1878 003 657	420 10 420WGTZ	



























N 202 - N 209

N 202		MAN0226MC		3482 060 233	350 MF350	
				1861 777 041 #	350 10 350GTD	



		CODE				
---	--	------	--	---	---	---

NEOPLAN

N 202 - N 209

N 208	MAND0226MC	 3482 060 233	350 MF350		
		 1861 777 037	350 10 350GTD		
		 3151 199 001	KZIS-3		
	OM366LA	 3482 000 463	395 MF395		
		 1862 506 131	395 10 395WGTZ		
		 3151 202 002	KZI-4,5		
	OM352	 1882 252 331	310 GFX310		
		 1861 303 248	310 10 310GSB		
	OM366	 3482 002 234	350 GMF350X		
		 1878 001 077	350 10 350GTZ		
		 3151 068 101	KZI-3		
	MAND0826LOH 17, 18	 3482 000 463	395 MF395		
		 1862 506 131	395 10 395WGTZ		
		 3151 000 419	KZIS-4		
	N 209	OM401	 1882 311 131 #	350 GF350	Je nach Kundenwunsch mit unterschiedlicher Kupplung / Equipped with different clutch according to customer requirement
 1878 001 070			350 10 350GTZ		
 3482 124 534			430 GMF430	Je nach Kundenwunsch mit unterschiedlicher Kupplung / Equipped with different clutch according to customer requirement	(33)
 1882 301 239 ●			420 GF420	Je nach Kundenwunsch mit unterschiedlicher Kupplung / Equipped with different clutch according to customer requirement	(33)
 1878 002 706			420 10 420GTZ		
OM422		 1800 125 301	420 10 GF420		
		 1882 301 239	420GTZ		
		 1878 002 706	KZIS-4		
		 3151 000 375			
 3482 124 534	430 GMF430				
 1878 003 657	420 10 420WGTZ				
 3151 000 375	KZIS-4				

N 210 - N 213

N 210	OM352	 1882 252 331	310 GFX310		
		 1861 303 248	310 10 310GSB		



CODE



Parameter









































NEOPLAN

N 210 - N 213

N 210							
N 212	HS6R1112-562-18		1881 039 531 #	350 G350			
			1878 001 074	350 10 350GTZ			
	OM352		1882 252 331	310 GFX310			
			1861 303 248	310 10 310GSB			
	OM401		1882 311 131 #	350 GF350	Je nach Kundenwunsch mit unterschiedlicher Kupplung / Equipped with different clutch according to customer requirement	(33)	
			1878 001 070	350 10 350GTZ			
			3482 124 534	430 GMF430	Je nach Kundenwunsch mit unterschiedlicher Kupplung / Equipped with different clutch according to customer requirement	(33)	
			1882 301 239 ●	420 GF420	Je nach Kundenwunsch mit unterschiedlicher Kupplung / Equipped with different clutch according to customer requirement	(33)	
			1878 002 706	420 10 420GTZ			
	OM422		1800 125 301	420 10 GF420			
			● 1882 301 239	420GTZ			
			● 1878 002 706	KZIS-4			
			◦ 3151 000 375				
			3482 124 534	430 GMF430			
	OM441LA		1878 003 657	420 10 420WGTZ			
			3151 000 375	KZIS-4			
			3482 083 118	430 MFZ430			
			1878 004 832	430 10 430WGTZ			
		3151 000 157	KZISZ-5				
N 213	HS6R1112-562-18		1881 039 531 #	350 G350			
			1878 001 074	350 10 350GTZ			
	OM401		1882 311 131 #	350 GF350	Je nach Kundenwunsch mit unterschiedlicher Kupplung / Equipped with different clutch according to customer requirement	(33)	
			1878 001 070	350 10 350GTZ			
			3482 124 534	430 GMF430	Je nach Kundenwunsch mit unterschiedlicher Kupplung / Equipped with different clutch according to customer requirement	(33)	
			1882 301 239 ●	420 GF420	Je nach Kundenwunsch mit unterschiedlicher Kupplung / Equipped with different clutch according to customer requirement	(33)	
			1878 002 706	420 10 420GTZ			
	OM422		1800 125 301	420 10 GF420			
			● 1882 301 239	420GTZ			
			● 1878 002 706	KZIS-4			
			◦ 3151 000 375				
			3482 124 534	430 GMF430			
	OM441LA		1878 003 657	420 10 420WGTZ			
			3151 000 375	KZIS-4			
			3482 083 118	430 MFZ430			
			1878 004 832	430 10 430WGTZ			
			3151 000 157	KZISZ-5			

		CODE				
---	--	------	--	---	---	---





































NEOPLAN

N 214 - N 216							
N 214	OM422	 1800 125 301  1882 301 239  1878 002 706  3151 000 375	420 10 GF420 420GTZ KZIS-4				
		 3482 124 534	430 GMF430				
		 1878 003 657	420 10 420WGTZ				
		 3151 000 375	KZIS-4				
N 214	OM403	 1800 125 301  1882 301 239  1878 002 706  3151 000 375	420 10 GF420 420GTZ KZIS-4				
		 3482 124 534	430 GMF430				
		 1878 003 657	420 10 420WGTZ				
		 3151 000 375	KZIS-4				
		OM422A	 1882 342 134	420 GF420X			
N 214	DAFDKA1160V	 1861 206 211 #	420 10 420GS				
	HS6R1112-562-18	 1881 039 531 #	350 G350				
		 1878 001 074	350 10 350GTZ				
	D2876LOH01, MAND2866LOH 23	 3400 700 379  3482 083 032  1878 004 832  3151 000 157	430 10 MFZ430 430WGTZ KZISZ-5				
		MAND2866LOH 26	 3482 062 035	430 GMFZ430			
			 1878 080 034	430 10 430WGTZ			
	 3151 000 157		KZISZ-5				
	OM441LA	 3482 083 118	430 MFZ430				
		 1878 004 832	430 10 430WGTZ				
		 3151 000 157	KZISZ-5				
	OM442LA	 3482 083 032	430 MFZ430				
 1878 004 832		430 10 430WGTZ					
 3151 000 157		KZISZ-5					
N 216	OM422	 1800 125 301  1882 301 239  1878 002 706  3151 000 375	420 10 GF420 420GTZ KZIS-4				
		 3482 124 534	430 GMF430				
		 1878 003 657	420 10 420WGTZ				
		 3151 000 375	KZIS-4				

		CODE		 Parameter		
---	--	------	--	---	---	---

NEOPLAN



















N 214 - N 216

N 216		OM422	 1800 125 301  1882 301 239  1878 002 706  3151 000 375	420 10 GF420 420GTZ KZIS-4				
			 3482 124 534 ●	430 GMF430				
			 1878 003 657 ●	420 10 420WGTZ				
			 3151 000 375	KZIS-4				
		OM403	 3482 124 516	430 GMF430				
			 1878 002 706	420 10 420GTZ				
			 1878 003 657 ●	420 10 420WGTZ				
		OM422A	 1882 342 134	420 GF420X				
		N 216		OM402LA	 3400 700 379  3482 083 032  1878 004 832  3151 000 157	430 10 MFZ430 430WGTZ KZISZ-5		
		N 216		DAFDKA1160V	 1861 206 211 #	420 10 420GS		
HS6R1315-524-24	 1861 206 211 #			420 10 420GS				
MAND2566MTH	 3482 124 534			430 GMF430				
	 1882 301 239 ●			420 GF420				
	 1878 001 138			420 10 420GTZ				
D2876LOH01, MAND2866LOH 23	 3400 700 379  3482 083 032  1878 004 832  3151 000 157			430 10 MFZ430 430WGTZ KZISZ-5				
MAND2866LOH 26	 3482 062 035			430 GMFZ430				
	 1878 080 034			430 10 430WGTZ				
	 3151 000 157			KZISZ-5				
F10L413	 3482 124 534			430 GMF430				
	 1882 301 239 ●			420 GF420				
	 1861 410 047 #			420 10 420/ 210GSZ				
OM441LA	 3482 083 118			430 MFZ430				
	 1878 004 832			430 10 430WGTZ				
	 3151 000 157			KZISZ-5				
OM442LA	 3482 083 032			430 MFZ430				
	 1878 004 832	430 10 430WGTZ						
	 3151 000 157	KZISZ-5						













		CODE				
---	--	------	--	---	---	---

NEOPLAN

N 218 - N 220

N 218		OM422	 1800 125 301	420 10		
			 1882 301 239	GF420		
			 1878 002 706	420GTZ		
			 3151 000 375	KZIS-4		
			 3482 124 534	430		
				GMF430		
			 1878 003 657	420 10		
				420WGTZ		
			 3151 000 375	KZIS-4		
N 218 N 220		OM403	 1800 125 301	420 10		
			 1882 301 239	GF420		
			 1878 002 706	420GTZ		
			 3151 000 375	KZIS-4		
			 3482 124 534	430		
				GMF430		
			 1878 003 657	420 10		
				420WGTZ		
			 3151 000 375	KZIS-4		
		OM422A	 1882 342 134	420		
				GF420X		
N 218 N 220		OM403	 3482 124 516	430		
				GMF430		
			 1878 002 706	420 10		
				420GTZ		
			 1878 003 657 ●	420 10		
				420WGTZ		
N 218		HS6R1315-524-24	 1861 206 211 #	420 10		
				420GS		









































N 312 - N 314

N 312		HS6R1112-562-18	 1881 039 531 #	350				
				G350				
			 1878 001 074	350 10				
				350GTZ				
			OM352	 1882 252 331	310			
					GFX310			
			 1861 303 248	310 10				
				310GSB				
		OM441LA	 3482 083 118	430				
				MFZ430				
			 1878 004 832	430 10				
				430WGTZ				
			 3151 000 157	KZISZ-5				
N 313		OM401	 1882 311 131 #	350	Je nach Kundenwunsch mit unterschiedlicher Kupplung / Equipped with different clutch according to customer requirement	(33)		
				GF350				
			 1878 001 070	350 10				
				350GTZ				
			 3482 124 534	430	Je nach Kundenwunsch mit unterschiedlicher Kupplung / Equipped with different clutch according to customer requirement	(33)		
		GMF430						
			 1882 301 239 ●	420	Je nach Kundenwunsch mit unterschiedlicher Kupplung / Equipped with different clutch according to customer requirement	(33)		
				GF420				
			 1878 002 706	420 10				
				420GTZ				

		CODE		 Parameter		
---	--	------	--	---	---	---

NEOPLAN

N 312 - N 314

N 313	HS6R1112-562-18	 1881 039 531 #	350 G350			
		 1878 001 074	350 10 350GTZ			
	OM422	 1800 125 301  1882 301 239  1878 002 706  3151 000 375	420 10 GF420 420GTZ KZIS-4			
		 3482 124 534	430 GMF430			
		 1878 003 657	420 10 420WGTZ			
		 3151 000 375	KZIS-4			
N 314	DAFDKA1160V	 1861 206 211 #	420 10 420GS			
	HS6R1112-562-18	 1881 039 531 #	350 G350			
		 1878 001 074	350 10 350GTZ			
	D2866LUH20, 21, MAND2866LOH 25, 26	 3482 062 035	430 GMFZ430			
		 1878 080 034	430 10 430WGTZ			
		 3151 000 157	KZISZ-5			
	OM441LA	 3482 083 118	430 MFZ430			
		 1878 004 832	430 10 430WGTZ			
		 3151 000 157	KZISZ-5			
	OM442LA	 3400 700 379  3482 083 032  1878 004 832  3151 000 157	430 10 MFZ430 430WGTZ KZISZ-5			
		OM447hLA	 3482 083 118	430 MFZ430		
			 1878 085 742	430 10 430WGTZ		
	 3151 000 157		KZISZ-5			
	N 314	OM422	 1800 125 301  1882 301 239  1878 002 706  3151 000 375	420 10 GF420 420GTZ KZIS-4		
			 3482 124 534	430 GMF430		
 1878 003 657			420 10 420WGTZ			
 3151 000 375			KZIS-4			
N 314			OM403	 1800 125 301  1882 301 239  1878 002 706  3151 000 375	420 10 GF420 420GTZ KZIS-4	
	 3482 124 534	430 GMF430				
	 1878 003 657	420 10 420WGTZ				
	 3151 000 375	KZIS-4				
	OM422A	 1882 342 134	420 GF420X			



CODE



Parameter



































NEOPLAN

N 316 - N 318

N 316	DAFDKA1160V		1861 206 211 #	420 10 420GS	
	HS6R1315-524-24		1861 206 211 #	420 10 420GS	
	DBOM401LA, MAND2865LUH 05		3482 083 118	430 MFZ430	
			1878 085 742	430 10 430WGTZ	
	MAND2865LOH , LUH07		3482 083 118	430 MFZ430	
			1878 004 832	430 10 430WGTZ	
			3151 000 157	KZISZ-5	
	D2866LOH25, 26, D2866LUH20, 21, D2876LUH01		3482 062 035	430 GMFZ430	
			1878 080 034	430 10 430WGTZ	
			3151 000 157	KZISZ-5	
	D2876LOH01, MAND2866LOH 23		3400 700 379 ⊗ 3482 083 032 ⊗ 1878 004 832 ◦ 3151 000 157	430 10 MFZ430 430WGTZ KZISZ-5	
			3482 083 118	430 MFZ430	
			1878 004 832	430 10 430WGTZ	
			3151 000 157	KZISZ-5	
	OM441LA		3482 083 118	430 MFZ430	
			1878 004 832	430 10 430WGTZ	
			3151 000 157	KZISZ-5	
	OM442		1800 125 301 ⊗ 1882 301 239 ⊗ 1878 002 706 ◦ 3151 000 375	420 10 GF420 420GTZ KZIS-4	
			3482 124 534 ●	430 GMF430	
	OM447HLA		3482 083 118	430 MFZ430	
		1878 085 742	430 10 430WGTZ		
		3151 000 157	KZISZ-5		
N 316	OM422		1800 125 301 ⊗ 1882 301 239 ⊗ 1878 002 706 ◦ 3151 000 375	420 10 GF420 420GTZ KZIS-4	
			3482 124 534	430 GMF430	
			1878 003 657	420 10 420WGTZ	
			3151 000 375	KZIS-4	
N 316	OM403		1800 125 301 ⊗ 1882 301 239 ⊗ 1878 002 706 ◦ 3151 000 375	420 10 GF420 420GTZ KZIS-4	
			3482 124 534	430 GMF430	
			1878 003 657	420 10 420WGTZ	
			3151 000 375	KZIS-4	
	OM422A		1882 342 134	420 GF420X	
N 316 N 318	OM442LA		3400 700 379 ⊗ 3482 083 032 ⊗ 1878 004 832 ◦ 3151 000 157	430 10 MFZ430 430WGTZ KZISZ-5	

		CODE				
---	--	------	--	---	---	---















NEOPLAN

N 316 - N 318						
N 316 N 318	OM442LA	 3488 017 410	400 MFZ2/400X	enthält eine Kupplungsscheibe / This part number includes one clutch disc		(66)
		 1878 634 022 ▽#	400 10 400GVZ			
		 1878 005 805 ▽	400 10 400GTZ			
		 3151 000 157	KZISZ-5			
		 1878 005 805 △	400 10 400GTZ			
		 1878 634 023 △#	400 10 400GVZ			
N 316 L/U	D2866LUH20	 3482 083 032	430 MFZ430	Getr. / GBox: AS-Tronic ZF-Getriebe / ZF Transmission		(59)
		 1878 004 832	430 10 430WGTZ	Getr. / GBox: AS-Tronic ZF-Getriebe / ZF Transmission		(59)
		 3151 000 144	KZISZ-5	Getr. / GBox: AS-Tronic ZF-Getriebe / ZF Transmission		(59)
N 318	HS6R1315-524-24	 1861 206 211 #	420 10 420GS			
	D2866LUH20, 21, MAND2866LOH 26	 3482 062 035	430 GMFZ430			
		 1878 080 034	430 10 430WGTZ			
		 3151 000 157	KZISZ-5			
	D2876LOH01, MAND2866LOH 23	 3400 700 379	430 10 MFZ430			
		 3482 083 032	430WGTZ			
		 1878 004 832	430WGTZ			
	OM441LA	 3482 083 118	430 MFZ430			
		 1878 004 832	430 10 430WGTZ			
		 3151 000 157	KZISZ-5			
	OM447HLA	 3482 083 118	430 MFZ430			
		 1878 085 742	430 10 430WGTZ			
 3151 000 157		KZISZ-5				
N 320 - N 326						
N 326	OM403	 1800 125 301	420 10 GF420			
		 1882 301 239	420GTZ			
		 1878 002 706	KZIS-4			
		 3482 124 534	430 GMF430			
		 1878 003 657	420 10 420WGTZ			
N 326	OM422A	 3482 342 134	420 GF420X			
		 1882 342 134	420 GF420X			
N 326	OM403	 3482 124 516	430 GMF430			
		 1878 002 706	420 10 420GTZ			
		 1878 003 657 ●	420 10 420WGTZ			
N 326	HS6R1315-524-24	 1861 206 211 #	420 10 420GS			

		CODE		 Parameter		
---	--	------	--	---	---	---

NEOPLAN









N 412 - N 416

N 412		HS6R1112-562-18		1881 039 531 #	350 G350		
				1878 001 074	350 10 350GTZ		
		OM352		1882 252 331	310 GFX310		
				1861 303 248	310 10 310GSB		
N 413		HS6R1112-562-18		1881 039 531 #	350 G350		
				1878 001 074	350 10 350GTZ		
N 414		HS6R1112-562-18		1881 039 531 #	350 G350		
				1878 001 074	350 10 350GTZ		
N 416		DAFDKA1160V		1861 206 211 #	420 10 420GS		
		DAFDKCL1160V		1861 206 211 #	420 10 420GS		
				3482 124 550	430 GMF430		
				3482 006 036 ●#	420 GTF420		
		HS6R1315-524-24		3151 000 375	420 KZIS-4		
				1861 206 211 #	420 10 420GS		

N 418 - N 426

N 418		HS6R1315-524-24		1861 206 211 #	420 10 420GS		
N 426							

N 516 - N 526

N 516		OM442LA		3400 700 379 ● 3482 083 032 ● 1878 004 832 ● 3151 000 157	430 10 MFZ430 430WGTZ KZISZ-5		
N 516		OM442LA		3488 017 410	400 MFZ2/400X	enthält eine Kupplungsscheibe / This part number includes one clutch disc	(66)
				1878 634 022 ▽#	400 10 400GVZ		
				1878 005 805 ▽	400 10 400GTZ		
				3151 000 157	400 10 KZISZ-5		
				1878 005 805 △	400 10 400GTZ		
				1878 634 023 △#	400 10 400GVZ		
N 516		D2876LOH01, MAND2866LOH23		3400 700 379 ● 3482 083 032 ● 1878 004 832 ● 3151 000 157	430 10 MFZ430 430WGTZ KZISZ-5		





N 906 - N 940

N 906 Turbo		OM617		3082 156 031	228 M228	Getr. / GBox: ZF4DS18	
				3151 069 131	330 KZIS-1	Getr. / GBox: ZF4DS18	
N 907	01.82 -	OM352		3482 012 211	330 GMF330		
				1861 571 236	330 10 330GSZ		
				3151 044 031	330 KZI-3		

		CODE				
---	--	------	--	---	---	---





















NEOPLAN

N 906 - N 940

N 912 N 922 N 940		OM401		1882 311 131 #	350 GF350	Je nach Kundenwunsch mit unterschiedlicher Kupplung / Equipped with different clutch according to customer requirement	(33)
				1878 001 070	350 10 350GTZ		
				3482 124 534	430 GMF430	Je nach Kundenwunsch mit unterschiedlicher Kupplung / Equipped with different clutch according to customer requirement	(33)
				1882 301 239 ●	420 GF420	Je nach Kundenwunsch mit unterschiedlicher Kupplung / Equipped with different clutch according to customer requirement	(33)
				1878 002 706	420 10 420GTZ		

Skyliner

















09.73 -

Skyliner		DAFDKT1160		3482 124 550	430 GMF430				
				3482 006 036 ●#	420 GTF420				
		MAND2538MTA		3482 124 534	430 GMF430				
				1882 301 239 ●	420 GF420				
				1878 001 138	420 10 420GTZ				
		MAND2866LOH , 301kw, MAND2876LOH , 338kw		3482 083 032	430 MFZ430	Getr. / GBox: ZF 8S-180 AS-Tronic			
				1878 085 641	430 10 430GTZ	Getr. / GBox: ZF 8S-180 AS-Tronic			
				3151 000 157	KZISZ-5	Getr. / GBox: ZF 8S-180 AS-Tronic			
				6594 000 124	430 430Z	Getr. / GBox: ZF 8S-180 AS-Tronic enthält Schwungradbefestigungsschrauben / includes bolt for flyweel mounting	(65)		
		D2676LOH01-04, D2676LOH10/26-28		3482 000 246	430 MFZ430	Getr. / GBox: ZF 12 AS			
				1878 004 104 HD	430 10 430WGTZ	Getr. / GBox: ZF 12 AS			
				3151 000 144	KZISZ-5	Getr. / GBox: ZF 12 AS für Ausrückgabel mit Nocken / for release fork with cams	(69)		
				3151 000 493	KZISZ-5	Getr. / GBox: ZF 12 AS für Ausrückgabel mit Rollen / for release fork with rollers	(70)		
		N 1122/3 L N 1122/3 C	03.06-	D2676LOH04/27/28, D2676LOH31/32		3400 700 459 HD	430 10 MFZ430	Getr. / GBox: AS Tronic für Ausrückgabel mit Rollen / for release fork with rollers	(70)
						3482 000 246	430 MFZ430	Getr. / GBox: AS Tronic für Ausrückgabel mit Nocken / for release fork with cams	(69)
	1878 004 104 HD				430 10 430WGTZ	Getr. / GBox: AS Tronic für Ausrückgabel mit Nocken / for release fork with cams	(69)		
	3151 000 144				KZISZ-5	Getr. / GBox: AS Tronic für Ausrückgabel mit Nocken / for release fork with cams	(69)		
	6594 000 121				430 430Z	Getr. / GBox: AS Tronic für Ausrückgabel mit Nocken / for release fork with cams enthält Schwungradbefestigungsschrauben / includes bolt for flyweel mounting	(65)		
	1863 869 038								
D2676				1863 869 038					

		CODE				
---	--	------	--	---	---	---





























NEOPLAN

Spaceliner		09.79 -				
Spaceliner HC		D2866LOH, 301kw, D2876LOH, 338kw		6594 000 124	430 430Z	Getr. / GBox: ZF AS-Tronic enthält Schwungradbefestigungsschrauben / includes bolt for flyweel mounting (65)
				3482 083 032	430 MFZ430	Getr. / GBox: ZF AS-Tronic
				1878 085 641	430 10 430GTZ	Getr. / GBox: ZF AS-Tronic
				3151 000 157	KZISZ-5	Getr. / GBox: ZF AS-Tronic

Starliner		09.96 -					
Starliner L N 5217 SHD	02.04 - 02.05 -	D2876LOH		3400 700 459 HD ⊗ 3482 000 246 ⊗ 1878 004 104 ⊗ 3151 000 493	430 10 MFZ430 430WGTZ KZISZ-5	Getr. / GBox: AS-Tronic für Ausrückgabel mit Rollen / for release fork with rollers (70)	
				3151 000 144	KZISZ-5	Getr. / GBox: AS-Tronic für Ausrückgabel mit Nocken / for release fork with cams (69)	
	D2676LOH01/1 0		6594 000 121	430 430Z	für OE-Nummer / for OE number 51.02301.6086 enthält Schwungradbefestigungsschrauben / includes bolt for flyweel mounting (83) (65)		
			3482 000 361	430 MFZ430	Getr. / GBox: AS-Tronic		
			1878 080 037	430 10 430WGTZ	Getr. / GBox: AS-Tronic		
			3151 000 493	KZISZ-5	Getr. / GBox: AS-Tronic für Ausrückgabel mit Rollen / for release fork with rollers (70)		
	D2066LOH07/0 8/10, D2066LOH28/3 2, D2066LUH09/2 4/34/53, D2676LOH10/2 6/30		3151 000 144	KZISZ-5	Getr. / GBox: AS-Tronic für Ausrückgabel mit Nocken / for release fork with cams (69)		
			1863 869 038				
	N 516 N 516/3	09.96 - 09.96 -	D2876LOH/Euro 3		6594 000 124	430 430Z	Getr. / GBox: ZF 8S-180 Getr. / GBox: ZF 12 AS 2300 enthält Schwungradbefestigungsschrauben / includes bolt for flyweel mounting (65)
					3482 083 032	430 MFZ430	Getr. / GBox: ZF 8S-180 Getr. / GBox: ZF 12 AS 2300
				1878 085 641	430 10 430GTZ	Getr. / GBox: ZF 8S-180 Getr. / GBox: ZF 12 AS 2300	
				3151 000 157	KZISZ-5	Getr. / GBox: ZF 8S-180 Getr. / GBox: ZF 12 AS 2300	
N 516 N 516/3	09.02 - 09.02 -	D2866LOH/Euro 3		6594 000 124	430 430Z	Getr. / GBox: ZF 8S-180 Getr. / GBox: ZF 12 AS 2300 enthält Schwungradbefestigungsschrauben / includes bolt for flyweel mounting (65)	
				3482 083 032	430 MFZ430	Getr. / GBox: ZF 8S-180 Getr. / GBox: ZF 12 AS 2300	
				1878 085 641	430 10 430GTZ	Getr. / GBox: ZF 8S-180 Getr. / GBox: ZF 12 AS 2300	
				3151 000 157	KZISZ-5	Getr. / GBox: ZF 8S-180 Getr. / GBox: ZF 12 AS 2300	















		CODE				
---	--	------	--	---	---	---

NEOPLAN

























Starliner		09.96 -				
N 2216 SHD N 2216 SHD N 2216 SHD N 2216 SHD N 2216 SHD	01.02-	D2866LOH/LUH	 3482 000 361	430 MFZ430	Getr. / GBox: AS-Tronic	
	01.02-		 1878 080 034	430 10 430WGTZ	Getr. / GBox: AS-Tronic	
	01.02-		 3151 000 493	KZISZ-5	Getr. / GBox: AS-Tronic für Ausrückgabel mit Rollen / for release fork with rollers	(70)
	01.02-		 3151 000 144	KZISZ-5	Getr. / GBox: AS-Tronic für Ausrückgabel mit Nocken / for release fork with cams	(69)
	01.02-	D2876LOH	 3482 000 361	430 MFZ430	Getr. / GBox: AS-Tronic	
			 1878 004 104 HD	430 10 430WGTZ	Getr. / GBox: AS-Tronic	
			 3151 000 493	KZISZ-5	Getr. / GBox: AS-Tronic für Ausrückgabel mit Rollen / for release fork with rollers	(70)
			 3151 000 144	KZISZ-5	Getr. / GBox: AS-Tronic für Ausrückgabel mit Nocken / for release fork with cams	(69)
	01.02-	D2876LOH02/03	 1878 080 037	430 10 430WGTZ	Getr. / GBox: ZF 8S	
			 3151 000 034	KZISZ-5	Getr. / GBox: ZF 8S	
		D2866LOH29/33/34	 3400 700 507	430 10	XTend Getr. / GBox: ZF 6/8 S Nabenprofil / Hub Profile: 41,1x50,8-10N Nur zusammen verbauen / Only install together	(46) (51)
	D2066LOH07/08/10, D2066LOH28/32, D2066LUH09/24/34/53, D2676LOH10/26/30	D2066LOH07/08/10, D2066LOH28/32, D2676LOH10/26/30	 3400 700 381	430 10 MFZ430 430WGTZ KZISZ-5	Getr. / GBox: AS-Tronic für Ausrückgabel mit Rollen / for release fork with rollers	(70)
			 3482 000 361	430 MFZ430	Getr. / GBox: AS-Tronic für Ausrückgabel mit Nocken / for release fork with cams	(69)
			 1878 080 037	430 10 430WGTZ	Getr. / GBox: AS-Tronic für Ausrückgabel mit Nocken / for release fork with cams	(69)
			 3151 000 493	KZISZ-5	Getr. / GBox: AS-Tronic für Ausrückgabel mit Nocken / for release fork with cams für Ausrückgabel mit Rollen / for release fork with rollers	(69) (70)
	D2066LOH07/08/10, D2066LOH28/32, D2676LOH10/26/30	D2066LOH07/08/10, D2066LOH28/32, D2676LOH10/26/30	 3482 083 032	430 MFZ430	Getr. / GBox: GO210-6	
 1878 080 037			430 10 430WGTZ	Getr. / GBox: GO210-6		
 3151 000 335			KZISZ-5	Getr. / GBox: GO210-6		
	D2066LOH07/08/10/28, D2066LUH09/24/34, D2876LOH03/10/26	 3400 700 511	430 10	XTend Getr. / GBox: GO210-6 Nabenprofil / Hub Profile: 41,1x50,8-10N Nur zusammen verbauen / Only install together	(46) (51)	
	D2876LOH01, D2866LOH28, D2866LOH29, D2866LOH27	 1863 869 038				
N 5218 SHD N 5218 SHD	05.05- 05.05-	D2876LOH21, D2876LOH20	 3400 700 404	430 10 MFZ430 430WGTZ KZISZ-5	Getr. / GBox: AS-Tronic	
			 3482 000 246	430 10 MFZ430 430WGTZ KZISZ-5	Getr. / GBox: AS-Tronic für Ausrückgabel mit Rollen / for release fork with rollers	(70)
			 3482 000 246	430 10 MFZ430 430WGTZ KZISZ-5	Getr. / GBox: AS-Tronic für Ausrückgabel mit Rollen / for release fork with rollers	(70)
		 1878 002 139				
		 3151 000 144				
		 3400 700 445	430 10 MFZ430 430WGTZ KZISZ-5	Getr. / GBox: AS-Tronic für Ausrückgabel mit Rollen / for release fork with rollers	(70)	
		 3482 000 246	430 10 MFZ430 430WGTZ KZISZ-5	Getr. / GBox: AS-Tronic für Ausrückgabel mit Rollen / for release fork with rollers	(70)	
		 1878 002 139				
		 3151 000 493				

		CODE				
---	--	------	--	---	---	---

NEOPLAN

Tourliner		09.02 -				
N 2216/3SHD Tourliner C	09.05 -	D2066LOH07/0 8/10/28, D2066LUH09/2 4/34, D2676LOH10	 3400 700 505 ■	430 10	XTend Getr. / GBox: ZF 6 S Nabenprofil / Hub Profile: 41,1x50,8-10N Nur zusammen verbauen / Only install together	(46) (51)
		D2066LOH07/0 8/10/28, D2066LUH09/2 4/34, D2676LOH10/2 6	 3400 700 511 ◀■	430 10	XTend Getr. / GBox: GO 210-6 Nabenprofil / Hub Profile: 41,1x50,8-10N Nur zusammen verbauen / Only install together	(46) (51)
		D2066LOH07/0 8/10, D2066LOH28/3 2, D2066LUH09/2 4/34/53, D2676LOH10/2 6/30	 3400 700 381  3482 000 361  1878 080 037  3151 000 493	430 10 MFZ430 430WGTZ KZISZ-5	Getr. / GBox: AS Tronic für Ausrückgabel mit Rollen / for release fork with rollers	(70)
			 3482 000 361	430 MFZ430	Getr. / GBox: AS Tronic für Ausrückgabel mit Nocken / for release fork with cams	(69)
			 1878 080 037	430 10 430WGTZ	Getr. / GBox: AS Tronic für Ausrückgabel mit Nocken / for release fork with cams	(69)
			 3151 000 144	KZISZ-5	Getr. / GBox: AS Tronic für Ausrückgabel mit Nocken / for release fork with cams	(69)
		D2066LOH07/0 8/10, D2066LOH28/3 2, D2676LOH10/2 6/30	 3482 083 032	430 MFZ430	Getr. / GBox: GO 210-6	
			 1878 080 037	430 10 430WGTZ	Getr. / GBox: GO 210-6	
			 3151 000 335	KZIZ-5	Getr. / GBox: GO 210-6	
		D2066LOH07/0 8/28, D2676LOH26	 6594 000 121	430 430Z	Getr. / GBox: GO 210-6 enthält Schwungradbefestigungsschrauben / includes bolt for flyweel mounting	(65)
			 1863 869 038			



















NEOPLAN

Tourliner		09.02 -						
N 2216 SHD N 2216 SHD N 2216 SHD N 2216 SHD N 2216 SHDL N 2216 SHDL N 2216 SHDL	01.03-	D2866LOH/LUH		3482 000 361	430 MFZ430	Getr. / GBox: AS-Tronic		
	06.06-			1878 080 034	430 10 430WGTZ	Getr. / GBox: AS-Tronic		
	06.06-			3151 000 493	KZISZ-5	Getr. / GBox: AS-Tronic für Ausrückgabel mit Rollen / for release fork with rollers	(70)	
	01.03-			3151 000 144	KZISZ-5	Getr. / GBox: AS-Tronic für Ausrückgabel mit Nocken / for release fork with cams	(69)	
	06.06-	D2876LOH		3482 000 361	430 MFZ430	Getr. / GBox: AS-Tronic		
	01.03-			1878 004 104 HD	430 10 430WGTZ	Getr. / GBox: AS-Tronic		
	01.03-			3151 000 493	KZISZ-5	Getr. / GBox: AS-Tronic für Ausrückgabel mit Rollen / for release fork with rollers	(70)	
	01.03-			3151 000 144	KZISZ-5	Getr. / GBox: AS-Tronic für Ausrückgabel mit Nocken / for release fork with cams	(69)	
			D2876LOH02/03		1878 080 037	430 10 430WGTZ	Getr. / GBox: ZF 8S	
					3151 000 034	KZISZ-5	Getr. / GBox: ZF 8S	
			D2866LOH29/33/34		3400 700 507 	430 10 XTend	Getr. / GBox: ZF 6/8 S Nabenprofil / Hub Profile: 41,1x50,8-10N Nur zusammen verbauen / Only install together	(46) (51)
			D2066LOH07/08/10, D2066LOH28/32, D2066LUH09/24/34/53, D2676LOH10/26/30		3400 700 381  3482 000 361  1878 080 037  3151 000 493	430 10 MFZ430 430WGTZ KZISZ-5	Getr. / GBox: AS-Tronic für Ausrückgabel mit Rollen / for release fork with rollers	(70)
					3482 000 361	430 MFZ430	Getr. / GBox: AS-Tronic für Ausrückgabel mit Nocken / for release fork with cams	(69)
					1878 080 037	430 10 430WGTZ	Getr. / GBox: AS-Tronic für Ausrückgabel mit Nocken / for release fork with cams	(69)
					3151 000 493	KZISZ-5	Getr. / GBox: AS-Tronic für Ausrückgabel mit Nocken / for release fork with cams für Ausrückgabel mit Rollen / for release fork with rollers	(69) (70)
			D2066LOH07/08/10, D2066LOH28/32, D2676LOH10/26/30		3482 083 032	430 MFZ430	Getr. / GBox: GO210-6	
					1878 080 037	430 10 430WGTZ	Getr. / GBox: GO210-6	
					3151 000 335	KZISZ-5	Getr. / GBox: GO210-6	
			D2066LOH07/08/10/28, D2066LUH09/24/34, D2876LOH03/10/26		3400 700 511 	430 10 XTend	Getr. / GBox: GO210-6 Nabenprofil / Hub Profile: 41,1x50,8-10N Nur zusammen verbauen / Only install together	(46) (51)
			D2876LOH03, D2066LOH04, D2866LOH34, D2066LOH03		1863 869 038			

		CODE				
---	--	------	--	---	---	---

























NEOPLAN

Trendliner 09.04 -

13 M	D2066LOH07/0 8/10, D2066LOH28/3 2, D2066LUH09/2 4/34/53, D2866LOH10/2 6/30	 3400 700 381  3482 000 361  1878 080 037  3151 000 493	430 10 MFZ430 430WGTZ KZISZ-5	Getr. / GBox: AS-Tronic für Ausrückgabel mit Rollen / for release fork with rollers	(70)
	D2066LOH06/1 2/27/32, D2066LUH07/0 8/22/23, D2066LUH32/3 3/47/48, D2066LUH51/5 2	 3482 000 361	430 MFZ430	Getr. / GBox: AS-Tronic für Ausrückgabel mit Nocken / for release fork with cams	(69)
		 1878 080 034	430 10 430WGTZ	Getr. / GBox: AS-Tronic für Ausrückgabel mit Rollen / for release fork with rollers	(70)
		 3151 000 493	KZISZ-5	Getr. / GBox: AS-Tronic für Ausrückgabel mit Rollen / for release fork with rollers	(70)
		 3482 000 361	430 MFZ430	Getr. / GBox: AS-Tronic für Ausrückgabel mit Nocken / for release fork with cams	(69)
	D2066LUH08/2 3/28/33, D2066LUH48LO H06/27, D2866LUH29/3 7265KW	 3400 700 507 	430 10	XTend Getr. / GBox: ZF 6S Nabenprofil / Hub Profile: 41,1x50,8-10N Nur zusammen verbauen / Only install together	(46) (51)
		D2066LOH07/0 8/10/28, D2066LUH09/2 4/34, D2676LOH10	 3400 700 505 	430 10	XTend Getr. / GBox: ZF 6S Nabenprofil / Hub Profile: 41,1x50,8-10N Nur zusammen verbauen / Only install together
	D2066LUH047, D2066LUH07/2 2/27/32, D2866LUH2822 8KW	 3400 700 506 	430 10	XTend Getr. / GBox: ZF 6S Nabenprofil / Hub Profile: 41,1x50,8-10N Nur zusammen verbauen / Only install together	(46) (51)
	D2066LOH07/0 8/10/26, D2066LOH28, D2066LUH09/2 4/34	 3400 700 511 	430 10	XTend Getr. / GBox: GO210-6 Nabenprofil / Hub Profile: 41,1x50,8-10N Nur zusammen verbauen / Only install together	(46) (51)
	D2866LUH29/3 7265KW, D2866LUH29/3 7301KW	 3400 700 509 	430 10	XTend Getr. / GBox: GO210-6 Nabenprofil / Hub Profile: 41,1x50,8-10N Nur zusammen verbauen / Only install together	(46) (51)
		 1863 869 038			























		CODE				
---	--	------	--	---	---	---

NEOPLAN



Trendliner		09.04 -				
N 3516 Ü	09.04 -	D2066LOH07/0 8/10, D2066LOH28/3 2, D2066LUH09/2 4/34/53	 3400 700 381  3482 000 361  1878 080 037  3151 000 493	430 10 MFZ430 430WGTZ KZISZ-5	Getr. / GBox: AS-Tronic für Ausrückgabel mit Rollen / for release fork with rollers	(70)
			 3482 000 361	430 MFZ430	Getr. / GBox: AS-Tronic für Ausrückgabel mit Nocken / for release fork with cams	(69)
			 1878 080 037	430 10 430WGTZ	Getr. / GBox: AS-Tronic für Ausrückgabel mit Nocken / for release fork with cams	(69)
			 3151 000 144	KZISZ-5	Getr. / GBox: AS-Tronic für Ausrückgabel mit Nocken / for release fork with cams	(69)
		D2066LOH06/1 2/27/31, D2066LUH08/2 2/23/32, D2066LUH33/4 7/48/51, D2066LUH52, D2866LOH/LUH	 3482 000 361	430 MFZ430	Getr. / GBox: AS-Tronic für Ausrückgabel mit Rollen / for release fork with rollers	(70)
			 1878 080 034	430 10 430WGTZ	Getr. / GBox: AS-Tronic für Ausrückgabel mit Rollen / for release fork with rollers	(70)
			 3151 000 493	KZISZ-5	Getr. / GBox: AS-Tronic für Ausrückgabel mit Rollen / for release fork with rollers	(70)
			 3482 000 361	430 MFZ430	Getr. / GBox: AS-Tronic für Ausrückgabel mit Nocken / for release fork with cams	(69)
			 1878 080 034	430 10 430WGTZ	Getr. / GBox: AS-Tronic für Ausrückgabel mit Nocken / for release fork with cams	(69)
			 3151 000 144	KZISZ-5	Getr. / GBox: AS-Tronic für Ausrückgabel mit Nocken / for release fork with cams	(69)
		D2066LOH06/2 7, D2066LUH33/4 8, D2066LUH08/2 3/28, D2066LUH08/2 3/28, D2066LUH33/4 8, D2866LUH29/3 7/265KW, D2866LUH29/3 7/301KW	 3400 700 507 	430 10	XTend Getr. / GBox: ZF 6S Nabenprofil / Hub Profile: 41,1x50,8-10N Nur zusammen verbauen / Only install together	(46) (51)
		D2066LOH07/2 2/27, D2066LOH32/4 7, D2866LUH28/2 8KW	 3400 700 506 	430 10	XTend Getr. / GBox: ZF 6S Nabenprofil / Hub Profile: 41,1x50,8-10N Nur zusammen verbauen / Only install together	(46) (51)
		D2066LOH07/0 8/10/28, D2066LUH09/2 4/34, D2676LOH	 3400 700 505 	430 10	XTend Getr. / GBox: ZF 6S Nabenprofil / Hub Profile: 41,1x50,8-10N Nur zusammen verbauen / Only install together	(46) (51)
		D2866LUH29/3 01KW, D2866LUH29/3 7/265KW	 3400 700 509 	430 10	XTend Getr. / GBox: GO210-6 Nabenprofil / Hub Profile: 41,1x50,8-10N Nur zusammen verbauen / Only install together	(46) (51)
	D2066LOH07/0 8/10/28, D2066LUH09/2 4/34, D2676LOH10/2 6	 3400 700 511 	430 10	XTend Getr. / GBox: GO210-6 Nabenprofil / Hub Profile: 41,1x50,8-10N Nur zusammen verbauen / Only install together	(46) (51)	
	D2866LUH29	 1863 869 038				

		CODE				
---	--	------	--	---	---	---

NEOPLAN

Trendliner		09.04 -					
N 3516/3 ÜL	09.04 -	D2066LOH07/0 8/10, D2066LOH28/3 2, D2066LUH09/2 4/34/53	 3400 700 381  3482 000 361  1878 080 037  3151 000 493	430 10 MFZ430 430WGTZ KZISZ-5	Getr. / GBox: AS-Tronic für Ausrückgabel mit Rollen / for release fork with rollers	(70)	
			 3482 000 361	430 MFZ430	Getr. / GBox: AS-Tronic für Ausrückgabel mit Nocken / for release fork with cams	(69)	
			 1878 080 037	430 10 430WGTZ	Getr. / GBox: AS-Tronic für Ausrückgabel mit Nocken / for release fork with cams	(69)	
			 3151 000 144	KZISZ-5	Getr. / GBox: AS-Tronic für Ausrückgabel mit Nocken / for release fork with cams	(69)	
		D2066LOH06/1 2/27/31, D2066LUH07/0 8/22/23, D2066LUH23/3 2/33/47, D2066LUH47/4 8/51/52, D2866LOH/LUH	 3482 000 361	430 MFZ430	Getr. / GBox: AS-Tronic für Ausrückgabel mit Rollen / for release fork with rollers	(70)	
			 1878 080 034	430 10 430WGTZ	Getr. / GBox: AS-Tronic für Ausrückgabel mit Rollen / for release fork with rollers	(70)	
			 3151 000 493	KZISZ-5	Getr. / GBox: AS-Tronic für Ausrückgabel mit Rollen / for release fork with rollers	(70)	
			 3482 000 361	430 MFZ430	Getr. / GBox: AS-Tronic für Ausrückgabel mit Nocken / for release fork with cams	(69)	
			 1878 080 034	430 10 430WGTZ	Getr. / GBox: AS-Tronic für Ausrückgabel mit Nocken / for release fork with cams	(69)	
			 3151 000 144	KZISZ-5	Getr. / GBox: AS-Tronic für Ausrückgabel mit Nocken / for release fork with cams	(69)	
			D2066LUH08/2 3/28/33, D2066LUH48LO H06/27, D2866LUH29/3 7265KW, D2866LUH29/3 7301KW	 3400 700 507 	430 10	XTend Getr. / GBox: ZF 6S Nabenprofil / Hub Profile: 41,1x50,8-10N Nur zusammen verbauen / Only install together	(46) (51)
			D2066LOH07/0 8/10/28, D2066LUH09/2 4/34, D2676LOH10	 3400 700 505 	430 10	XTend Getr. / GBox: ZF 6S Nabenprofil / Hub Profile: 41,1x50,8-10N Nur zusammen verbauen / Only install together	(46) (51)
			D2066LUH07/2 2/27/32, D2066LUH47	 3400 700 506 	430 10	XTend Getr. / GBox: ZF 6S Nabenprofil / Hub Profile: 41,1x50,8-10N Nur zusammen verbauen / Only install together	(46) (51)
			D2066LOH07/0 8/10/28, D2066LOH07/0 8/10/28, D2066LUH09/2 4/34	 3400 700 511  	430 10	XTend Getr. / GBox: GO210-6 Nabenprofil / Hub Profile: 41,1x50,8-10N Nur zusammen verbauen / Only install together	(46) (51)
				 1863 869 038			

ÖSTERREICHISCHE AUTOMOBILFABRIK (ÖAF)



Omnibus						
Omnibus / deck bus GSR + GS			 3482 124 534	430 GMF430		
			1882 301 239	420 GF420		
			 1878 001 155 ▲#	420 10 420WGTZ		
			 1863 009 100	GR-5	mit Anlauftring / with thrust ring	(88)

		CODE				
---	--	------	--	---	---	---























ORION WERKE

W...Serie						
WH 153				1863 100 030	GR-3	mit Anlauffring / with thrust ring (88)







PAZ

BUS						
Bus		MMZ		3482 125 512	362 MF362	Getr. / GBox: ZF-S5-42
				1878 001 501	362 10 362GTZ	Getr. / GBox: ZF-S5-42
				3151 000 079	KZI-3	Getr. / GBox: ZF-S5-42

RENAULT TRUCKS

ARES - 03.99						
Ares				3482 083 252	430 MFZ430	Getr. / GBox: B8 TBV
				1878 020 241	430 20 430WGTZ	Getr. / GBox: B8 TBV
				3151 250 231	KZISZ-5	Getr. / GBox: B8 TBV
				3482 083 252	430 MFZ430	Getr. / GBox: ZF 6S-85 Getr. / GBox: ZF 8S-180
				3400 700 493  3482 083 252  1878 004 832	430 10 MFZ430 430WGTZ	->10.2001 Getr. / GBox: ZF 8S-180 bis Produktionsnummer / to production Number: CAM 15K1 (63)
				1878 026 241	430 10 430WGTZ	Getr. / GBox: ZF 6S-85
				3151 250 231	KZISZ-5	Getr. / GBox: ZF 6S-85 Getr. / GBox: ZF 8S-180
				3482 083 252	430 MFZ430	Getr. / GBox: ZF 10AS2301
				3400 700 493  3482 083 252  1878 004 832	430 10 MFZ430 430WGTZ	->10.2001 Getr. / GBox: ZF 10AS2301 bis Produktionsnummer / to production Number: CAM 15K1 (63)
				3151 000 144	KZISZ-5	Getr. / GBox: ZF 10AS2301
				3400 700 493  3482 083 252  1878 004 832	430 10 MFZ430 430WGTZ	->10.2001 Getr. / GBox: ZF 6S-1600 bis Produktionsnummer / to production Number: CAM 15K1 (63)
				3482 083 252	430 MFZ430	Getr. / GBox: ZF 6S-1600
				3151 250 231	KZISZ-5	Getr. / GBox: ZF 6S-1600
				3482 078 134	400 MFZ400	Getr. / GBox: 6S-1600
				1878 032 032	400 10 400WGTZ	Getr. / GBox: 6S-1600
	3151 000 157	KZISZ-5	Getr. / GBox: 6S-1600			

































AXER - 03.99						
C956				3400 700 328  3482 078 134  1878 032 032  3151 000 157	400 10 MFZ400 400WGTZ KZISZ-5	

E 7						
E 7 C	01.75-	798		3400 700 339  3482 124 041  1878 001 729  3151 270 341	350 10 MF350 350GTD KZIS-3	Getr. / GBox: ZFS5-35
E 7 L, M, N		MAN2156		1882 302 131 HD	380 GF380	
		MAN2356		3482 037 141	380 GM380	

		CODE					
---	--	------	--	--	---	---	---

RENAULT TRUCKS











E 53							
Serie E 53	06.71 - 12.79	MAN2356		3482 037 141	380	GM380	

FR 1							
FR 1	04.90 -			3400 116 701  3482 097 141  1878 026 241  3100 008 106	430 10 GMFZ430 430WGTZ KZISZ-5	->09.1992 Getr. / GBox: ZF S6-150	
				3400 116 601  3482 097 141  1878 020 241  3100 008 106	430 20 GMFZ430 430WGTZ KZISZ-5	->09.1992 Getr. / GBox: B9	
		MIDR062045		3400 700 329  3482 083 044  1878 022 841  3100 008 106	430 10 MFZ430 430GTZ KZISZ-5	10.1992-> Getr. / GBox: ZF S8-180	
				3400 116 901  3482 083 044  1878 026 241  3100 008 106	430 10 MFZ430 430WGTZ KZISZ-5	10.1992-> Getr. / GBox: ZF S6-90, S6-85	
		MIDR062045M3		3400 117 202  3482 083 044  1878 020 241  3100 008 106	430 20 MFZ430 430WGTZ KZISZ-5	10.1992-> Getr. / GBox: B8L	
FR 1 E-T-GT	11.92 -	MIDR062045		3400 116 901  3482 083 044  1878 026 241  3100 008 106	430 10 MFZ430 430WGTZ KZISZ-5	Getr. / GBox: ZF S6-90, ZF S6-85	
				3400 700 329  3482 083 044  1878 022 841  3100 008 106	430 10 MFZ430 430GTZ KZISZ-5	Getr. / GBox: ZF S8-180	
				3400 117 202  3482 083 044  1878 020 241  3100 008 106	430 20 MFZ430 430WGTZ KZISZ-5	Getr. / GBox: B9/B8L	



		CODE					
---	--	------	--	--	---	---	---

RENAULT TRUCKS

ILIADÉ - 03.99

Iliade	10.96-			3400 117 202 ⊗ 3482 083 044 ⊗ 1878 020 241 ⊙ 3100 008 106	430 20 MFZ430 430WGTZ KZISZ-5	->05.1997 Getr. / GBox: B 8 170R1 TBV	
				3400 123 401 ⊗ 3482 083 252 ⊗ 1878 020 241 ⊙ 3151 250 231	430 20 MFZ430 430WGTZ KZISZ-5	06.1997-> Getr. / GBox: B9,B8 170R5 TBV	
				3400 116 901 ⊗ 3482 083 044 ⊗ 1878 026 241 ⊙ 3100 008 106	430 10 MFZ430 430WGTZ KZISZ-5	->08.1997 Getr. / GBox: ZF S6-85	
				3400 700 409 ⊗ 3482 083 252 ⊗ 1878 026 241 ⊙ 3151 250 231	430 10 MFZ430 430WGTZ KZISZ-5	09.1997-> Getr. / GBox: ZF S6-85	
				3482 083 044	430 MFZ430	->10.1997 Getr. / GBox: ZF S8-180 bis Produktionsnummer / to production Number: CAM 11KV	(63)
				1878 004 832	430 10 430WGTZ	->10.1997 Getr. / GBox: ZF S8-180 bis Produktionsnummer / to production Number: CAM 11KV	(63)
				3100 008 106 ⊙ 3151 234 132 ⊙ 3180 000 009	KZISZ-5 KZISZ-5	->10.1997 Getr. / GBox: ZF S8-180 bis Produktionsnummer / to production Number: CAM 11KV Beinhaltet Ausrücker und Montagesatz / Contains releaser and fitting kit	(63) (14)
				3400 700 330 ⊗ 3482 083 252 ⊗ 1878 004 832 ⊙ 3151 250 231	430 10 MFZ430 430WGTZ KZISZ-5	10.1997-> Getr. / GBox: ZF S8-180 ab Produktionsnummer / from Production Number: CAM 12KV	(60)
				3482 083 252	430 MFZ430	Getr. / GBox: ZF 6S-1600	
	3151 250 231	KZISZ-5	Getr. / GBox: ZF 6S-1600				



KAROSA - 03.99

MIHR 062045				3482 083 044	430 MFZ430		
				1878 026 241	430 10 430WGTZ		
				3100 008 106 ⊙ 3151 234 132 ⊙ 3180 000 009	KZISZ-5 KZISZ-5	Beinhaltet Ausrücker und Montagesatz / Contains releaser and fitting kit	(14)

OBRADORE - 03.99

Obradore	10.96-	MIDR062045M1 MIDR062045M4 1, MIDR062056A4 1 MIDR062045M4 1, MIDR062056A4 1, MIDR062345A4 1		3400 123 401 ⊗ 3482 083 252 ⊗ 1878 020 241 ⊙ 3151 250 231	430 20 MFZ430 430WGTZ KZISZ-5	Getr. / GBox: B9/B8L	
				3482 083 252	430 MFZ430	Getr. / GBox: ZF S8-180	
				1878 022 841	430 10 430GTZ	Getr. / GBox: ZF S8-180	
				3151 250 231	KZISZ-5	Getr. / GBox: ZF S8-180	

PR

8	01.86-			3482 124 041	350 MF350		
				1878 002 075 #	350 16 350GTZ		
				3151 000 285	KZI-4		





RÈCREO - 03.99

C935	10.96-	MIHR062045A/4 1		3400 116 901 ⊗ 3482 083 044 ⊗ 1878 026 241 ⊙ 3100 008 106	430 10 MFZ430 430WGTZ KZISZ-5	Getr. / GBox: 5P 115	
------	--------	--------------------	---	---	---	----------------------	--

		CODE					
---	--	------	--	--	---	---	---

RENAULT TRUCKS









RÉCREO - 03.99

C955			 3400 700 328  3482 078 134  1878 032 032  3151 000 157	400 10 MFZ400 400WGTZ KZISZ-5		
------	--	--	--	--	--	--

S

















45			 3482 002 233 #	360 GMF360	Chass. 365->	
			 1864 509 041	350 10 350Z	Chass. 365->	
53		MAN	 3482 002 233 #	360 GMF360	Chass. 1512->	
			 1864 509 041	350 10 350Z	Chass. 1512->	
105	10.92 -	MAN0846	 3482 002 233 #	360 GMF360	Getr. / GBox: RVI332	
			 1864 509 041	350 10 350Z	Getr. / GBox: RVI332	

TRACER - 03.99

332		MIHR062045	 3482 097 141	430 GMFZ430	->12.1992 Getr. / GBox: G406	
			 1878 049 041 #	430 16 430WGTZ	->12.1992 Getr. / GBox: G406	
			 3100 008 106  3151 234 132  3180 000 009	KZISZ-5 KZISZ-5	->12.1992 Getr. / GBox: G406 Beinhaltet Ausrücker und Montagesatz / Contains releaser and fitting kit	(14)
			 3400 700 341 #  3482 083 044  1878 049 041  3100 008 106	430 16 MFZ430 430WGTZ KZISZ-5	01.1993-> Getr. / GBox: G406	

































SCANIA

Bus

B 116			 3482 119 034	430 GMF430	Nur zusammen verbauen / Only install together	(51)
			 3482 001 234 ●#	420 GMF420		
			 1878 003 339	420 10 420GTZ	Nur zusammen verbauen / Only install together	(51)
BR 85 BR 86			 3482 124 514	420 GMF430	Mot. DS8	
			 1878 001 138	420 10 420GTZ	Mot. DS8	
BR 116			 3400 125 901 ☉  3482 119 034  1878 003 238	430 22 GMF430 420GTZ	Getr. / GBox: G764 Getr. / GBox: G774	
			 3482 001 234 ●#	420 GMF420	Getr. / GBox: G764 Getr. / GBox: G774	
			 1878 003 339	420 10 420GTZ	Getr. / GBox: G764 Nur zusammen verbauen / Only install together	(51)
BR 140 BR 145			 1878 001 138	420 10 420GTZ	Mot. DS8	
CR 85			 3482 124 514	420 GMF430	Mot. DS8 Nur zusammen verbauen / Only install together	(51)
			 1878 001 138	420 10 420GTZ	Mot. DS8 Nur zusammen verbauen / Only install together	(51)
K 82			 3482 119 034	430 GMF430		
			 3482 001 234 ●#	420 GMF420		
			 1878 003 339	420 10 420GTZ		

























		CODE					
---	--	------	--	--	---	---	---

SCANIA





Bus								
K94 / L94 / N94 / 114 / 124	01.95-	K402-5	 3482 112 031	400 MFZ400X				
			 1878 043 231	400 24 400WGVZ				
			 3182 009 938	HHISZ-4	Immer erneuern / Renew everytime	(28)		
			 3180 007 000		Immer erneuern / Renew everytime Montagesatz für Ausrücklager / Fitting kit for releaser	(28) (44)		
		K432-8	 3400 123 701 ⊕ ⊕ 3483 020 036 ⊕ 1878 003 066	430 24 MFZ430 430WGTZ				
			 3482 083 039	430 MFZ430	In 3483/3488 enthalten / Contained in 3483, 3488	(30)		
			 3100 008 201 ◦ 3151 000 272 ⊙ 3180 000 009	KZIS-5 KZISZ-5				
		K432-15	 3482 083 039	430 MFZ430				
			 1878 063 231 #	430 24 430WGTZ				
			 3182 009 938	HHISZ-4	Immer erneuern / Renew everytime	(28)		
			 3180 007 000		Immer erneuern / Renew everytime Montagesatz für Ausrücklager / Fitting kit for releaser	(28) (44)		
		K432-16	 3400 122 001 ⊖ ⊖ 3482 083 150 ⊖ 1878 063 231	430 24 MFZ430 430WGTZ				
			 3182 009 938	HHISZ-4	Immer erneuern / Renew everytime	(28)		
			 3180 007 000		Immer erneuern / Renew everytime Montagesatz für Ausrücklager / Fitting kit for releaser	(28) (44)		
		K432-17	 3482 083 039	430 MFZ430				
			 1878 063 231 #	430 24 430WGTZ				
			 3182 009 938	HHISZ-4	Immer erneuern / Renew everytime	(28)		
			 3180 007 000		Immer erneuern / Renew everytime Montagesatz für Ausrücklager / Fitting kit for releaser	(28) (44)		
		K432-18	 3482 083 150	430 MFZ430				
			 3182 009 938	HHISZ-4	Immer erneuern / Renew everytime	(28)		
			 3180 007 000		Immer erneuern / Renew everytime Montagesatz für Ausrücklager / Fitting kit for releaser	(28) (44)		
		K432-30, K432-31, K432-32	 3400 700 354 ⊖ 3482 000 251 ⊖ 1878 003 066 ◦ 3151 000 151	430 24 MFZ430 430WGTZ KZISZ-5				
			 3400 125 701 ⊖ 3482 119 031 ⊖ 1878 003 269 ◦ 3151 000 395	430 10 GMF430 420GTZ KZIS-4	Mot. DSC11			
			 3482 018 132 ●#	420 GMF420	Mot. DSC11			
K 112	 3482 118 031	430 GMF430	Mot. DS11					
	 1878 003 269	420 10 420GTZ	Mot. DS11					
	 3151 000 515	KZIS-4	Mot. DS11					
	 3482 124 514	420 GMF430						
	 1878 003 238	420 22 420GTZ						
	 3400 125 901 ⊖ ⊖ 3482 119 034 ⊖ 1878 003 238	430 22 GMF430 420GTZ						
	 3482 001 234 ●#	420 GMF420						
	 1878 003 339	420 10 420GTZ						

		CODE				
---	--	------	--	---	---	---

SCANIA



















Bus Serie 3		01.89 - 12.97				
K 93 CL K 113 K 113 CLB K 113 CLB L 113 CLB L 113 CLB	01.91 - 12.96	K402-1	 3400 123 501 ⊕ ⊕ 3483 028 031 ⊕ 1862 450 031	400 22 MFZ400X 400GVZ		
	11.90 -		 3482 112 031	400 MFZ400X	In 3483/3488 enthalten / Contained in 3483, 3488	(30)
	07.90 - 12.96		 3100 008 201 ⊕ 3151 000 272 ⊙ 3180 000 009	KZIZ-5 KZISZ-5	Beinhaltet Ausrücker und Montagesatz / Contains releaser and fitting kit In 3483/3488 enthalten / Contained in 3483, 3488	(14)
	01.91 - 12.97	K402-3	 3400 123 601 ⊕ ⊕ 3483 028 031 ⊕ 1878 043 231	400 24 MFZ400X 400WGVZ		
	11.93 - 12.96		 3482 112 031	400 MFZ400X	In 3483/3488 enthalten / Contained in 3483, 3488	(30)
	01.90 - 12.96		 3100 008 201 ⊕ 3151 000 272 ⊙ 3180 000 009	KZIZ-5 KZISZ-5	Beinhaltet Ausrücker und Montagesatz / Contains releaser and fitting kit In 3483/3488 enthalten / Contained in 3483, 3488	(14)
	K422-9		 3400 125 901 ⊖ ⊕ 3482 119 034 ⊕ 1878 003 238	430 22 GMF430 420GTZ		
			 3482 001 234 ●#	420 GMF420		
			K422-12	 3482 119 034	430 GMF430	
	 3482 001 234 ●#	420 GMF420				
	 1878 003 658	420 24 420WGTZ				
	K432-3		 3482 119 034	430 GMF430		
			 3482 001 234 ●#	420 GMF420		
			 1862 328 031	420 22 420WGVZ		
	K432-9		 3482 119 034	430 GMF430		
			 3482 001 234 ●#	420 GMF420		
	K432-10		 3482 083 039	430 MFZ430		
			 1878 063 231 #	430 24 430WGTZ		
			 3100 008 201 ⊕ 3151 000 272 ⊙ 3180 000 009	KZIZ-5 KZISZ-5		
	K432-11, K432-12		 3482 119 034	430 GMF430		
			 3482 001 234 ●#	420 GMF420		
	K432-14		 3482 083 039	430 MFZ430		
			 1878 063 231 #	430 24 430WGTZ		
			 3100 008 201 ⊕ 3151 000 272 ⊙ 3180 000 009	KZIZ-5 KZISZ-5		

SETRA

Serie 400		06.01 -				
ComfortClass S 415 GT 632.121 ComfortClass S 415 GT, S 416 GT 632.125 632.121	10.03 -	OM457.952, OM457.941, OM457.965	 3482 000 852	430 MFZ430	je nach Ausführung, mit unterschiedlicher Kupplung / depending on version, with different clutch	(85)
	10.03 -		 1878 005 541	430 10 430WGTZ	je nach Ausführung, mit unterschiedlicher Kupplung / depending on version, with different clutch	(85)
			 3151 000 335	KZIZ-5	je nach Ausführung, mit unterschiedlicher Kupplung / depending on version, with different clutch	(85)
			 3400 700 509 ■	430 10 XTend Nabenprofil / Hub Profile: 41,1x50,8-10N	je nach Ausführung, mit unterschiedlicher Kupplung /	(85)

























		CODE				
---	--	------	--	---	---	---

SETRA

Serie 400		06.01 -				
ComfortClass S 415 GT, GT-HD 632.121 632.131 ComfortClass S 415 GT, GT-HD 632.121 632.131	10.03-	OM457.952, OM457.941, OM457.961, OM457.965, OM457.944, OM457.953	 3482 000 852	430 MFZ430	je nach Ausführung, mit unterschiedlicher Kupplung / depending on version, with different clutch	(85)
	10.03-		 1878 005 541	430 10 430WGTZ	je nach Ausführung, mit unterschiedlicher Kupplung / depending on version, with different clutch	(85)
			 3151 000 335	KZIZ-5	je nach Ausführung, mit unterschiedlicher Kupplung / depending on version, with different clutch	(85)
			 3400 700 509 	430 10	XTend Nabenprofil / Hub Profile: 41,1x50,8-10N Nur zusammen verbauen / Only install together je nach Ausführung, mit unterschiedlicher Kupplung / depending on version, with different clutch	(46) (51) (85)
			 6594 000 079	430 430Z	Fahrzeuge können mit unterschiedlichen Komponenten bestückt sein. / Vehicles may be fitted with different components enthält Schwungradbefestigungsschrauben / includes bolt for flywheel mounting	(21) (65)
ComfortClass S 416 GT-HD, ComfortClass S 417 GT-HD 632.133/134 ComfortClass S 416 GT-HD, ComfortClass S 417 GT-HD 632.133/134	10.03-	OM457.961, OM457.944, OM457.953	 3482 000 851	430 MFZ430	für / for: 2200 [Nm] Getr. / GBox: Powershift je nach Ausführung, mit unterschiedlicher Kupplung / depending on version, with different clutch	(68) (85)
	10.03-		 1878 005 540	430 10 430WGTZ	für / for: 2200 [Nm] Getr. / GBox: Powershift je nach Ausführung, mit unterschiedlicher Kupplung / depending on version, with different clutch	(68) (85)
			 3151 000 335	KZIZ-5	für / for: 2200 [Nm] Getr. / GBox: Powershift je nach Ausführung, mit unterschiedlicher Kupplung / depending on version, with different clutch	(68) (85)
			 3482 000 852	430 MFZ430	für / for: 2300 [Nm] Getr. / GBox: Powershift je nach Ausführung, mit unterschiedlicher Kupplung / depending on version, with different clutch	(68) (85)
			 1878 005 541	430 10 430WGTZ	für / for: 2300 [Nm] Getr. / GBox: Powershift je nach Ausführung, mit unterschiedlicher Kupplung / depending on version, with different clutch	(68) (85)
			 3151 000 335	KZIZ-5	für / for: 2300 [Nm] Getr. / GBox: Powershift je nach Ausführung, mit unterschiedlicher Kupplung / depending on version, with different clutch	(68) (85)
			 3400 700 509 	430 10	XTend Nabenprofil / Hub Profile: 41,1x50,8-10N je nach Ausführung, mit unterschiedlicher Kupplung / depending on version, with different clutch Nur zusammen verbauen / Only install together	(46) (85) (51)
			 6594 000 079	430 430Z	Fahrzeuge können mit unterschiedlichen Komponenten bestückt sein. / Vehicles may be fitted with different components enthält Schwungradbefestigungsschrauben / includes bolt for flywheel mounting	(21) (65)
MultiClass S 412 UL 633.100 MultiClass S 415 UL 633.101 MultiClass S 417 UL 633.103 MultiClass S 419 UL 633.104		OM457.952	 3400 700 509 	430 10	XTend Getr. / GBox: G0/190/210 Nabenprofil / Hub Profile: 41,1x50,8-10N Nur zusammen verbauen / Only install together	(46) (51)
			 6594 000 079	430 430Z	für / for: SA522019-08 Getr. / GBox: G0/190/210 enthält Schwungradbefestigungsschrauben / includes bolt for flywheel mounting	(68) (65)



























		CODE				
---	--	------	--	---	---	---

SETRA

Serie 400		06.01 -					
S 415 HDH 629.623 S 416 HDH 629.625 S 417 HDH 629.627	01.07 -	OM457LA		3482 000 851	430 MFZ430	für / for: 2200 [Nm] Getr. / GBox: Powershift je nach Ausführung, mit unterschiedlicher Kupplung / depending on version, with different clutch	(68) (85)
	01.07 -			1878 005 540	430 10 430WGTZ	für / for: 2200 [Nm] Getr. / GBox: Powershift je nach Ausführung, mit unterschiedlicher Kupplung / depending on version, with different clutch	(68) (85)
	01.07 -			3151 000 335	KZIZ-5	für / for: 2200 [Nm] Getr. / GBox: Powershift je nach Ausführung, mit unterschiedlicher Kupplung / depending on version, with different clutch	(68) (85)
				3482 000 852	430 MFZ430	für / for: 2300 [Nm] Getr. / GBox: Powershift je nach Ausführung, mit unterschiedlicher Kupplung / depending on version, with different clutch	(68) (85)
				1878 005 541	430 10 430WGTZ	für / for: 2300 [Nm] Getr. / GBox: Powershift je nach Ausführung, mit unterschiedlicher Kupplung / depending on version, with different clutch	(68) (85)
				3151 000 335	KZIZ-5	für / for: 2300 [Nm] Getr. / GBox: Powershift je nach Ausführung, mit unterschiedlicher Kupplung / depending on version, with different clutch	(68) (85)
				3400 700 509 	430 10	XTend Nabenprofil / Hub Profile: 41,1x50,8-10N je nach Ausführung, mit unterschiedlicher Kupplung / depending on version, with different clutch Nur zusammen verbauen / Only install together	(46) (85) (51)
				3400 700 509 	430 10	XTend Nabenprofil / Hub Profile: 41,1x50,8-10N Nur zusammen verbauen / Only install together	(46) (51)
TopClass S 411 HD 629.610 629.410 TopClass S 415 HD 629.411 629.612 TopClass S 416 HDH, TopClass S 417 HDH 629.422 629.425 629.625	10.01 -	OM541.950, OM457.961, OM542.948, OM457.944, OM457.953		3400 700 509 	430 10	XTend Nabenprofil / Hub Profile: 41,1x50,8-10N Nur zusammen verbauen / Only install together	(46) (51)
	10.01 -			3400 700 512 	430 10	XTend Getr. / GBox: AS Tronic Nabenprofil / Hub Profile: 41,1x50,8-10N Nur zusammen verbauen / Only install together	(46) (51)
TopClass S 415 HDH 629.421 629.623	10.01 -	OM457.944		3400 700 509 	430 10	XTend Getr. / GBox: GO 210 Nabenprofil / Hub Profile: 41,1x50,8-10N Nur zusammen verbauen / Only install together	(46) (51)
				3400 700 512 	430 10	XTend Getr. / GBox: AS Tronic Nabenprofil / Hub Profile: 41,1x50,8-10N Nur zusammen verbauen / Only install together	(46) (51)
				3151 000 144	KZISZ-5	Getr. / GBox: AS Tronic für Ausrückgabel mit Nocken / for release fork with cams	(69)
				3151 000 493	KZISZ-5	Getr. / GBox: AS Tronic für Ausrückgabel mit Rollen / for release fork with rollers	(70)
				1863 869 028			
		OM457.944, OM457.961		6594 000 079	430 430Z	für / for: SA522019-08/15 enthält Schwungradbefestigungsschrauben / includes bolt for flywheel mounting	(68) (65)
				3421 601 050	430	für / for: SA522019-04 mit Zahnkranz / with ring gear mit Anlauftring / with thrust ring	(68) (93) (88)
		OM542.966		3421 601 016	430	mit Zahnkranz / with ring gear mit Anlauftring / with thrust ring	(93) (88)







		CODE				
---	--	------	--	---	---	---

SETRA



















Serie 400		06.01 -			
TopClass S 415 HDH 629.421 629.623	10.01 -	OM457.961	 3400 700 509  430 10 XTend Getr. / GBox: GO 210 Nabenprofil / Hub Profile: 41,1x50,8-10N Nur zusammen verbauen / Only install together (46) (51)		
			 3400 700 512  430 10 XTend Getr. / GBox: AS Tronic Nabenprofil / Hub Profile: 41,1x50,8-10N Nur zusammen verbauen / Only install together (46) (51)		
			 3151 000 144 KZISZ-5 Getr. / GBox: AS Tronic für Ausrückgabel mit Nocken / for release fork with cams (69)		
			 3151 000 493 KZISZ-5 Getr. / GBox: AS Tronic für Ausrückgabel mit Rollen / for release fork with rollers (70)		
			 1863 869 028		
		OM457.944, OM457.961	 6594 000 079 430 430Z für / for: SA522019-08/15 enthält Schwungradbefestigungsschrauben / includes bolt for flywheel mounting (68) (65)		
			 3421 601 050 430 für / for: SA522019-04 mit Zahnkranz / with ring gear mit Anlauftring / with thrust ring (68) (93) (88)		
			 3421 601 016 430 mit Zahnkranz / with ring gear mit Anlauftring / with thrust ring (93) (88)		
		OM542.966	 3421 601 016 430 mit Zahnkranz / with ring gear mit Anlauftring / with thrust ring (93) (88)		
		TopClass S 415 HDH 629.623 629.421	10.01 -	OM542.966	 3400 700 509  430 10 XTend Getr. / GBox: GO 210 Nabenprofil / Hub Profile: 41,1x50,8-10N Nur zusammen verbauen / Only install together (46) (51)
 3400 700 512  430 10 XTend Getr. / GBox: AS Tronic Nabenprofil / Hub Profile: 41,1x50,8-10N Nur zusammen verbauen / Only install together (46) (51)					
 3151 000 144 KZISZ-5 Getr. / GBox: AS Tronic für Ausrückgabel mit Nocken / for release fork with cams (69)					
 3151 000 493 KZISZ-5 Getr. / GBox: AS Tronic für Ausrückgabel mit Rollen / for release fork with rollers (70)					
 1863 869 028					
OM457.944, OM457.961	 3421 601 016 430 mit Zahnkranz / with ring gear mit Anlauftring / with thrust ring (93) (88)				
	 6594 000 079 430 430Z für / for: SA522019-08/15 enthält Schwungradbefestigungsschrauben / includes bolt for flywheel mounting (68) (65)				
	 3421 601 050 430 für / for: SA522019-04 mit Zahnkranz / with ring gear mit Anlauftring / with thrust ring (68) (93) (88)				
TopClass S 431 DT 410.001 317.011	10.02 -			OM502	 3400 700 509  430 10 XTend Nabenprofil / Hub Profile: 41,1x50,8-10N Leistung [kW] / Engine Output [kW]: 320 Leistung [kW] / Engine Output [kW]: 350 Nur zusammen verbauen / Only install together (46) (38) (38) (51)
					 3400 700 525  430 10 XTend Nabenprofil / Hub Profile: 41,1x50,8-10N Leistung [kW] / Engine Output [kW]: 370 Nur zusammen verbauen / Only install together (46) (38) (51)
		 3151 000 335 KZISZ-5 Leistung [kW] / Engine Output [kW]: 320 Leistung [kW] / Engine Output [kW]: 350 Leistung [kW] / Engine Output [kW]: 370 (38) (38) (38)			
		OM542.948	 1863 869 028		

		CODE					
---	--	------	--	--	---	---	---

SETRA



Serie 400		06.01 -				
TopClass S 431 DT 410.001	10.02-	OM502	 3400 700 509 ■	430 10	XTend Nabenprofil / Hub Profile: 41,1x50,8-10N Leistung [kW] / Engine Output [kW]: 320 Leistung [kW] / Engine Output [kW]: 350 Nur zusammen verbauen / Only install together	(46) (38) (38) (51)
			 3400 700 525 ◐■	430 10	XTend Nabenprofil / Hub Profile: 41,1x50,8-10N Leistung [kW] / Engine Output [kW]: 370 Nur zusammen verbauen / Only install together	(46) (38) (51)
	OM542.948	 3482 000 852	430 MFZ430	für / for: 2300 [Nm] Getr. / GBox: Powershift	(68)	
		 1878 005 541	430 10 430WGTZ	für / for: 2300 [Nm] Getr. / GBox: Powershift	(68)	
		 3151 000 335	KZIZ-5	für / for: 2300 [Nm] Getr. / GBox: Powershift	(68)	
		 1863 869 028		für / for: SA 505120-01	(68)	

TAM



Bus						
75 A5,6			 1880 083 132 #	280 G280		
120 B3			 3482 083 032	430 MFZ430		
			 1878 004 832	430 10 430WGTZ		
			 3151 000 034	KZISZ-5		
125 A 11T,P 3000 A 3000 3500 AS 3500,D125			 1881 039 532 #	350 G350KR		
			 1878 001 074	350 10 350GTZ		
190 107M 190 A11 190 A110 190 A94,102,131	-04.90 05.90- -04.90		 1882 325 134	380 G380		
			 1878 001 152	380 10 380WGTZ		
260			 1800 125 301	420 10 GF420		
			 3482 124 534 ●	430 GMF430		
260 A113 260 A116 260 A117 260 A119 260 A120 260 A180 321 A119			 1878 003 657	420 10 420WGTZ		
331 A119			 1882 342 134	420 GF420X	ZF-Getriebe / ZF Transmission	(59)
			 1878 003 657	420 10 420WGTZ	ZF-Getriebe / ZF Transmission	(59)
			 3151 126 031	KZI-4,5	ZF-Getriebe / ZF Transmission	(59)
3500 AS 3500 D150			 1878 001 074	350 10 350GTZ		
TVM Marbus B3 090 TH TVM Marbus B3 090 TL TVM Marbus B3 090 TLL		D0836LOHEuroII	 3482 000 463	395 MF395		
			 1862 506 131	395 10 395WGTZ		
			 3151 000 419	KZIS-4		



		CODE				
---	--	------	--	---	---	---

TAM





Bus						
TVM Marbus B4 080 TS		D0834LOH02, EuroIII	 3482 000 463	395 MF395		
			 1862 506 131	395 10 395WGTZ		
			 3151 000 419	KZIS-4		

TEMSA

OPALIN						
Opalin 9		D0836LOH56	 3482 000 463	395 MF395	für / for: Euro 3 für / for: Euro 4	(68) (68)
			 1878 001 709	395 10 395WGTZ	für / for: Euro 4	(68)
			 1862 506 131	395 10 395WGTZ	für / for: Euro 3	(68)

SAFARI						
Safari 13		DAFXE315C1	 3482 083 032	430 MFZ430	Getr. / GBox: ZF 8S-180	
			 1878 080 037	430 10 430WGTZ	Getr. / GBox: ZF 8S-180	
			 3151 000 157	KZISZ-5	Getr. / GBox: ZF 8S-180	





































VAN HOOL

A 120						
A 120		MAN	 3482 124 541	430 GMF430		
			 1882 330 032 ●#	420 GF420		
			 1878 001 136	420 10 420GTZ		
			 3151 000 515	KZIS-4		
		DAF	 1878 001 138	420 10 420GTZ		

8..						
812 813 814 815 A 815 C 815 TL		MAN240/280PS	 3482 124 534	430 GMF430		
			 1882 301 239 ●	420 GF420		
			 1878 002 706	420 10 420GTZ		
			 3151 000 515	KZIS-4		

		CODE					
---	--	------	--	--	---	---	---

































VAN HOOL

8..							
815		DAFDKX1160	 1882 342 134	420 GF420X			
			 1878 002 706	420 10 420GTZ			
			 3151 000 395	KZIS-4			
		DBOM422A	 1882 342 134	420 GF420X			
			 1878 002 706	420 10 420GTZ			
			 3151 000 395	KZIS-4			
		DBOM422LA	 3482 124 549	430 GMF430			
			 1882 342 135 ●#	420 GF420X			
			 1878 086 741	420 10 430WGTZ			
			 3151 000 395	KZIS-4			
		MAND2866FH	 3482 018 132 #	420 GMF420			
			3482 119 031	430 GMF430			
			 1878 086 741	420 10 430WGTZ			
			 3151 249 001	KZI-5			
		MAND2866KOH	 3482 124 549	430 GMF430			
			 1882 342 135 ●#	420 GF420X			
			 1878 086 741	420 10 430WGTZ			
			 3151 000 395	KZIS-4			
		MAND2866OH	 1882 342 134	420 GF420X			
			 3151 000 395	KZIS-4			
		MAND2866TOH , LOH	 1882 342 134	420 GF420X			
			 1878 002 706	420 10 420GTZ			
			 3151 000 395	KZIS-4			
		815, A 815 C		Fiat	 3482 085 033	420 MF420	enthält Druckplattenbefestigungsschrauben / includes bolt for pressure plate mounting
 1878 001 138	420 10 420GTZ						
815 A		DAF	 3400 700 305  3482 118 031  1878 002 706  3151 000 515	430 10 GMF430 420GTZ KZIS-4			
815, A TD 824		Fiat	 3482 085 033	420 MF420	enthält Druckplattenbefestigungsschrauben / includes bolt for pressure plate mounting	(64)	
			 1878 002 955	420 10 420GTZ			
			 3151 000 515	KZIS-4			
815 GT		5LF, D2866LOH, MAND2566M TH, D286	 1882 342 134	420 GF420X			
			 1878 002 706	420 10 420GTZ			
			 3151 000 395	KZIS-4			
		DMOM422, A	 1882 342 134	420 GF420X			
			 1878 002 706	420 10 420GTZ			
			 3151 000 395	KZIS-4			



		CODE					
---	--	------	--	--	---	---	---

VAN HOOL

8..







815 TLC		MAND2866LUH08		3482 119 031	430 GMF430	Getr. / GBox: ZF6S-85	
				1878 061 841	430 10 430WGTZ	Getr. / GBox: ZF6S-85	
				3151 249 001	KZI-5	Getr. / GBox: ZF6S-85	
				3151 000 034	KZISZ-5	Getr. / GBox: ZF6S-85	
816 (Altano Royal)		MAND2866		3482 124 549	430 GMF430		
				1882 342 135 ●#	420 GF420X		
				1878 086 741	420 10 430WGTZ		
				3151 000 395	KZIS-4		
818		MAND2566MKUH		1882 342 134	420 GF420X		
				1878 002 706	420 10 420GTZ		
				3151 000 395	KZIS-4		
				3482 124 549	430 GMF430		
		MAND2866KUH		1882 342 135 ●#	420 GF420X		
				1878 086 741	420 10 430WGTZ		
				3151 000 395	KZIS-4		
				1882 302 131	380 GF380		
T 811		MAN		1878 001 152	380 10 380WGTZ		
				3151 000 395	KZIS-4		
				3482 119 031	430 GMF430	Getr. / GBox: 6-85 ZF-Getriebe / ZF Transmission	(59)
T 815 UL		2866LOH07		1878 086 741	420 10 430WGTZ	Getr. / GBox: 6-85 ZF-Getriebe / ZF Transmission	(59)
				3151 249 001	KZI-5	Getr. / GBox: 6-85 ZF-Getriebe / ZF Transmission	(59)
				3482 124 549	430 GMF430		
TD 824		OM422LA, D2866KOH,		1882 342 135 ●#	420 GF420X		
				1878 086 741	420 10 430WGTZ		
				3151 000 395	KZIS-4		
				1882 342 134	420 GF420X		
TD 824 E		DBOM422LA		1878 002 706	420 10 420GTZ		
				3151 000 395	KZIS-4		
				3488 017 333	400 MFZ2/400X	enthält eine Kupplungsscheibe / This part number includes one clutch disc	(66)
TD 827		D2866LOH		1862 303 031 ▽	400 10 400WGVZ	Lose Kupplungsscheibe / Loose clutch disc	(39)
				3151 000 034	KZISZ-5		
				1862 302 031 △	400 8 400GVZ	In 3483/3488 enthalten / Contained in 3483, 3488	(30)

9..









915		MAN2866LOH23		3482 119 031	430 GMF430	Getr. / GBox: ZF 8S180	
				1878 086 742 #	420 10 420GTZ	Getr. / GBox: ZF 8S180	
				3151 249 001	KZI-5	Getr. / GBox: ZF 8S180	









		CODE				
---	--	------	--	---	---	---

VAN HOOL

9..						
T 911 Alicron T 915 Acron T 915 Alicron T 916 Altano T 917 Acron T 917 Altano T 917 Astron T 918 Altano		D2866LOH29		3488 000 108 #⊕	400 MFZ2/400X	Getr. / GBox: ZF 8S-180 enthält eine Kupplungsscheibe / This part number includes one clutch disc (66)
				1878 002 643	400 10 400WGTZ	Getr. / GBox: ZF 8S-180
TD 924 Astromega TD 927 Astromega		D2876LOH02		3482 000 209	430 MFZ430	Getr. / GBox: ZF 8S-180
				1878 085 641	430 10 430GTZ	Getr. / GBox: ZF 8S-180
				3151 000 278	KZISZ-5	Getr. / GBox: ZF 8S-180
				3488 000 108 ●#⊕	400 MFZ2/400X	Getr. / GBox: ZF 8S-180 für Fahrzeuge mit Zweischeibenkupplung / for vehicles with double disc clutch enthält eine Kupplungsscheibe / This part number includes one clutch disc (77) (66)
				1878 002 643 ●	400 10 400WGTZ	Getr. / GBox: ZF 8S-180 für Fahrzeuge mit Zweischeibenkupplung / for vehicles with double disc clutch (77)





VOLKSWAGEN





















CRAFTER 30-35 Bus (2E_) 04.06 -						
2.5 TDI, 65 kW	04.06 - 07.11	BJJ, CEBA		3000 990 204 3000 951 841 3182 997 804	240 HHAS-1	XTend Kit plus CSC
				1863 869 012	28	Nadellager / Needle Bearing (47)
				6284 605 004		
2.5 TDI, 80 kW 2.5 TDI, 100 kW	04.06 - 04.06 -	BJK, CEBA, BJL, CECA		3000 990 204 ⊕ 3000 951 841 3182 997 804	240 HHAS-1	XTend Kit plus CSC
				3000 990 217 3000 951 876 3182 997 802	240 HHAS-1	XTend Kit plus CSC Getr. / GBox: Shiftmatic (SMC)
				1863 869 012	28	Nadellager / Needle Bearing (47)
2.5 TDI, 120 kW	04.06 - 07.11	BJM, CECB		3000 990 246 ⊕ 3000 951 932 3182 997 804	260 26 HHAS-1	XTend Kit plus CSC
				3000 990 217 3000 951 876 3182 997 802	240 HHAS-1	XTend Kit plus CSC Getr. / GBox: Shiftmatic (SMC)
				1863 869 012	28	Nadellager / Needle Bearing (47)

LT 28-35 I Bus (281-363) 04.75 - 06.96						
2.4	12.82 - 07.92	DL		3000 055 006 3082 190 031 1861 897 034 3151 193 041	228 23 M228 228TB KZIS-0	
				1863 869 002	24	Nadellager / Needle Bearing (47)
				3074 003 343 LHD		08.1989->
2.4 i	08.89 - 06.96	1E		3000 055 006 3082 190 031 1861 897 034 3151 193 041	228 23 M228 228TB KZIS-0	
				1863 869 002	24	Nadellager / Needle Bearing (47)
				3074 003 343 LHD		->12.1995
2.4 D, 51 kW 2.4 TD, 70 kW	08.89 - 06.96 09.92 - 06.96	1S, ACL, ACT		3000 055 005 3082 190 031 1878 004 776 3151 193 041	228 23 M228 220VTPB KZIS-0	
				1863 869 002	24	Nadellager / Needle Bearing (47)
				3074 003 343 LHD		->12.1995

		CODE					
---	--	------	--	--	---	---	---











VOLKSWAGEN

LT 28-35 I Bus (281-363) 04.75 - 06.96							
2.4 D, 55 kW	01.79-07.92	DW, CP		3000 055 005 ⊗ 3082 190 031 ⊗ 1878 004 776 ⊙ 3151 193 041	228 23 M228 220VTPB KZIS-0		
				1863 869 002	24	Nadellager / Needle Bearing	(47)
		DW		3074 003 343		08.1989->	
2.4 TD, 68 kW 2.4 TD, 75 kW	08.89-08.92 12.82-07.89	DV, 1G		3000 055 005 ⊗ 3082 190 031 ⊗ 1878 004 776 ⊙ 3151 193 041	228 23 M228 220VTPB KZIS-0		
				1863 869 002	24	Nadellager / Needle Bearing	(47)





LT 28-35 II Bus (2DB, 2DE, 2DK) 04.96 - 07.06							
2.3	05.96-07.06	AGL		3000 826 901 ⊗ 3082 268 031 ⊗ 1878 994 001 ⊙ 3151 248 031	240 26 M240 240TB KZIS-0		
				6283 600 115			
				6284 600 573			
2.5 SDI	07.96-07.06	AGX		3000 845 801 ⊗ 3082 639 402 ⊗ 1878 988 102 ⊙ 3151 248 031	240 26 MF240 240TB KZIS-0		
				1863 869 005	24	Nadellager / Needle Bearing	(47)
				6283 600 115			
				6284 600 573			
2.5 TDI, 61 kW 2.5 TDI, 70 kW	05.01-07.06 05.01-07.06	BBF, BBE		3000 951 104 ⊗ 3082 600 522 ⊗ 1878 988 102 ⊙ 3151 248 031	240 26 M240 240TB KZIS-0		
				1863 869 005	24	Nadellager / Needle Bearing	(47)
				6283 600 115			
				6284 600 573			
2.5 TDI, 66 kW	05.99-07.06	APA		3000 845 101 ⊗ 3082 308 043 ⊗ 1878 988 102 ⊙ 3151 248 031	240 26 MF240 240TB KZIS-0		
				1863 869 005	24	Nadellager / Needle Bearing	(47)
				6283 600 115			
				6284 600 573			
2.5 TDI, 75 kW	05.96-08.99	AHD		3000 845 101 ⊗ 3082 308 043 ⊗ 1878 988 102 ⊙ 3151 248 031	240 26 MF240 240TB KZIS-0	für / for: LT 46	(68)
				3000 828 601 ⊗ 3082 308 043 ⊗ 1864 528 442 ⊙ 3151 248 031	240 26 MF240 240B KZIS-0	->Mot. 047 378 für / for: LT 28/35	(68)
				3000 845 101 ⊗ 3082 308 043 ⊗ 1878 988 102 ⊙ 3151 248 031	240 26 MF240 240TB KZIS-0	Mot. 047 379-> für / for: LT 28/35	(68)
				1863 869 005	24	Nadellager / Needle Bearing	(47)
				6283 600 115			
				6284 600 573			

		CODE					
---	--	------	--	--	---	---	---

VOLKSWAGEN

LT 28-35 II Bus (2DB, 2DE, 2DK) 04.96 - 07.06								
2.5 TDI, 80 kW	05.99 - 07.06	ANJ		3000 951 710 ⊗ 3082 600 509 ⊗ 1878 988 102 ⊙ 3151 248 031	240 26 MF240 240TB KZIS-0	->Mot. 052609		
				3000 951 104 ⊗ 3082 600 522 ⊗ 1878 988 102 ⊙ 3151 248 031	240 26 M240 240TB KZIS-0		Mot. 052610->	
			AVR		3000 951 104 ⊗ 3082 600 522 ⊗ 1878 988 102 ⊙ 3151 248 031		240 26 M240 240TB KZIS-0	
		AVR, ANJ		1863 869 005	24	Nadellager / Needle Bearing	(47)	
				6283 600 115				
				6284 600 573				
2.8 TDI, 92 kW	02.97 - 12.98	AGK		3000 845 001 ⊗ 3082 919 001 ⊗ 1864 528 442 ⊙ 3151 248 031	240 26 MF240 240B KZIS-0			
				1863 869 005	24	Nadellager / Needle Bearing	(47)	
2.8 TDI, 96 kW	01.99 - 01.02	ATA		3000 845 001 ⊗ 3082 919 001 ⊗ 1864 528 442 ⊙ 3151 248 031	240 26 MF240 240B KZIS-0			
				1863 869 005	24	Nadellager / Needle Bearing	(47)	
2.8 TDI, 116 kW	05.01 - 06.06	AUH, BCQ		3000 951 107 ■	240 26	XTend ->Chass. 2D-2-036 000 Nabenprofil / Hub Profile: 26,5x28,9-26N nur in Verbindung mit / only in connection with: 062 105 266 F	(46) (101)	
				3000 951 107 ■	240 26		XTend Chass. 2D-2-036 001-> Nabenprofil / Hub Profile: 26,5x28,9-26N	(46)























VOLVO

B 6 11.91 -								
B 6 / B 6 BLE				3482 909 001 #	350 MF350	Chass. 5000-> Mot. TD 63 E		
				1878 076 031	350 10 350GTB		Chass. 5000-> Mot. TD 63 E	
				3151 600 534	KZA-4		Chass. 5000-> Mot. TD 63 E	
B 6 , F, FA	12.78 -			3400 116 201 # ⊗ 3482 909 001 ⊗ 1878 076 031 ⊙ 3151 600 535	350 10 MF350 350GTB KZA-4	Mot. TD 60		
B 7 01.92 -								
B 7				3400 037 031 ⊗ 3482 021 031 ⊗ 1878 000 961 ⊙ 3151 600 533	380 10 GM380 380GTZ KZA-4	Chass. 20000-> Mot. TD 71 G		

		CODE					
---	--	------	--	--	---	---	---

VOLVO

B 7 01.92 -

















B7R / B7R LE		KFD116B	 3400 125 601 ⊕ ⊗ 3483 022 032 ⊙ 1878 003 779	400 10 MFZ400X 400WGTZ	->Chass. 2163 Getr. / GBox: S6-85		
			 3482 101 032	400 MFZ400X	->Chass. 2163 Getr. / GBox: S6-85 In 3483/3488 enthalten / Contained in 3483, 3488	(30)	
			 3482 101 032	400 MFZ400X	->Chass. 2163 Getr. / GBox: S6-90		
			 1878 003 779	400 10 400WGTZ	->Chass. 2163 Getr. / GBox: S6-90		
			 3400 125 601 ⊕ ⊗ 3483 022 032 ⊙ 1878 003 779	400 10 MFZ400X 400WGTZ	->Chass. 355806 Getr. / GBox: S6-820,S6-1550		
			 3482 101 032	400 MFZ400X	->Chass. 355806 Getr. / GBox: S6-820,S6-1550 In 3483/3488 enthalten / Contained in 3483, 3488	(30)	
		KFD117		 3483 034 045 ⊕	430 MFZ430	Chass. 2164-> Getr. / GBox: S6-85	
					 3482 123 235	430 MFZ430	Chass. 2164-> Getr. / GBox: S6-85 In 3483/3488 enthalten / Contained in 3483, 3488
				 1878 040 334	430 10 430WGTZ	Chass. 2164-> Getr. / GBox: S6-85	
				 3483 034 044 ⊕	430 MFZ430	Chass. 2164-> Getr. / GBox: S6-90	
				 3482 123 235	430 MFZ430	Chass. 2164-> Getr. / GBox: S6-90 In 3483/3488 enthalten / Contained in 3483, 3488	(30)
				 1878 040 334	430 10 430WGTZ	Chass. 2164-> Getr. / GBox: S6-90	
		KFD117C		 3482 123 235	430 MFZ430	Chass. 355807-> Getr. / GBox: S6-820,S6-1550	
				 1878 003 779	400 10 400WGTZ	Chass. 355807-> Getr. / GBox: S6-820,S6-1550	
				 3100 002 549 ⊙ 3151 000 218 ⊙ 3180 001 008	KZIZ-5 KZISZ-5	Chass. 355807-> Getr. / GBox: S6-820,S6-1550	
		KFD117E		 3400 127 201 ⊕ ⊗ 3483 034 033 ⊙ 1862 530 231	430 10 MFZ430 430WGTZ	->Chass. 6485 Getr. / GBox: EGS-V,EGS-VR	
				 3483 034 033 ⊕	430 MFZ430	Chass. 6486-> Getr. / GBox: EGS-V,EGS-VR	
				 1878 001 215	430 24 430WGTZ	Chass. 6486-> Getr. / GBox: EGS-V,EGS-VR	
				 3482 123 234	430 MFZ430	Getr. / GBox: EGS-V,EGS-VR In 3483/3488 enthalten / Contained in 3483, 3488	(30)
				 3483 034 045 ⊕	430 MFZ430	Getr. / GBox: 6S-1380BD	
				 3482 123 235	430 MFZ430	Getr. / GBox: 6S-1380BD In 3483/3488 enthalten / Contained in 3483, 3488	(30)
				 1878 040 334	430 10 430WGTZ	Getr. / GBox: 6S-1380BD	

B 9

B 9 M	01.79-		 3400 037 032 ⊗ 3482 021 031 ⊙ 1878 000 961 ⊙ 3151 824 005	380 10 GM380 380GTZ KZA-4	->Chass. 11499 Chass. 11540 - Chass. 11643 Mot. THD 100 D, E Getr. / GBox: S6-65	
			 1800 107 133 # ⊗ 1882 226 533 ⊙ 1861 672 033 ⊙ 3151 600 534	420 10 G420 420GSZ KZA-4	->Chass. 11499 Mot. THD 100 D, E Getr. / GBox: S6-80	

		CODE					
---	--	------	--	--	---	---	---















VOLVO

B 9		01.02 -					
B 9	09.05-		 3483 034 042 ⊕	430 MFZ430	Getr. / GBox: ZF6S-1600		
B 9	09.05-		 1878 634 026	430 10 430WGTZ	Getr. / GBox: ZF6S-1600		
B 9	09.05-		 3100 026 431 ⊕ 3151 000 154 ⊙ 3180 000 009	KZISZ-5	Getr. / GBox: ZF6S-1600 Beinhaltet Ausrücker und Montagesatz / Contains releaser and fitting kit In 3483/3488 enthalten / Contained in 3483, 3488	(14)	(30)
B 9	09.05-		 3400 700 342 ⊕ ⊕ 3483 034 033 ⊕ 1878 000 634	430 24 MFZ430 430WGTZ	Getr. / GBox: EGS-V / EGS-VR		
B 9	09.05-		 3400 710 060 ⊕ 3482 000 552 ⊕ 1878 003 867 ⊕ 6482 000 155	430 24 MF430 430WGTZ PHIS-6/38	Getr. / GBox: AT2412C		
B 9	09.05-		 1863 869 037	72			
B 10		01.78 - 12.01					
B 10 B B 10 BLE		KFD117C/D	 3483 034 032 ⊕	430 MFZ430	->Chass. 393 Getr. / GBox: G7-EGS Getr. / GBox: G8-EGS		
			 1878 634 026	430 10 430WGTZ	->Chass. 393 Getr. / GBox: G7-EGS Getr. / GBox: G8-EGS		
			 3482 123 235	430 MFZ430	->Chass. 393 Getr. / GBox: G7-EGS Getr. / GBox: G8-EGS In 3483/3488 enthalten / Contained in 3483, 3488	(30)	
		KFD117E	 3400 043 032 ⊕ ⊕ 3483 034 033 ⊕ 1878 634 026	430 10 MFZ430 430WGTZ	Chass. 394-> Getr. / GBox: G7-EGS Getr. / GBox: G8-EGS		
			 3482 123 234	430 MFZ430	Chass. 394-> Getr. / GBox: G7-EGS Getr. / GBox: G8-EGS In 3483/3488 enthalten / Contained in 3483, 3488	(30)	
			 3483 034 033 HD⊕	430 MFZ430	Getr. / GBox: VT2412B		
		KFD116B	 3400 125 601 ⊕ ⊕ 3483 022 032 ⊕ 1878 003 779	400 10 MFZ400X 400WGTZ	->Chass. 7014 Getr. / GBox: S6-85		
			 3482 101 032	400 MFZ400X	->Chass. 7014 Getr. / GBox: S6-85 In 3483/3488 enthalten / Contained in 3483, 3488	(30)	
		KFD117	 3483 034 045 ⊕	430 MFZ430	Chass. 7015-> Getr. / GBox: S6-85		
			 1878 040 334	430 10 430WGTZ	Chass. 7015-> Getr. / GBox: S6-85		
B 10 R	01.78 -		 1800 107 133 # ⊕ 1882 226 533 ⊕ 1861 672 033 ⊕ 3151 600 534	420 10 G420 420GSZ KZA-4	Mot. THD 100 D, E Getr. / GBox: S6-80 ,		

		CODE					
---	--	------	--	--	---	---	---

VOLVO

B 10 01.78 - 12.01





















B10M B10M B10M		KFD214A		1800 107 133 # ⊕ 1882 226 533 ⊕ 1861 672 033 ⊕ 3151 600 534	420 10 G420 420GSZ KZA-4	Mot. THD 101 G, K Mot. THD 100 D, E Getr. / GBox: S6-80 ,S6-90			
				1800 125 001 ⊕ 1882 250 143 ⊕ 1878 001 079 1878 001 083 ⊕ 3151 600 533 = 1874 000 098	350 10 GF2/350 350GTZ 350GTZ KZA-4	Chass. 11500 - Chass. 11540 Chass. 11643 - Chass. 27774 Mot. THD 101 G, K Getr. / GBox: S6-90 ohne Zwischenring / without intermediate ring	(105)		
				1888 019 445 #	350 GF2/350	Chass. 11500 - Chass. 11540 Chass. 11643 - Chass. 27774 Mot. THD 101 G, K Getr. / GBox: S6-90 enthält eine Kupplungsscheibe / This part number includes one clutch disc	(66)		
				1878 001 083 ▽	350 10 350GTZ	Chass. 11500 - Chass. 11540 Chass. 11643 - Chass. 27774 Mot. THD 101 G, K Getr. / GBox: S6-90 Lose Kupplungsscheibe / Loose clutch disc	(39)		
				3151 600 533	KZA-4	Chass. 11500 - Chass. 11540 Chass. 11643 - Chass. 27774 Mot. THD 101 G, K Getr. / GBox: S6-90			
				3400 106 031 ⊕ ⊕ 3483 034 032 ⊕ 1862 530 231	430 10 MFZ430 430WGTZ	-> Chass. 25456 Mot. THD 101 G Mot. THD 102 K Getr. / GBox: G7-EGS			
				3400 040 032 ●⊕ ⊕ 3483 034 032 ⊕ 1861 988 040	430 10 MFZ430 430GVZ	-> Chass. 25456 Mot. THD 101 G Mot. THD 102 K Getr. / GBox: G7-EGS			
				3483 034 032 ⊕	430 MFZ430	Chass. 25457-> Mot. KE Mot. THD 101 G Mot. THD 102 K Getr. / GBox: G7-EGS			
				1878 634 026	430 10 430WGTZ	Chass. 25457-> Mot. KE Mot. THD 101 G Mot. THD 102 K Getr. / GBox: G7-EGS			
				3400 031 033 ⊕ ⊕ 3483 014 132 ⊕ 1878 001 080 1878 001 082 = 3474 012 000	350 10 GMFZ2/350 350GTZ 350GTZ	Chass. 20001 - Chass. 25456 Mot. THD 102 K Getr. / GBox: G7-EGS ohne Zwischenring / without intermediate ring	(105)		
				3488 013 138 ⊕	350 GMFZ2/350	Chass. 20001 - Chass. 25456 Mot. THD 102 K Getr. / GBox: G7-EGS enthält eine Kupplungsscheibe / This part number includes one clutch disc	(66)		
				1878 001 082	350 10 350GTZ	Chass. 20001 - Chass. 25456 Mot. THD 102 K Getr. / GBox: G7-EGS			
				KFD116B		3400 125 601 ⊕ ⊕ 3483 022 032 ⊕ 1878 003 779	400 10 MFZ400X 400WGTZ	-> Chass. 52525 Getr. / GBox: S6-85	
				KFD117		3483 034 045 ⊕	430 MFZ430	Chass. 52526-> Getr. / GBox: S6-85	
						1878 040 334	430 10 430WGTZ	Chass. 52526-> Getr. / GBox: S6-85	

B 12 01.92 -

B 12				3400 125 601 ⊕ ⊕ 3483 022 032 ⊕ 1878 003 779	400 10 MFZ400X 400WGTZ	Mot. TD 73 E	
				3482 101 032	400 MFZ400X	Mot. TD 73 E In 3483/3488 enthalten / Contained in 3483, 3488	(30)
B 12	01.92 -			3483 034 032 ⊕	430 MFZ430	Mot. TD 122 FH	
				1878 634 026	430 10 430WGTZ	Mot. TD 122 FH	











		CODE					
---	--	------	--	--	---	---	---











VOLVO

















B 12		01.92 -					
B 12	01.92 -			3483 034 032 ⊕	430 MFZ430	Mot. TD 122 FH, FL Getr. / GBox: G7-EGS	
				1878 634 026	430 10 430WGTZ	Mot. TD 122 FH, FL Getr. / GBox: G7-EGS	
				3482 123 235	430 MFZ430	Mot. TD 122 FH, FL Getr. / GBox: G7-EGS In 3483/3488 enthalten / Contained in 3483, 3488	(30)
B 12	01.92 -			3483 034 033 ⊕	430 MFZ430	Mot. D12A420	
				1878 634 026	430 10 430WGTZ	Mot. D12A420	
B 12 M (Chassis)		KFD117E		3400 700 342 ⊕ ⊕ 3483 034 033 ⊕ 1878 000 634	430 24 MFZ430 430WGTZ	Getr. / GBox: EGS-V, EGS-VR	
				3482 123 234	430 MFZ430	Getr. / GBox: EGS-V, EGS-VR In 3483/3488 enthalten / Contained in 3483, 3488	(30)
		KFD117F		3483 034 042 ⊕	430 MFZ430	Getr. / GBox: 6S-1600	
				1878 634 026	430 10 430WGTZ	Getr. / GBox: 6S-1600	
				3482 123 234	430 MFZ430	Getr. / GBox: 6S-1600 In 3483/3488 enthalten / Contained in 3483, 3488	(30)
				3400 700 350 ⊕ ⊕ 3483 034 042 ⊕ 1878 000 634	430 24 MFZ430 430WGTZ	Getr. / GBox: VT2412B	
	3482 123 234		430 MFZ430	Getr. / GBox: VT2412B In 3483/3488 enthalten / Contained in 3483, 3488	(30)		
B 51 - B 59							
B 57, BB 57	01.72 -			3400 037 031 ⊕ 3482 021 031 ⊕ 1878 000 961 ⊕ 3151 600 533	380 10 GM380 380GTZ KZA-4	->Chass. 9780 Mot. TD 70 E, H, HA Getr. / GBox: S6-65	
B 57, BB 57				3482 021 031	380 GM380	Chass. 9781-> Mot. TD 70 E, H, HA Getr. / GBox: S6-65	
				1878 000 961	380 10 380GTZ	Chass. 9781-> Mot. TD 70 E, H, HA Getr. / GBox: S6-65	
				1882 325 134	380 G380	Chass. 1563-> Mot. TD 70 A, B Getr. / GBox: K 191	
				1878 000 961	380 10 380GTZ	Chass. 1563-> Mot. TD 70 A, B Getr. / GBox: K 191	
B 58				1800 107 133 # ⊕ 1882 226 533 ⊕ 1861 672 033 ⊕ 3151 600 534	420 10 G420 420GSZ KZA-4	Mot. THD 100 DD Getr. / GBox: ZF S6-80	
				1800 125 601 # ⊕ 1882 226 533 ⊕ 1861 672 033 ⊕ 3151 105 141	420 G420 420GSZ KZI-5	Mot. D Mot. HD 100A, L/THD 100A, Getr. / GBox: K 191	
B 609 - B 7000							
B 609	12.78 -			3400 116 201 # ⊕ 3482 909 001 ⊕ 1878 076 031 ⊕ 3151 600 535	350 10 MF350 350GTB KZA-4	Mot. TD 60	
B 610	12.78 -						

		CODE					
---	--	------	--	--	---	---	---

VOLVO





















C 10							
C 10 M	01.84-			1800 125 001  1882 250 143  1878 001 079  1878 001 083  3151 600 533  1874 000 098	350 10 GF2/350 350GTZ 350GTZ KZA-4	Mot. THD 101 G, K Getr. / GBox: S6-90 ohne Zwischenring / without intermediate ring	(105)
				 1888 019 445 #	350 GF2/350	Mot. THD 101 G, K Getr. / GBox: S6-90 enthält eine Kupplungsscheibe / This part number includes one clutch disc	(66)
				 1878 001 083 ▽	350 10 350GTZ	Mot. THD 101 G, K Getr. / GBox: S6-90 Lose Kupplungsscheibe / Loose clutch disc	(39)
				 3151 600 533	KZA-4	Mot. THD 101 G, K Getr. / GBox: S6-90	
				 1859 170 204	350 GF2/350	Mot. THD 101 G, K Getr. / GBox: S6-90 In 1888 enthalten / Contained in 1888	(29)

8500							
8500 8500 8500				3400 700 342 ⊕  3483 034 033  1878 000 634	430 24 MFZ430 430WGTZ	Getr. / GBox: EGS-VR	
				 3482 123 234	430 MFZ430	Getr. / GBox: EGS-VR In 3483/3488 enthalten / Contained in 3483, 3488	(30)
				 3400 700 350 ⊕  3483 034 042  1878 000 634	430 24 MFZ430 430WGTZ	Getr. / GBox: VT-2412B (I-Shift)	
				 3483 034 042 ⊕	430 MFZ430	Getr. / GBox: ZF 6S-1600	
				 1878 634 026	430 10 430WGTZ	Getr. / GBox: ZF 6S-1600	
				 3482 123 234	430 MFZ430	Getr. / GBox: ZF 6S-1600 Getr. / GBox: VT-2412B (I-Shift) In 3483/3488 enthalten / Contained in 3483, 3488	(30)

8700							
8700 8700 8700				3400 700 342 ⊕  3483 034 033  1878 000 634	430 24 MFZ430 430WGTZ	Getr. / GBox: EGS-VR	
				 3482 123 234	430 MFZ430	Getr. / GBox: EGS-VR In 3483/3488 enthalten / Contained in 3483, 3488	(30)
				 3400 700 350 ⊕  3483 034 042  1878 000 634	430 24 MFZ430 430WGTZ	Getr. / GBox: VT-2412B (I-Shift)	
				 3483 034 042 ⊕	430 MFZ430	Getr. / GBox: ZF 6S-1600	
				 1878 634 026	430 10 430WGTZ	Getr. / GBox: ZF 6S-1600	
				 3482 123 234	430 MFZ430	Getr. / GBox: ZF 6S-1600 Getr. / GBox: VT-2412B (I-Shift) In 3483/3488 enthalten / Contained in 3483, 3488	(30)
8700				3400 127 201 ⊕  3483 034 033  1862 530 231	430 10 MFZ430 430WGTZ	->Chass. 6485 Getr. / GBox: EGS-VR	
				 3483 034 033 ⊕	430 MFZ430	Chass. 6486-> Getr. / GBox: EGS-VR	
				 1878 001 215	430 24 430WGTZ	Chass. 6486-> Getr. / GBox: EGS-VR	
				 3482 123 234	430 MFZ430	Getr. / GBox: EGS-VR In 3483/3488 enthalten / Contained in 3483, 3488	(30)













		CODE				
---	--	------	--	---	---	---

VOLVO



9700		04.01 -					
9700	04.01 -		 3400 700 342 ⊕ ⊗ 3483 034 033 ⊗ 1878 000 634	430 24 MFZ430 430WGTZ	Getr. / GBox: EGS-VR		
9700	10.01 -						
9700	04.01 -		 3482 123 234	430 MFZ430	Getr. / GBox: EGS-VR In 3483/3488 enthalten / Contained in 3483, 3488	(30)	
9700	10.01 -						
9700	04.01 -		 3400 700 350 ⊕ ⊗ 3483 034 042 ⊗ 1878 000 634	430 24 MFZ430 430WGTZ	Getr. / GBox: VT-2412B (I-Shift)		
9700	10.01 -		 3483 034 042 ⊕	430 MFZ430	Getr. / GBox: ZF 6S-1600		
			 1878 634 026	430 10 430WGTZ	Getr. / GBox: ZF 6S-1600		
			 3482 123 234	430 MFZ430	Getr. / GBox: ZF 6S-1600 Getr. / GBox: VT-2412B (I-Shift) In 3483/3488 enthalten / Contained in 3483, 3488	(30)	
9700	10.07 -		 3400 710 060 ⊗ 3482 000 552 ⊗ 1878 003 867 ⊗ 6482 000 155	430 24 MF430 430WGTZ PHIS-6/38	Mot. DH12E460		
9700	10.07 -		 1863 869 037	72	Mot. DH12E460		
9700	01.09 -		 3400 710 061 ⊗ 3482 000 553 ⊗ 1878 006 129 ⊗ 6482 000 155	430 24 MF430 430WGTZ PHIS-6/38	Mot. D12C420		
9700	01.09 -		 3400 710 061 ⊗ 3482 000 553 ⊗ 1878 006 129 ⊗ 6482 000 155	430 24 MF430 430WGTZ PHIS-6/38	Mot. D12C460		
9900		10.01 -					
9900	10.01 -		 3400 700 342 ⊕ ⊗ 3483 034 033 ⊗ 1878 000 634	430 24 MFZ430 430WGTZ	Mot. DH12D420 Getr. / GBox: EGS-VR		
9900	10.01 -		 3482 123 234	430 MFZ430	Mot. DH12D420 Getr. / GBox: EGS-VR In 3483/3488 enthalten / Contained in 3483, 3488	(30)	
			 3482 123 234	430 MFZ430	Mot. DH12D420 Getr. / GBox: VT-2412B (I-Shift) In 3483/3488 enthalten / Contained in 3483, 3488	(30)	
			 3400 700 350 ⊕ ⊗ 3483 034 042 ⊗ 1878 000 634	430 24 MFZ430 430WGTZ	Mot. DH12D420 Getr. / GBox: VT-2412B (I-Shift)		
			 3483 034 033 ⊕	430 MFZ430	Mot. DH12D420 Getr. / GBox: EGS-VR		
			 3483 034 042 ⊕	430 MFZ430	Mot. DH12D420 Getr. / GBox: VT-2412B (I-Shift)		
			 1878 000 634	430 24 430WGTZ	Mot. DH12D420 Getr. / GBox: VT-2412B (I-Shift) Getr. / GBox: EGS-VR		
			 3100 026 434 ⊕ 3151 000 163 ⊗ 3180 000 009	KZIZ-5 KZISZ-5	Mot. DH12D420 Getr. / GBox: EGS-VR Beinhaltet Ausrücker und Montagesatz / Contains releaser and fitting kit In 3483/3488 enthalten / Contained in 3483, 3488	(14) (30)	
			 3100 026 431 ⊕ 3151 000 154 ⊗ 3180 000 009	KZISZ-5	Mot. DH12D420 Getr. / GBox: VT-2412B (I-Shift) für Membranfederinnendurchmesser 120mm / for diaphragm spring inside diameter 120mm Beinhaltet Ausrücker und Montagesatz / Contains releaser and fitting kit In 3483/3488 enthalten / Contained in 3483, 3488	(79) (14) (30)	
			 3100 026 432 ⊕ 3151 000 154 ⊗ 3180 001 008	KZIZ-5 KZISZ-5	Mot. DH12D420 Getr. / GBox: VT-2412B (I-Shift) für Membranfederinnendurchmesser 100mm / for diaphragm spring inside diameter 100mm Beinhaltet Ausrücker und Montagesatz / Contains releaser and fitting kit In 3483/3488 enthalten / Contained in 3483, 3488	(78) (14) (30)	

		CODE				
---	--	------	--	---	---	---

VOLVO

9900		10.01 -					
9900	01.09-			3400 710 061	430 24	Mot. D12C420	
9900	01.09-			 3482 000 553  1878 006 129  6482 000 155	MF430 430WGTZ PHIS-6/38		
9900	10.07-			3400 710 060	430 24	Mot. DH12E460	
9900	10.07-			 3482 000 552  1878 003 867  6482 000 155	MF430 430WGTZ PHIS-6/38		
				1863 869 037	72	Mot. DH12E460	
9900	01.09-			3400 710 061	430 24	Mot. D12C460	
9900	01.09-			 3482 000 553  1878 006 129  6482 000 155	MF430 430WGTZ PHIS-6/38		

YUTONG

ZK							
ZK 6100 HB		C245-20		3482 124 549	430	Getr. / GBox: Qijiang QJ805	
ZK 6118 HGA				1878 026 241	430 10	Getr. / GBox: Qijiang QJ1205	
					GMF430	Getr. / GBox: Qijiang QJ805	
					430WGTZ	Getr. / GBox: Qijiang QJ1205	
ZK 6120 HA		CumminsC30020		3482 124 549	430	Getr. / GBox: ZF S6-90	
				1878 026 241	430 10	Getr. / GBox: ZF S6-90	
					GMF430		
					430WGTZ		
ZK 6831 HE		EQB210-20		3482 000 464	395	Getr. / GBox: Qijiang QJ805	
				1878 000 294	395 10	Getr. / GBox: Qijiang QJ805	
					MF395		
					395WGTZ		

Artikelnummer Article No.	Seite Page	Hersteller Manufacturer	Artikelnummer Article No.	Seite Page	Hersteller Manufacturer
1861 224 005 # (1 1/8"-10N)	31	FAUN	1861 571 236 (28x35-10N)	474 475 479 480 485 488 495 496 814	MERCEDES-BENZ NEOPLAN
1861 279 133 (28x35-10N)	340 346 469 470 473 475 476 479 484 485 488 510 774 795	MERCEDES-BENZ	1861 572 431 (2"-10N)	115 740	IVECO
1861 280 136 (18,3x20,4-24N)	33	FAUN	1861 574 132 # (18,3x20,4-24N)	459	MERCEDES-BENZ
1861 291 136 (26x32-10N)	31 339 342 343 345 346 462 463 464 465 781 793	FAUN MERCEDES-BENZ	1861 577 037 # (1 1/2"-10N)	68 106 123 302 305 611 629 632 646 647	IVECO MAGIRUS-DEUTZ MAN RENAULT TRUCKS
1861 303 248 (28x35-10N)	725 735 118 347 348 349 463 464 466 467 468 470 471 472 473 474 475 476 478 479 480 484 485 487 488 493 495 496 510 769 770 772 773 774 775 794 795 806 807 810 814	EVOBUS IKARUS KÄSSBOHRER MERCEDES-BENZ	1861 577 136 # (1 1/2"-10N)	76 77 106 125	IVECO MAGIRUS-DEUTZ
1861 351 342 # (32x40-10N)	125 126 742 743 744	MAGIRUS-DEUTZ	1861 594 034 # (36x40-20N)	441 442 443 444 450	MERCEDES-BENZ
1861 384 334 # (26x32-10N)	423 424 425 426 427 428 429 434 435 436 438 439 440	MERCEDES-BENZ	1861 600 033 # (32x40-10N)	122 123 124 200 667	MAGIRUS-DEUTZ MAN TAM
1861 410 047 # (36x45-10N)	728 503 526 533 538 541 809	EVOBUS MERCEDES-BENZ NEOPLAN	1861 603 034 # (36x40-20N)	437	MERCEDES-BENZ
1861 421 032 # (18,3x20,4-24N)	458 459	MERCEDES-BENZ	1861 611 131 # (26x32-10N)	423 424 425 426 427 428 434 436 439	MERCEDES-BENZ
1861 470 234 (32x40-10N)	121 126 200 300 301 304 763 779 780 795	MAGIRUS-DEUTZ MAN MERCEDES-BENZ	1861 632 032 (28x35-10N)	343 346 781 794	MERCEDES-BENZ
1861 479 032 # (32x40-10N)	81 107 123 124 126	IVECO MAGIRUS-DEUTZ	1861 643 134 # (1 3/4"-10N)	77 78 79 481 482 490 499 501 520 521 522 523 536 537 538 539 556	IVECO MERCEDES-BENZ
1861 518 031 # (26x32-10N)	423 424 425 426 427 428 434 436 439	MERCEDES-BENZ	1861 653 132 (1 1/2"-10N)	740 742	IVECO MAGIRUS-DEUTZ
1861 526 046 (1 3/4"-10N)	146 306 309 315 317 318 320 322	MAN	1861 667 034 (36x40-20N)	440 441 442 443 444 448 449 450	MERCEDES-BENZ
1861 557 236 # (23x27-10N)	339 340 341 342 343 344 345 346 458 462 781	MERCEDES-BENZ	1861 672 033 (36x44,5-10N)	678 679 680 713 714 715 717 718 839 840 841 842	VOLVO
1861 571 110 # (1 3/4"-10N)	728 729	EVOBUS	1861 713 133 # (36x40-20N)	441 444 445 446 447 448 449 450	MERCEDES-BENZ
			1861 741 042 # (36x40-20N)	426 427 428 429 435 437 440 441 442 443 444 447 448 449 450	MERCEDES-BENZ
			1861 742 032 (1 1/2"-10N)	68 76 77 82 106 107 124	IVECO MAGIRUS-DEUTZ
			1861 748 132 (63,6x73,5-6N)	307 310 311 313 314 316 317 318 319 321 322 323	MAN
			1861 749 132 (1 3/4"-10N)	307 310 311 313 314 316 317 318 319 321 322 323	MAN
			1861 777 037 (1 1/2"-10N)	2 3 4 14	DAF

Arithmetische Liste / Part number list

Artikelnummer Article No.	Seite Page	Hersteller Manufacturer	Artikelnummer Article No.	Seite Page	Hersteller Manufacturer
1861 777 041 # (1 1/2"-10N)	190 745 805	MAN NEOPLAN	1861 988 034 (36x44,5-10N)	681 694	VOLVO
1861 777 043 (1 3/4"-10N)	3 4 6 17	DAF	1861 988 040 (2"-10N)	674 681 694 695 696 716 841	VOLVO
1861 799 133 (41x45-22N)	650	SCANIA	1861 992 432 (2"-10N)	101 102 112 113 116 133	IVECO MAGIRUS-DEUTZ
1861 840 133 # (26x32-10N)	423 428 431 432 433 438	MERCEDES-BENZ	1861 996 137 (2"-10N)	675 676 717 719	VOLVO
1861 841 132 (27x29,4-28N)	189 190 745	MAN	1861 997 137 (2"-10N)	676 717 719	VOLVO
1861 874 032 (1 1/2"-10N)	728 740 742	EVOBUS IVECO MAGIRUS-DEUTZ	1862 039 015 # (26x32-10N)	31 122	FAUN MAGIRUS-DEUTZ
1861 876 134 # (1 3/4"-10N)	306 307 309 310 315 318 319 321 323	MAN	1862 088 131 (26x32-10N)	427 431	MERCEDES-BENZ
1861 897 034 (21,9x24,2-23N)	668 669 670 672 673 836	VOLKSWAGEN	1862 122 132 (2"-10N)	504 524 529 530 542 564 579 586 589 590 592 798 805	MERCEDES-BENZ NEOPLAN MAGIRUS-DEUTZ
1861 902 032 # (1 3/4"-10N)	30 725 654	ENASA SISU	1862 123 131 (2"-10N)	504 524 529 530 542 564 579 586 589 590 592 798 805	MERCEDES-BENZ NEOPLAN
1861 907 132 (2"-10N)	675 717	VOLVO	1862 125 202 # (1 3/4"-10N)	655 656 657	STEYR
1861 911 232 (1 3/4"-10N)	730 731 307 310 311 313 314 316 317 318 319 321 322 323 324 325 753 760	EVOBUS MAN	1862 135 035 (2"-10N)	724 503 504 526 527 533 541 560 574 575 576 579 580 582 583	DRÖGMÖLLER MAGIRUS-DEUTZ MAGIRUS-DEUTZ
1861 919 134 (28x35-10N)	340 343 346 347 348 349 460 463 464 465 466 467 468 469 470 471 472 473 475 476 478 488 769 772 773 781 782 796	MERCEDES-BENZ	1862 138 032 (2"-10N)	724 503 504 526 527 533 541 560 574 575 576 579 580 582 583	DRÖGMÖLLER MAGIRUS-DEUTZ
1861 923 032 # (1 3/4"-10N)	796	MERCEDES-BENZ	1862 208 032 (2"-10N)	30	ENASA
1861 936 142 (23x29-10N)	347 348 462	MERCEDES-BENZ	1862 211 031 # (1 3/4"-10N)	786 787 788	MERCEDES-BENZ
1861 956 133 (36x40-20N)	441 444 445 446 447 448 449 450	MERCEDES-BENZ	1862 219 031 (27x29,4-28N)	189 190 745 746	MAN
1861 963 033 (28x35-10N)	468 469 472 476 477 480 485 486 487 493 773 784 793 794	MERCEDES-BENZ	1862 225 132 # (1 3/4"-10N)	481 482 483 490 491 507 520 543	MERCEDES-BENZ
1861 964 034 (28x35-10N)	468 472 476 479 485 486 488 493 495 510 773 784 793 794 799	MERCEDES-BENZ NEOPLAN	1862 244 032 (1 1/2"-10N)	201 202 203 204	MAN
1861 966 141 # (26x32-10N)	424 425 426 427 428 429 433 434 435 436 438 439 440	MERCEDES-BENZ	1862 248 033 Δ (88,5x102-8N)	676 683 684 685 686 697 700 702 703 705 706 708 709 710 711 717 719	VOLVO
1861 973 032 # (1 3/4"-10N)	104 110 113	IVECO	1862 268 031 (1 3/4"-10N)	507 508 521 543 544 545 546 548 549 558 566 567 575 580	MERCEDES-BENZ
			1862 286 031 # (36x40-20N)	445 446 447 450 451 452	MERCEDES-BENZ

Artikelnummer Article No.	Seite Page	Hersteller Manufacturer	Artikelnummer Article No.	Seite Page	Hersteller Manufacturer
1862 299 032 (28x35-10N)	347 349 464 465 469 793	MERCEDES-BENZ	1862 317 031 (1 3/4"-10N)	70 72 73 74 84 93 95	IVECO
1862 302 031 (102,4x88-8N)	835	VAN HOOL	1862 317 032 (2"-10N)	69 71 72 73	IVECO
1862 303 031 (2"-10N)	135 137 138 139 140 141 142 143 144 145 146 147 148 149 150 151 152 153 154 155 156 157 158 163 164 167 168 600	MAN	1862 328 031 (41x45-22N)	651 828	SCANIA
	835	ÖSTERREICHISCHE AUTOMOBILFABRIK (ÖAF) VAN HOOL	1862 349 031 (2"-10N)	147 694 695 696 712	MAN VOLVO
1862 304 033 (2"-10N)	81 508 509 510 512 513 514 515 516 517 518 524 525 526 527 529 530 531 532 534 535 541 544 545 546 548 549 550 551 552 553 554 557 558 559 560 561 562 563 565 567 570 571 572 573 576 581 582 583 585 586 587 588 590 592 593	IVECO MERCEDES-BENZ	1862 353 041 ▲ (29x35-10N)	611 634 641 642 644 645 646	RENAULT TRUCKS
			1862 364 031 (2"-10N)	134 135 136 137 139 140 141 142 143 144 145 146 147 148 149 150 151 152 153 154 155 157 158 159 160 161 162 163 164 165 166 167 168 169 170 171 208 324 598 599 600 601	MAN ÖSTERREICHISCHE AUTOMOBILFABRIK (ÖAF)
			1862 364 133 (1 3/4"-10N)	133 134 135 136 137 138 140 145 146 147 148 149 150 151 157 159 160 161 165 169 324 745 759 760	MAN
1862 305 033 (2"-10N)	81 508 509 510 512 513 514 515 516 517 518 524 525 526 527 529 530 531 532 534 535 544 545 546 548 549 550 551 552 553 554 557 558 559 560 561 562 563 565 570 571 572 573 581 582 583 585 586 587 588 590 592 593	IVECO MERCEDES-BENZ	1862 375 031 (23,3x26,3-23N)	326 327 764	MERCEDES-BENZ
			1862 379 031 (50x55-20N)	605 606 614 615 616 617 619 620 621 624 628 636 637 654	RENAULT TRUCKS SISU
			1862 379 032 (2"-10N)	613 614 615 616 617 618 619 620 621 622 623 636 637 638 639	RENAULT TRUCKS
			1862 408 031 # (26x32-10N)	428 429 430	MERCEDES-BENZ
			1862 415 031 ▽ (2"-10N)	676 683 684 685 686 697 708 709 710 711 717 719	VOLVO
1862 308 031 (1 3/4"-10N)	61 63 65 66 67 68 70 72	IVECO	1862 438 032 (1 1/2"-10N)	190 191 192 193 194 195 198 199 201 202 203 204 208 209 210 211	MAN
1862 310 132 (1 1/2"-10N)	57 59 61 63 64 65 66 67 68	IVECO		654 655 656 657 658	STEYR
1862 315 101 # (2"-10N)	659 660 661	STEYR			

Arithmetische Liste / Part number list

Artikelnummer Article No.	Seite Page	Hersteller Manufacturer	Artikelnummer Article No.	Seite Page	Hersteller Manufacturer
1862 441 131 # (2"-10N)	172 175 176 179 180 181 182 183 184 185 186 187 189 596 597 598	MAN	1863 101 100 ▲	742 743 744	MAGIRUS-DEUTZ
1862 450 031 (41x45-22N)	651 660 661	ÖSTERREICHISCHE AUTOMOBILFABRIK (ÖAF) STEYR	1863 600 116	594	NISSAN
1862 506 131 (1 3/4" -10N)	172 191 207 208 209 210 211 212 213 214 236 249 251 252 253 254 255 256 325 326 806 656 657 658 660 832 833 833	MAN MAZ NEOPLAN STEYR TAM TEMSA	1863 600 123	601 602	ÖSTERREICHISCHE AUTOMOBILFABRIK (ÖAF)
1862 530 231 (2"-10N)	674 695 696 707 716 718 839 841 843	VOLVO	1863 805 001	13 14 796 797	DAF MITSUBISHI
1862 543 031 (2"-10N)	34	HINO	1863 837 002	426 427 428 429 430 431 432 433 434 435 436 437 439 440 441 442 444 445 446 447 448 449 450 452 453	MERCEDES-BENZ
1862 642 001 (24,5x29-10N)	14	DAF	1863 837 003	423 424 425 426 432 433 434 435 436 437 441 442	MERCEDES-BENZ
1862 718 002 # (26x32-10N)	423 432 433 434 435 437 441 442	MERCEDES-BENZ	1863 840 001	423 424 425 426 427 428 429 431 432 433 434 435 436 438 439 440	MERCEDES-BENZ
1862 767 001 (18,3x20,4-24N)	2 722	BARKAS	1863 855 000	426 427 428 429 430 431 432 433 435 437 440 441 442 444 445 446 447 448 449 450 452 453	MERCEDES-BENZ
1862 788 001 (23,3x26,2-23N)	13 14	DAF	1863 869 002	668 669 670 672 673 836 837	VOLKSWAGEN
1862 811 001 (26x32-10N)	50 104 105 739	IVECO	1863 869 005	670 671 672 837 838	VOLKSWAGEN
1862 851 002 (23,1x26-23N)	797	MITSUBISHI	1863 869 010	327 328 329 330 331 332 333 334 335 336 337 339 340 343 346 347 348 349 351 352 423 431 432 433 765 766 767 769 781	MERCEDES-BENZ
1862 862 002 (23x26-23N)	797	MITSUBISHI	1863 869 012	328 329 330 332 335 336 338 339 351 765 767 769 668 836	MERCEDES-BENZ
1862 962 002 # (36x40-20N)	443 444 445 446 447 448 449 450 451 452 453 454	MERCEDES-BENZ	1863 869 028	366 368 369 372 375 376 379 381 385 387 390 392 417 419 420 421 783 784 790 791 792 830 831 832	VOLKSWAGEN MERCEDES-BENZ
1862 967 001 (23x29-10N)	34 35 36 37 38 40 41 738	IVECO	1863 869 037	618	RENAULT TRUCKS
1862 973 002 (30,9x38,1-10N)	76 692	IVECO VOLVO			
1862 974 002 (1 3/4"-10N)	681 692 693	VOLVO			
1862 977 001 (23x29-10N)	34 35 38 39	IVECO			
1863 009 100	31 32 33 735 754 763 764 822	FAUN IKARUS MAN ÖSTERREICHISCHE AUTOMOBILFABRIK (ÖAF)			
1863 010 100	121 126 461 498 518	MAGIRUS-DEUTZ MERCEDES-BENZ			
1863 100 030	30	DEMAG			

Artikelnummer Article No.	Seite Page	Hersteller Manufacturer	Artikelnummer Article No.	Seite Page	Hersteller Manufacturer
1863 869 038	205 219 220	MAN	1866 000 021	120	LIEBHERR
	221 222 223		(41x45-21N)		
	224 225 226		1866 000 062	119	LIEBHERR
	227 228 230		(36x40-18N)		
	231 232 233		1866 000 079	120	LIEBHERR
	234 257 258		(36x40 -18N)		
	259 260 261		1866 000 140	720	VOLVO PENTA
	262 263 264		(31,8x34,3-26N)		
	265 266 267		1866 000 151	120 121	LIEBHERR
	268 269 270		(46x50-24N)		
	271 272 273		1866 000 152	121	LIEBHERR
	274 275 276		(64x70-22N)		
	277 278 279		1866 000 239	720 721	VOLVO PENTA
	280 281 282		(31,8x34,3-26N)		
	283 284 285		1866 018 131	719 720	VOLVO PENTA
	286 287 288		(31,8x34,3-26N)		
	289 290 291		1866 030 102	627	RENAULT TRUCKS
	292 293 294		(64x70-32N)		
	295 296 297		1866 032 231	719 720 721	VOLVO PENTA
	298 299		(31,8x34,3-26N)		
799 800 815	1866 065 001	120 121	LIEBHERR		
816 817 818	(41x45-22N)				
819 820 821	1866 090 001	121	LIEBHERR		
822	(54x60-18N)				
1863 869 039	697	VOLVO	1866 118 001	720 721	VOLVO PENTA
1863 869 041	602	RENAULT TRUCKS	(31,8x34,3-26N)		
1863 869 042	247 248 249	MAN	1866 133 001	119 120	LIEBHERR
	250 251 252		(36x40-18N)		
	253 254 255		1866 135 001	120 121	LIEBHERR
	256		(46x50-24N)		
1864 202 035 #	30	DEMAG	1866 136 001	119 120	LIEBHERR
(26x32-10N)	118 119 120	LIEBHERR	(31x35-16N)		
1864 347 102 #	662 663	STEYR	1866 148 001	121	LIEBHERR
(41x45-22N)			(64x70-22N)		
1864 351 005 ▲	611 646	RENAULT TRUCKS	1866 156 001	119 120	LIEBHERR
(1 3/4"-10N)			(36x40-18N)		
1864 454 101	610	RENAULT TRUCKS	1866 157 101	120	LIEBHERR
(1 1/2"-10N)			(46x50-24N)		
1864 464 031	351 352	MERCEDES-BENZ	1866 157 103	119	LIEBHERR
(26,5x28,7-26N)			(46x50-24N)		
1864 497 042	611 635 645	RENAULT TRUCKS	1874 000 006	327 329 331	MERCEDES-BENZ
	(50x56-20N)		332 333 334		
	1864 497 043		607 609 610	335 337 338	
	(40x45-16N)		611 644 645	766 767 768	
	647		1874 000 098	673 674 675	VOLVO
1864 503 231	327 329 331	MERCEDES-BENZ	677 679 714	715 717 718	
(26,5x28,7-26N)	332 335 351		841 842 843		
	766 767		1874 015 200	79 80 81	IVECO
1864 504 031	328 330 331	MERCEDES-BENZ	83 108 109	110 111 112	
(26,5x28,7-26N)	333 335 337		113 114 116	117 739 740	
	455 456 457		133		MAGIRUS-DEUTZ
	766 767 772		1878 000 036	15 16 18	DAF
	793		(1 1/2"-10N)	738	IVECO
1864 509 041	826	RENAULT TRUCKS	1878 000 104	32 33	FAUN
(36x45-10N)			(36x45-10N)	113 114 115	IVECO
1864 523 441	606 607 609	RENAULT TRUCKS		121 126 127	MAGIRUS-DEUTZ
(40x45-16N)	610 635 644			128 130 131	
	647			491 497 498	MERCEDES-BENZ
1864 528 442	670 671 672	VOLKSWAGEN		499 500 501	
(26,5x28,9-26N)	837 838			519 521 522	
1864 634 026	30	DEMAG		530 531 537	
(26x32-10N)					
1866 000 007	120	LIEBHERR			
(54x60-18N)					

Arithmetische Liste / Part number list

Artikelnummer Article No.	Seite Page	Hersteller Manufacturer	Artikelnummer Article No.	Seite Page	Hersteller Manufacturer
1878 000 105 (1 3/4"-10N)	723 5 6 7 8 19 724 119	BOVA DAF	1878 000 959 ▲ (36x45-10N)	1	ASTRA
	475 477 478	LIEBHERR	1878 000 960 (40x45-16N)	602	RENAULT TRUCKS
	480 481 482	MERCEDES-BENZ	1878 000 961 (1 3/4"-10N)	673 681 691 692 693 714 838 839 842	VOLVO
	483 487 490		1878 000 964 (1 3/4"-10N)	119 205 206 207 212 213 303 304 306 307 310 313 321 324 481 497 500 505 506 518 519 535 538 556 574 577 582 591 678 679 680 713 714 715 716	LIEBHERR MAN
	491 492 494				MERCEDES-BENZ
	497 498 499				VOLVO
	500 501 505				
	506 507 518				
	519 520 521				
	522 531 536				
	537 538 539				
	540 543 555				
	556 780 794				
	801	NEOPLAN			
1878 000 205 (2"-10N)	118	KAMAZ	1878 000 965 (2"-10N)	674 675 715 716	VOLVO
1878 000 206 (1 3/4"-10N)	117 118	KAMAZ	1878 000 967 (1 3/4"-10N)	119 307 310 313 321 324 677 678 679 680 713 714 715 716	LIEBHERR MAN
1878 000 294 (1 3/4"-10N)	15 16 741 845	DAF KING LONG YUTONG	1878 000 968 (2"-10N)	2 724 731 732 502 504 528 529 533 541 542 546 557 559 561 563 568 569 576 577 578 584 589 590 654 674 675 715 716	VOLVO
1878 000 296 (1 3/4"-10N)	18 20 21	DAF			LIEBHERR MAN
1878 000 298 (2"-10N)	736 737	IRISBUS			VOLVO
1878 000 300 (46x50-24N)	685 686 687 690 708 709 710 711 718	VOLVO			DAEWOO DRÖGMÖLLER EVOBUS MERCEDES-BENZ
1878 000 515 (1 1/2"-10N)	1 2	AVIA			
1878 000 611 (1 1/2"-10N)	53 55 56 57 58 59 60 61 62 63 64 65 66 68 104 105 106 107 739 631 632 634	IVECO			SCANIA VOLVO
1878 000 615 (26,48x28,7-26N)	459	RENAULT TRUCKS MERCEDES-BENZ	1878 001 070 (1 3/4"-10N)	3 4 5 6 7 14 68 81 82 107 108 119 123 124 125 126 128 129 475 477 478 480 481 482 485 487 489 490 494 496 497 498 505 506 511 530 535 536 543 794 795 806 807 810 815	DAF
1878 000 634 (46x50-24N)	620 622 685 686 699 701 707 708 709 710 711 718 840 842 843 844	RENAULT TRUCKS VOLVO			IVECO
1878 000 635 (85x98-8N)	685 686 687 708 709 710 711	VOLVO			LIEBHERR MAGIRUS-DEUTZ
1878 000 650 (1 3/4"-10N)	750 754	MAN			MERCEDES-BENZ
1878 000 841 # (1 1/2"-10N)	745 750 752 757 758	MAN			
1878 000 957 (1 3/4"-10N)	68 76 77 78 79 82 83 107 108 109 110 114 740 741 126 127 128 129 744 201 202 203	IVECO			NEOPLAN
		MAGIRUS-DEUTZ	1878 001 071 (1 1/2"-10N)	3 4 5 14 723 724	DAF
		MAN	1878 001 074 (32x40-10N)	31 121 122 123	FAUN MAGIRUS-DEUTZ

Artikelnummer Article No.	Seite Page	Hersteller Manufacturer	Artikelnummer Article No.	Seite Page	Hersteller Manufacturer
1878 001 077 (1 1/2"-10N)	125 197 198 199 201 202 203 204 205 206 207 300 757 758 806 655 656	MAGIRUS-DEUTZ MAN NEOPLAN STEYR	1878 001 145 (1 1/2"-10N)	197 198 199 300 750 757 758 629 630 632 633 635 655 656	MAN RENAULT TRUCKS STEYR
1878 001 079 (1 3/4"-10N)	303 305 308 629 677 678 679 680 713 715 717 718 841 842 843	MAN RENAULT TRUCKS VOLVO	1878 001 147 # (1 3/4"-10N)	299 300 301 302 303 304 305 308 310 312 763 776 642	MAN MERCEDES-BENZ RENAULT TRUCKS
1878 001 080 (2"-10N)	673 674 676 694 695 696 714 715 716 717 718 841	VOLVO	1878 001 152 (1 3/4"-10N)	727 728 729 734 743 744 745 201 202 203 204 205 206 207 208 301 302 303 304 305 306 308 309 310 311 312 313 314 315 317 318 320 322 752 754 759 505 506 511 777 778 801 802 642 657 658 659 663 664 667 832 835	EVOBUS MAGIRUS-DEUTZ MAN
1878 001 082 (2"-10N)	673 674 676 694 695 696 714 715 716 717 718 841	VOLVO	1878 001 154 # (1 3/4"-10N)	743 744 745 751 752 754 755 756	MAGIRUS-DEUTZ MAN
1878 001 083 (1 3/4"-10N)	673 677 678 679 680 713 714 715 717 718 841 842 843	VOLVO	1878 001 155 ▲# (36x45-10N)	301 306 309 312 315 318 754 763 764 595 596 598 822 643	MAN ÖSTERREICHISCHE AUTOMOBILFABRIK (ÖAF) RENAULT TRUCKS
1878 001 136 (1 3/4"-10N)	1 520 538 555 556 779 780 786 787 788 801 643 644 833	ASTRA MERCEDES-BENZ NEOPLAN RENAULT TRUCKS VAN HOOL	1878 001 215 (46x50-24N)	698 707 839 843	MERCEDES-BENZ MAGIRUS-DEUTZ
1878 001 138 (1 3/4"-10N)	8 14 21 723 735 77 78 79 82 83 108 109 110 111 112 113 114 115 116 117 739 740 128 129 131 132 133 798 800 803 809 815 647 648 649 826 833 834	DAF IKARUS IVECO MAGIRUS-DEUTZ NEOPLAN SCANIA VAN HOOL	1878 001 216 (46x50-24N)	681 682 683 685 686 698 700 701 702 703 704 705 706 708 709 710 711 712	MAN RENAULT TRUCKS VOLVO
1878 001 144 (1 3/4"-10N)	299 300 301 302 303 304 305 308 310 312 763 469 477 486 488 489 490 494 496 497 498 505 511 536 776 794 795 642 656 657 658 662 663 664	MAN MERCEDES-BENZ RENAULT TRUCKS STEYR	1878 001 501 (1 1/2"-10N)	823	PAZ
			1878 001 709 (1 3/4" -10N)	833	TEMSA
			1878 001 713 (1"-10N)	602 628	RENAULT TRUCKS
			1878 001 727 (1 1/2" -10N)	631 632	RENAULT TRUCKS
			1878 001 729 (1 1/2"-10N)	606 607 609 610 611 625 629 630 632 633 634 646 647 823	RENAULT TRUCKS

Arithmetische Liste / Part number list

Artikelnummer Article No.	Seite Page	Hersteller Manufacturer	Artikelnummer Article No.	Seite Page	Hersteller Manufacturer				
1878 001 939 (36x40-18N)	394 396 397	MERCEDES-BENZ	1878 002 460 △ (2"-10N)	677 688 689	VOLVO				
	399 401 403			1878 002 599 (1 1/2"-10N)		117	KAMAZ		
	404 407 410		1878 002 642 (1 3/4"-10N)		117	KAMAZ			
	430 431 454				1878 002 643 (2"-10N)			173 178 182	MAN
	455 456 457							184 185 187	
	464 465 468							188 189 217	
	469 472 477		218 219 235						
	486 493 772		237 238 239						
793 794	240 241 242								
1878 002 019 (45x50-18N)	366 367 369	MERCEDES-BENZ	243 244 245						
	370 372 373		246 247 257						
	375 376 379		258 259 260						
	381 384 385		261 262 263						
	386 387 388		264 265 266						
	390 391 392		267 268 269						
	393 421 563		270 271 272						
	1878 002 023 (85x96-8N)		173 178 182	MAN	273 274 275				
184 185 188		276 277 278							
659 662		279 280 281							
1878 002 024 (45x50-18N)	365 366 367	MERCEDES-BENZ	282 283 284						
	368 369 370		285 286 287						
	371 372 373		288 289 290						
	374 375 376		291 292 293						
	378 379 380		294 295 296						
	381 382 383		297 298 299						
	384 385 386		659 662 666						
	387 388 389		667						
	390 391 392		836						
	393 394 419		STEYR	VAN HOOL					
	420 421								
	1878 002 071 (1 3/4"-10N)		17	DAF	1878 002 706 (1 3/4" -10N)	723	BOVA		
117		11 12 13	DAF						
721		21							
1878 002 072 (23x29-10N)	34 35 36	IVECO		724	DRÖGMÖLLER				
	37 38 39		728	EVOBUS					
	40 41 42		32			FAUN			
	43 44 738		130				MAGIRUS-DEUTZ		
	739		310 752 753					MAN	
1878 002 075 # (40x45-16N)	607 629 630	RENAULT TRUCKS	755		MERCEDES-BENZ				
	633 825		481 482 483						
	1878 002 139 (2" -10N)		228 229 230	MAN		490 491 492			
231 232 233		499 500 501							
234 235 236		502 503 520							
240 241 242		521 522 523							
243 244 245		525 526 528							
246 247 260		532 533 536							
262 263 265		537 538 539							
269 270 273		540 541 542							
276 282 289		544 550 556							
290 292 295		557 558 559							
298 746 749		561 566 567							
817		568 569 570							
666	571 574 575								
1878 002 437 (2"-10N)	686 688 689	VOLVO	576 577 578						
	691 708 709		579 580 582						
	710 711		583 584 589						
1878 002 442 (85x98-8N)	688 689 691	VOLVO	590 591 787						
	1878 002 455 (50x55-20N)		621	RENAULT TRUCKS	788				
1878 002 458 ▽ (2"-10N)		677 688 689	VOLVO		801 802 803				
		1878 002 458 ▽ (2"-10N)			677 688 689	VOLVO	804 805 806		
677 688 689	807 808 809								
677 688 689	810 811 812								
677 688 689	NEOPLAN								
677 688 689									

Artikelnummer Article No.	Seite Page	Hersteller Manufacturer	Artikelnummer Article No.	Seite Page	Hersteller Manufacturer
1878 002 731 (45x50-18N)	412 413 414 415 416 419 420 422	MERCEDES-BENZ	1878 003 274 (42x52-10N)	114 116 117 131 132	IVECO MAGIRUS-DEUTZ
1878 002 732 (45x50-18N)	365 366 368 369 370 371 372 373 374 375 376 377 378 379 380 381 383 384 385 386 387 388 389 390 391 392 393 394 412 413 414 415 416 419 420	MERCEDES-BENZ	1878 003 276 (1 3/4" -10N)	30 725 608 626 627	ENASA RENAULT TRUCKS
1878 002 734 (2" -10N)	732 733 734	EVOBUS	1878 003 277 (2" -10N)	30	ENASA
1878 002 735 (2" -10N)	510 514 515 516 517 518 530 534 535 547 551 552 553 554 559 561 562 563 564 565 566 572 573 585 586 587 588 592 593 784	MERCEDES-BENZ	1878 003 332 (1 3/4"-10N)	15 16 18	DAF
1878 002 825 (2"-10N)	739	IVECO	1878 003 339 (1 3/4" -10N)	648 649 826 827	SCANIA
1878 002 878 (2" -10N)	1 722 14 21 26 501 503 504 526 528 533 540 541 542 545 559 561 567 568 576 577 578 584 589 590	ASTRA BOVA DAF MERCEDES-BENZ	1878 003 365 (41x45-22N)	649 651	SCANIA
1878 002 955 (1 3/4" -10N)	68 78 79 80 81 82 83 104 108 109 110 111 112 113 114 115 116 117 740 128 129 130 131 132 133 834	IVECO MAGIRUS-DEUTZ VAN HOOL	1878 003 647 (2"-10N)	20 24 29	DAF
1878 003 065 (46x50-24N)	652 653	SCANIA	1878 003 657 (1 3/4" -10N)	723 724 724 727 729 730 731 732 733 734 132 743 744 745 303 304 305 306 307 309 310 311 312 313 314 315 316 317 318 319 320 321 322 751 753 754 755 756 759 760 776 777 778 779 786 788 796 798 801 802 803 804 805 806 807 808 809 810 811 812 813 667 832	DAF DRÖGMÖLLER EVOBUS MAGIRUS-DEUTZ MAN
1878 003 066 (46x50-24N)	651 652 827	SCANIA	1878 003 658 (46x50-24N)	651 828	MERCEDES-BENZ
1878 003 238 (41x45-22N)	648 649 651 826 827 828	SCANIA	1878 003 661 (1 3/4" -10N)	80 114 659 660 661 664 665	NEOPLAN
1878 003 242 (2" -10N)	674 715	VOLVO	1878 003 662 (2" -10N)	786 787 788 660	TAM SCANIA
1878 003 269 (1 3/4" -10N)	722 8 9 11 12 13 26 523 540 541 548 556 557 560 569 570	BOVA DAF MERCEDES-BENZ	1878 003 667 (2" -10N)	20 24 25 29 30	IVECO STEYR
			1878 003 662 (2" -10N)	786 787 788 660	MERCEDES-BENZ STEYR
			1878 003 767 (2" -10N)	20 24 25 29 30	DAF
			1878 003 768 (46x50-24N)	681 682 683 685 686 687 690 698 700 701 702 703 704 705 706 708 709 710 711 712	VOLVO
			1878 003 779 (1 3/4"- 10N)	839 840 841	VOLVO
			1878 003 780 (46x50-24N)	515 516 517 518 534 535 552 563 564 565 566 569 585 586 587 588 593	MERCEDES-BENZ

Artikelnummer Article No.	Seite Page	Hersteller Manufacturer	Artikelnummer Article No.	Seite Page	Hersteller Manufacturer
1878 006 129 (46x50-24N)	618 621 622 623 638 639 681 682 683 686 687 698 700 701 702 703 704 705 706 711 712 718 844 845	RENAULT TRUCKS VOLVO	1878 023 831 (36x40-18N)	396 397 399 401 403 404 406 407 409 410 411 412 413 414 415 416 418 419 420	MERCEDES-BENZ
1878 006 173 (36x40-18N)	791	MERCEDES-BENZ	1878 023 931 (36x40-18N)	394 396 397 399 401 403 404 407 410 412 415 416 418 419 420	MERCEDES-BENZ
1878 006 370 (46x50-24N)	653	SCANIA	1878 026 241 (1 3/4"-10N)	736 737 738 603 613 614 615 616 617 626 627 635 636 823 824 825 845	IRISBUS RENAULT TRUCKS
1878 006 584 (46x50-24N)	638	RENAULT TRUCKS	1878 026 431 (28x35-10N)	349 350	MERCEDES-BENZ
1878 006 637 (36x40-18N)	458	MERCEDES-BENZ	1878 027 231 (1 3/4"-10N)	722 19	BOVA DAF
1878 006 713 (1 3/4"-10N)	249 251 252	MAN	1878 027 442 (50x55-20N)	602 603 608 610 611 626 627 645 646	RENAULT TRUCKS
1878 006 854 (46x50-24N)	653	SCANIA	1878 032 032 (2"-10N)	736 738 69 70 71 72 73 74 84 86 88 91 93 94 95 97 98 823 826	IRISBUS IVECO
1878 007 046 (46x50-24N)	604 612 644 681 682 683 703 704 706	RENAULT TRUCKS VOLVO	1878 032 331 (2"-10N)	637 686	RENAULT TRUCKS RENAULT TRUCKS VOLVO
1878 007 126 (SAE 2)	256 287	MAN	1878 039 631 (1 3/4"-10N)	118 631 635	KAMAZ RENAULT TRUCKS
1878 007 169 (46x50-24N)	689 690	VOLVO	1878 040 334 (1 3/4"-10N)	839 840 841	VOLVO
1878 007 170 (46x50-24N)	604 612 644 681 682 683 703 704 706	RENAULT TRUCKS VOLVO	1878 043 231 (46x50-24N)	651 652 827 828	SCANIA
1878 007 172 (1 3/4")	16 17	DAF	1878 044 631 (1 1/2"-10N)	17 172 190 191 192 193 194 195 198 199 201 203 204 208 209 210 211 256 654 655 656 657 658	DAF MAN
1878 007 185 (45x50-18N)	354 360 364	MERCEDES-BENZ	1878 049 041 # (40x45-16N)	738 625 826	IRISBUS RENAULT TRUCKS
1878 007 250 (1 3/4"-10N)	50	IVECO	1878 051 801 (46x50-24N)	75 145 146 147 148 149 150 151 152 153 154 155 156 157 158 159 161 162 163 164 165 167 181 183 184 186 187 188 189	IVECO MAN
1878 007 253 (46x50-24N)	654	SCANIA			
1878 007 254 (46x50-24N)	654	SCANIA			
1878 019 001 (1 1/2"-10N)	1 2	AVIA			
1878 020 241 (50x55-20N)	735 736 737 602 603 604 605 606 608 609 614 615 616 617 618 619 620 621 623 624 625 626 627 628 636 637 639 640 641 823 824 825	IRISBUS RENAULT TRUCKS			
1878 021 731 (1 1/2"-10N)	698	VOLVO			
1878 022 841 (2"-10N)	737 110 116 133 602 603 604 605 606 608 609 610 614 615 618 619 623 624 625 626 627 628 636 637 639	IRISBUS IVECO MAGIRUS-DEUTZ RENAULT TRUCKS			

Arithmetische Liste / Part number list

Artikelnummer Article No.	Seite Page	Hersteller Manufacturer	Artikelnummer Article No.	Seite Page	Hersteller Manufacturer
1878 052 842 (36x40-18N)	394 396 397	MERCEDES-BENZ	1878 080 034 (2" -10N)	732 733 734	EVOBUS MAN
	399 401 403			134 136 137	
	404 407 410			139 141 142	
	430 431 454			159 164 166	
	455 456 457			168 169 172	
	464 465 468			175 176 177	
	469 472 477			178 179 180	
	486 493 772			181 182 183	
	793 794			184 185 186	
	187 188 189			187 188 189	
1878 054 933 (2"-10N)	19 20 21	DAF	208 317 746	MERCEDES-BENZ	
	22 23 25		747 748 749		
	26 27 28		757 761 762		
	29		763		
737	IRISBUS SISU	783 784 785	NEOPLAN		
654		792			
1878 054 951 (2"-10N)	72 75 76	IVECO	800 808 809		
1878 061 841 (1 3/4"-10N)	207 748	MAN VAN HOOL	811 812 813		
	835		817 819 820		
1878 062 944 (41x45-22N)	650 651	SCANIA	821 822		
1878 063 231 # (46x50-24N)	651 652 827	SCANIA	595 596 597	ÖSTERREICHISCHE AUTOMOBILFABRIK (ÖAF) STEYR	
	828		598 599 600		
1878 065 131 # (1 3/4"-10N)	731	EVOBUS MAN	659 660 661	BOVA DAF EVOBUS KAMAZ MAN	
	755				
1878 074 641 (28x35-10N)	347 348 349	MERCEDES-BENZ	1878 080 037 (2" -10N)	722 723	
1878 074 841 (1 1/2"-10N)	51 52 53	IVECO	723		
1878 076 031 (1 1/2"-10N)	681 692 838	VOLVO	726 732 733		
	842		118		
1878 079 306 (1 3/4"-10N)	50	IVECO MAZ	218 219 220		
	325		221 222 223		
1878 079 331 (1 1/2" 10N)	15	DAF IVECO MAN	224 225 226		
	53 59 65		227 228 238		
	191 192 193		239 246 257		
	196 197 198		258 259 260		
	210 213 247		264 265 266		
	248 249 250		267 268 269		
	251 252		270 275 276		
	325		278 279 281		
			282 286 288		
			289 290 292		
	294 295 297				
	298 746 757				
1878 080 031 (1 3/4"-10N)	725 730 731	EVOBUS LAZ MAN MAZ MERCEDES-BENZ	760 761 762	MERCEDES-BENZ	
	733 734		509 513 514		
	741		515 516 517		
	256 748 749		518 526 527		
	750 751 755		534 546 547		
	756 757 758		550 551 552		
	759 760 761		553 554 557		
	326 764		559 560 561		
	481 482 483		562 563 564		
	490 491 506		565 566 569		
507 520 522	570 571 572				
531 543 547	573 581 582				
548 549 777	583 585 586				
778 784 790	587 588 590				
1878 080 033 (2" -10N)	731 734	EVOBUS MAN MERCEDES-BENZ	591 592 593	NEOPLAN	
	746 751 754		772 776 779		
	757 758 760		782 783 784		
	761 762		785 789 790		
	491 492 493		792 796		
	511 512 513		799 800 816		
	531 532 542		817 818 819		
	547 548 549				

Artikelnummer Article No.	Seite Page	Hersteller Manufacturer	Artikelnummer Article No.	Seite Page	Hersteller Manufacturer
1878 085 641 (2"-10N)	118 748 749 757 798 799 800 815 816 836 721	KAMAZ MAN NEOPLAN VAN HOOL YaMZ	1878 600 827 (20x22,5-20N)	796 797	mitsubishi
1878 085 741 (2"-10N)	1 69 70 71 72 73 74 75 81 83 86 87 90 91 92 94 95 96 97 98 99 100 103 111 113 115 741 619 620	ASTRA IVECO RENAULT TRUCKS	1878 600 834 (1 1/4"-10N)	50 77 104 112 117 739	IVECO
1878 085 742 (1 3/4"-10N)	24 25 732 733 110 811 812 813	DAF EVOBUS IVECO NEOPLAN	1878 600 841 (1 3/8"-10N)	50 77 104 105 106 738 739 740 122	IVECO MAGIRUS-DEUTZ
1878 086 741 (1 3/4"-10N)	8 9 10 11 12 13 25 26 751 753 760 834 835	DAF MAN VAN HOOL	1878 634 014 (1 3/4"-10N)	502 522 525 532 544 602 645	MERCEDES-BENZ RENAULT TRUCKS MERCEDES-BENZ
1878 086 742 # (2"-10N)	835	VAN HOOL	1878 634 016 (1 3/4"-10N)	558	MERCEDES-BENZ
1878 086 941 (2"-10N)	135 136 137 138 140 141 142 143 145 146 147 148 149 150 151 152 153 155 156 158 159 160 161 162 163 164 165 166 167 168 169 170 171 208 306 307 312 313 314 317 318 319 320 321 322 323 324 325 803 804 598 599 600 601	MAN NEOPLAN ÖSTERREICHISCHE AUTOMOBILFABRIK (ÖAF)	1878 634 017 (36x45-10N)	111 112 114 127 129 130 131 132 133	IVECO MAGIRUS-DEUTZ
1878 087 141 (2"-10N)	545	MERCEDES-BENZ	1878 634 020 (2"-10N)	115 117	IVECO
1878 087 241 (2"-10N)	677	VOLVO	1878 634 022 # (2"-10N)	732 734 384 509 510 514 515 516 517 518 530 535 547 551 552 553 554 559 560 561 562 563 564 565 566 570 571 572 573 583 585 586 587 588 593 801 802 803 804 813 814	EVOBUS MERCEDES-BENZ
1878 600 501 (26,5x28,9-26N)	328 330 331 333 334 335 336 337 432 455 456 457 766 767 769 772 793	MERCEDES-BENZ	1878 634 023 # (2"-10N)	732 734 801 802 803 804 813 814	EVOBUS NEOPLAN
1878 600 557 (36,1x44,7-10N)	691	VOLVO	1878 634 026 (2"-10N)	676 683 684 685 686 697 707 708 709 710 711 718 840 841 842 843 844	VOLVO
1878 600 560 (36x40-18N)	430 431 454	MERCEDES-BENZ	1878 634 027 (2"-10N)	483 484 508 513 524 525 532 544 545 547 549 550 557 558 559 570 581 772	MERCEDES-BENZ
1878 600 563 (31x38,4-10N)	692 693	VOLVO	1878 634 029 (23x26-23N)	797	MITSUBISHI
			1878 634 034 (1 3/4"-10N)	736 737 738 635 638 680 697	IRISBUS RENAULT TRUCKS VOLVO
			1878 634 038 (1 3/4"-10N)	680 681	VOLVO
			1878 634 052 (23x27-10N)	339 340 341 342 343 344 345 346 458 462 781	MERCEDES-BENZ
			1878 859 001 (1 3/8"-10N)	668	VOLKSWAGEN
			1878 988 102 (26,5x28,9-26N)	670 671 672 837 838	VOLKSWAGEN
			1878 992 401 # (36x40-20N)	430 431 447 450 451 452	MERCEDES-BENZ



Arithmetische Liste / Part number list

Artikelnummer Article No.	Seite Page	Hersteller Manufacturer	Artikelnummer Article No.	Seite Page	Hersteller Manufacturer
1878 994 001 (26,5x28,7-26N)	327 328 330 332 334 336 765 766 769 670 671 837	MERCEDES-BENZ VOLKSWAGEN	1882 019 133	81 508 509 510 512 513 514 515 516 517 518 524 525 526 527 529 530 531 532 534 535 544 545 546 548 549 550 551 552 553 554 557 558 559 560 561 562 563 565 570 571 572 573 581 582 583 585 586 587 588 590 592 593	IVECO MERCEDES-BENZ
1878 997 101 (23x29-10N)	34 36 37 38 40 41 50 739	IVECO	1882 022 101	602 608 626 627 645	RENAULT TRUCKS
1880 071 008	30 118 119	DEMAG LIEBHERR	1882 110 513	662 663 664	STEYR
1880 083 132 #	83 119 120 121 199 299 667 832	IVECO LIEBHERR MAGIRUS-DEUTZ MAN TAM	1882 110 532 #	200 299 300 301 303 305 308 312 460 461 594 595 596 642	MAN MERCEDES-BENZ ÖSTERREICHISCHE AUTOMOBILFABRIK (ÖAF) RENAULT TRUCKS
1880 092 415 #	31 199 200 662	FAUN MAN STEYR	1882 110 542	3 4 5 6 14 723 724 200 461 489 491 494 497 498 518 519	DAF MAN MERCEDES-BENZ
1881 009 201 #	31	FAUN	1882 137 307 #	3 14 667	DAF TAM
1881 010 139 #	30 118 119 120 122	DEMAG LIEBHERR MAGIRUS-DEUTZ	1882 166 737	119 461 477 478 482 487 491 494 497 498 499 500 501 505 506 507 511 518 519 521 522 530 531 537 538 539 540 555 794 795	LIEBHERR MERCEDES-BENZ
1881 039 531 #	725 726 727 728 801 807 808 810 811 814 662 663	EVOBUS NEOPLAN STEYR	1882 201 132	340 346 469 470 473 475 476 479 484 485 488 510 774 775 795	MERCEDES-BENZ
1881 039 532 #	32 33 735 121 122 123 124 125 130 131 741 742 743 763 459 460 461 782 794 796 832	FAUN IKARUS MAGIRUS-DEUTZ MAN MERCEDES-BENZ TAM	1882 205 234	31 339 342 343 345 346 462 463 464 465 781 793	FAUN MERCEDES-BENZ
1881 041 656 #	725 726 727 728 31 32 33 742 743 460 461 781	EVOBUS FAUN MAGIRUS-DEUTZ MERCEDES-BENZ	1882 209 335 #	299 300 301 302 304 305 308 310 312	MAN
1881 059 208	30 340 343 459 460 461 462 781	DEMAG MERCEDES-BENZ			
1881 065 101	33	FAUN			
1881 089 002	31	FAUN			
1881 089 009 ▲	427	MERCEDES-BENZ			
1881 096 444 ▲	107 122 123 741	IVECO MAGIRUS-DEUTZ			
1882 017 131	135 136 137 138 140 141 142 143 145 146 147 148 149 150 151 152 153 155 156 158 159 160 161 162 163 164 165 166 167 168 169 170 171 208 306 307 312 313 314	MAN			

Artikelnummer Article No.	Seite Page	Hersteller Manufacturer	Artikelnummer Article No.	Seite Page	Hersteller Manufacturer	
1882 226 533	678 679 680	VOLVO	1882 301 239	723	BOVA DRÖGMÖLLER EVOBUS	
	713 714 715			724		
	717 718 839			727 728 729		
	840 841 842			730 731 732		
1882 229 131 #	423 424 425	MERCEDES-BENZ		734	111 112 114	IVECO
	426 427 428			115 116 117		
	434 436 439			129 130 131		
1882 230 238	460 487 488	MERCEDES-BENZ		132	132	MAGIRUS-DEUTZ
	782					
1882 231 131 #	423 428 431	MERCEDES-BENZ		303 304 305	303 304 305	MAN
	432 433 438					
1882 234 433	479 485 486	MERCEDES-BENZ		306 307 309	310 311 312	
	489 494 497			313 314 315		
	498 510 511			316 317 318		
	536 539 774		319 320 321			
	775 795		322 752 759			
1882 250 143	673 674 677	VOLVO	763 764		MERCEDES-BENZ	
	678 679 680		499 500 501			
	713 714 715		502 503 522			
	717 718 841		523 525 526			
	842 843		532 533 537			
1882 252 331	118	KÄSSBOHRER MERCEDES-BENZ	538 539 540			
	466 467 471		541 542 544			
	479 484 485		556 557 558			
	493 510 772		566 567 569			
	773 774 775	570 571 574	NEOPLAN			
	794 795	575 576 577				
	806 807 810	579 580 582				
	814	583 591 776				
1882 252 333	725	EVOBUS MERCEDES-BENZ	778 779 787			
	470 476 479		796			
	484 485 493		798 800 801			
	510		802 803 804			
1882 261 013 #	125	MAGIRUS-DEUTZ STEYR	806 807 808			
	663		809 810 811			
1882 280 112	307 310 311	MAN	812 813 815			
	313 314 316		822			
	317 318 319		832			ÖSTERREICHISCHE AUTOMOBILFABRIK (ÖAF) TAM
	321 322 323					
1882 280 140	674 675 715	VOLVO	1882 302 131	727 728 729	EVOBUS	
	716					
1882 280 213	119	LIEBHERR MAN		734		
	307 310 313			119		
	321 324	301 302 303				
	674 675 677	304 305 306				
	678 679 680	308 309 310				
1882 282 331	713 714 715	VOLVO		311 312 313		
	716			314 315 317		
	426 427 428			318 320 322		
	429 435 436			752 754 759		
	438			475 480 481		
1882 288 131	481 497 500	MERCEDES-BENZ		482 483 490		MERCEDES-BENZ
	505 506 518			491 492 497		
	519 521 535		498 499 501			
	537 538 539		505 506 518			
	555		519 520 521			
1882 301 238 #	481 482 483	MERCEDES-BENZ	522 531 536			
	490 491 492		537 538 539			
	499 520 521		540 555 556			
	536 537 538		777 778 780			
	555 556 777		796			
	778 780 796		801 802			NEOPLAN
	801					
			NEOPLAN			

Arithmetische Liste / Part number list

Artikelnummer Article No.	Seite Page	Hersteller Manufacturer	Artikelnummer Article No.	Seite Page	Hersteller Manufacturer
1882 302 132 #	505 506 518 519	MERCEDES-BENZ	1882 327 003 #	663 664 665	STEYR
1882 302 135 #	483 492 500 501 531 539 543	MERCEDES-BENZ	1882 330 032 #	9 735 127 129 130 131 132 301 303 306 309 312 315 318 751 754 763 538 779 780 595 596 598	DAF IKARUS MAGIRUS-DEUTZ MAN MERCEDES-BENZ ÖSTERREICHISCHE AUTOMOBILFABRIK (ÖAF) RENAULT TRUCKS VAN HOOL
1882 304 208	659	STEYR	1882 341 001	724 731 732 502 504 528 529 533 541 542 546 557 559 561 563 568 569 576 577 578 584 589 590	DRÖGMÖLLER EVOBUS MERCEDES-BENZ
1882 304 237	502 522 523 525 532 537 540 541 544 548 556 557 558 560 566 567 569 570 571 574 575 576 579 580 581 582 583	MERCEDES-BENZ	1882 342 134	728 729 730 731 307 310 311 313 314 316 317 318 319 321 322 323 324 325 751 753 755 756 759 760 501 503 504 526 528 533 540 541 542 545 559 561 567 568 576 577 578 584 589 590 776 779 786 787 788 798 801 802 804 805 808 809 810 811 812 813 664 665 832 834 835	EVOBUS MAN MERCEDES-BENZ NEOPLAN STEYR TAM VAN HOOL
1882 305 131	466 467 468 470 471 473 479 484 485 493 510 772 773 774 794 795	MERCEDES-BENZ	1882 342 135 #	731 753 755 760 834 835	EVOBUS MAN VAN HOOL
1882 305 132	473 476 479 484 485 493	MERCEDES-BENZ	1882 345 101	114	IVECO
1882 306 136 #	77 78 79 82 128 129	IVECO MAGIRUS-DEUTZ	1882 346 131 #	306 307 309 310 315 318 319 321 323 503 526 528 541 542 550 559 561 568 577 578 584 589 590	MAN MERCEDES-BENZ
1882 306 242	114 116 117 131 132	IVECO MAGIRUS-DEUTZ	1882 349 003	724 503 504 524	DRÖGMÖLLER MERCEDES-BENZ
1882 307 131	81 82 124 125	IVECO MAGIRUS-DEUTZ			
1882 311 131 #	776 806 807 810 815	MERCEDES-BENZ NEOPLAN			
1882 316 035 #	735 77 78 79 82 83 114 116 128 129 743 744 745	IKARUS IVECO MAGIRUS-DEUTZ			
1882 317 131	343 346 465 466 467 468 471 472 473 772 773 781	MERCEDES-BENZ			
1882 320 131	131	MAGIRUS-DEUTZ			
1882 325 134	725 726 727 728 734 109 113 114 115 740 741 121 125 126 127 128 131 742 743 744 200 301 304 601 602 655 665 667 832 673 677 679 714 717 842	EVOBUS IVECO MAGIRUS-DEUTZ MAN ÖSTERREICHISCHE AUTOMOBILFABRIK (ÖAF) STEYR TAM VOLVO			
1882 325 139	32 33 68 76 77 78 79 82 83 107 108	FAUN IVECO			

Artikelnummer Article No.	Seite Page	Hersteller Manufacturer	Artikelnummer Article No.	Seite Page	Hersteller Manufacturer
1882 806 001 ▲	50 104 105 738 739	IVECO	1888 067 042 # (310/41x45-22N)	426 427 428 429 435 437 440 441 442 444 449 450	MERCEDES-BENZ
1888 015 346	307 310 311 313 314 316 317 318 319 321 322 323	MAN	1888 600 101 # (225/45x50-24N)	432 433	MERCEDES-BENZ
1888 015 515 # (380/ 2"-10N)	674 675 715 716	VOLVO	1888 877 101 # (Ge 280/45x50-24N) (Mo 280/26x32-10N)	423 424 425 426 427 429 433 434 435 436 438 439	MERCEDES-BENZ
1888 015 523 #	119 321	LIEBHERR MAN	1888 877 102 # (280/45x50-24N)	424 425 426 427 428 429 433 434 435 436 438 439 440	MERCEDES-BENZ
1888 019 445 #	673 677 678 679 680 713 714 715 717 718 841 842 843	VOLVO	1888 877 103 # (280/45x50-24N)	427 428 429 433 435 436 438 439 440	MERCEDES-BENZ
1888 019 542 #	673 674 714 715	VOLVO	1888 893 001 # (225/45x50-24N)	423 432 433 434 435 437 441 442	MERCEDES-BENZ
1888 042 009	2 724 731 732 502 504 528 529 533 541 542 546 557 559 561 563 568 569 576 577 578 584 589 590 654	DAEWOO DRÖGMÖLLER EVOBUS MERCEDES-BENZ	1888 916 001 # (330/45x50-24N)	430 431	MERCEDES-BENZ
1888 055 041	724 503 504 526 527 533 541 560 574 575 576 579 580 582 583	DRÖGMÖLLER MERCEDES-BENZ	1888 998 201 # (310/45x50-24N)	428 429 430 437 440 444 447 448	MERCEDES-BENZ
1888 055 247	504 524 529 530 542 564 579 586 589 590 592 798 805	MERCEDES-BENZ	1888 998 901 ▲# (330/45x50-24N)	447 450 451 452 453	MERCEDES-BENZ
1888 063 137	81 508 509 510 512 513 514 515 516 517 518 524 525 526 527 529 530 531 532 534 535 541 544 545 546 548 549 550 551 552 553 554 557 558 559 560 561 562 563 565 567 570 571 572 573 576 581 582 583 585 586 587 588 590 592 593	NEOPLAN IVECO MERCEDES-BENZ	1888 998 902 # (330/45x50-24N)	443 444 445 446 447 448 449 450 451 452 453 454	MERCEDES-BENZ
1888 067 031 # (310/45x50-24N)	428 429 430 437 440 443 444 447 448	MERCEDES-BENZ	1897 375 775	602 611 629 631 634 641 642 645 646	RENAULT TRUCKS
			1897 376 506	607 609 610 611 625 634 635 645	RENAULT TRUCKS
			1898 917 116 ▲ (28,7x35,1-10N)	631 641	RENAULT TRUCKS
			2290 601 007	327 329 331 332 335 766 767	MERCEDES-BENZ
			2290 601 011  	328 329 330 332 335 336 338 339 765 767 769	MERCEDES-BENZ
			2290 601 018 	331 333 334 337 338 768	MERCEDES-BENZ
			2294 000 525	328 330 331 333 335 337 455 456 457 766 767 772 793	MERCEDES-BENZ
			2294 000 767	327 329 331 332 335 336 766 767	MERCEDES-BENZ
			2294 000 834	350 351 352 353 770 771	MERCEDES-BENZ
			2294 000 835	331 333 334 337 338 768	MERCEDES-BENZ
			2294 000 994	331 333 334 337 338 350	MERCEDES-BENZ

Arithmetische Liste / Part number list

Artikelnummer Article No.	Seite Page	Hersteller Manufacturer	Artikelnummer Article No.	Seite Page	Hersteller Manufacturer
2294 001 744	351	MERCEDES-BENZ	3000 951 824	331 333 334	MERCEDES-BENZ
3000 055 005	735	IKARUS	(26x29-26N)	337 338 768	
	669 670 673	VOLKSWAGEN	3000 951 841	668 836	VOLKSWAGEN
	836 837		(26,59x28,92-26N)		
3000 055 006	668 669 672	VOLKSWAGEN	3000 951 876	668 836	VOLKSWAGEN
	673 836		3000 951 932	668 836	VOLKSWAGEN
3000 199 001	797	MITSUBISHI	(26,5x28,7-26N)		
3000 205 001	796 797	MITSUBISHI	3000 990 144	331 333 334	MERCEDES-BENZ
3000 263 001	797	MITSUBISHI	(26x29-26N)	337 338 768	
3000 264 001	797	MITSUBISHI	3000 990 195	331 333 334	MERCEDES-BENZ
3000 297 002	347 348	MERCEDES-BENZ		337 338 768	
3000 325 001 #	2 722	BARKAS	3000 990 204	668 836	VOLKSWAGEN
3000 424 002	326 327 764	MERCEDES-BENZ	3000 990 217	668 836	VOLKSWAGEN
3000 434 001	34 35 38	IVECO	3000 990 218	327 328 329	MERCEDES-BENZ
	39		(26,5x29-26N)	330 332 334	
3000 486 001	797	MITSUBISHI		335 336 338	
3000 725 001	328 330 331	MERCEDES-BENZ		339 765 766	
	333 335 337		3000 990 246	668 836	VOLKSWAGEN
	455 456 457		3000 990 252	327 328 329	MERCEDES-BENZ
	766 767 772		(26,5x29-26N)	330 332 334	
	793			335 336 338	
3000 726 001	329 335 351	MERCEDES-BENZ		339 765 766	
	766 767			767 769	
3000 826 901	327 328 330	MERCEDES-BENZ	3000 990 287	331 333 334	MERCEDES-BENZ
	332 334 336			337 338 350	
	765 766 769			352 353 768	
	670 671 837	VOLKSWAGEN		770 771	
3000 828 601	670 672 837	VOLKSWAGEN	3074 003 343	668 669 670	VOLKSWAGEN
3000 840 101	14	DAF		672 673 836	
3000 845 001	671 672 838	VOLKSWAGEN		837	
3000 845 101	670 671 672	VOLKSWAGEN	3074 600 205	326 327 764	MERCEDES-BENZ
	837		3082 007 333	665	STEYR
3000 845 801	670 671 837	VOLKSWAGEN	3082 078 032	458	MERCEDES-BENZ
3000 846 501	351 352	MERCEDES-BENZ	3082 086 434	669 670	VOLKSWAGEN
3000 950 701	14	DAF	3082 121 031	339 340 341	MERCEDES-BENZ
3000 951 026	34 35 36	IVECO		342 343 344	
	37 38 39			345 346 347	
	40 41 42			348 458 459	
	43 44 738			460 462 781	
	739		3082 156 031	814	NEOPLAN
3000 951 104	670 671 672	VOLKSWAGEN	3082 157 031	428	MERCEDES-BENZ
	837 838		3082 190 031	735	IKARUS
3000 951 107	671 672 838	VOLKSWAGEN		668 669 670	VOLKSWAGEN
(26,5x28,9-26N)				672 673 836	
3000 951 111	350 352 353	MERCEDES-BENZ		837	
(26,56x28,9-26N)	770 771		3082 191 032	326 327 764	MERCEDES-BENZ
3000 951 112	350 351 353	MERCEDES-BENZ	3082 267 233	327 329 331	MERCEDES-BENZ
(26,6x28,9-26N)	771			332 335 351	
3000 951 188	331 333 334	MERCEDES-BENZ		352 766 767	
(26x29-26N)	337 338 768		3082 268 031	327 328 330	MERCEDES-BENZ
3000 951 205	352	MERCEDES-BENZ		332 334 336	
3000 951 373	594	NISSAN		351 352 765	
(23,1x28,7-10N)				766 769	
3000 951 422	797	MITSUBISHI		670 671 837	VOLKSWAGEN
3000 951 710	671 672 838	VOLKSWAGEN	3082 269 031	328 330 331	MERCEDES-BENZ
3000 951 784	351	MERCEDES-BENZ		333 334 335	
(26,5x28,7-26N)				336 337 427	
3000 951 785	328 330 331	MERCEDES-BENZ		428 432 455	
	333 334 335			456 457 766	
	336 337 432			767 769 772	
	455 456 457			793	
	766 767 769		3082 308 043	670 671 672	VOLKSWAGEN
	772 793				

Artikelnummer Article No.	Seite Page	Hersteller Manufacturer	Artikelnummer Article No.	Seite Page	Hersteller Manufacturer
3082 600 509	671 672 838	VOLKSWAGEN	3151 000 079	325	MAZ
3082 600 522	670 671 672 837 838	VOLKSWAGEN		823	PAZ
3082 639 402	670 671 837	VOLKSWAGEN	3151 000 144	1	ASTRA
3082 737 001	14	DAF		28 29	DAF
3082 833 001	796 797	DAF		736	IRISBUS
3082 881 001	797	DAF		61 63 65	IVECO
3082 919 001	671 672 838	DAF		66 67 68	
3082 931 001	797	DAF		69 70 71	
3082 936 001	797	DAF		72 73 74	
3082 956 001	13 14	DAF		75 76 83	
3082 967 001	2 722	DAF		84 85 86	
3082 973 001	14	DAF		87 88 90	
3083 039 031	34 35 36 37 38 39 40 41 42 43 44 738 739	IVECO		91 92 93	
3100 000 003	563	IVECO		94 95 96	
3100 000 081	646 647	IVECO		97 98 99	
3100 002 038	81 101 102 103 112 113 116 133	IVECO		100 101 103	
3100 002 040	101 102 103 104 110 111 112 113 114 116 133	IVECO		111 113 115	
3100 002 549	839	IVECO		739 741	
3100 005 202	653	IVECO		215 216 217	MAN
3100 008 106	737 738 602 603 604 605 606 608 609 610 618 619 621 623 624 625 626 627 628 639 640 641 645 646 824 825 826	IVECO		218 219 220	
3100 008 201	827 828	IVECO		221 222 223	
3100 008 204	603 604 605 606 619 623 624 625 626 627 628 645	IVECO		224 225 226	
3100 023 031	34	IVECO		227 228 229	
3100 026 431	840 844	IVECO		230 231 232	
3100 026 432	676 677 844	IVECO		233 234 235	
3100 026 434	700 702 844	IVECO		236 237 238	
3130 010 100	427	IVECO		239 240 241	
3151 000 020	349 350	IVECO		242 243 244	
3151 000 034	722 19 20 21 22 23 24 26 27 28 29 117 118 133 134 135 136 137 138 139 140 141 142 143 144	IVECO		245 246 247	
		IVECO		249 251 252	
		IVECO		253 254 255	
		IVECO		256 257 258	
		IVECO		259 260 261	
		IVECO		262 263 264	
		IVECO		265 266 267	
		IVECO		268 269 270	
		IVECO		271 272 273	
		IVECO		274 275 276	
		IVECO		277 278 279	
		IVECO		280 281 282	
		IVECO		283 284 285	
		IVECO		286 287 288	
		IVECO		289 290 291	
		IVECO		292 293 294	
		IVECO		295 296 297	
		IVECO		298 299 746	
		IVECO		747 748 749	
		IVECO		799 800 813	NEOPLAN
		IVECO		815 816 817	
		IVECO		818 819 820	
		IVECO		821 822	
		IVECO		623 636 637	RENAULT TRUCKS
		IVECO		823	
		IVECO		830 831	SETRA
		IVECO		660 666 667	STEYR
		IVECO	3151 000 148	101 102 103	IVECO
		IVECO		104 110 111	
		IVECO		112 113 114	
		IVECO		116	
		IVECO		133	MAGIRUS-DEUTZ
		IVECO	3151 000 151	652 653 654	SCANIA
		IVECO		827	
		IVECO	3151 000 154	676 677 840	VOLVO

Arithmetische Liste / Part number list

Artikelnummer Article No.	Seite Page	Hersteller Manufacturer	Artikelnummer Article No.	Seite Page	Hersteller Manufacturer			
3151 000 157	722	BOVA	3151 000 374	465 468 469	MERCEDES-BENZ			
	725 732 733	EVOBUS		472 477 478				
	734			482 485 486				
	736 738	IRISBUS		487 488 489				
	118	KAMAZ		490 493 494				
	741	LAZ		496 497 498				
	749	MAN		505 506 507				
	326 764	MAZ		511 530 531				
	783 784 785	MERCEDES-BENZ		536 543 793				
	790			794 795				
	798 799 800	NEOPLAN	3151 000 375	723	BOVA			
	801 802 803			724		DRÖGMÖLLER		
	804 805 807			119			LIEBHERR	
	808 809 810			475 481 482				MERCEDES-BENZ
	811 812 813			483 490 491				
	814 815 816			492 497 498				
	823 826	RENAULT TRUCKS		499 500 501				
833	TEMSA	502 505 506						
		518 519 520						
		521 522 523						
3151 000 163	700 702 844	VOLVO	525 531 532					
3151 000 206	339 340 341	MERCEDES-BENZ	533 536 537					
	342 343 344		538 539 540					
	345 346 347		542 543 544					
	348 462 781		555 556 557					
3151 000 218	839	VOLVO	558 566 567					
3151 000 272	827 828	SCANIA	569 570 571					
3151 000 273	653 654	SCANIA	574 575 576					
3151 000 278	730 731	EVOBUS MERCEDES-BENZ	577 579 580					
	483 484 491		582 583 591					
	492 493 508		776 777 778					
	509 510 511		779 780 786					
	512 513 514		787					
	515 516 517		802 803 804	NEOPLAN				
	518 524 525		806 807 808					
	526 527 530		809 810 811					
	531 532 534		812 813 814					
	535 542 544		832	TAM				
	545 546 547		3151 000 392	MERCEDES-BENZ				
	548 549 550				521 522 555			
	551 552 553				3151 000 395	BOVA		
	554 557 558						723	DAF
	559 560 561						4 5 6	
	562 563 564						7 8 9	
	565 566 569						10 11 12	
	570 571 572						13 15 16	
	573 581 582						17 18 19	
	583 585 586						20 21 24	
	587 588 590		25 26					
	591 592 593		725 726 727	EVOBUS				
	783 789 790		728 734					
796	31 32 33	FAUN						
836	76 82 107		IVECO					
3151 000 285	602 606 607			RENAULT TRUCKS	113 114 115			
	609 610 625				741			
	629 630 631	119						
	633 644 825	121 123 126						
3151 000 335	723	DAF MAN MERCEDES-BENZ NEOPLAN SETRA	127 128 130	KING LONG LIEBHERR MAGIRUS-DEUTZ				
	760 761 762		131 743					
	783 784 789		200 201 202					
	790 791 792		203 204 205					
	799 817 818		206 207 208					
	819		299 300 301					
	828 829 830		302 303 304					
	831 832		305 306 307					

Artikelnummer Article No.	Seite Page	Hersteller Manufacturer	Artikelnummer Article No.	Seite Page	Hersteller Manufacturer	
3151 000 396	394 399 401	MERCEDES-BENZ	3151 000 497	772	MERCEDES-BENZ	
	403 404 406		3151 000 512	247 248 249		MAN
	407 409 410			250 251 252		
	411 412 413		253 256 751	752 753 754		STEYR
	414 415 419		755			
	420 431 455		659 660 661			
	456 457 772		664 665			
	789 791 793					
3151 000 397	15 16 17	DAF	3151 000 515	1	ASTRA	
3151 000 404	614 615 616	RENAULT TRUCKS		723	BOVA	
	617 619 620		6 8 9	DAF		
	636 637		11 12 13			
3151 000 419	738	IVECO		14 21 723	EVOBUS	
	117		KAMAZ	724		IKARUS
	325 326		MAZ	728		
	806		NEOPLAN	735		IVECO
	832 833		TAM	50 53 59		
	721		YaMZ	65 68 77		
3151 000 493	20 24 25	DAF		78 79 80	MAGIRUS-DEUTZ	
	28 29 30		81 82 83			
	736 737		107 108 109			
	84 85 86		110 111 112			
	87 88 89		114 115 116			
	90 91 92		117			
	93 94 95		123 124 125			
	96 97 98		126 127 128			
	99 100 101		129 130 131			
	118		132 133 743			
	215 216 217	744 745	SCANIA			
	218 219 220	827		VAN HOOL		
	221 222 223	833 834				
	224 225 226	3151 000 529		491 498 499	MERCEDES-BENZ	
	227 228 229	500 519 521				
	230 231 232	530 531 537				
	233 234 235	538 539 555				
	236 237 238	772 781				
	239 240 241	3151 000 547		733	EVOBUS	
	242 243 244	384 509 510		MERCEDES-BENZ		
	245 246 247	516 517 518				
	249 251 252	530 535 547				
	253 254 255	551 552 553				
	256 257 258	554 559 560				
	259 260 261	561 562 563				
	262 263 264	564 565 566				
	265 266 267	570 571 572				
	268 269 270	573 583 585				
	271 272 273	586 587 588				
	274 275 276	593 776 778				
	277 278 279	779 782 783				
	280 281 282	784 785 789				
283 284 285	790 796					
286 287 288	3151 000 549	481 482 483	MERCEDES-BENZ			
289 290 291	484 490 491					
292 293 294	492 493 501					
295 296 297	506 507 508					
298 299 746	509 512 520					
749	521 522 524					
799 800 815	525 526 529	NEOPLAN				
816 817 818	531 532 543					
819 820 821	544 545 546					
822	547 548 549					
830 831	552 557 558					
	561 564 565					
			SETRA			
				STEYR		

Arithmetische Liste / Part number list

Artikelnummer Article No.	Seite Page	Hersteller Manufacturer	Artikelnummer Article No.	Seite Page	Hersteller Manufacturer
3151 000 615	726 731 732 733 734	EVOBUS	3151 045 001	30 31 119 122	DEMAG FAUN LIEBHERR MAGIRUS-DEUTZ
3151 000 651	15 16 17 18 24 84 85 94	DAF IVECO	3151 051 031	437 440 441 442 443 444 445 446 447 448 449 450 451 452 453	MERCEDES-BENZ
3151 000 750	34	HINO	3151 054 031	108 109 112	IVECO
3151 000 752	635 638 680 697	RENAULT TRUCKS VOLVO	3151 065 031	34 35 36 37 38 39 40 41 738	IVECO
3151 000 809	680 681	VOLVO	3151 066 004	2 654	DAEWOO SCANIA
3151 000 958	117 118 299 300 301 302 303 304 305 308 310 312 325 326 468 642	KAMAZ MAN MAZ MERCEDES-BENZ RENAULT TRUCKS	3151 067 032	306 307 309 310 311 312 313 314 315 316 317 318 319 320 321 322 323 324 325	MAN
3151 001 035	623 638 639	RENAULT TRUCKS	3151 068 101	325 806	MAZ NEOPLAN
3151 001 082	791 792	MERCEDES-BENZ	3151 069 032	428	MERCEDES-BENZ
3151 001 083	354 360 364	MERCEDES-BENZ	3151 069 131	814	NEOPLAN
3151 001 084	737	IRISBUS	3151 071 032	108 128 129	IVECO MAGIRUS-DEUTZ
3151 011 001	665	STEYR	3151 079 031	481 482 490 499 505 506 520 536 537 538 539	MERCEDES-BENZ
3151 021 001	427 431	MERCEDES-BENZ	3151 082 001	659 664 665	STEYR
3151 027 102	727 728 729 730 731 732 733 734 654	EVOBUS SISU	3151 090 131	795	MERCEDES-BENZ
3151 027 133	728 730 731	EVOBUS	3151 094 041	479 486 494 497 498 510 511 536 774 775 795	MERCEDES-BENZ
3151 032 341	167	MAN	3151 095 043	339 340 342 343 345 346 460 462 463 464 465 466 467 469 470 471 473 475 476 479 484 485 488 493 510 772 773 774 781 793 794 795	MERCEDES-BENZ
3151 033 031	339 342 343 345 346 462 463 464 465 466 467 468 471 472 473 474 475 476 478 480 487 488 495 496 772 773 781 793	MERCEDES-BENZ	3151 098 031	740 128 129	IVECO MAGIRUS-DEUTZ
3151 034 031 ▲	339 340 341 342 343 344 345 346 458 459 460 462 781	MERCEDES-BENZ	3151 099 101	728 729	EVOBUS
3151 043 031	475 480 481 489 497 498 535 776	MERCEDES-BENZ	3151 105 141	674 678 679 680 713 714 715 717 718 842	VOLVO
3151 044 031	339 342 343 345 346 462 463 464 465 466 467 468 469 471 472 473 474 475 476 477 478 479 480 485 486 487 488 489 490 493 495 496 510 539 772 773 781 784 793 794 799 814	MERCEDES-BENZ NEOPLAN	3151 106 041	673 674 675 677 678 679 680 713 714 715 716 717	VOLVO
			3151 108 031	724 731 732 502 503 504	DRÖGMÖLLER EVOBUS MERCEDES-BENZ

Artikelnummer Article No.	Seite Page	Hersteller Manufacturer	Artikelnummer Article No.	Seite Page	Hersteller Manufacturer
3151 110 031	501 503 504	MERCEDES-BENZ	3151 186 001	798 805	NEOPLAN
	526 528 533		3151 193 041	735	IKARUS
	540 541 542		668 669 670	VOLKSWAGEN	
	545 559 561		672 673 836		
	567 568 576		837		
	577 578 584		3151 196 031	76 77 80	IVECO
589 590	83 107				
3151 111 032	7	DAF	3151 198 031	326 327 764	MERCEDES-BENZ
	125	MAGIRUS-DEUTZ	3151 199 001	1	AVIA
	663	STEYR		2 3 4	DAF
3151 114 031	76 79 104	IVECO	17		
	108 109 110		68 76 77	IVECO	
	111 112 113		81 106 107		
	740		740		
3151 116 031	485 488 495	MERCEDES-BENZ	122 123 124		MAGIRUS-DEUTZ
3151 117 031	115 117	IVECO	125 126 742		
3151 119 001	798 801	NEOPLAN	743 744		
3151 123 031	81 101 102	IVECO	190 197 198		MAN
	103 112 113		199 201 202		
	116		203 204 205		
	133		206 207 299		
3151 126 031	481 482 483	MERCEDES-BENZ	300 301 302		
	490 491 492		305 308 745		
	500 501 537		750 752 757		
	539 543 776		758		
	777 778 779		806	NEOPLAN	
	786 787 788		611 629 632	RENAULT TRUCKS	
	796		646		
	832		655 656	STEYR	
3151 127 031	76 108 109	IVECO	3151 202 001	325 326	MAZ
	110 111 112		3151 202 002	803 804 806	NEOPLAN
	113 740		3151 204 001	137 138 140	MAN
	128 129 130			141 142 143	
	132 133			146 147 148	
3151 145 101	30	ENASA	149 150 151		
3151 156 003	655 656 657	STEYR	152 153 155		
	658 659		156 158 160		
3151 166 031	507 508 509	MERCEDES-BENZ	162 164 165		
	510 512 513		166 167 168		
	514 515 516		170 171 208		
	517 518 521		212 313 323		
	524 525 526		500 523 527	MERCEDES-BENZ	
	527 529 530		528 540 541		
	531 532 534		542 548 550		
	535 543 544		556 557 560		
	545 546 548		561 566 567		
	549 550 551		568 569 570		
	552 553 554		571 574 575		
	557 558 559		576 577 578		
	560 561 562		579 580 581		
	563 565 570		582 583 584		
	571 572 573		589 590 591		
	581 582 583		608 626 627	RENAULT TRUCKS	
	585 586 587		3151 205 202	653	SCANIA
	588 590 592		3151 207 031	104 740 741	IVECO
	593		3151 208 001	1	ASTRA
	3151 170 131		735	IKARUS	119
347 348 349		3151 217 001	723		BOVA
464 769 770			659 660 661		STEYR
3151 182 031	545	MERCEDES-BENZ	3151 234 132	737	IRISBUS
3151 182 233	722	BOVA DAF	603 610 625		RENAULT TRUCKS
	8 9 11		824 825 826		
	12 13 21		3151 234 231	645	RENAULT TRUCKS

Arithmetische Liste / Part number list

Artikelnummer Article No.	Seite Page	Hersteller Manufacturer	Artikelnummer Article No.	Seite Page	Hersteller Manufacturer				
3151 248 031	327 328 329	MERCEDES-BENZ	3151 270 341	607 609 611	RENAULT TRUCKS				
	330 331 332			625 629 630					
	333 334 335			632 633 634					
	336 337 351			635 646 823					
	352 432 455			3151 270 602	458	MERCEDES-BENZ			
	456 457 765			3151 273 601	723	BOVA			
	766 767 769		VOLKSWAGEN	3151 274 131	613 614 615	RENAULT TRUCKS			
	772 793				616 617 618				
	670 671 672				620 621 622				
	837 838				623 636 637				
3151 249 001	834 835	VAN HOOL	3151 278 941	613 614 615	RENAULT TRUCKS				
3151 250 231	735 736 737	IRISBUS	3151 600 525	616 617	MITSUBISHI				
	738			797					
	613 614 615	RENAULT TRUCKS	3151 600 529	34 35 36	IVECO				
	616 617 618			37 38 39					
	619 620 621			40 41 42					
	631 635 636			43 44 45					
	637 823 824			46 47 49					
825	50 738 739								
3151 253 031	172 191 207	MAN	3151 600 533	673 677 679	VOLVO				
	208 209 210			681 692 693					
	211 212 213			714 717 718					
	214 236 249			838 841 842					
	253 254 255			843					
256	STEYR	3151 600 534	681 692 693	VOLVO					
656 657 658			838 839 840						
660			841 842						
3151 262 031	173 178 182	MAN	3151 600 535	681 692 838	VOLVO				
	184 185 187			842					
	188 189 217		3151 600 540	104 105 106	IVECO				
	218 219 235			107 739					
	237 238 239		3151 600 541	189 190 745	MAN				
	240 241 242			746					
	243 244 245		3151 600 544	51 52 53	IVECO				
	246 247 257			55 56 57					
	258 259 260			58 59 60					
	261 262 263			61 62 63					
	264 265 266			64 65 66					
	267 268 269			67 68					
	270 271 272			631 632 633		RENAULT TRUCKS			
	273 274 275			634 635					
	276 277 278			3151 600 548		14	DAF		
	279 280 281					106 107			
	282 283 284		3151 824 001	106 107	IVECO				
	285 286 287			673 677 679					
	288 289 290		3151 824 005	693 714 717	VOLVO				
	291 292 293			839					
	294 295 296			796 797		MITSUBISHI			
	297 298 299		797	797	MITSUBISHI				
	613 614 615		RENAULT TRUCKS	602 628	RENAULT TRUCKS				
	616 617 618			647					
	619 620 621			668					
	622 623 636			2 722		BARKAS			
	637 638 639			5 7		DAF			
	659 662 666			4		DAF			
	667			737		IRISBUS			
	3151 263 031			19 21 22		DAF	3180 000 009	603 610 625	RENAULT TRUCKS
				25 26				645 824 825	
				118				826	
144 145 168		827 828	SCANIA						
172 174 175		700 702 840							
176 177 178		844	VOLVO						
179 180 181									

Artikelnummer Article No.	Seite Page	Hersteller Manufacturer	Artikelnummer Article No.	Seite Page	Hersteller Manufacturer	
3180 001 008	34	HINO	3182 998 501	191 192 193	MAN	
	81 101 102	IVECO		196 197 198		
	103 104 110			212		
	111 112 113			394 396 397	MERCEDES-BENZ	
	114 116			399 401 403		
	133	MAGIRUS-DEUTZ		404 406 407		
	653	SCANIA		409 410 411		
	676 677 839	VOLVO		412 413 414		
	844			415 416 417		
				418 419 420		
3180 007 000	652 827	SCANIA	458			
3182 002 131	428 429 430	MERCEDES-BENZ	698		VOLVO	
	437 440 443					
	444 445 446		3400 030 033 #⊕	676 717 719	VOLVO	
	447 448 449		3400 031 033 ⊕	674 676 694	VOLVO	
	450 451 452			695 696 716		
	453 454			717 718 841		
3182 002 132	427	MERCEDES-BENZ	3400 032 033 #⊕	695 696	VOLVO	
3182 003 131	429 430 440	MERCEDES-BENZ	3400 035 032 #⊕	681 694	VOLVO	
	443 444 445		3400 037 031	681 692 693	VOLVO	
	446 447 448			838 842		
	449 450 451		3400 037 032	673 693 714	VOLVO	
	452 453 454			839		
3182 005 231	172 190 191	MAN	3400 040 032 ⊕	674 681 694	VOLVO	
	192 193 194			695 696 716		
	195 198 199			841		
	201 202 203					
	204 208 209					
	210 211 256	STEYR	3400 042 031 ⊖	79 80 81	IVECO	
	654 655 656			83 108 109		
	657 658			110 111 112		
				113 114 116		
				117 740		
3182 009 938	652 827	SCANIA	133		MAGIRUS-DEUTZ	
3182 600 101	394 396 397	MERCEDES-BENZ	3400 043 032 ⊕	676 683 684	VOLVO	
	399 401 403			685 686 697		
	404 406 407			708 709 710		
	409 410 411			711 718 840		
	412 413 414		3400 066 031	51 52 53		IVECO
	415 416 418			68		
	419 420 430		3400 068 031	57 59 61		IVECO
	431 454 455			63 64 65		
				66 67 68		
	3182 600 141		394 396 397	MERCEDES-BENZ		3400 074 031
399 401 403			66 67 68			
404 407 410			70 72			
416 458						
3182 600 142	247 248 249	MAN	3400 077 071	69 71 72	IVECO	
	250 251 252			73		
3182 600 166	396 397 399	MERCEDES-BENZ	3400 084 031	69 70 71	IVECO	
	401 403 404			72 73 74		
	407 410 416			84 86 88		
	458			91 93 94		
				95 97 98		
3182 600 172	396 397 416	MERCEDES-BENZ				
3182 997 801	351	MERCEDES-BENZ	3400 093 031 ⊕	605 606 619	RENAULT TRUCKS	
3182 997 802	327 328 329	MERCEDES-BENZ		621 624 628		
	330 332 334		3400 106 031 ⊕	674 695 696	VOLVO	
	335 336 765			716 718 841		
	766 767 769		3400 107 031	70 72 73	IVECO	
	668 836			74 84 93		
			VOLKSWAGEN	95		
3182 997 803	350 351 352	MERCEDES-BENZ	3400 116 001	692	VOLVO	
	353 770 771					
3182 997 804 [Ⓜ]	327 328 329	MERCEDES-BENZ	3400 116 101 #	681 692 693	VOLVO	
	330 331 332		3400 116 201 #	681 692 838		
	333 334 335			842		
	336 337 338		3400 116 301	677	VOLVO	
	339 350 351					
			3400 116 401 ⊖	650	SCANIA	

Arithmetische Liste / Part number list

Artikelnummer Article No.	Seite Page	Hersteller Manufacturer	Artikelnummer Article No.	Seite Page	Hersteller Manufacturer
3400 116 501	675 717	VOLVO	3400 121 501 ⊕	365 366 367	MERCEDES-BENZ
3400 116 601	602 603 604 605 606 608 609 623 624 625 627 639 640 641 824	RENAULT TRUCKS	(45x50-18N)	368 369 370 371 372 373 374 375 376 378 379 380 381 382 383 384 385 386 387 388 389 390 391 392 393 394 419 420 421	
3400 116 701	603 626 627 824	RENAULT TRUCKS	3400 121 601	384 509 510 516 517 518 530 535 547 551 552 553 554 559 560 561 562 563 564 565 566 570 571 572 573 583 585 586 587 588 593	MERCEDES-BENZ
3400 116 801	602 603 608 626 627 645 646	RENAULT TRUCKS			
3400 116 901	738 603 824 825	IRISBUS RENAULT TRUCKS			
3400 117 001	605 606 618 621 624 625 641	RENAULT TRUCKS			
3400 117 101	603 619 623 624	RENAULT TRUCKS			
3400 117 201	603 604 605 606 625 626 627 628	RENAULT TRUCKS			
3400 117 202	603 604 605 606 625 626 627 628 824 825	RENAULT TRUCKS	3400 121 701	172 191 207 208 209 210 211 212 213 214 236 249 253 254 255 256 656 657 658 660	MAN
3400 117 301 #	611 629 632 646	RENAULT TRUCKS			
3400 117 532	614 615 616 617 619 620 621 636 637	RENAULT TRUCKS			STEYR
3400 117 631 ▲	621	RENAULT TRUCKS	3400 121 801 ●	172 190 191 192 193 194 195 198 199 201 203 204 208 209 210 211 654 655 656 657 658	MAN
3400 117 701	34 36 37 38 40 41 50 739	IVECO			
3400 117 801	1 69 70 71 72 73 74 75 86 87 90 91 92 94 95 96 97 98 99 100 103 111 113 115	ASTRA IVECO	3400 121 901	135 137 138 139 140 141 142 143 144 145 146 147 148 149 150 151 152 153 154 155 156 157 158 163 164 167 168 600	MAN
3400 118 901 ●	80 114	IVECO			
3400 119 001 ●	108 109 112 114 116 739 740	IVECO			
3400 121 001	22 26 27	DAF			ÖSTERREICHISCHE AUTOMOBILFABRIK (ÖAF)
3400 121 101	722 21 26	BOVA DAF	3400 122 001 ●	652 827	SCANIA
3400 121 201 ●	394 396 397 399 401 403 404 407 410 412 415 416 418 419 420	MERCEDES-BENZ	3400 122 101	19 20 21 22 23 26 27 28 29	DAF
3400 121 301 ●	396 397 399 401 403 404 406 407 409 410 411 412 413 414 415 416 418 419 420	MERCEDES-BENZ	3400 122 201	134 135 136 137 138 139 140 141 142 143 144 145 146 149 150 152 153 154 155 156 157 158 159 160 161 162 163	MAN
3400 121 401	465 468 469	MERCEDES-BENZ			

Artikelnummer Article No.	Seite Page	Hersteller Manufacturer	Artikelnummer Article No.	Seite Page	Hersteller Manufacturer	
3400 122 301	134 136 137	MAN	3400 123 001	481 482 483	MERCEDES-BENZ	
	139 141 142			490 491 506		
	159 164 166			507 520 522		
	168 169 172			531 543 547		
	175 176 177			548 549 777		
	178 179 180		778 784			
	181 182 183		3400 123 101 #	603 619 623	RENAULT TRUCKS	
	184 185 186		624			
	187 188 189		3400 123 201 ▲	604 605 606	RENAULT TRUCKS	
	208 317 746		608 609 618			
	747 748 749		623 624 625			
	761 762 763		626 627 640			
	595 596 597		641			
	598 599 600		3400 123 301 ▲	619 623 624	RENAULT TRUCKS	
	659 660 661		3400 123 401	736 737	IRISBUS	
3400 122 401	468 472 476	MERCEDES-BENZ	3400 123 501 ⊕	651 828	SCANIA	
	479 485 486	NEOPLAN		3400 123 601 ⊕	651 828	SCANIA
	488 493 495			3400 123 701 ⊕	651 827	SCANIA
	510 773 784			3400 123 801 ⊕	651	SCANIA
	793 794			3400 123 901 ⊕	650 651	SCANIA
799	3400 124 001		483 484 508	MERCEDES-BENZ		
3400 122 501	508 524 525	MERCEDES-BENZ	3400 124 101	482 483 484	MERCEDES-BENZ	
	544 557 558	NEOPLAN		492 493 501		
				507 508 509		
3400 122 601	509 513 514		MERCEDES-BENZ	521 524 525		
	515 516 517	MERCEDES-BENZ	529 532 543			
	518 526 527		544 545 546			
	534 546 547		548 549 552			
	550 551 552		557 558 561			
	553 554 557		564 565 569			
	559 560 561		580 581 583			
	562 563 564		585 587 588			
	565 566 569		591 592 593			
	570 571 572		779 782 784			
	573 581 582		785 796			
	583 585 586		3400 124 201 #	189 190 745	MAN	
	587 588 590		3400 124 301	468 469 472	MERCEDES-BENZ	
	591 592 593		3400 124 501	476 485 486		
	783 796			793 794		
3400 122 701 ⊕	347 348 349			MERCEDES-BENZ		
365 371 375	MERCEDES-BENZ	3400 124 601	10 11 12	DAF		
377 380 382	MERCEDES-BENZ	13 25 26				
386 388 389		3400 124 701	723	BOVA		
3400 122 801 ⊕		365 366 367	5 6 7	DAF		
368 369 371		MERCEDES-BENZ	8 19			
372 373 375			3400 124 801	4 6	DAF	
376 377 378			(1 3/4"-10N)			
379 380 381			3400 124 901	2 3 4	DAF	
382 383 384			(1 1/2"-10N)			
385 386 387			3400 125 001	477 478 485	MERCEDES-BENZ	
388 389 390			MERCEDES-BENZ	487 489 490		
391 392 393				505 506 511		
394 417 419				543 795		
420 421				3400 125 101 #	489 490 496	MERCEDES-BENZ
3400 122 901				514 515 516	497 498	
517 518 530				MERCEDES-BENZ		
534 535 547						
551 552 553						
554 559 561						
562 563 564						
565 566 572						
573 585 586						
587 588 592						
593						

Arithmetische Liste / Part number list

Artikelnummer Article No.	Seite Page	Hersteller Manufacturer	Artikelnummer Article No.	Seite Page	Hersteller Manufacturer
3400 125 201	347 348 349	MERCEDES-BENZ	3400 700 310	133 134 135	MAN
3400 125 501	197 198 199 201 202 203 204 205 206 207 300 757 758 655 656	MAN STEYR	(1 3/4"-10N)	136 137 138 140 145 146 147 148 149 150 151 157 159 160 161 165 169 324 759	
3400 125 601 ⊕	839 840 841	VOLVO	3400 700 311	613 614 615 616 617 618 619 623 636 637 638 639	RENAULT TRUCKS
3400 125 701	9 12 26 827	DAF SCANIA	3400 700 312	83	IVECO
3400 125 801	189 190 745 746	MAN	3400 700 313	72 75 76	IVECO
3400 125 901 ⊖	649 651 826 827 828	SCANIA	3400 700 316	18 20 21	DAF
3400 127 101 ⊕	684 685 686 707 708 709 710 711	VOLVO	3400 700 318 #	17	DAF
3400 127 201 ⊕	707 839 843	VOLVO	3400 700 319	19	DAF
3400 127 301 #	347 348 349	MERCEDES-BENZ	3400 700 320	15 16	DAF
3400 127 401	215 216 217 218 219 237 246 666 667	MAN STEYR	3400 700 322 ⊖	190 191 192 193 194 195 198 199 201 202 203 204 208 209 210 211 654 655 656 657 658	MAN STEYR
3400 127 601 (2"-10N)	134 135 136 137 139 140 141 142 143 144 145 146 147 148 149 150 151 152 153 154 155 157 158 159 160 161 162 163 164 165 166 167 168 169 170 171 208 324 598 599 600 601	MAN ÖSTERREICHISCHE AUTOMOBILFABRIK (ÖAF)	3400 700 323 ⊖	652	SCANIA
3400 127 701 ⊖	394 396 397 399 401 403 404 407 410 430 431 455 456 457 464 468 772 793	MERCEDES-BENZ	3400 700 324 ⊖	652	SCANIA
3400 127 801	733	EVOBUS	3400 700 325 ⊕	683 684 685 686 697	VOLVO
3400 128 001	779 782 783 784 785	MERCEDES-BENZ	3400 700 326 ⊕	684 685 686 708 709 710 711 717 719	VOLVO
3400 700 301 #⊕	147 694 695 696 712	MAN VOLVO	3400 700 327	118 144 145 168 174 177 178 180 181 182 184 185 186 187 188 189 217 218 219 220 221 222 223 224 225 226 227 228 229 230 231 232 233 234 235 237 238 239 240 241 242 243 244 245 246 257 258 259 260 261 262 263 264 265 266 267 268 269 270 271 272 273 274 275 276 277 278 279 280 281 282 283 284 285 286 287 288 289 290 291 292 293 294 295 296 297 298 299	KAMAZ MAN
3400 700 302 ⊖	210 212 213	MAN			
3400 700 303 ⊖	191 192 193 196 197 198 210 213 247 248 249 250 251 252	MAN			
3400 700 305	723 11 21 834	BOVA DAF VAN HOOL			
3400 700 307	15	DAF			
3400 700 308	15 16 18	DAF			

Artikelnummer Article No.	Seite Page	Hersteller Manufacturer	Artikelnummer Article No.	Seite Page	Hersteller Manufacturer
3400 700 328	736 738 823 825 826	IRISBUS RENAULT TRUCKS	3400 700 357 ⊕	686 718	VOLVO
3400 700 329	626 627 628 824	RENAULT TRUCKS	3400 700 358 ⊖	617 698 700 702 712	RENAULT TRUCKS VOLVO
3400 700 330	736 737 618 824 825	IRISBUS RENAULT TRUCKS	3400 700 359 ⊖	681 701 703 704 705 706 712	VOLVO
3400 700 331	619 620	RENAULT TRUCKS	3400 700 360 ⊕	681 682 683 685 686 687 690 698 700 701 702 703 704 705 706 708 709 710 711 712	VOLVO
3400 700 332	623 637	RENAULT TRUCKS	3400 700 361	20 24 29	DAF
3400 700 333	613 614 615 616 617	RENAULT TRUCKS	3400 700 362	746 751 754 758 760 761 762	MAN
3400 700 334	613 615 616 617 618 623 637	RENAULT TRUCKS	3400 700 364	236 249 251 252 253 254 255 256	MAN
3400 700 335 ▲	613	RENAULT TRUCKS	3400 700 365	85 86 87 93 94 95 96 97 99	IVECO
3400 700 336	603 608 610 640 641	RENAULT TRUCKS	3400 700 366	84 87 88 90 91 93 94 95 96 97 98 99 100 101	IVECO
3400 700 337	631 635	RENAULT TRUCKS	3400 700 368	20 24 29	DAF
3400 700 338	629 630	RENAULT TRUCKS	3400 700 370	653	SCANIA
3400 700 339	607 609 611 625 629 630 632 633 634 646 823	RENAULT TRUCKS	3400 700 371	653	SCANIA
3400 700 340	614 615 616 617 619 620	RENAULT TRUCKS	3400 700 372	653	SCANIA
3400 700 341 #	738 625 826	IRISBUS RENAULT TRUCKS	3400 700 373	653	SCANIA
3400 700 342 ⊕	685 686 699 701 707 708 709 710 711 718 840 842 843 844	VOLVO	3400 700 374	653	SCANIA
3400 700 343 ⊕	685 686 698 699 700 701 707 708 709 710 711 718	VOLVO	3400 700 375	15 16	DAF
3400 700 344	118	KAMAZ	3400 700 376	15 16 18	DAF
3400 700 345	117	KAMAZ	3400 700 377	84 85 94	IVECO
3400 700 347	104 105 106 107 739	IVECO	3400 700 378	85 86 94 95 96 98	IVECO
3400 700 348 ⊕	681 682 683 685 686 698 700 701 702 703 704 705 706 708 709 710 711 712	VOLVO	3400 700 379	802 803 804 805 808 809 811 812 813 814	NEOPLAN
3400 700 349	733	EVOBUS	3400 700 380	218 219 220 221 222 223 224 225 226 227 228 238 239 246 257 258 259 264 265 266 267 268 269 275 276 278 279 281 286 288 289 292 294 297 298	MAN
3400 700 350 ⊕	620 622 685 686 708 709 710 718 842 843 844	RENAULT TRUCKS VOLVO	3400 700 381	218 219 220 221 222 223 224 225 226 227 228 238 239 257 258 259 260 264	MAN
3400 700 351 ⊕	621 622 686 687 711 718	RENAULT TRUCKS VOLVO			
3400 700 352	652 653	SCANIA			
3400 700 353 #	15	DAF			
3400 700 354	827	SCANIA			
3400 700 355 ⊕	366 367 369 370 372 373 375 376 379 381 384 385 386 387 388 390 391 392	MERCEDES-BENZ			

Artikelnummer Article No.	Seite Page	Hersteller Manufacturer	Artikelnummer Article No.	Seite Page	Hersteller Manufacturer																					
3400 700 445	228 229 230	MAN	3400 700 460 HD	228 229 230	MAN																					
	231 232 233			231 232 233																						
	234 235 236			234 235 236																						
	240 241 242			240 241 242																						
	243 244 245			243 244 245																						
	246 247 248			246 247 248																						
	749			261 262 263																						
	817			265 269 270																						
	666			271 272 273																						
	666			274 276 277																						
3400 700 446 ⊕	366 367 369	MERCEDES-BENZ	3400 700 461	91 94 95	IVECO																					
	372 375 376			96 97 98																						
	379 381 385			99 100 101																						
	387 388 390			3400 700 462 ■ (41,25x52,1x10Z)		87 88 89	IVECO																			
	391 392 393					90 91 92																				
	415 416 417					3400 700 463 ⊕		681 682 683	VOLVO																	
	419 420							698 700 701																		
	3400 700 447 ■ (23x29-10N)							43 44		IVECO	702 703 704	3400 700 464	16 17	DAF												
								3400 700 448 ■ (23x29-10N)			42 44 45		IVECO		705 706 712	16 17	DAF									
											47 49				3400 700 466	635 638		RENAULT TRUCKS VOLVO								
3400 700 449 ■ (1 1/2"-10N)		53 55 56	IVECO		680 697						3400 700 467					20 24 25			DAF							
		57 58 59			3400 700 468 ⊕											369 370 374				MERCEDES-BENZ						
		60 61 62														379 384 385										
		63 64 65		386 387 392																						
		66 68		393																						
		631 632 634		RENAULT TRUCKS		3400 700 470	618 623		RENAULT TRUCKS																	
		3400 700 450					215 216 217									MAN					3400 700 471 ⊕	698 707	VOLVO			
	218 219 237						3400 700 472 ⊕			698		VOLVO														
	246							3400 700 473		15 16 17			DAF													
	799									3400 700 474 ■ (31,01x38,53-10Z)				53 59 65	IVECO											
666 667	3400 700 475 ■ (31,02x38,55-10Z)		53 59 65								IVECO															
3400 700 451			725 734		EVOBUS MERCEDES-BENZ									3400 700 476			15 16 18	DAF								
			790														3400 700 477 ☉		458	MERCEDES-BENZ						
			3400 700 452 ■ (1 1/2"-10N)																54 55 58			IVECO		3400 700 478 ⊕	681 698 700	VOLVO
																			59 62 64						701 702 703	
				65		704 705 706																				
		3400 700 454 ■ (41,1x50,8-10N)		81 101 102		IVECO			712							3400 700 479 ☉			638		RENAULT TRUCKS					
				103 112 113			3400 700 482 ■ (1 1/2" -10N)		634 635			RENAULT TRUCKS														
				3400 700 455 ■ (41,1x50,8-10N)				69 71 73	IVECO				3400 700 483 (23,05x30,57x10Z)						42 43 44				IVECO			
								75 103 113		46 47 48																
	115							50																		
3400 700 456 ■ (41,1x50,8-10N)	101 102 103				IVECO			3400 700 484 ☉		394 396 397	MERCEDES-BENZ															
	104 111 112									399 401 403																
	113 114		404 407 410																							
	3400 700 457 ■ (41,1x50,8-10N)		101 102 103							IVECO				431 455 456												
			104 111 112											457 464 468												
		113 114	477 486 772																							
		3400 700 459 HD	228 229 230			MAN	3400 700 484 ☉					394 396 397		MERCEDES-BENZ												
			231 232 233	399 401 403																						
			234 235 236	404 407 410																						
			240 241 242	431 455 456																						
243 244 245			457 464 468																							
246 247 261			477 486 772																							
262 263 271			3400 700 479 ☉	638	RENAULT TRUCKS																					
272 273 274	3400 700 482 ■ (1 1/2" -10N)			634 635				RENAULT TRUCKS																		
277 280 283				3400 700 483 (23,05x30,57x10Z)					42 43 44	IVECO																
284 285 287									46 47 48																	
290 291 293		50																								
296 297 299		3400 700 484 ☉				394 396 397	MERCEDES-BENZ																			
746 749						399 401 403																				
799 815 816						404 407 410																				
817						431 455 456																				
666						457 464 468																				
666			477 486 772																							
3400 700 447 ■ (23x29-10N)	43 44		IVECO		3400 700 484 ☉	394 396 397		MERCEDES-BENZ																		
	3400 700 448 ■ (23x29-10N)			42 44 45		IVECO			399 401 403																	
				47 49					404 407 410																	
				3400 700 449 ■ (1 1/2"-10N)					53 55 56	IVECO	431 455 456															
		57 58 59					457 464 468																			
		60 61 62					477 486 772																			
		63 64 65					RENAULT TRUCKS																			
		66 68							3400 700 483 (23,05x30,57x10Z)		42 43 44	IVECO														
		631 632 634									46 47 48															
		3400 700 450									215 216 217		MAN	50												
218 219 237			3400 700 484 ☉		394 396 397			MERCEDES-BENZ																		
246	399 401 403																									
799	404 407 410																									
666 667	431 455 456																									
3400 700 451	725 734			EVOBUS MERCEDES-BENZ	457 464 468																					
	790				477 486 772																					
	3400 700 452 ■ (1 1/2"-10N)				54 55 58	IVECO	3400 700 484 ☉			394 396 397	MERCEDES-BENZ															
					59 62 64				399 401 403																	
					65				404 407 410																	
		3400 700 454 ■ (41,1x50,8-10N)			81 101 102				IVECO	431 455 456																
			103 112 113		457 464 468																					
			3400 700 455 ■ (41,1x50,8-10N)		69 71 73			IVECO		477 486 772																
					75 103 113					RENAULT TRUCKS																
					115							3400 700 483 (23,05x30,57x10Z)	42 43 44	IVECO												
3400 700 456 ■ (41,1x50,8-10N)				101 102 103	IVECO								46 47 48													
				104 111 112									50													
	113 114			3400 700 484 ☉		394 396 397	MERCEDES-BENZ																			
	3400 700 457 ■ (41,1x50,8-10N)					101 102 103					IVECO		399 401 403													
						104 111 112							404 407 410													
		113 114				431 455 456																				
		3400 700 459 HD				228 229 230			MAN				457 464 468													
			231 232 233			477 486 772																				
			234 235 236			RENAULT TRUCKS																				
			240 241 242					3400 700 483 (23,05x30,57x10Z)		42 43 44		IVECO														
243 244 245			46 47 48																							
246 247 261			50																							
262 263 271			3400 700 484 ☉	394 396 397	MERCEDES-BENZ																					
272 273 274	399 401 403																									
277 280 283	404 407 410																									
284 285 287	431 455 456																									
290 291 293	457 464 468																									
296 297 299	477 486 772																									
746 749	3400 700 479 ☉	638		RENAULT TRUCKS																						
799 815 816		3400 700 482 ■ (1 1/2" -10N)				634 635	RENAULT TRUCKS																			
817						3400 700 483 (23,05x30,57x10Z)		42 43 44	IVECO																	
666								46 47 48																		
666			50																							
666			3400 700 484 ☉		394 396 397			MERCEDES-BENZ																		
666					399 401 403																					
666					404 407 410																					
666					431 455 456																					
666					457 464 468																					
666	477 486 772																									
666	RENAULT TRUCKS																									
666		3400 700 483 (23,05x30,57x10Z)		42 43 44	IVECO																					
666				46 47 48																						
666				50																						
666			3400 700 484 ☉	394 396 397		MERCEDES-BENZ																				
666				399 401 403																						
666				404 407 410																						
666				431 455 456																						
666				457 464 468																						
666				477 486 772																						
666	RENAULT TRUCKS																									
666		3400 700 483 (23,05x30,57x10Z)		42 43 44	IVECO																					
666				46 47 48																						
666				50																						
666			3400 700 484 ☉	394 396 397		MERCEDES-BENZ																				
666				399 401 403																						
666				404 407 410																						
666				431 455 456																						
666				457 464 468																						
666				477 486 772																						
666	RENAULT TRUCKS																									
666		3400 700 483 (23,05x30,57x10Z)		42 43 44	IVECO																					
666				46 47 48																						
666				50																						
666			3400 700 484 ☉	394 396 397		MERCEDES-BENZ																				
666				399 401 403																						
666				404 407 410																						
666				431 455 456																						
666				457 464 468																						
666				477 486 772																						
666	RENAULT TRUCKS																									
666		3400 700 483 (23,05x30,57x10Z)		42 43 44	IVECO																					
666				46 47 48																						
666				50																						
666			3400 700 484 ☉	394 396 397		MERCEDES-BENZ																				
666				399 401 403																						
666				404 407 410																						
666				431 455 456																						
666				457 464 468																						
666				477 486 772																						
666	RENAULT TRUCKS																									
666		3400 700 483 (23,05x30,57x10Z)		42 43 44	IVECO																					
666				46 47 48																						
666				50																						
666			3400 700 484 ☉	394 396 397		MERCEDES-BENZ																				
666				399 401 403																						
666				404 407 410																						
666				431 455 456																						
666				457 464 468																						
666				477 486 772																						
666	RENAULT TRUCKS																									
666		3400 700 483 (23,05x30,57x10Z)		42 43 44	IVECO																					
666				46 47 48																						
666				50																						
666			3400 700 484 ☉	394 396 397		MERCEDES-BENZ																				
666				399 401 403																						
666				404 407 410																						
666				431 455 456																						
666				457 464 468																						
666				477 486 772																						
666	RENAULT TRUCKS																									
666		3400 700 483 (23,05x30,57x10Z)		42 43 44	IVECO																					
666				46 47 48																						
666				50																						
666			3400 700 484 ☉	394 396 397		MERCEDES-BENZ																				
666				399 401 403																						
666				404 407 410																						
666				431 455 456																						
666				457 464 468																						
666				477 486 772																						
666	RENAULT TRUCKS																									
666		3400 700 483 (23,05x30,57x10Z)		42 43 44	IVECO																					
666				46 47 48																						
666				50																						
666			3400 700 484 ☉	394 396 397		MERCEDES-BENZ																				
666				399 401 403																						
666				404 407 410																						
666				431 455 456																						
666				457 464 468																						
666				477 486 772																						
666	RENAULT TRUCKS																									
666		3400 700 483 (23,05x30,57x10Z)		42 43 44	IVECO																					
666				46 47 48																						
666				50																						
666			3400 700 484 ☉	394 396 397		MERCEDES-BENZ																				
666				399 401 403																						
666				404 407 410																						
666				431 455 456																						
666				457 464 468																						
666				477 486 772																						
666	RENAULT TRUCKS																									
666		3400 700 483 (23,05x30,57x10Z)		42 43 44	IVECO																					
666				46 47 48																						
666				50																						
666			3400 700 484 ☉	394 396 397		MERCEDES-BENZ																				
666				399 401 403																						
666				404 407 410																						
666				431 455 456																						
666				457 464 468																						
666				477 486 772																						
666	RENAULT TRUCKS																									
666		3400 700 483 (23,05x30,57x10Z)		42 43 44	IVECO																					
666				46 47 48																						
666				50																						
666			3400 700 484 ☉	394 396 397		MERCEDES-BENZ																				
666				399 401 403																						
666				404 407 410																						
666				431 455 456																						
666				457 464 468																						
666				477 486 772																						
666	RENAULT TRUCKS																									
666		3400 700 483 (23,05x30,57x10Z)		42 43 44	IVECO																					
666				46 47 48																						
666				50																						
666			3400 700 484 ☉	394 396 397		MERCEDES-BENZ																				
666				399 401 403																						
666				404 407 410																						
666				431 455 456																						
666				457 464 468																						
666				477 486 772																						
666	RENAULT TRUCKS																									
666		3400 700 483 (23,05x30,57x10Z)		42 43 44	IVECO																					
666				46 47 48																						
666				50																						
666			3400 700 484 ☉	394 396 397		MERCEDES-BENZ																				
666				399 401 403																						
666				404 407 410																						
666				431 455 456																						

Arithmetische Liste / Part number list

Artikelnummer Article No.	Seite Page	Hersteller Manufacturer	Artikelnummer Article No.	Seite Page	Hersteller Manufacturer
3400 700 485 #	613 614 615 616 617 618 654	RENAULT TRUCKS SISU	3400 700 529 ☞☛ (45x50-18N)	354 359 360 363 364 368 373 374 378 383 391	MERCEDES-BENZ
3400 700 487	53 59 65	IVECO	3400 700 530 ☞☛ (45x50-18N)	355 356 361 362 367 373 374 377 382 388 389	MERCEDES-BENZ
3400 700 489	28 29	DAF	3400 700 531 ☞☛ (45x50x-18N)	357 358 364 371 374 375 380 422 791 792	MERCEDES-BENZ
3400 700 490	680 681	VOLVO	3400 700 532 ☛ (45x50-18N)	355 356 361 362 367 373 374 377 382 388 389	MERCEDES-BENZ
3400 700 491	653	SCANIA	3400 700 533 ☛ (45x50-18N)	357 358 364 371 374 375 380 422	MERCEDES-BENZ
3400 700 493	736 823	IRISBUS RENAULT TRUCKS	3400 700 534 ☛ (45x50-18N)	354 359 360 363 364 368 373 374 378 383 391	MERCEDES-BENZ
3400 700 494	291	MAN	3400 700 535 ☛	354 360 364	MERCEDES-BENZ
3400 700 495 #	638	RENAULT TRUCKS	3400 700 537 ☞☛ (45x50-18N)	791 792	MERCEDES-BENZ
3400 700 497	736 737 738	IRISBUS	3400 700 600 ⊕	604 612 644 681 682 683 703 704 706	RENAULT TRUCKS VOLVO
3400 700 498 ☞	732 733 734	EVOBUS	3400 700 603	16 17	DAF
3400 700 504 ☛ (41,1x50,8-10N)	19 20 21 22 23 28 29	DAF	3400 700 604	24	DAF
3400 700 505 ☛ (41,1x50,8-10N)	746 762 799 818 820 821 822	MAN NEOPLAN	3400 700 605	24 25	DAF
3400 700 506 ☛ (41,1x50,8-10N)	747 748 760 761 820 821 822	MAN NEOPLAN	3400 700 606	50	IVECO
3400 700 507 ☛ (41,1x50,8-10N)	747 748 761 762 763 817 819 820 821 822	MAN NEOPLAN	3400 700 607	50	IVECO
3400 700 509 ☛ (41,1x50,8-10N)	733 789 790 791 792 799 820 821 828 829 830 831 832	EVOBUS MERCEDES-BENZ NEOPLAN SETRA	3400 700 608	50	IVECO
3400 700 510 ☛ (38,2x44,5-10N)	749 750 751 799	MAN NEOPLAN	3400 700 609	354 360 364	MERCEDES-BENZ
3400 700 511 ☞☛ (41,1x50,8-10N)	746 762 799 817 818 819 820 821 822	MAN NEOPLAN	3400 700 611	654	SCANIA
3400 700 512 ☞☛ (41,1x50,8-10N)	747 748 762 830 831	MAN SETRA	3400 700 613	256 287	MAN
3400 700 514 ☞☛ (23x29-10N)	42 43 44 45 46 47 48 49 50	IVECO	3400 700 614	256 287	MAN
3400 700 515 ☞☛ (23x29-10N)	42 44 45 46 47 49 50	IVECO	3400 700 615 ⊕	422	MERCEDES-BENZ
3400 700 519 ☛ (38,2x44,5-10N)	15 16 18 20 21	DAF	3400 710 001	172 190 191 192 193 194 195 198 199 201 203 204 208 209 210 211 256 654 655 656 657 658	STEYR
3400 700 520 ☛ (38,2x44,5-10N)	20	DAF	3400 710 002	191 192 193 196 197 198	MAN
3400 700 521 ☛ (41,1x50,8-10N)	20 24 29	DAF	3400 710 003	212	MAN
3400 700 522 ☛ (41,1x50,8-10N)	20 24 25 29 30	DAF	3400 710 004	652	SCANIA
3400 700 523 ☛ (38,2x44,5-10N)	15 16 18	DAF	3400 710 005	394 396 397 399 401 403 404 407 410	MERCEDES-BENZ
3400 700 524 ☛ (38,2x44,5-10N)	15 18	DAF	3400 710 006	394 396 397 399 401 403 404 407 410 412 415 416 418 419 420	MERCEDES-BENZ
3400 700 525 ☞☛ (41,1x50,8-10N)	831 832	SETRA	3400 710 007	396 397 399 401 403 404	MERCEDES-BENZ
3400 700 526 ☛	34	FREIGHTLINER			
3400 700 527 ☛ (30,7x38,4-10N)	15 16 18	DAF			

Artikelnummer Article No.	Seite Page	Hersteller Manufacturer	Artikelnummer Article No.	Seite Page	Hersteller Manufacturer				
3400 710 008	394 396 397	MERCEDES-BENZ	3459 018 004	620 621	RENAULT TRUCKS VOLVO				
	399 401 403			686 687 688					
	404 407 410			689 691 700					
	430 431			702 703 705					
3400 710 009	394 396 397	MERCEDES-BENZ	3474 012 000	706 708 709	VOLVO				
	399 401 403			710 711					
	404 407 410			674 676 694					
	412 415 416			695 696 716					
3400 710 010	418 419	MERCEDES-BENZ	3474 012 001	717 718 841	VOLVO				
	396 397 399			3474 012 003		677	VOLVO		
	401 403 404					3482 000 209		118	KAMAZ SISU VAN HOOL
	406 407 409							654	
410 411 412	836								
413 414 415	3482 000 246	228 229 230	MAN						
416 418 419		231 232 233							
420		234 235 236							
3400 710 011		247 248 249		MAN	240 241 242				
	250 251 252	243 244 245							
3400 710 012	396 397 416	MERCEDES-BENZ	246 247 260						
3400 710 013	396 397 416	MERCEDES-BENZ	261 262 263						
3400 710 014	396 397 399	MERCEDES-BENZ	265 269 270						
	401 403 404		271 272 273						
3400 710 015	407 410 416	MERCEDES-BENZ	274 276 277						
	396 397 399		280 282 283						
3400 710 016	401 403 404	MERCEDES-BENZ	284 285 287						
	407 410 416		289 290 291						
3400 710 017	394 396 397	MERCEDES-BENZ	292 293 295						
	399 401 403		296 297 298						
3400 710 060	404 407 410	MERCEDES-BENZ	299 746 749						
	416		799 815 816						
3400 710 061	396 397 399	MERCEDES-BENZ	817						
	401 403 404		622						
3400 710 062	407 410 416	MERCEDES-BENZ	666						
	615 616 638		RENAULT TRUCKS	3482 000 251	652 827	SCANIA			
639	VOLVO	3482 000 257		652 653 654	SCANIA				
698 699 700		VOLVO	3482 000 270 #	627 631	RENAULT TRUCKS				
701 840 844	VOLVO		3482 000 361	215 216 217	MAN				
845		VOLVO	218 219 220	221 222 223					
3400 710 063	618 623 638		RENAULT TRUCKS	224 225 226					
	639	VOLVO		227 228 237					
682 683 700	VOLVO		238 239 246						
702 703 705		VOLVO	257 258 259						
844 845	VOLVO		260 264 265						
3400 710 064		690	VOLVO	266 267 268					
	604 612 644	RENAULT TRUCKS		269 270 275					
681 682 683	VOLVO		276 278 279						
703 704 706		VOLVO	281 282 286						
3400 710 065	689 690		VOLVO	288 289 290					
	782 783	MERCEDES-BENZ		292 294 295					
3421 601 012	830 831		SETRA	297 298 747					
3421 601 016	830 831	SETRA	748						
3421 601 049	458	MERCEDES-BENZ	799 800 816						
3421 601 050	830 831	SETRA	817 818 819						
3421 601 069	458	MERCEDES-BENZ	820 821 822						
3459 000 009	674 676 694	VOLVO	666 667						
	695 696 716		3482 000 419	15 16 17					
717 718	VOLVO	50 53 59							
3459 004 108		650	SCANIA	65					
3459 010 101	675 717	VOLVO	117						
	676 717 719		VOLVO	721					
3459 012 131	677	VOLVO		KAMAZ YaMZ					
3459 016 031	677 688 689	VOLVO							
3459 017 031	676 683 684	VOLVO	3482 000 461	1 2	AVIA				

Arithmetische Liste / Part number list

Artikelnummer Article No.	Seite Page	Hersteller Manufacturer	Artikelnummer Article No.	Seite Page	Hersteller Manufacturer		
3482 000 462	394 396 397	MERCEDES-BENZ	3482 000 573	736 737	IRISBUS IVECO		
	399 401 403			85 86 87			
	404 407 410			88 89 90			
	430 431 454			91 92 93			
	455 456 457			94 95 96			
	464 465 468			97 98 99			
	469 472 477			3482 000 589		653 654	SCANIA
	486 493 772			3482 000 628		84 85 94	IVECO
793 794	3482 000 664	247 248 249	MAN				
3482 000 463	118	KAMAZ MAZ	3482 000 679	250 251 252	MAN		
	325 326			236 249 251			
	396 397 399	MERCEDES-BENZ	252 253 256	MERCEDES-BENZ RENAULT TRUCKS			
	401 403 404		458				
	406 407 409	3482 000 691	622	MAN			
	410 411 412	3482 000 819	291	MAN			
	413 414 415	3482 000 851	829 830	SETRA			
	416 418 419	3482 000 852	783 791	MERCEDES-BENZ SETRA			
	420 431 455		828 829 830				
	789 791	NEOPLAN TAM TEMSA	832	DAF			
	806		3482 000 859		15 16 17		
	832 833		3482 000 865		690	VOLVO	
833	3482 000 464	KING LONG MAN MERCEDES-BENZ	3482 000 953	6 14	DAF MERCEDES-BENZ		
741				475 477 478			
210 212 213				480 481 485			
394 396 397				487 488 489			
399 401 403				490 505 506			
404 407 410				511 536 543			
412 415 416				795			
418 419 420				3482 000 999		653 654	SCANIA
845	3482 000 467	YUTONG MAN	3482 001 145	256 287	MAN		
172 191 207			3482 001 165	689 690	VOLVO		
208 209 210			3482 001 166	16 17	DAF		
211 212 213			3482 001 169	604 612 644	RENAULT TRUCKS VOLVO		
214 236 249				681 682 683			
253 254 255				703 704 706			
256			3482 001 171	24 25	DAF		
656 657 658				3482 001 172		50	IVECO
660				3482 001 174		50	IVECO
3482 000 474				2		BMC DAF	3482 001 180
			15 16 17	3482 001 184	24		DAF
			18 24	3482 001 234 #	648 649 651		SCANIA
3482 000 484	20 24 25	826 827 828					
	29 30	3482 002 233 #	826	RENAULT TRUCKS			
3482 000 546	236 249 251		MAN		3482 002 234	3 4 5	DAF
	252 253 254					7	
	255 256	68 107 108		IVECO MAGIRUS-DEUTZ			
3482 000 552	615 616 617	RENAULT TRUCKS	123 125 126		MAN		
	638 639		127 128 129				
	698 699 700		300 301 302				
	701 702 712		303 304 305				
	840 844 845		308 312				
3482 000 553	618 623 638	RENAULT TRUCKS	441 445 446	MERCEDES-BENZ			
	639		447 448 449				
	681 682 683	VOLVO	450	NEOPLAN RENAULT TRUCKS			
	700 701 702		806				
	703 704 705		611 642				
	706 712 844		3482 002 239 #		445 446 447	MERCEDES-BENZ	
	845		452 453				
3482 000 572	84 87 88	IVECO	3482 006 036 #	8	DAF MAN NEOPLAN		
	90 91 93			751 752 753			
	94 95 96			754 755 756			
	97 98 99			798 800 801			
	100 101						

Artikelnummer Article No.	Seite Page	Hersteller Manufacturer	Artikelnummer Article No.	Seite Page	Hersteller Manufacturer			
3482 008 032	423 424 425	MERCEDES-BENZ	3482 018 132 #	8 9 11	DAF			
	426 427 434			12 13 21				
	435 436 437			25 26				
	438 439 440			803 804				
3482 008 033	68 76 106	IVECO	3482 021 031	827	NEOPLAN SCANIA VAN HOOL			
	740			834				
	123 742	MAGIRUS-DEUTZ RENAULT TRUCKS		654		SISU		
	611 629 632			673 681 692		VOLVO		
3482 008 034	3 5	DAF	693 714 838	839 842				
3482 008 036 #	76 77 106	IVECO	3482 026 332	675 717	VOLVO			
	124 125		3482 032 331	189 190 745	MAN			
	667		3482 033 401	650	SCANIA			
3482 008 038	349 350 437	MERCEDES-BENZ	3482 037 141	602 606 607	RENAULT TRUCKS			
	463 464 465		609 610 625					
	467 468 469		630 631 634					
	471 472 473		635 642 643					
	474 475 476		644 647 823					
	478 479 480		824					
	485 486 487		3482 038 031	68 76 77		IVECO		
	488 493 495		82 106 107					
	496 510 773		124	MAGIRUS-DEUTZ				
	784 793 794		799	NEOPLAN		3482 042 041	115	IVECO
	3482 008 110		302 305	MAN		3482 043 134	101 102 110	IVECO
3482 008 141 #	201 202 203	MAN	3482 046 031 #	349 463 464	MERCEDES-BENZ			
	204		3482 051 131 #	469 477 478	MERCEDES-BENZ			
3482 008 244	698	VOLVO	485 486 489	490 494 496				
3482 011 331 #	6 14	DAF MERCEDES-BENZ	497 498 506	530 535 536				
	475 480 481		794 795					
	489 490 496		3482 051 132 #	482	MERCEDES-BENZ			
	497 498 536		3482 054 131	347 348 349	MERCEDES-BENZ			
	795		769					
3482 012 211	728 729	EVOBUS MAGIRUS-DEUTZ MERCEDES-BENZ	3482 055 132	735	IKARUS MERCEDES-BENZ			
	742		347 348 349					
	428 429 430		769 770					
	441 442 450		3482 056 031	674 676 694	VOLVO			
	468 469 472		695 696 716					
	474 475 476		717 718					
	479 480 485		3482 059 031	676 717 719	VOLVO			
	486 488 495		3482 060 132	2 3 4	DAF			
	496 793 794		6 14 17					
	814		197 198 199					
3482 012 237	440 441 442	201 202 203	MAN					
443 444 448	204 205 206							
449 450	207 300 745							
3482 012 238	740	IVECO	750 752 757					
3482 012 240	469 472 477	MERCEDES-BENZ	758					
	480 485 486		655 656	STEYR				
	487 493 773		124	MAGIRUS-DEUTZ				
	784 793		190 302 305	MAN				
	3482 017 033		302 305 308	MAN	308			
3482 017 034	723	BOVA DAF	805 806	NEOPLAN				
	5 6 7							
	8 19	MAN	3482 062 035	748 749 750	MAN			
	201 202 203		808 809 811	NEOPLAN				
	204 205 206		812 813					
	207 208		3482 063 101 #	655 656 657	STEYR			
3482 017 035	5 7 8	DAF MAN	3482 067 101 #	657 658	STEYR			
	201 202 203		3482 067 102 #	659	STEYR			
	204 205 206	3482 071 131	677	VOLVO				
	207 208	3482 078 132	736 737 738	IRISBUS				
	594	ÖSTERREICHISCHE						

Arithmetische Liste / Part number list

Artikelnummer Article No.	Seite Page	Hersteller Manufacturer	Artikelnummer Article No.	Seite Page	Hersteller Manufacturer			
3482 078 133	133 134 135	MAN	3482 081 233	730 731 732	EVOBUS			
	136 137 138			733 734				
	139 140 141			510 514 515		MERCEDES-BENZ		
	142 143 144			516 517 518				
	145 146 147			530 534 535				
	148 149 150			547 551 552				
	151 152 153			553 554 559				
	154 155 157			561 562 563				
	158 159 160			564 565 566				
	161 162 163			572 573 585				
	164 165 166			586 587 588				
	167 168 169			592 593 783				
	170 171 208			784 790 792				
	324 759					3482 083 032	1	ASTRA BOVA DAF
	598 599 600			ÖSTERREICHISCHE AUTOMOBILFABRIK (ÖAF)			722	
	601						19 20 21	
	3482 078 134			736 738		IRISBUS IVECO	22 23 26	EVOBUS
				61 63 65			27 28 29	
66 67 68		723						
69 70 71		731 732 733	IVECO					
72 73 74		734						
84 86 88		69 70 71						
91 93 94		72 73 74						
95 97 98		75 86 87						
823 826		90 91 92		RENAULT TRUCKS				
		94 95 96						
	97 98 99							
	100 103 111							
	113 115							
	118	KAMAZ MAN						
	134 135 136							
	137 138 139							
	140 141 142							
	143 144 145							
	146 149 150							
	152 153 154							
	155 156 157							
	158 159 160							
	161 162 163							
3482 081 231	725 734	EVOBUS MERCEDES-BENZ	164 165 166	KAMAZ MAN				
	483 484 508		167 168 169					
	509 513 514		170 171 172					
	515 516 517		173 174 175					
	518 526 527		176 177 178					
	532 534 545		179 180 181					
	546 547 549		182 183 184					
	550 551 552		185 186 187					
	553 554 557		188 189 207					
	558 559 560		208 256 307					
	561 562 563		313 317 324					
	564 565 566		746 747 748					
	569 570 571		749 750 751					
572 573 581	754 755 756							
582 583 585	757 758 759							
586 587 588	760 761 762							
590 591 592	763	MAZ MZKT NEOPLAN						
593 772 776	326 764							
779 782 783	594							
784 785 789	798 799 800							
790 796	802 803 804							
	805 808 809							
	811 812 813							
	814 815 816							
3482 081 232	732 733		EVOBUS MERCEDES-BENZ					
	481 482 483							
	484 490 491							
	492 493 501							
	506 507 508							
	509 511 512							
	513 520 521							
	522 524 525							
	529 531 532							
	542 543 544							
	545 546 547							
	548 549 550							
	552 557 558							
561 564 565								
569 580 581								
583 585 587								

Artikelnummer Article No.	Seite Page	Hersteller Manufacturer	Artikelnummer Article No.	Seite Page	Hersteller Manufacturer
3482 083 034	615 616 617 618 622 638 639	RENAULT TRUCKS	3482 097 141	602 603 604 605 606 608 609 610 623 624 625 626 627 639 640 641 645 646 824 826	RENAULT TRUCKS
3482 083 039	650 651 652 827 828	SCANIA	3482 101 032	694 695 696 712 839 840 841	VOLVO
3482 083 040	737 81 101 102 103 104 110 111 112 113 114 116 133	IRISBUS IVECO	3482 102 031	189 190 745 746	MAN
3482 083 044	737 738 603 604 605 606 625 626 627 628 645 824 825 826	MAGIRUS-DEUTZ IRISBUS RENAULT TRUCKS	3482 106 031	445 446 447 450 451 452 453 454	MERCEDES-BENZ
3482 083 113	2 723 14 30 726 732 733 72 75 76 83 739 659 660 661	BMC BOVA DAF ENASA EVOBUS IVECO	3482 106 133	444 445 446 447 448 449 450	MERCEDES-BENZ
3482 083 118	741 117 118 741 326 802 807 808 809 810 811 812 813	IVECO KAMAZ LAZ MAZ NEOPLAN	3482 110 031	677 688 689	VOLVO
3482 083 150	652 827	SCANIA	3482 111 031	683 684 697 700 702 703 705 706	VOLVO
3482 083 252	735 736 737 613 614 615 616 617 618 619 620 623 635 636 637 823 824 825	IRISBUS RENAULT TRUCKS	3482 111 032	676 684 708 709 710 711 717 719	VOLVO
3482 085 033	83 104 108 109 112 114 115 116 117 739 740 834	IVECO VAN HOOL	3482 112 031	651 652 827 828	SCANIA
3482 085 034	752 755 756	MAN	3482 114 031	118 144 145 168 172 174 175 176 177 178 179 180 181 182 183 184 185 186 187 188 189 217 218 219 220 221 222 223 224 225 226 227 228 229 230 231 232 233 234 235 237 238 239 240 241 242 243 244 245 246 257 258 259 260 261 262 263 264 265 266 267 268 269 270 271 272 273 274 275 276 277 278 279 280 281 282 283 284 285 286 287 288 289 290 291 292 293 294 295 296 297 298 299 309 594 595 596 597 598 599 600 659 660 661	KAMAZ MAN
3482 086 132	745 750 754 760	MAN	ÖSTERREICHISCHE AUTOMOBILFABRIK (ÖAF)	STEYR	
3482 092 031	51 52 53 68 631 632	IVECO RENAULT TRUCKS			
3482 093 031	57 59 61 63 64 65 66 67 68	IVECO			
3482 093 032	190 191 192 193 194 195 198 199 201 202 203 204 208 209 210 211 654 655 656 657 658	MAN STEYR			
3482 094 031 #	53 55 56 57 58 59 60 61 62	IVECO			

Artikelnummer Article No.	Seite Page	Hersteller Manufacturer	Artikelnummer Article No.	Seite Page	Hersteller Manufacturer
3482 124 542	30 725	ENASA	3483 000 259 ⊕	653	SCANIA
3482 124 549	731	EVOBUS	3483 000 348	604 612 644	RENAULT TRUCKS
	751 753 760	MAN		681 682 683	VOLVO
	834 835	VAN HOOL		698 700 701	
	845	YUTONG		702 703 704	
3482 124 550	8	DAF		705 706 712	
	752 753 754	MAN	3483 000 382	681 698 700	VOLVO
	755 756			701 702 703	
	798 800 801	NEOPLAN		704 705 706	
	802 814 815			712	
3482 124 731	652	SCANIA	3483 000 422	369 370 374	MERCEDES-BENZ
3482 125 131	79 80 81	IVECO		379 384 385	
	82 83 104			386 387 392	
	108 109 110			393	
	111 112 113		3483 000 461 ⊕	417	MERCEDES-BENZ
	114 115 116		3483 010 137 ⊕	110	IVECO
	117 740		3483 010 138 ⊕	101 102	IVECO
	133	MAGIRUS-DEUTZ	3483 014 131	695 696	VOLVO
3482 125 132	1	ASTRA	3483 014 132	674 676 694	VOLVO
3482 125 245	104 105 106	IVECO		695 696 716	
	107 739			717 718 841	
3482 125 512	1	AVIA	3483 017 031	676 717 719	VOLVO
	325	MAZ	3483 019 031 #⊕	649 651	SCANIA
	823	PAZ	3483 020 033	650 651	SCANIA
3482 602 002	691 692 693	VOLVO	3483 020 034 ⊕	110 112 113	IVECO
3482 602 003	691 692 693	VOLVO		116	
3482 602 005	691	VOLVO		133	MAGIRUS-DEUTZ
3482 602 006	691	VOLVO	3483 020 035 ⊕	81 116	IVECO
3482 602 008	692 693	VOLVO		133	MAGIRUS-DEUTZ
3482 634 003	635 638	RENAULT TRUCKS	3483 020 036	651 827	SCANIA
	680 697	VOLVO	3483 022 031	147	MAN
3482 634 004	618 623 639	RENAULT TRUCKS		694 695 696	VOLVO
3482 634 005	680 681	VOLVO		712	
3482 905 001	76 107	IVECO	3483 022 032	839 840 841	VOLVO
	692	VOLVO	3483 023 001 ⊕	146 147 148	MAN
3482 907 001	34 35 36	IVECO		150 151 152	
	37 38 40			154 155 156	
	41 738			157 158 161	
3482 909 001 #	681 692 693	VOLVO		162 163 164	
	838 842			165 167	
3482 911 001	50 104 105	IVECO		571 573 589	MERCEDES-BENZ
	739			598 599 600	ÖSTERREICHISCHE AUTOMOBILFABRIK (ÖAF)
3482 934 001	668	VOLKSWAGEN		604 605 606	RENAULT TRUCKS
3482 998 701	34 36 37	IVECO		640	
	38 40 41		3483 023 003 ⊕	75	IVECO
	50 739			145 146 147	MAN
3483 000 001 ⊕	117	KAMAZ		149 151 152	
3483 000 139 ⊕	365 366 367	MERCEDES-BENZ		153 154 155	
	368 369 370			156 159 161	
	371 372 373			162 181 183	
	374 375 376			184 186 187	
	379 380 381			188 189	
	382 383 384			597 598 599	ÖSTERREICHISCHE AUTOMOBILFABRIK (ÖAF)
	385 386 387				
	388 389 390		3483 023 032 ⊕	515 516 517	MERCEDES-BENZ
	391 392 393			518 534 535	
	412 413 414			552 563 564	
	415 416 419			565 566 569	
	420			585 586 587	
3483 000 258	366 367 369	MERCEDES-BENZ		588 593	
	372 375 376		3483 024 031 ⊕	651 652	SCANIA
	379 381 385				

Arithmetische Liste / Part number list

Artikelnummer Article No.	Seite Page	Hersteller Manufacturer	Artikelnummer Article No.	Seite Page	Hersteller Manufacturer
3483 027 231	683 684 685 686 697	VOLVO	3488 000 108 #⊕	836	VAN HOOL
3483 027 332 ⊕	676 684 685 686 700 702 703 705 706 708 709 710 711 717 719	VOLVO	3488 000 122	620 621 622	RENAULT TRUCKS
3483 028 031	651 828	SCANIA	3488 000 158	366 367 369 370 372 373 375 376 379 381 384 385 386 387 388 390 391 392 393 421 563	MERCEDES-BENZ
3483 030 031 ⊕	365 371 375 377 380 382 386 388 389 412 413 414 415 416 419 420 422	MERCEDES-BENZ	3488 000 159	681 682 683 685 686 687 690 698 700 701 702 703 704 705 706 708 709 710 711 712	VOLVO
3483 030 032 ⊕	365 366 367 368 369 370 371 372 373 374 375 376 377 378 379 380 381 382 383 384 385 386 387 388 389 390 391 392 393 394 417 419 420 421 772	MERCEDES-BENZ	3488 000 366	354 360 364	MERCEDES-BENZ
3483 034 032 ⊕	674 681 694 695 696 716 718 840 841 842	VOLVO	3488 007 631	675 717	VOLVO
3483 034 033 ⊕	676 683 684 685 686 697 698 699 701 707 708 709 710 711 718 839 840 842 843 844	VOLVO	3488 009 634	650	SCANIA
3483 034 034 ⊕	684 685 686 698 699 701 707 708 709 710 711 718	VOLVO	3488 013 138 ⊕	674 676 694 695 696 716 717 718 841	VOLVO
3483 034 035	637 686 718	RENAULT TRUCKS VOLVO	3488 016 031	677	VOLVO
3483 034 042 ⊕	620 622 685 686 707 708 709 710 718 840 842 843 844	RENAULT TRUCKS VOLVO	3488 017 333	135 137 138 139 140 141 142 143 144 145 146 147 148 149 150 151 152 153 154 155 156 157 158 163 164 167 168 600	MAN ÖSTERREICHISCHE AUTOMOBILFABRIK (ÖAF) VAN HOOL
3483 034 043	621 622 686 687 711 718	RENAULT TRUCKS VOLVO	3488 017 334	605 606 619 621 624 628	RENAULT TRUCKS
3483 034 044 ⊕	839	VOLVO	3488 017 410	732 734 801 802 803 804 813 814	EVOBUS NEOPLAN
3483 034 045 ⊕	839 840 841	VOLVO	3488 017 432	384 509 510 514 515 516 517 518 530 535 547 551 552 553 554 559 560 561 562 563 564 565 566 570 571 572 573 583 585 586 587 588 593	MERCEDES-BENZ
3483 034 135 ⊕	685 686 687 688 689 691 700 702 703 705 706 708 709 710 711	VOLVO	3488 017 439	613 614 615 616 617 618 619 620 621 623 636 637 638 639 654	SISU
3488 000 024	685 686 687 690 708 709 710 711 718	VOLVO	3488 017 442	621	RENAULT TRUCKS
3488 000 102 ⊕	366 368 369 370 372 373	MERCEDES-BENZ	3488 017 447	173 178 182 184 185 187 188 189 217 218 219 235	MAN

Arithmetische Liste / Part number list

Artikelnummer Article No.	Seite Page	Hersteller Manufacturer	Artikelnummer Article No.	Seite Page	Hersteller Manufacturer
6594 000 171	737	IRISBUS			
6594 000 211	737	IRISBUS			
6594 000 218	791 792	MERCEDES-BENZ			
6594 000 219	791 792	MERCEDES-BENZ			

Vergleichsliste / Cross reference list

Vergleichs-Nr. Compare No.	Artikelnummer Article No.	Vergleichs-Nr. Compare No.	Artikelnummer Article No.	Vergleichs-Nr. Compare No.	Artikelnummer Article No.
ASTRA		BMC		BOVA	
100127	1878 001 070	4K207089	1861 526 046	267747	1878 080 037
101647	1878 002 706	4K207089	1878 002 955	267748	1878 080 034
101648	1878 002 878	52RS020389	3482 114 031	270054	1878 002 878
101649	1878 634 014	52RS020390	1878 080 034	270074	1878 054 933
101651	3151 208 001	52RS020391	3151 263 031	270574	1878 080 037
101652	3151 111 032	53RS400002M	3482 083 118	276261	1878 080 037
101653	1805 042 000	53RS400003M	1878 080 031	30034361	1878 080 037
104671	1866 030 102	53RS400004	3151 000 157	41154221	3151 000 335
108592	1882 306 242	53RS400004M	3151 000 157	41376143	1878 027 231
112320	1862 305 033	53RS410961	3482 000 474	41689108	1878 054 933
112447	1878 000 959	53RS410962	1878 003 899	512363	1878 003 657
112590	1878 001 070	53RS410963	3151 000 512	512364	1878 003 657
113100	1878 000 961	54RS410140	3482 000 461	DAEWOO	
113795	1878 002 878	54RS410141	1878 079 331	M408541	3151 199 001
114300	3482 083 032	57RS306250M	3151 000 157	DAF	
11870	3151 204 001	57RS309027M	1878 002 955	ACHC289	3482 602 008
122422	3400 117 801	BOVA		ATRA446	1878 600 563
122442	3400 117 801	1155874	3151 000 335	ATRB 246	3151 000 397
122531	3482 124 516	187090	3151 000 395	ATRB 247	3151 000 395
122739	3482 125 132	187091	3482 119 032	ATRB 257	3482 000 419
122744	1888 063 137	193852	1878 080 037	ATRB 546	3151 000 397
122745	3482 125 131	193853	3482 083 113	ATRB075	1878 004 100
123102	1862 304 033	193853	3482 083 118	ATRB077	1878 003 332
123156	1878 085 741	193854	3151 217 001	ATRB560	1878 005 600
123157	3151 000 144	193854	3151 217 001	ATRB562	1878 005 599
123443	1878 051 801	20212049	3482 119 031	ATRB563	3482 000 474
123762	1878 054 951	20216212	3151 273 601	ATRB597	1878 005 601
123762	1878 054 951	20220944	1878 003 269	ATRB598	3482 000 859
123762	1878 054 951	20223808	3482 119 032	ATRC239	3482 001 166
126 947	3483 023 001	20223810	3151 182 233	ATRC342	1878 007 172
151517	1878 054 951	202378	1878 002 706	0067894	3151 204 001
151517	1878 054 951	202379	1878 003 269	0078866	3482 119 031
151524	1878 634 016	20257128	3482 083 032	0096004	1878 003 276
151525	3482 083 034	20267747	1878 080 037	0113365	3151 000 515
154381	3151 208 001	20270074	1878 054 933	0117875R	1882 330 032
155873	3482 125 131	20270574	1878 080 037	0117875R	3482 124 541
20258	1878 000 959	20330503	3151 000 157	0160795	1882 137 307
20259	3151 111 032	20330806	1878 080 037	0165495	1878 001 138
30194	3482 125 132	20330807	1878 080 037	0279810	3151 199 001
30194	3482 125 132	212049	3482 119 031	0286877	3482 060 132
30196	3151 000 515	212053	3151 182 233	0286877R	3482 060 132
55010	1878 002 955	216169	3482 119 031	0376491	3482 017 034
AVIA		216169	3482 119 031	0376491R	3482 017 034
402-150031	3482 000 461	216212	3151 273 601	0514455	3163 030 100
402-150101	1878 019 001	220944	1878 003 269	0521458	1878 003 269
402-150102	1878 000 515	223809	1878 027 231	0615808	3163 026 100
431202003	3482 125 512	223810	3151 182 233	0615932	3482 017 035
431312002	1878 019 001	223811	1878 002 878	0641350	3482 118 031
442-17050-018-7	1878 000 611	223971	3482 124 522	0660306	3482 000 953
BMC		234502	1878 054 933	0660306	3482 011 331
4K207088	1882 346 131	239354	1878 080 034	070763	3151 182 031
		257128	3482 083 032		

Vergleichsliste / Cross reference list

Vergleichs-Nr. Compare No.	Artikelnummer Article No.	Vergleichs-Nr. Compare No.	Artikelnummer Article No.	Vergleichs-Nr. Compare No.	Artikelnummer Article No.
DAF		DAF		DAF	
072654	1878 003 269	1304278	1878 002 071	1395699R	1878 000 105
072655	1878 003 269	1304280	3482 000 419	1395700R	1878 001 152
072656	1878 003 269	1304280R	3482 000 419	1395703	1878 086 741
0740782	1878 003 269	1307569	1878 044 631	1395703	1878 086 741
0740783	1878 002 706	1310137	3151 199 001	1395703R	1878 086 741
0740784	1878 002 706	1310896	3482 119 031	1395703R	1878 086 741
0740784R	1878 002 706	1310896R	3482 119 031	1395704R	1878 027 231
0740787	1878 003 657	1310897	3482 119 032	1395705	1878 003 269
0740788	1878 003 657	1310897R	3482 119 032	1395705R	1878 003 269
0740788R	1878 003 657	1311497	3151 263 031	1395706	1878 003 657
0740794	1878 001 070	13242345	1878 054 933	1400510	1878 079 331
0751952	1878 000 105	1326842	1878 027 231	1402466	3151 000 397
0751953	1861 777 037	1328793	3496 006 000	1409 363	1878 004 100
0751954	1861 777 043	1329459R	3482 083 032	1409 478	1878 079 331
0755079	1878 002 878	1329549	3482 083 032	1409364R	3482 000 419
078542	1878 003 269	1329549R	3482 083 032	1409478R	1878 079 331
078544	3482 081 231	1331326	1878 000 105	1409692	3151 000 651
078867	1878 054 933	1334350	3151 182 233	1440715	1878 080 037
096001	1878 001 070	1342345	1878 054 933	1447243	1878 000 296
096006	1878 001 138	1342345R	1878 054 933	1606333	3483 023 001
113365	3151 000 515	1347218	1878 027 231	160795	1882 137 307
1140537	1878 080 034	1347696	1878 000 105	160795	1882 137 307
1140539	3482 081 231	1347696R	1878 000 105	1614294	1878 080 037
1142188	3151 000 335	1348129	1861 777 037	1615927	3151 000 144
1154221	3151 000 335	1348130	1861 777 043	1623295	1878 003 647
117379	1878 002 706	1348131	1878 044 631	1625963	3400 124 901
117405	3482 118 031	1348132	1878 002 071	1625963R	3400 124 901
117425	3482 006 036	1348133	1878 001 152	1625964	3400 124 701
117425	3482 124 550	1348136	1878 003 657	1625964R	3400 124 701
117875	3482 124 541	1348137	1878 003 657	1625965	3400 700 405
117875	3482 124 541	1348139	1878 003 276	1625965R	3400 700 405
1204205	3482 083 032	1348140	1878 003 269	1625966	3400 121 001
1227302	1862 304 033	1348141	1878 086 741	1625967	3400 121 101
1227303	1888 063 137	1348141	1878 086 741	1625967R	3400 121 101
1230549	3482 018 132	1348142	1878 002 878	1625968	3400 122 101
1230549	3482 119 031	1348142R	1878 002 878	1625968R	3400 122 101
1230550	3482 119 031	1348143	1878 003 269	1625970	3400 125 701
1230550	3482 119 031	1348144	1878 001 071	1625970R	3400 125 701
1230550R	3482 119 031	1348144R	1878 001 071	1625971	3400 700 504
1239659	1878 054 933	1348146R	1878 001 070	1625971R	3400 700 504
1250710	3151 000 034	1362752	3151 000 034	1628626	3400 122 101
1251271	1878 027 231	1362759	1878 054 933	1628627	3400 700 504
1261652	3151 000 395	1375593	1878 000 036	1628627R	3400 700 504
1267988	3151 199 001	1375593R	1878 000 036	1634627	3151 000 144
1272114	3482 119 032	1375595	1878 000 294	165495	1878 001 138
1272115	1878 054 933	1375597	3482 123 839	165497	1878 000 105
1287597	1878 054 933	1376143	1878 027 231	1663218	1878 003 767
1287806	3151 182 233	1380002	1878 000 298	1663220	1878 004 573
1287806	3151 182 233	1380002R	1878 000 298	1663224	1878 003 647
1287898	1878 027 231	1385431	1878 002 071	1664346	3151 000 034
1287898	1878 027 231	1385520	1878 044 631	1664358	3151 000 157
1287898R	1878 027 231	1385520R	1878 044 631	1665428	3482 000 484
1287899	1878 002 878	1385522	1878 054 933	1685707	1878 003 767
1295265	3482 118 031	1385522R	1878 054 933	1685711	1878 004 573
1295265R	3482 118 031	1395695	1878 002 878	1686642	3151 000 493
1303560	1878 054 933	1395695R	1878 002 878	1688219	1878 003 767
1303702	1878 054 951	1395696	1878 054 951	1689108	1878 054 933
1303705	3482 114 032	1395697	1861 777 043	1689109	1878 000 298
1303707	3151 263 031	1395698	1861 777 037	1689145	1878 080 037
1303821	3151 000 395	1395698R	1861 777 037	1689145R	1878 080 037
1303975	3151 000 034	1395699	1878 000 105	1697725	3151 000 493

Vergleichsliste / Cross reference list

Vergleichs-Nr. Compare No.	Artikelnummer Article No.
DAF	
1700507	1878 003 332
1700508R	3482 000 474
1702641	3151 000 397
1703657	1878 005 600
1703657R	1878 005 600
1703658R	3482 000 859
1703739	1878 005 599
1703739R	1878 005 599
1703740	3482 000 474
1703740R	3482 000 474
1703741	1878 005 601
1703741R	1878 005 601
1706758R	1878 004 573
1735708	3482 114 031
1736889	3400 700 353
1736889R	3400 700 353
1736890	3400 700 308
1736890R	3400 700 308
1738830	1878 003 647
1740017	3400 700 307
1740017R	3400 700 307
1746150	3151 000 493
1778732	3400 700 519
1778732R	3400 700 519
1780332	3151 000 034
1787200	3151 000 651
1789280R	3400 122 101
1789281	3400 700 504
1789281R	3400 700 504
1789294R	3400 122 101
1789295R	3400 122 101
1808123R	3400 700 307
1810168	3151 000 034
1813471	1878 054 933
1813471R	1878 054 933
1813472	1878 080 037
1814035	3400 700 361
1814035R	3400 700 361
1815112R	3400 700 307
1815768R	3400 122 101
1815769R	3400 700 504
1815770R	3400 700 519
1816433R	3400 700 520
1816434R	3400 700 521
1816435R	3400 700 467
1816436R	3400 700 368
1817774R	3400 700 307
1817775	3400 700 527
1817775R	3400 700 527
1818190R	3151 000 395
1818190R	3482 123 839
1818191R	1878 004 100
1818191R	3151 000 397
1818191R	3482 000 419
1818192R	3400 700 375
1818193R	3400 700 523
1818194R	3400 700 376
1818195R	3400 700 524
1819446R	3400 700 405
1819447R	3400 700 353
1820661R	3400 700 467

Vergleichs-Nr. Compare No.	Artikelnummer Article No.
DAF	
1820662R	3400 700 489
1822487	3151 000 493
1829488R	3400 700 319
1829974R	1878 054 933
1829974R	3151 000 493
1829974R	3482 083 032
1830316	3151 000 493
1834264R	3400 700 319
1836353R	3400 700 316
1837664R	3400 700 520
1837665R	3400 700 524
1843935	3400 700 398
1843935R	3400 700 398
1843936	3400 700 465
1843936R	3400 700 465
1843937	3400 700 464
1843937R	3400 700 464
1843938	3400 700 473
1843938R	1878 005 599
1843938R	3151 000 651
1843938R	3400 700 473
1843938R	3482 000 474
1843939R	1878 005 599
1843939R	3151 000 395
1843939R	3400 700 476
1843939R	3482 000 474
1846414	1878 004 573
1846414R	1878 004 573
1846416R	1878 003 767
1851348R	3400 122 101
1851349R	3400 700 504
1851350R	3400 700 361
1851351R	3400 122 101
1851352R	3400 700 521
1858217R	1878 001 071
1858217R	3151 199 001
1858217R	3482 060 132
1858560	3482 001 171
1858562	1878 085 742
1858564	3482 001 184
1879929R	1878 079 331
1879929R	3151 000 651
1879929R	3482 000 419
1912687	3151 000 493
1912689	3151 000 034
1916603R	3400 700 353
1935390	3400 122 101
1935392R	3400 700 361
1935394R	3400 700 521
1935396R	3400 700 467
19353963R	3400 122 101
1935397R	3400 700 368
1935399R	3400 700 489
20330517	3482 000 209
20376130	3182 998 501
252683	1878 001 070
259814	1882 110 542
259814	1882 110 542
266060	3151 000 395
274467	1882 304 237
279810	3151 199 001

Vergleichs-Nr. Compare No.	Artikelnummer Article No.
DAF	
281305	1878 086 741
281305	1878 086 741
286877	3482 060 132
286878	1861 777 037
291228	3482 018 132
291228	3482 119 031
295427	1861 777 037
299567	1878 003 269
299568	1878 003 269
331815	1878 001 071
360217	1878 003 657
368100	1878 001 071
373895	1878 001 070
376490	1878 000 105
376491	3482 017 034
378012	1878 001 152
387012	1878 001 152
389380	1878 003 657
500908	1882 110 542
500908	1882 110 542
504039135	3482 123 839
509247	3482 002 234
514454	3151 199 001
514455	3163 030 100
556931	1878 003 269
558111	1878 000 105
558180	1878 086 741
558180	1878 086 741
615808	3163 026 100
615932	3482 017 035
623212	1878 001 070
632743	1878 001 071
633593	3482 008 034
641350	3482 118 031
643540	1882 288 131
644511	1878 634 014
644512	1882 304 237
659078	3482 017 034
659320	3151 199 001
661066	1878 000 105
666432	1878 002 706
669371	1861 923 032
669371	1878 001 152
669372	1878 001 152
679884	3482 119 032
740195	1878 003 657
740528	1878 086 741
740528	1878 086 741
740781	1878 086 741
740781	1878 086 741
740782	1878 003 269
740783	1878 002 706
740784	1878 002 706
740787	1878 003 657
740788	1878 003 657
740789	1878 000 105
740790	1878 000 105
740791	1878 001 152
740792	1878 001 152
740793	1861 777 043
740794	1878 001 070

Vergleichs-Nr. Compare No.	Artikelnummer Article No.
-------------------------------	------------------------------

DAF

740795	1861 777 037
740796	1878 001 071
755079	1878 002 878
890094	1861 777 037
890095	1861 777 043

DEMAG

0890 351	3151 045 001
0890-009	1863 100 030
180 608 40	3151 199 001
182 231 40	3151 045 001
1949 3312	1878 004 832
244 326 40	1882 301 239
3029 114	1880 071 008
3209 031	1863 100 030
334 014	1881 010 139
334 015	3151 045 001
3630-6894-057	1881 010 139
4723-0612	3151 000 493
54184712	3482 000 546
640 513	1863 100 030
650 521	1881 059 208
672 126	1864 634 026
675 015	1863 010 100
678 528	1881 010 139
678 528 40	1881 010 139

DRÖGMÖLLER

000250200001-00	1888 042 009
000250201001-00	1878 000 968
000250201100	1882 301 239
000250202000-00	1878 002 706
000250250100	1878 003 657
000250253100-00	1878 634 016
400250100002-00	3151 000 547
400250100003-00	3488 017 432
400250100003-00	3488 017 432
400250100004-00	1878 005 805
400250100004-00	1878 634 022

ENASA

770 239	3482 124 542
770 240	1878 003 277
770 241	1878 003 276
770 437	3151 145 101
770 568	3482 124 542
770 571	1861 902 032
773 008	1862 208 032
773 008	1878 022 841
774 106	3482 081 231
774 691	3482 081 231
774 692	1878 003 276
774 693	1861 902 032
774106	3482 083 113
775 549	1862 208 032
775 549	1878 022 841
775 550	1878 003 276
775 594	1862 208 032
775 594	1878 022 841
775114	1861 526 046

EVOBUS

000 250 64 15	3151 000 392
---------------	--------------

Vergleichs-Nr. Compare No.	Artikelnummer Article No.
-------------------------------	------------------------------

EVOBUS

000 250 76 15	3151 126 031
002 250 87 04	3482 012 211
004 250 89 04	3482 081 233
005 250 19 04	3482 124 522
007 250 13 03	1878 001 136
007 250 74 03	1878 001 070
019 250 43 03	1878 080 033
019 250 46 03	1878 080 033
020 250 57 03	1878 080 037
023 250 73 03	1878 005 540
023 250 97 03	1878 005 541
8.383.000.133.0	3130 010 100
8.383.000.246	1878 005 486
8.383.000.246.0	1878 005 486
8.383.067.000	1881 041 656
8.383.067.000	1881 041 656
8.383.121.000	1881 039 531
8.383.130.000	1862 088 131
8.383.131.000	3151 021 001
8.383.145.000	1861 410 047
8.383.146.000	1882 301 239
8.383.146.000 C	1882 301 239
8.383.155.000	1882 252 331
8.383.156.000	1861 303 248
8.383.186.000	3151 027 102
8.383.186.000 D	3151 027 102
8.383.186.000.0	3151 027 102
8.383.189.000	3151 000 515
8.383.192.000	1882 302 131
8.383.192.000 C	1882 302 131
8.383.195.000	1861 923 032
8.383.195.000	1878 001 152
8.383.195.000	1878 001 152
8.383.195.000 C	1878 001 152
8.383.203.000	1878 001 152
8.383.210.000	1861 571 110
8.383.211.000	3482 012 211
8.383.211.000	3482 012 211
8.383.211.000 C	3482 012 211
8.383.211.000 C	3482 012 211
8.383.212.000	3151 099 101
8.383.212.000 D	3151 099 101
8.383.212.000.0	3151 099 101
8.383.219.000	1882 342 134
8.383.219.000	1882 342 134
8.383.219.000 C	1882 342 134
8.383.220.000	1861 571 110
8.383.220.000 C	1861 571 110
8.383.224.000	1888 042 009
8.383.224.000 C	1888 042 009
8.383.225.000	1878 000 968
8.383.225.000 D	1878 000 968
8.383.226.185	3151 108 031
8.383.243.000	1861 911 232
8.383.244.000	1882 342 134
8.383.244.000.2	1882 342 134
8.383.248.000	3151 108 031
8.383.254.000	3482 083 113
8.383.254.000 B	3482 081 231
8.383.261.000	1861 571 110
8.383.261.000.0	1861 571 110

Vergleichs-Nr. Compare No.	Artikelnummer Article No.
-------------------------------	------------------------------

EVOBUS

8.383.262.000	1878 000 968
8.383.263.000	1861 911 232
8.383.263.000.0	1861 911 232
8.383.264.000	1888 042 009
8.383.265.000	1878 001 152
8.383.268.000	3482 081 232
8.383.268.000	3482 081 232
8.383.268.000 B	3482 081 232
8.383.269.000	1861 874 032
8.383.271.000	3151 027 133
8.383.275.000	1861 303 248
8.383.276.000	1878 001 070
8.383.280.000.0	3488 017 432
8.383.281.000	1878 005 805
8.383.281.000	1878 634 022
8.383.286.000	1878 080 037
8.383.292.000	3482 083 032
8.383.295.000	1878 085 742
8.383.299.000	1878 085 742
8.383.310.000	1878 085 742
8.383.319.000	3482 081 232
8.383.321.000	1878 080 033
8.383.321.000 C	1878 080 033
8.383.324.000	1878 065 131
8.383.327.000.2	1882 342 135
8.383.328.000	3482 062 035
8.383.330.000	1878 085 641
8.383.330.000	1878 085 641
8.383.333.000	3151 000 615
8.383.333.000.0	3151 000 615
8.383.334.000	3488 017 410
8.383.334.000.2	3488 017 410
8.383.335.000	1878 005 805
8.383.335.000	1878 634 022
8.383.335.000.0	1878 005 805
8.383.335.000.0	1878 634 022
8.383.335.000.0	3488 017 410
8.383.339.000	3482 083 113
8.383.340.000	3482 083 034
8.383.343.000	3482 081 231
8.383.344.000	3482 081 233
8.389.335.000	1878 005 805
8.389.335.000	1878 634 022

FAUN

0890 141	1880 083 132
0890 184	1863 100 030
0890 209	1881 039 532
0890 273	1863 009 100
0890 275	1882 325 134
0890 331	1881 041 656
0890 351	3151 045 001
0890 481	1863 100 030
0890 589	1882 301 239
0890 591	3151 000 375
0890 642	1882 341 001
0890 655	1882 280 213
0890-009	1863 100 030
0890-141	1880 083 132
0890-209	1881 039 532
0890-261	1878 001 074

Vergleichsliste / Cross reference list

Vergleichs-Nr. Compare No.	Artikelnummer Article No.	Vergleichs-Nr. Compare No.	Artikelnummer Article No.	Vergleichs-Nr. Compare No.	Artikelnummer Article No.
FAUN		HINO		IVECO	
0890-269	1880 092 415	38185-EV010	3496 006 000	01266393	1863 100 030
0890-271	1881 041 656	IRISBUS		01266397	1863 009 100
0890-273	1863 009 100	03419028	1863 100 030	01266402	1881 010 139
0890-275	1882 325 134	101652	3151 111 032	01266448	1881 010 139
0890-303	1881 039 532	104671	1866 030 102	01266475	1880 083 132
0890-308	1881 039 532	112320	1862 305 033	01266493	1880 092 415
0890-331	1881 041 656	112447	1878 000 959	01266503	1881 039 532
0890-359	1861 291 136	112590	1878 001 070	01266566	1882 325 134
0890-360	1882 205 234	113099	1878 001 136	01266612	1864 202 035
0890-364	1882 325 139	113795	1878 002 878	01266638	1861 034 147
0890-374	1878 000 104	122531	3482 124 516	01266647	1864 202 035
0890-427	3163 026 100	122739	3482 125 132	01271770	1880 083 132
0890-580	1888 015 515	122744	1888 063 137	01271852	1881 041 656
0890-589	1882 301 239	122745	3482 125 131	01271879	1861 034 147
0890-591	3151 000 375	123102	1862 304 033	01271885	1861 600 033
0890-601	1878 000 967	123165	1878 032 032	01271887	1863 100 030
0890-655	1882 280 213	1271902	1863 101 100	01271895	1863 010 100
0894 009	1863 100 030	151524	1878 634 016	01271897	1861 600 033
3630-6894-057	1881 010 139	154381	3151 208 001	01271900	1863 010 100
3681-0890-184	1863 100 030	2296059	3400 700 497	01271900/U-E	1863 010 100
4100-430	1880 092 415	30196	3151 000 515	01271902/U-E	1863 101 100
8406-404	1878 000 968	42061041	3482 012 238	01271976	1881 041 656
8407-424	3163 026 100	500000874	3151 145 101	01271999	1878 000 104
8407-439	1878 000 968	500001619	1862 438 032	01272016	1881 039 531
8452-295	1882 342 134	500397755	3151 000 144	01272035	1881 039 532
8474-442	1878 002 706	500397756	1878 080 037	01272040	1881 039 532
99707007818	3482 000 209	500697757	3482 083 032	01272042	1881 039 532
99707010805	3151 000 144	5010556020	3482 078 134	01272047	1881 039 532
99707793317	1878 004 832	5010556021	1878 032 032	01272048	1881 039 532
HINO		5010556025	3151 000 157	01272055	1882 325 139
S3121-02600-A	3482 111 031	5010556174	1878 032 032	01272545	1880 092 415
S3125-05010-A	1862 248 033	504034992	3151 000 419	01278622	1882 325 134
S3125-05020-A	1862 543 031	504091142	3151 000 144	01278624	1878 000 104
31001-E01701	1862 543 031	5801203461	1878 000 298	01280179	1880 071 008
31001-E01701	3488 019 133	5801273688	3151 000 157	01415241810	3151 021 001
31001-E0180	3488 019 133	5801312751	6594 000 171	01805282	3151 000 144
31200-1590A	3488 019 133	5801718344	3482 083 040	01903805	1878 600 834
31210-0178A	3151 000 034	77023913	3482 124 542	01903813	1878 634 020
31210-0178A	3482 083 032	775550	1878 003 276	01903813	3482 085 033
31210-2600	3482 111 031	8193332	3100 002 038	01903813	3482 085 033
31210-2600A	3482 111 031	IVECO		01903815	1861 973 032
31210-3200A	3482 083 032	K18036	1863 100 030	01903815	1878 003 661
31217-1130A	3180 001 008	01260096	1878 001 074	01903815	3482 085 033
31230-E0010	3151 000 157	01260402	1864 634 026	01903816	1878 000 957
31230-E0010A	3151 000 157	01260406	1864 202 035	01903816	1882 325 139
31230-E0030	3151 000 034	01260410	1864 347 102	01903817	3482 125 245
31230-E0040	3151 000 750	01260463	1863 837 002	01903818	3482 125 245
31230-0024A	3151 000 157	01260500	1881 039 532	01903819	3482 085 033
31230-1090A	3151 000 750	01260550	1881 009 201	01903820	3482 905 001
31230-1091A	3151 000 750	01260603	1880 083 132	01903821	1862 973 002
31230-1150A	3151 000 034	01260638	1881 039 532	01903821	3482 905 001
31250-E0A80	1878 004 573	01261333	1882 325 134	01903822	3482 125 245
31250-E0850	1878 004 133	01261631	3082 121 031	01903825	1878 600 834
31250-2010A	1862 248 033	01261760	3151 021 001	01903829	1882 806 001
31250-4540	1861 997 137	01261902	1878 000 957	01903830	1850 480 049
31250-4540A	1861 997 137	01262142	1880 092 415	01903830	1862 977 001
31250-5010A	1862 248 033	01262431	1882 325 134	01903830	3000 434 001
31250-5020	1862 543 031	01266374	1863 100 030	01903831	1861 572 431
31250-5020A	1862 543 031	01266388	1859 600 001	01903832	1861 874 032
31250-6480A	1878 080 037	01266392	1863 600 123	01903832	3482 012 238
				01903833	3400 700 454

Vergleichsliste / Cross reference list

Vergleichs-Nr. Compare No.	Artikelnummer Article No.
IVECO	
01903834	3400 700 457
01903835	3400 700 456
01903836	1878 002 955
01903836	3482 085 033
01903837	1861 992 432
01903837	3400 700 454
01903837	3483 010 138
01903838	1878 022 841
01903838	3400 700 457
01903838	3483 010 137
01903841	1862 967 001
01903841	3482 907 001
01903843	3482 038 031
01903844	3482 085 033
01903844	3482 085 033
01903845	1878 002 955
01903845	3482 085 033
01903846	3483 020 034
01903847	1861 653 132
01903847	3482 008 033
01903848	1881 039 532
01903849	1881 039 532
01903850	1878 001 074
01903850	1881 039 532
01903853	1878 634 017
01903853	3482 124 522
01903854	1878 001 070
01903854	1882 307 131
01903855	1878 001 074
01903855	1882 307 131
01903857	1861 479 032
01903858	1881 096 444
01903859	1878 634 017
01903859	3482 124 541
01903860	1878 001 070
01903860	3482 002 234
01903862	1878 002 955
01903865	1878 002 955
01903866	1878 634 017
01903866	3482 124 534
01903867	1878 634 017
01903867	3482 124 534
01903868	3482 124 534
01903870	1878 634 017
01903870	3482 124 541
01903871	1878 001 152
01903871	1882 325 139
01903872	1878 000 957
01903872	1882 325 134
01903873	1878 000 104
01903873	1882 325 134
01903874	1878 000 957
01903874	1882 325 134
01903875	1882 325 134
01903876	1878 001 152
01903876	1882 325 134
01903877	1878 000 957
01903877	1882 325 134
01903878	1882 325 134
01903879	1878 002 955
01903879	3482 124 532

Vergleichs-Nr. Compare No.	Artikelnummer Article No.
IVECO	
01903881	1878 002 955
01903881	3482 124 533
01903882	3482 124 533
01903883	1878 003 657
01903883	3482 124 533
01903884	1878 001 138
01903884	3482 124 532
01903885	1878 003 657
01903885	3482 124 532
01903886	1878 002 955
01903886	1882 316 035
01903886	3482 124 531
01903886	3482 124 531
01903887	1878 001 138
01903887	1882 316 035
01903887	3482 124 531
01903888	1878 003 657
01903888	1882 316 035
01903888	3482 124 531
01903888	3482 124 531
01903890	1861 874 032
01903890	3482 012 211
01903890	3482 012 211
01903891	3400 042 031
01903892	3400 118 901
01903893	1878 002 706
01903893	3482 124 534
01903894	1861 577 136
01903894	3482 008 036
01903896	3482 038 031
01903897	1878 001 077
01903897	3482 002 234
01903899	1878 002 955
01903899	3151 000 515
01903899	3482 124 516
01903900	1878 000 957
01903900	1882 325 139
01903903	3482 008 033
01903907	1862 811 001
01903907	3482 911 001
01903911	1878 002 955
01903911	3482 085 033
01903912	1878 085 742
01903912	3483 020 034
01903913	1850 480 049
01903913	1862 977 001
01903914	3000 434 001
01903916	3400 700 429
01903916	1862 973 002
01903916	3482 905 001
01903920	3400 700 347
01903921	3483 020 034
01903922	3482 125 245
01903923	1861 643 134
01903924	1878 002 955
01903924	3482 085 033
01903924	3482 085 033
01903925	1878 000 957
01903925	1882 325 139
01903927	1861 577 037

Vergleichs-Nr. Compare No.	Artikelnummer Article No.
IVECO	
01903927	3482 008 033
01903928	1861 577 136
01903928	3482 008 036
01903929	1878 634 017
01903929	3482 124 522
01903930	1878 634 017
01903930	3482 124 541
01903931	1878 634 017
01903931	3482 124 534
01903932	1878 634 017
01903932	3482 124 541
01903934	1861 653 132
01903934	3482 008 033
01903935	1861 479 032
01903936	1878 001 138
01903936	1882 316 035
01903936	3151 000 515
01903936	3482 124 531
01903937	1878 001 138
01903937	3482 124 532
01903938	1878 001 138
01903938	3482 124 533
01903939	1878 001 138
01903940	1878 001 138
01903940	3482 124 534
01903941	1878 001 138
01903942	3400 119 001
01903944	1878 022 841
01903944	3483 020 035
01903946	1878 001 152
01903946	1882 325 134
01903947	1878 001 152
01903947	1882 325 139
01903948	1878 001 074
01903948	1881 039 532
01903949	1878 001 074
01903949	1882 307 131
01903950	1861 351 342
01903950	1882 325 134
01903952	1861 351 342
01903952	1882 325 134
01903953	1878 001 070
01903953	1882 307 131
01903954	1878 001 070
01903954	3482 002 234
01903955	1881 039 532
01903956	1878 000 104
01903956	1882 325 134
01903957	1878 001 154
01903957	3482 124 532
01903958	1878 003 657
01903958	3482 124 532
01903959	1878 003 657
01903959	1882 316 035
01903959	3482 124 531
01903959	3482 124 531
01904700	1878 001 154
01904700	1882 316 035
01904700	3482 124 531
01904700	3482 124 531

Vergleichsliste / Cross reference list

Vergleichs-Nr. Compare No.	Artikelnummer Article No.
-------------------------------	------------------------------

IVECO

01904701	1861 742 032
01904701	3482 038 031
01904702	1878 002 706
01904702	3482 124 534
01904703	1878 001 077
01904703	3482 002 234
01904704	1861 874 032
01904704	3482 012 238
01904705	1861 874 032
01904705	3482 012 211
01904705	3482 012 211
01904710	1862 811 001
01904710	3482 911 001
01904711	1878 054 951
01904711	1878 054 951
01904712	3400 700 454
01904713	1878 000 957
01904713	1882 325 134
01904714	1878 000 957
01904714	1882 325 134
01904715	1878 000 957
01904715	1882 325 134
01904716	1878 000 957
01904716	1882 325 134
01904717	1878 000 957
01904717	1882 325 139
01904718	3400 700 429
01904719	1861 742 032
01904719	3482 038 031
01904725	3400 042 031
01904728	1861 973 032
01904728	1878 003 661
01904728	3400 118 901
01904729	1878 085 741
01904729	3483 020 035
01904730	1878 054 951
01904730	1878 054 951
01904730	3483 020 035
01904733	1878 600 834
01904734	1878 600 841
01904734	1882 806 001
01904735	1878 600 841
01904749	1878 002 072
01904749	3083 039 031
01904749	3151 600 529
01904751	1878 085 741
01904751	3482 083 032
01904752	1878 054 951
01904752	1878 054 951
01904752	3482 083 032
01904753	3400 066 031
01904754	3400 700 449
01904755	3400 068 031
01904756	1862 308 031
01904756	3151 000 144
01904756	3482 078 132
01904756	3482 078 134
01904757	1878 634 020
01904758	1861 653 132
01904759	1861 577 037
01904760	3400 117 701

Vergleichs-Nr. Compare No.	Artikelnummer Article No.
-------------------------------	------------------------------

IVECO

01904761	1878 002 955
01904761	3151 207 031
01904761	3482 085 033
01904762	1878 002 955
01904762	3151 207 031
01904762	3400 118 901
01904763	1878 002 955
01904763	3400 042 031
01904764	1861 973 032
01904764	1878 003 661
01904764	3400 118 901
01904769	1878 634 020
01904769	3482 085 033
01904769	3482 085 033
01904770	1878 003 274
01904771	1861 874 032
01904771	3482 012 238
01904772	1861 874 032
01904772	3482 012 211
01904772	3482 012 211
01904773	1861 572 431
01904777	1878 001 154
01904777	3482 085 033
01904777	3482 085 033
01904778	3400 077 071
01904779	1878 054 951
01904779	1878 054 951
01904779	3151 000 144
01904779	3400 700 455
01904779	3482 083 032
01904780	3400 117 801
01904785	1862 317 031
01904785	3151 000 144
01904785	3482 078 134
01904786	3400 700 418
01904787	3400 700 454
01904788	3400 700 457
01904789	3400 700 456
01904790	1878 054 951
01904790	3400 700 454
01904791	1878 634 020
01904791	3482 124 532
01904792	1861 572 431
01904793	3400 042 031
01904794	3000 434 001
01904795	3400 700 429
01904796	1878 032 032
01904796	3151 000 144
01904796	3400 084 031
01904796	3482 078 134
01904797	3151 600 529
01904798	3400 117 701
01905274	3151 600 544
01905282	3151 000 144
01905290	3151 600 529
01905318	3151 065 031
01905465	3151 196 031
01905703	3400 117 801
01905717	3400 700 455
01905728	3400 042 031
01905839	1861 973 032

Vergleichs-Nr. Compare No.	Artikelnummer Article No.
-------------------------------	------------------------------

IVECO

01905839	1878 003 661
01905839	3482 085 033
01905840	1878 054 951
01905840	1878 054 951
01905840	3483 020 034
01908500	3400 700 449
01908502	3400 066 031
01908503	3400 700 449
01908504	3400 700 449
01908508	1878 085 741
01908508	3151 000 144
01908508	3482 083 113
01908509	3400 066 031
01908512	3400 074 031
01908513	3400 107 031
01908514	3400 077 071
01908515	3400 084 031
01908517	3400 700 312
01908518	1878 054 951
01908518	1878 054 951
01908518	3151 000 144
01908518	3482 083 113
01908521	3400 700 429
01908522	3000 434 001
01908523	3400 117 701
01908524	1878 085 741
01908524	3151 000 144
01908524	3482 083 113
01908532	3400 700 455
01908533	3400 117 801
01908534	3400 700 457
01908537	3400 068 031
01908539	3400 077 071
01908540	3400 084 031
01908542	3400 077 071
01908543	3400 700 432
01908544	3400 117 701
01908545	1862 811 001
01908545	3482 911 001
01908548	3400 117 801
01908549	3400 084 031
01908553	3400 700 432
01908558	3400 700 449
01908559	3400 068 031
01908561	3000 951 026
01908574	3400 700 447
02242543	1861 600 033
02337655	3151 021 001
02337656	3151 021 001
02337657	3130 010 100
02419028	1863 100 030
02440918	1863 100 030
02440923	1863 101 100
02442308	1882 325 134
02442309	1881 041 656
02442543	1861 600 033
02442544	1861 600 033
02442545	1880 092 415
02442545/U-E	1880 092 415
02442546	1880 092 415
02442557	1878 000 104

Vergleichsliste / Cross reference list

Vergleichs-Nr. Compare No.	Artikelnummer Article No.
IVECO	
02442558	1878 000 104
02442563	1882 325 134
02443133	3151 000 515
02443133/KZ	3151 000 515
02443712	1861 351 342
02443804	1881 096 444
02474844	1882 261 013
02475334	1878 634 017
02475546	3151 199 001
02475547	3151 199 001
02475629	3151 000 515
02475629/UB	3151 000 515
02476063	3482 060 233
02476073	1882 307 131
02476075	1878 001 074
02476483	3482 124 522
02477136	1878 000 957
02477181	1878 634 017
02477328	1882 307 131
02477896	1878 634 017
02477897	1878 002 955
02477898	1882 325 134
02477900	1878 001 152
02477926	1878 000 957
02477929	1878 000 957
02477930	1878 000 104
02477936	1878 001 074
02478592	1878 001 152
02479048	3151 000 515
02479103	3482 124 534
02479104	3482 124 534
02479854	1861 479 032
02560550	1881 010 139
02565803	3151 199 001
02963850	1881 096 444
02963858	1881 096 444
02963858/U-E	1881 096 444
02963858/U-S	1881 096 444
02984082	3163 026 100
02984082/U-E	3163 026 100
02984096/U-E	1882 280 213
03342363	1863 100 030
03345008	1863 100 030
03415039	1863 100 030
03419028	1863 100 030
03420738/U-E	1805 042 000
03423959	1863 100 030
03435623	1863 010 100
03457374	1881 065 101
03457374/U-S	1881 065 101
03457375	1881 065 101
03457510	1881 065 101
03471490	1881 010 139
03472373	1863 101 100
04370143	1863 837 002
04371490	1881 010 139
04457823	1878 002 955
04459152	3482 124 541
04459728	3482 085 033
04459728	3482 085 033
04459737	3482 002 234

Vergleichs-Nr. Compare No.	Artikelnummer Article No.
IVECO	
04459737/U-S	3482 002 234
04459822	3482 125 131
04459823	1878 002 955
04459827	1861 577 037
04588700	3482 038 031
04607799	1878 600 834
04623109	1878 600 834
04626605	1882 325 134
04641403	1878 600 834
04679105	1878 600 834
04691736	1878 002 955
04692717	3482 125 131
04695659	1882 325 134
04695660	1882 325 134
04695661	1878 000 957
04699157	3151 054 031
04699160	3482 085 033
04699160	3482 085 033
04699161	1878 001 138
04724654	3151 127 031
04725802	3151 071 032
04727742	3151 098 031
04733573	3482 124 532
04733575	3482 124 533
04738961	1878 001 138
04738961	3482 085 033
04738962	3482 085 033
04739151	1878 001 138
04741461	1878 002 955
04741463	3482 085 033
04741464	1878 001 138
04742136	1861 992 432
04742138	3151 123 031
04745051	3482 125 131
04747807	3483 020 034
04749155	3482 125 131
04757082	3151 114 031
04757088	3151 000 148
04757090	3483 020 034
04766074	1882 325 139
04766075	1878 000 957
04769116	1878 000 957
04769156	3151 196 031
04770204	1878 634 020
04770205	3151 117 031
04777541	1862 973 002
04779155	3482 125 131
04787274	3151 196 031
04787275	3151 824 001
04787649	3482 125 245
04787652	3482 125 245
04795778	3482 085 033
04795778/U-S	3482 085 033
04795778/V-E	3482 085 033
04808941	3482 905 001
04811598	3482 125 245
04815846	3482 125 245
04826715	1862 310 132
04834868	1862 973 002
04837884	1878 001 138
04838491	3482 125 131

Vergleichs-Nr. Compare No.	Artikelnummer Article No.
IVECO	
04838491	3482 125 131
04839133	1878 000 957
04846454	3151 196 031
04856715	1862 310 132
04857270	1878 000 957
04859167	1862 973 002
04859168	1861 742 032
04864246	1861 742 032
07137929	3482 125 131
08122735	3151 123 031
08122736	3151 000 148
08132550	1862 308 031
08132554	1878 054 951
08132554	1878 054 951
08193331	3100 002 040
08193332	3100 002 038
08438491	3482 125 131
08558284	1878 600 841
08566182	1878 600 834
08566183	1878 600 834
08566186	1878 600 841
08566309	1850 282 652
08568284	1878 600 841
08582397	1878 600 841
08584017	1882 806 001
08584061	3482 125 245
08584063	3482 125 245
08585082	3151 600 540
08586808	1862 811 001
08586809	3482 911 001
08587332	1862 811 001
08589468	1850 480 049
08597015	1862 811 001
08598464	1862 811 001
08598873	1878 074 841
08600700	1878 600 834
08600701	1878 600 841
08954687	1861 572 431
101652	3151 111 032
112320	1862 305 033
113795	1878 002 878
122531	3482 124 516
122744	1888 063 137
123102	1862 304 033
1271902	1863 101 100
151524	1878 634 016
154381	3151 208 001
1904773	1861 572 431
1905225	3151 204 001
1905469	3151 127 031
1908503	3400 700 449
1908508	3482 083 113
1908518	3482 083 113
1908524	3482 083 113
1908558	3400 700 449
1908559	3400 068 031
20569134	3483 034 042
2991557	3400 042 031
2991558	3400 042 031
2991587	1878 002 955
2991587	3482 124 516

Vergleichsliste / Cross reference list

Vergleichs-Nr. Compare No.	Artikelnummer Article No.	Vergleichs-Nr. Compare No.	Artikelnummer Article No.	Vergleichs-Nr. Compare No.	Artikelnummer Article No.
IVECO					
2991656	3400 700 444	42003325	1861 351 342	42061411	1861 874 032
2992012	3400 700 447	42003364	3482 124 534	42061499	3482 008 038
2992026	3400 700 432	42003365	3482 124 531	42061499/U-S	3482 008 038
2992027	3151 600 529	42003368	3482 124 541	42061519	1882 306 242
2992215	3400 700 432	42003396	3151 199 001	42061545	3482 124 541
2992383	3400 700 330	42003397	3151 199 001	42061547	1878 002 706
2992474	3400 700 433	42003402	1861 653 132	42061852	3151 127 031
2992486	1878 002 825	42003473	3151 000 515	42061853	3151 114 031
2992486	3151 000 144	42003474	3151 000 515	42061921	3151 199 001
2992486	3482 083 113	42003545	1878 001 152	42061941	3483 020 035
2992489	3400 700 452	42003637	1878 001 154	42061964	3483 020 034
2992490	3400 700 430	42003658	3151 000 515	42062093	3482 083 040
2992491	3400 700 431	42003731	1882 325 139	42062095	3151 123 031
2992492	3400 700 431	42003732	1882 325 139	42062097	3151 000 148
2992556	3400 700 447	42003733	1882 325 134	42062098	1878 054 951
2992579	3000 951 026	42003734	1881 041 656	42062098	1878 054 951
2992580	3400 700 432	42003736	1882 325 134	42062099	3483 020 035
2992629	3000 951 026	42003737	1882 325 134	42062100	3483 020 034
2992630	3400 700 432	42003852	3482 124 532	42062100	3483 020 034
2992631	3400 117 701	42006023	1861 653 132	42062100/U-S	3483 020 034
2994017	3400 700 433	42014136	3482 124 533	42062100/V-E	3483 020 034
2994018	3400 700 447	42014136	3482 124 533	42062101	3482 124 516
2994020	3400 700 432	42014240	3482 124 532	42062103	1878 054 951
2994024	3000 951 026	42014248	3482 124 532	42062103	1878 054 951
2994026	3400 117 701	42014319	3482 085 033	42062106	3483 020 034
2994027	3400 700 432	42014319	3482 085 033	42062107	3483 020 035
2994034	3400 117 701	42014399	3482 124 531	42062184	1878 022 841
2994035	3000 951 026	42014718	1878 000 957	42062185	1878 085 741
2994036	3400 700 432	42016023	1861 653 132	42062307	1882 325 139
2994037	3400 700 444	42016352	3482 012 211	42062541	1878 003 657
2994040	3400 700 429	42016352	3482 012 211	42062613	1878 001 138
2994069	3400 700 433	42022205	3151 263 031	42062617	3482 085 033
2994119	3400 700 449	42022206	3482 114 031	42062916	1878 054 951
2995559	3400 700 432	42022207	1878 004 832	42062916	1878 054 951
2995703	3000 951 026	42026023	1861 653 132	42062969	3482 043 134
2995704	3400 700 444	42026271	1882 325 139	42062970	3483 010 138
2995705	3400 700 432	42026352	3482 012 211	42062970/U-E	3483 010 138
2995706	3400 117 701	42026352	3482 012 211	42062971	3483 010 137
2995724	3400 700 483	42026354	3482 012 211	42062971/U-E	3483 010 137
2995776	3400 700 432	42026354	3482 012 211	42062971/V-E	3483 010 137
2995777	3400 700 448	42026354/KZ	3482 012 211	42063032/U-S	1882 302 131
2995815	3400 700 449	42026354/KZ	3482 012 211	42063062	3483 010 138
2996041	3400 700 430	42026355	1861 874 032	42063098	3483 010 137
2996050	3400 700 430	42026470	1878 001 152	42063099	1878 085 741
2996059	3400 700 497	42026780	3482 125 131	42063184	3151 000 515
2996089	3400 700 432	42026898	3151 000 515	42064318	1878 054 951
2996090	3400 700 448	42026899	3151 000 515	42064318	1878 054 951
2996299	3400 700 448	42037017	1878 003 657	42064535	1861 643 134
2996321	3400 700 483	42037018	1878 003 657	42064572	1861 992 432
2996358	3400 700 431	42037235	1861 742 032	42064718	1861 992 432
2996516	3400 700 475	42037237	3482 038 031	42066352	3482 012 211
2996517	3400 700 475	42037449	1878 001 152	42066352	3482 012 211
2996525	3400 700 487	42037450	1878 001 152	42100356	1878 054 951
2996528	3400 700 474	42037963	3482 008 036	42100356	1878 054 951
2996529	3400 700 474	42037964	1861 577 136	42100535	1878 085 741
2996743	3400 117 801	42037967	3482 008 036	42100536	1878 054 951
2996991	3400 700 431	42061041	3482 012 238	42100536	1878 054 951
33/00287	3151 065 031	42061041	3482 012 238	42100537	1878 085 741
33021002	1863 100 030	42061357	1878 001 077	42100538	1861 992 432
42003033	1882 325 134	42061359	3482 002 234	42100566	1861 973 032
42003323	1882 325 139	42061366	3482 124 534	42100566	1878 003 661

Vergleichsliste / Cross reference list

Vergleichs-Nr. Compare No.	Artikelnummer Article No.	Vergleichs-Nr. Compare No.	Artikelnummer Article No.	Vergleichs-Nr. Compare No.	Artikelnummer Article No.
IVECO		IVECO		IVECO	
42100567	1878 002 955	42104821	1862 304 033	500059776	3151 000 144
42100571	1878 002 955	42104821	1862 304 033	500059776	3482 000 572
42100576	1878 002 955	42104983	1878 085 741	500059778	1878 002 825
42100579	1878 085 742	42104991	1862 317 031	500059778	3151 000 144
42101773	1878 022 841	42112970	1862 317 032	500059778	3400 700 461
42101774	1861 992 432	42114018	3482 125 131	500059778	3482 083 113
42101943	3482 125 131	42114181	1878 001 138	500059780	3400 700 378
42101943/U-E	3482 125 131	42114182	1878 002 955	500059788	3400 700 366
42101943/U-S	3482 125 131	42114261	3482 078 132	500292646	1878 054 951
42102091	1878 085 741	42114261	3482 078 134	500301459	1878 085 741
42102093	1878 054 951	42114262	3482 078 134	500301459EZ	1878 085 741
42102093	1878 054 951	42114329	3482 085 033	500305439	3151 000 144
42102095	1878 054 951	42114448	1878 032 032	500317617	3151 000 144
42102095	1878 054 951	42114571	3482 078 134	500317671	3151 000 144
42102097	3482 083 032	42114680	1878 085 741	500317871	1878 032 032
42102099	3482 083 032	42114756	3482 078 134	500324215	1878 002 072
42102103	3151 000 144	42114856	3151 000 144	500335045	3400 074 031
42102104	1878 054 951	42159124	1861 777 037	500335046	3400 074 031
42102104	1878 054 951	42159124	1861 777 041	500335050	3400 107 031
42102145	1861 479 032	42489672	3151 032 341	500335051	3400 107 031
42102146	1861 577 136	42532400	3482 124 531	500335052	3400 107 031
42102146	1861 577 136	42532401	3482 124 541	500335056	3400 077 071
42102147	1861 577 037	42532403	3482 124 532	500335057	3400 077 071
42102148	1861 653 132	42532404	3482 124 534	500335062	3400 084 031
42102149	1861 600 033	42532405	3482 124 533	500335063	3400 084 031
42102150	1861 577 136	42532406	3482 124 550	500335064	3400 084 031
42102151	1861 874 032	42532407	3482 124 542	500335067	3400 084 031
42102151/U-E	1861 874 032	42532408	3482 124 516	500335068	3151 000 144
42102151/V-E	1861 874 032	42532409	3482 085 033	500335096	3400 700 313
42102151/V-S	1861 874 032	42532410	3482 125 132	500335098	3400 700 312
42102152	1878 001 077	42532411	3482 125 131	500335101	3400 700 312
42102152/U-E	1878 001 077	42535597	3483 023 001	500335105	3400 117 801
42102153	1861 742 032	42536129	3483 023 003	500335106	3400 117 801
42102154	1878 001 074	42536130	3483 023 003	500335107	3400 117 801
42102155	1878 001 070	42536131	3483 023 003	500358237	1878 000 611
42102157	1861 742 032	42536464	1878 051 801	500358239	1862 310 132
42102160	1878 001 152	42543362	3151 000 144	500358295	3400 074 031
42102161	1861 351 342	42548067	1878 054 951	500365787	3400 700 430
42102163	1878 000 104	42556650	3151 000 144	500370064	3400 700 452
42102167	1862 308 031	4699160	3482 085 033	500370077	3400 700 431
42102168	1862 317 031	4725802	3151 071 032	500370082	3400 700 431
42102169	1878 003 274	4727742	3151 098 031	500370084	3400 700 452
42102171	1878 001 154	4770205	3151 117 031	500370316	3400 700 452
42102172	1861 643 134	500000874	3151 145 101	500371281	3400 117 801
42102172	1861 643 134	500001619	1862 438 032	500371282	3400 117 801
42102173	1878 002 706	500001619	1862 438 032	500371283	3400 117 801
42102175	1878 634 017	5000305439	3151 000 144	500372079	1878 085 741
42102177	1878 085 741	500059740	3400 042 031	500372081	1878 085 741
42102316	3151 207 031	500059758	3400 700 487	500372083	1878 085 741
42102413	1878 001 138	500059762	3400 084 031	500375057	1878 004 133
42102942	3482 083 113	500059764	3400 700 312	500376219	3400 117 801
42102947	3482 083 032	500059766	3400 117 801	500392642	3400 700 455
42102970	1862 317 032	500059768	1878 003 767	500392643	3400 700 455
42103036	3400 117 801	500059768	3151 000 144	500392645	1878 054 951
42103321	1862 317 031	500059768	3482 083 032	500392646	1878 054 951
42104476	3151 000 144	500059770	1878 004 133	500392648	1878 054 951
42104648	3482 078 134	500059770	3151 000 144	500392654	3400 700 455
42104649	1862 317 032	500059770	3482 083 032	500392828	3400 107 031
42104709	1861 874 032	500059772	3400 700 377	500392839	3400 084 031
42104793	1878 085 741	500059774	3400 700 378	500392840	3400 084 031
42104820	1888 063 137	500059776	1878 004 132	500392841	3400 084 031

Vergleichsliste / Cross reference list

Vergleichs-Nr. Compare No.	Artikelnummer Article No.
-------------------------------	------------------------------

IVECO

500392843	3400 084 031
500392868	1878 032 032
500392872	1878 032 032
500397755	3151 000 144
5006172148	3151 250 231
500697757	3482 083 032
5010244421	1878 001 145
503138923	3151 000 493
50317871	1878 032 032
504004160	3400 117 801
504018317	1878 085 741
504029031	1878 002 825
504034992	3151 000 419
504034993	1878 000 036
504039135	1878 000 036
504039135	3151 000 419
50403994	3482 123 839
50404993	1878 000 036
504059764	3400 700 433
504061486	3400 700 433
504064953	3400 117 801
504064954	1878 085 741
504068259	1878 085 741
504068261	3400 117 801
504068265	3400 117 801
504073840	1878 002 072
504080319	3400 700 433
504084401	6594 000 054
504100901	6594 000 120
504101334	3400 700 514
504118531	3400 700 515
504120865	3151 000 144
504122591	3400 700 432
504130776	3400 700 430
504147553	3400 700 430
504148900	3400 700 377
504148901	1878 004 133
504148901	3151 000 144
504148901	3400 700 378
504148901	3482 000 573
504148902	3400 700 378
504148904	3400 700 462
504148905	3400 700 461
504148906	3400 700 461
504149340	1878 004 581
504149343	1878 004 133
504149351	1878 004 132
504149354	1878 004 132
504149357	3482 000 628
504149359	3482 000 572
504149361	3151 000 651
504158912	3151 000 144
504171014	3482 000 573
504197817	1878 004 133
504213752	3482 000 474
504213753	3151 000 515
504213792	3482 000 474
504221984	3400 700 378
504221985	3400 700 462
504222037	1878 004 133
504222042	3151 000 144

Vergleichs-Nr. Compare No.	Artikelnummer Article No.
-------------------------------	------------------------------

IVECO

504225011	3400 700 461
504225016	1878 004 132
504225034	1878 004 133
504225038	3400 700 378
504229168	3482 000 419
504229179	3151 000 515
504229188	3151 000 515
504229574	1878 004 133
504237890	3400 700 365
504237892	3400 700 366
504237895	3151 000 493
504241882	6594 000 054
504256058	1878 004 133
504256059	1878 004 132
504262566	3400 700 514
504262569	3400 700 515
504264336	3400 700 378
504285997	3400 700 365
504286000	3400 700 366
504294640	3151 000 651
504336615	1878 003 767
504336617	1878 085 741
504336621	1878 004 133
504385079	3151 000 144
504385080	3151 000 493
504389742	3482 000 419
504389743	3482 001 172
5107520104	1881 010 139
5107520180	3151 045 001
5145520310	1863 100 030
5148520210	1863 100 030
5157520282	1863 100 030
51575202910	1863 101 100
5177521851	1863 010 100
5801550547	1878 032 032
5801555056	3400 700 436
5801555058	1878 004 100
5801558431	1878 004 581
5801626185	3400 700 606
5801626186	3400 700 608
5801639884	1878 007 250
5801689822	3482 001 174
5801702427	6594 000 211
5801712140	1878 004 132
5801718344	3482 083 040
5801720105	1878 054 933
5801729653	3400 700 607
5801729658	1878 079 306
5801738722	1878 004 133
61146202	1850 480 049
61146225	3482 038 031
61146230	1850 480 049
61146808	1882 325 134
61146802	1882 307 131
61146805	1881 039 532
61146812	3482 085 033
61146812	3482 085 033
61146815	3482 085 033
61146818	3482 124 531
61146822	3482 124 533
61146825	3482 085 033

Vergleichs-Nr. Compare No.	Artikelnummer Article No.
-------------------------------	------------------------------

IVECO

61146834	3482 124 534
61146842	3483 020 034
61146844	3483 010 138
61146846	3483 010 137
61146848	3483 020 035
61146850	3482 125 245
61146852	3482 125 245
61146862	3483 020 034
61146864	3482 085 033
61146866	3483 010 138
61146868	3483 010 137
61146870	3483 020 035
61147596	1864 509 041
6140-16-03.10	1881 065 101
6141-16-04.10	1881 065 101
6141-16-04.10	1881 065 101
61573540	3482 042 041
61606904	3482 905 001
61671355	3482 042 041
61674595	3482 042 041
61751945	1882 325 134
624516	1878 003 277
632100420	3151 000 515
7138962	3482 000 953
7138962	3482 051 131
7138964	3151 000 374
77019180	3482 042 041
77019500	3482 042 041
77023913	3482 124 542
77028180	1850 480 049
77028185	1862 977 001
77040185	1878 600 834
77097010	1878 600 841
77097510	1878 600 841
77414510	1878 600 834
77414520	1878 600 834
775549	1862 208 032
775549	1878 022 841
775550	1878 003 276
775551	1861 902 032
81584007	3482 038 031
81705961	1878 600 841
85000266	3483 034 042
86021252	3482 008 033
86021253	3482 008 033
86021255	3482 038 031
86021261	1861 577 136
8739-44-01.05	1863 100 030
8739-44-01.20	1863 100 030
8739-44-01.50	1863 009 100
8739-44-02.11	1805 042 000
8739-44-02.50	1859 600 001
8739-44-05.10	1863 600 123
8739-44-05.20	1863 100 030
8739-44-05.30	1863 010 100
8739-44-05.60	1863 009 100
8739-44-07.10	1863 100 030
8739-47-06.40	1881 010 139
8739-47-07.10	1880 083 132
8739-47-08.10	1880 083 132
8739-47-10.30	1880 092 415

Vergleichsliste / Cross reference list

Vergleichs-Nr. Compare No.	Artikelnummer Article No.
IVECO	
8739-47-13.10	1881 039 532
8739-47-21.10	1882 325 134
8739-47-24.10	1881 065 101
8739-47-27.10	1880 071 008
8739-47-50.30	1864 202 035
8739-47-50.310	1861 034 147
8739-47-50.45	1864 202 035
8751-52-01.30	1880 083 132
8751-52-11.03	1861 034 147
8751-52-11.35	1861 034 147
8751-52-12.04	1861 600 033
8751-52-12.23	1863 101 100
8751-52-51.35	1878 001 074
8751-52-51.36	1881 039 532
8751-52-51.55	1878 001 074
8751-52-51.64	1881 039 532
8751-52-51.65	1881 039 532
8751-52-51.92	1882 325 134
93160284	3151 032 341
93160482	1862 039 015
93161755	3496 006 000
93161931	3496 006 000
93162073	3496 006 000
93800282	3151 065 031
93800287	3151 065 031
93801198	1862 977 001
93801199	1850 480 049
93801297	3482 907 001
93801299	1862 967 001
93806524	1862 977 001
93806525	1850 480 049
93806822	3151 065 031
93807195	1862 977 001
93807441	1862 977 001
93808387	3151 065 031
93808506	1850 480 049
93808507	1862 967 001
93808508	3482 907 001
93808930	3482 907 001
93809013	3482 907 001
93811556	1862 967 001
93811557	1862 977 001
93812451	3482 998 701
93812486	3083 039 031
93812487	1878 002 072
93812488	3151 600 529
93812489	3083 039 031
93812506	3151 600 529
93812507	1878 997 101
93812508	3482 998 701
93812511	3083 039 031
94459823	1878 002 955
96062916	1878 054 951
96062916	1878 054 951
98400175	3151 600 544
98400707	1878 000 611
98400708	3482 094 031
98400713	3482 094 031
98400715	3151 600 544
98400717	1878 000 611
98400721	3151 600 544

Vergleichs-Nr. Compare No.	Artikelnummer Article No.
IVECO	
98400724	1862 310 132
98400725	3482 093 031
98400726	3482 093 031
98400727	1862 310 132
98401893	1878 074 841
98401894	3400 066 031
98401896	3482 092 031
98402393	3151 600 544
98403096	3482 092 031
98406605	1862 308 031
98406607	1862 310 132
98417693	1878 000 611
98419240	1878 074 841
98434871	3151 600 544
98435802	1878 054 951
98435802	1878 054 951
98435804	1878 085 741
98435975	1878 054 951
98435975	1878 054 951
98435977	1878 085 741
98436139	1878 032 032
98436141	1878 032 032
98436159	1862 317 032
98436188	3151 000 144
98448583	1878 997 101
98453282	3483 020 034
98453284	3483 020 034
98460675	1878 002 072
98469384	1878 000 611
98469386	1878 000 611
98471635	3000 951 026
98471641	3400 117 701
98471686	1878 002 072
98471689	1878 002 072
98471692	1878 997 101
98481323	1878 074 841
98481325	1878 074 841
98481328	1878 074 841
98481328	1878 074 841
98484662	1861 992 432
98484664	1878 085 741
98486125	3400 700 449
98486127	3400 700 449
98490360	1878 074 841
98495987	1862 308 031
98495997	1862 317 031
98495998	1862 317 032
98496005	1878 054 951
98496005	1878 054 951
98496006	1878 085 741
98496859	1878 074 841
98496861	1878 000 611
98499254	1862 317 032
98499256	1878 032 032
99430261	1862 308 031
99430262	1862 317 031
99430263	1862 317 032
99430265	1878 032 032
99434788	1862 310 132
99445713	1878 085 741
99445716	1878 054 951

Vergleichs-Nr. Compare No.	Artikelnummer Article No.
IVECO	
99445716	1878 054 951
99449837	3482 078 134
99453752	1878 085 741
99453753	1878 054 951
99453753	1878 054 951
99463434	1878 054 951
99463435	1878 085 741
99473296	3482 998 701
KÄSSBOHRER	
000 250 63 04	1882 201 132
003 250 88 04	3482 124 522
003 250 98 04	3482 008 038
005 250 19 04	3482 124 522
005 250 90 04	1882 342 134
017 250 87 03	1878 080 034
8.383.000.133.0	3130 010 100
8.383.000.246	1878 005 486
8.383.000.246.0	1878 005 486
8.383.022.000	1882 110 532
8.383.067.000	1881 041 656
8.383.067.000	1881 041 656
8.383.121.000	1881 039 531
8.383.130.000	1862 088 131
8.383.130.000	1862 088 131
8.383.131.000	3151 021 001
8.383.145.000	1861 410 047
8.383.146.000	1882 301 239
8.383.146.000 C	1882 301 239
8.383.155.000	1882 252 331
8.383.156.000	1861 303 248
8.383.186.000	3151 027 102
8.383.186.000 D	3151 027 102
8.383.189.000	3151 000 515
8.383.192.000	1882 302 131
8.383.192.000 C	1882 302 131
8.383.195.000	1861 923 032
8.383.195.000	1878 001 152
8.383.195.000	1878 001 152
8.383.195.000 C	1878 001 152
8.383.203.000	1878 001 152
8.383.210.000	1861 571 110
8.383.211.000	3482 012 211
8.383.211.000	3482 012 211
8.383.211.000 C	3482 012 211
8.383.212.000	3151 099 101
8.383.212.000 D	3151 099 101
8.383.219.000	1882 342 134
8.383.219.000	1882 342 134
8.383.219.000 C	1882 342 134
8.383.220.000	1861 571 110
8.383.220.000 C	1861 571 110
8.383.224.000	1888 042 009
8.383.224.000 C	1888 042 009
8.383.225.000	1878 000 968
8.383.225.000 D	1878 000 968
8.383.226.185	3151 108 031
8.383.234.000	3482 006 036
8.383.243.000	1861 911 232
8.383.244.000	1882 342 134
8.383.248.000	3151 108 031

Vergleichsliste / Cross reference list

Vergleichs-Nr. Compare No.	Artikelnummer Article No.
KÄSSBOHRER	
8.383.254.000	3482 083 113
8.383.254.000 B	3482 081 231
8.383.261.000	1861 571 110
8.383.262.000	1878 000 968
8.383.263.000	1861 911 232
8.383.263.000.0	1861 911 232
8.383.263.000.2	1861 911 232
8.383.264.000	1888 042 009
8.383.265.000	1878 001 152
8.383.265.000.2	1878 001 152
8.383.267.000	1878 005 668
8.383.268.000	3482 081 232
8.383.268.000	3482 081 232
8.383.268.000 B	3482 081 232
8.383.269.000	1861 874 032
8.383.271.000	3151 027 133
8.383.275.000	1861 303 248
8.383.275.000.0	1861 303 248
8.383.276.000	1878 001 070
8.383.280.000	3488 017 432
8.383.280.000.0	3488 017 432
8.383.281.000	1878 005 805
8.383.281.000	1878 634 022
8.383.282.000	3151 000 547
8.383.282.000 C	3151 000 547
8.383.286.000	1878 080 037
8.383.292.000	3482 083 032
8.383.292.000	3482 083 032
8.383.292.000 B	3482 083 032
8.383.295.000	1878 085 742
8.383.299.000	1878 085 742
8.383.310.000	1878 085 742
8.383.318.000	3482 083 032
8.383.319.000	3482 081 232
8.383.321.000	1878 080 033
8.383.321.000 C	1878 080 033
8.383.324.000	1878 065 131
8.383.327.000	1882 342 135
8.383.327.000.2	1882 342 135
8.383.328.000	3482 062 035
8.383.330.000	1878 085 641
8.383.330.000	1878 085 641
8.383.333.000	3151 000 615
8.383.334.000	3488 017 410
8.383.334.000.2	3488 017 410
8.383.335.000	1878 005 805
8.383.335.000	1878 634 022
8.383.335.000.2	1878 005 805
8.383.335.000.2	1878 634 022
8.383.336.000	1878 080 034
8.383.336.000	1878 080 034
8.383.336.000 C	1878 080 034
8.383.336.000 C	1878 080 034
8.383.339.000	3482 083 113
8.383.340.000	3482 083 034
8.383.343.000	3482 081 231
8.383.344.000	3482 081 233
8.383.350.000	1878 080 034
8.383.350.000	1878 080 034
8.389.335.000	1878 005 805
8.389.335.000	1878 634 022

Vergleichs-Nr. Compare No.	Artikelnummer Article No.
LIEBHERR	
1000-3465	1866 157 101
1001-6633	1866 000 007
1001-6872	1866 157 103
1002-2829	1866 000 021
1010-0069	1866 000 062
1011-6024	1866 000 151
1013-6818	1866 000 007
1022-1026	1866 000 152
1022-8100	1866 000 079
1028-8617	1878 004 832
1033-2556	3482 000 546
1049-2338	3151 000 493
5001-041	1863 100 030
5006-801	1866 136 001
5007-636	1866 138 101
5009-663	1866 156 001
5030-103	1881 010 139
5030-103	3151 045 001
5030-105	1878 000 105
5030-105	1882 302 131
5030-106	1881 010 139
5030-107	1878 000 967
5030-109	1882 234 433
5030-114	1881 010 139
5030-166	1878 000 967
5030-166	3151 000 515
5030-25408	3488 017 447
5031-005	1864 202 035
5031-040	1863 100 030
5031-100	1880 083 132
5031-118	1881 010 139
5031-18308	3482 083 118
5031-18408	3151 000 034
5031-18708	3482 000 209
5031-18808	3482 000 246
5031-301	1881 010 139
5031-316	1882 166 737
5031-316	1882 166 737
5031-317	1878 000 104
5031-319	1878 000 964
5031-32608	3151 208 001
5031-32608	3151 208 001
5031-32708	1861 224 005
5031-328	1881 010 139
5031-32808	1881 010 139
5031-329	3151 045 001
5031-32908	3151 045 001
5031-333	1878 000 967
5031-33308	1878 000 967
5031-335	1878 000 105
5031-33508	1878 000 105
5031-336	1882 302 131
5031-33608	1882 302 131
5031-338	1881 010 139
5031-34208	1878 001 070
5031-343	1878 000 961
5031-35208	1878 002 437
5031-403	1881 010 139
5602-880	1866 065 001
5603-810	1866 090 001
5607-974	1866 133 001

Vergleichs-Nr. Compare No.	Artikelnummer Article No.
LIEBHERR	
5608-138	1866 135 001
5608-851	1866 148 001
5611-081	1866 148 001
MAGIRUS-DEUTZ	
K 18036	1863 100 030
0126 0096	1878 001 074
0126 0500	1881 039 532
0126 0603	1880 083 132
0126 0638	1881 039 532
0126 1333	1882 325 134
0126 1902	1878 000 957
0126 2431	1882 325 134
0126 6374	1863 100 030
0126 6393	1863 100 030
0126 6448	1881 010 139
0126 6475	1880 083 132
0126 6503	1881 039 532
0126 6566	1882 325 134
0126 6638	1861 034 147
0127 1770	1880 083 132
0127 1770 /U-E	1880 083 132
0127 1852	1881 041 656
0127 1879	1861 034 147
0127 1885	1861 600 033
0127 1887	1863 100 030
0127 1897	1861 600 033
0127 1900 /U-E	1863 010 100
0127 1902 /U-E	1863 101 100
0127 1976	1881 041 656
0127 1999	1878 000 104
0127 2035	1881 039 532
0127 2040	1881 039 532
0127 2042	1881 039 532
0127 2047	1881 039 532
0127 2047 /U-E	1881 039 532
0127 2048	1881 039 532
0127 8622	1882 325 134
0127 8624	1878 000 104
0190 3816	1878 000 957
0190 3836	1878 002 955
0190 3837	1861 992 432
0190 3838	1878 022 841
0190 3843	3482 038 031
0190 3845	1878 002 955
0190 3846	3483 020 034
0190 3847	1861 653 132
0190 3847	3482 008 033
0190 3848	1881 039 532
0190 3849	1881 039 532
0190 3850	1878 001 074
0190 3850	1881 039 532
0190 3853	1878 634 017
0190 3853	3482 124 522
0190 3854	1878 001 070
0190 3854	1882 307 131
0190 3855	1878 001 074
0190 3855	1882 307 131
0190 3857	1861 479 032
0190 3858	1881 096 444
0190 3859	1878 634 017

Vergleichsliste / Cross reference list

Vergleichs-Nr. Compare No.	Artikelnummer Article No.
-------------------------------	------------------------------

MAGIRUS-DEUTZ

0190 3859	3482 124 541
0190 3860	1878 001 070
0190 3860	3482 002 234
0190 3862	1878 002 955
0190 3865	1878 002 955
0190 3866	1878 634 017
0190 3866	3482 124 534
0190 3867	1878 634 017
0190 3867	3482 124 534
0190 3868	3482 124 534
0190 3870	1878 634 017
0190 3870	3482 124 541
0190 3871	1878 001 152
0190 3872	1878 000 957
0190 3873	1878 000 104
0190 3873	1882 325 134
0190 3874	1878 000 957
0190 3874	1882 325 134
0190 3875	1882 325 134
0190 3876	1878 001 152
0190 3876	1882 325 134
0190 3877	1878 000 957
0190 3877	1882 325 134
0190 3878	1882 325 134
0190 3879	1878 002 955
0190 3879	3482 124 532
0190 3881	1878 002 955
0190 3881	3482 124 533
0190 3882	3482 124 533
0190 3883	1878 003 657
0190 3883	3482 124 533
0190 3884	1878 001 138
0190 3885	1878 003 657
0190 3886	1878 002 955
0190 3886	1882 316 035
0190 3886	3482 124 531
0190 3886	3482 124 531
0190 3887	1878 001 138
0190 3887	1882 316 035
0190 3887	3482 124 531
0190 3887	3482 124 531
0190 3888	1878 003 657
0190 3888	1882 316 035
0190 3888	3482 124 531
0190 3888	3482 124 531
0190 3890	3482 012 211
0190 3890	3482 012 211
0190 3891	3400 042 031
0190 3893	1878 002 706
0190 3893	3482 124 534
0190 3894	1861 577 136
0190 3894	3482 008 036
0190 3896	3482 038 031
0190 3897	1878 001 077
0190 3897	3482 002 234
0190 3900	1878 000 957
0190 3903	3482 008 033
0190 3911	1878 002 955
0190 3912	3483 020 034
0190 3921	3483 020 034
0190 3924	1878 002 955

Vergleichs-Nr. Compare No.	Artikelnummer Article No.
-------------------------------	------------------------------

MAGIRUS-DEUTZ

0190 3925	1878 000 957
0190 3927	1861 577 037
0190 3927	3482 008 033
0190 3928	1861 577 136
0190 3928	3482 008 036
0190 3929	1878 634 017
0190 3929	3482 124 522
0190 3930	1878 634 017
0190 3930	3482 124 541
0190 3931	1878 634 017
0190 3931	3482 124 534
0190 3932	1878 634 017
0190 3932	3482 124 541
0190 3934	1861 653 132
0190 3934	3482 008 033
0190 3935	1861 479 032
0190 3936	1878 001 138
0190 3936	1882 316 035
0190 3936	3482 124 531
0190 3936	3482 124 531
0190 3937	1878 001 138
0190 3938	1878 001 138
0190 3938	3482 124 533
0190 3939	1878 001 138
0190 3940	1878 001 138
0190 3940	3482 124 534
0190 3941	1878 001 138
0190 3944	1878 022 841
0190 3944	3483 020 035
0190 3946	1878 001 152
0190 3946	1882 325 134
0190 3947	1878 001 152
0190 3948	1878 001 074
0190 3948	1881 039 532
0190 3949	1878 001 074
0190 3949	1882 307 131
0190 3950	1861 351 342
0190 3950	1882 325 134
0190 3952	1861 351 342
0190 3952	1882 325 134
0190 3953	1878 001 070
0190 3953	1882 307 131
0190 3954	1878 001 070
0190 3954	3482 002 234
0190 3955	1881 039 532
0190 3956	1878 000 104
0190 3956	1882 325 134
0190 3957	1878 001 154
0190 3957	3482 124 532
0190 3958	1878 003 657
0190 3959	1878 003 657
0190 3959	1882 316 035
0190 3959	3482 124 531
0190 3959	3482 124 531
0190 4700	1878 001 154
0190 4700	1882 316 035
0190 4700	3482 124 531
0190 4700	3482 124 531
0190 4701	1861 742 032
0190 4701	3482 038 031
0190 4702	1878 002 706

Vergleichs-Nr. Compare No.	Artikelnummer Article No.
-------------------------------	------------------------------

MAGIRUS-DEUTZ

0190 4702	3482 124 534
0190 4703	1878 001 077
0190 4703	3482 002 234
0190 4705	3482 012 211
0190 4705	3482 012 211
0190 4713	1878 000 957
0190 4713	1882 325 134
0190 4714	1878 000 957
0190 4715	1878 000 957
0190 4715	1882 325 134
0190 4716	1878 000 957
0190 4716	1882 325 134
0190 4717	1878 000 957
0190 4719	3482 038 031
0190 4725	3400 042 031
0190 4729	3483 020 035
0190 4730	3483 020 035
0190 4734	1878 600 841
0190 4735	1878 600 841
0190 4758	1861 653 132
0190 4759	1861 577 037
0190 4761	1878 002 955
0190 4762	1878 002 955
0190 4763	1878 002 955
0190 4763	3400 042 031
0190 4772	3482 012 211
0190 4772	3482 012 211
0190 4777	1878 001 154
0190 4790	3483 020 035
0190 4791	3482 124 532
0190 4793	3400 042 031
0190 5728	3400 042 031
0190 5840	3483 020 034
0224 2543	1861 600 033
0241 9028	1863 100 030
0244 0918	1863 100 030
0244 0923	1863 101 100
0244 2309	1881 041 656
0244 2543	1861 600 033
0244 2544	1861 600 033
0244 2545 /U-E	1880 092 415
0244 2557	1878 000 104
0244 2558	1878 000 104
0244 3133	3151 000 515
0244 3712	1861 351 342
0244 3804	1881 096 444
0247 4844	1882 261 013
0247 5334	1878 634 017
0247 5546	3151 199 001
0247 5547	3151 199 001
0247 5629	3151 000 515
0247 6063	3482 060 233
0247 6073	1882 307 131
0247 6075	1878 001 074
0247 6483	3482 124 522
0247 7136	1878 000 957
0247 7181	1878 634 017
0247 7328	1882 307 131
0247 7896	1878 634 017
0247 7897	1878 002 955
0247 7898	1882 325 134

Vergleichsliste / Cross reference list

Vergleichs-Nr. Compare No.	Artikelnummer Article No.
-------------------------------	------------------------------

MAGIRUS-DEUTZ

0247 7926	1878 000 957
0247 7929	1878 000 957
0247 7930	1878 000 104
0247 7936	1878 001 074
0247 8592	1878 001 152
0247 9048	3151 000 515
0247 9103	3482 124 534
0247 9104	3482 124 534
0247 9854	1861 479 032
0256 0550	1881 010 139
0256 5803	3151 199 001
0296 3850	1881 096 444
0296 3858	1881 096 444
0296 3858 /U-E	1881 096 444
0298 4082 /U-E	3163 026 100
0334 2363	1863 100 030
0334 5008	1863 100 030
0341 5039	1863 100 030
0341 9028	1863 100 030
0342 3959	1863 100 030
0343 5623	1863 010 100
0345 7374 /U-S	1881 065 101
0345 7510 /U-E	1881 065 101
0345 7510 /U-E	1881 065 101
0347 1490	1881 010 139
0347 1490 /U-E	1881 010 139
0347 2373	1863 101 100
0437 1490	1881 010 139
0445 7823	1878 002 955
0445 9152	3482 124 541
0445 9737	3482 002 234
0445 9822	3482 125 131
0445 9823	1878 002 955
0445 9827	1861 577 037
0458 8700	3482 038 031
0462 6605	1882 325 134
0469 1736	1878 002 955
0469 2717	3482 125 131
0469 5659	1882 325 134
0469 5660	1882 325 134
0469 5660 /U-E	1882 325 134
0469 5661	1878 000 957
0469 9161	1878 001 138
0472 4654	3151 127 031
0472 5802	3151 071 032
0472 7742	3151 098 031
0473 3573	3482 124 532
0473 3575	3482 124 533
0473 8961	1878 001 138
0473 9151	1878 001 138
0474 1461	1878 002 955
0474 1464	1878 001 138
0474 2136	1861 992 432
0474 2138	3151 123 031
0474 5051	3482 125 131
0474 7807	3483 020 034
0474 9155	3482 125 131
0475 7088	3151 000 148
0475 7090	3483 020 034
0476 6075	1878 000 957
0476 9116	1878 000 957

Vergleichs-Nr. Compare No.	Artikelnummer Article No.
-------------------------------	------------------------------

MAGIRUS-DEUTZ

0477 9155	3482 125 131
0483 7884	1878 001 138
0483 8491	3482 125 131
0483 9133	1878 000 957
0485 7270	1878 000 957
0713 7929	3482 125 131
0812 2735	3151 123 031
0812 2736	3151 000 148
0819 3331	3100 002 040
0819 3332	3100 002 038
0843 8491	3482 125 131
0855 8284	1878 600 841
0856 6186	1878 600 841
0856 6309	1850 282 652
0856 8284	1878 600 841
0858 2397	1878 600 841
0860 0701	1878 600 841
2991 558	3400 042 031
3302 1002	1863 100 030
4200 3033	1882 325 134
4200 3325	1861 351 342
4200 3364	3482 124 534
4200 3364 /U-E	1882 301 239
4200 3364 /U-E	3482 124 534
4200 3364 /U-S	1882 301 239
4200 3364 /U-S	3482 124 534
4200 3365	3482 124 531
4200 3368	3482 124 541
4200 3368 /U-E	3482 124 541
4200 3396	3151 199 001
4200 3397	3151 199 001
4200 3402	1861 653 132
4200 3473	3151 000 515
4200 3473 /U-E	3151 000 515
4200 3473 /U-S	3151 000 515
4200 3474	3151 000 515
4200 3545	1878 001 152
4200 3637	1878 001 154
4200 3658	3151 000 515
4200 3734	1881 041 656
4200 3734 /U-E	1881 041 656
4200 3736	1882 325 134
4200 3736 /U-E	1882 325 134
4200 3736 /U-S	1882 325 134
4200 3737	1882 325 134
4200 3737 /U-E	1882 325 134
4200 3737 /U-S	1882 325 134
4200 3852	3482 124 532
4200 3852 /U-E	3482 124 532
4200 3852 /U-S	3482 124 532
4200 6023	1861 653 132
4201 4136	3482 124 533
4201 4240	3482 124 532
4201 4248 /U-E	3482 124 532
4201 4399	3482 124 531
4201 4399 /U-E	1882 316 035
4201 4399 /U-E	3482 124 531
4201 4399 /U-S	1882 316 035
4201 4399 /U-S	3482 124 531
4201 4718	1878 000 957
4201 6023	1861 653 132

Vergleichs-Nr. Compare No.	Artikelnummer Article No.
-------------------------------	------------------------------

MAGIRUS-DEUTZ

4201 6352	3482 012 211
4201 6352	3482 012 211
4202 6023	1861 653 132
4202 6352	3482 012 211
4202 6352	3482 012 211
4202 6354	3482 012 211
4202 6354	3482 012 211
4202 6354 KZ	3482 012 211
4202 6354 KZ	3482 012 211
4202 6355	1861 874 032
4202 6470	1878 001 152
4202 6780	3482 125 131
4202 6898	3151 000 515
4202 6899	3151 000 515
4203 7017	1878 003 657
4203 7018	1878 003 657
4203 7235	1861 742 032
4203 7237	3482 038 031
4203 7449	1878 001 152
4203 7450	1878 001 152
4203 7963	3482 008 036
4203 7963 /U-E	3482 008 036
4203 7963 /U-S	3482 008 036
4203 7964	1861 577 136
4203 7967	3482 008 036
4206 1357	1878 001 077
4206 1359	3482 002 234
4206 1366	3482 124 534
4206 1499 /U-S	3482 008 038
4206 1519	1882 306 242
4206 1545	3482 124 541
4206 1545 /U-E	1882 301 238
4206 1545 /U-E	3482 124 541
4206 1545 /U-S	1882 301 238
4206 1545 /U-S	3482 124 541
4206 1547	1878 002 706
4206 1852	3151 127 031
4206 1921	3151 199 001
4206 1941	3483 020 035
4206 1964	3483 020 034
4206 2095	3151 123 031
4206 2097	3151 000 148
4206 2099	3483 020 035
4206 2100	3483 020 034
4206 2100 /U-E	3483 020 034
4206 2106	3483 020 034
4206 2107	3483 020 035
4206 2184	1878 022 841
4206 2307 /U-E	1882 325 139
4206 2307 /U-S	1882 325 139
4206 2541	1878 003 657
4206 2613	1878 001 138
4206 3184	3151 000 515
4206 4572	1861 992 432
4206 4718	1861 992 432
4206 6352	3482 012 211
4206 6352	3482 012 211
4210 0538	1861 992 432
4210 0567	1878 002 955
4210 0571	1878 002 955
4210 0576	1878 002 955

Vergleichs-Nr. Compare No.	Artikelnummer Article No.
-------------------------------	------------------------------

MAGIRUS-DEUTZ

4210 1773	1878 022 841
4210 1774	1861 992 432
4210 1943	3482 125 131
4210 2145	1861 479 032
4210 2146	1861 577 136
4210 2147	1861 577 037
4210 2148	1861 653 132
4210 2149	1861 600 033
4210 2150	1861 577 136
4210 2152	1878 001 077
4210 2153	1861 742 032
4210 2154	1878 001 074
4210 2155	1878 001 070
4210 2157	1861 742 032
4210 2160	1878 001 152
4210 2161	1861 351 342
4210 2163	1878 000 104
4210 2171	1878 001 154
4210 2173	1878 002 706
4210 2175	1878 634 017
4210 2413	1878 001 138
4211 4018	3482 125 131
4211 4181	1878 001 138
4211 4182	1878 002 955
4248 3478 /U-E	1866 030 102
4253 2400	3482 124 531
4253 2401	3482 124 541
4253 2403	3482 124 532
4253 2404	3482 124 534
4253 2405	3482 124 533
4253 2411	3482 125 131
5107-52-01.04	1881 010 139
5107-52-01.80	3151 045 001
5145-52-03.10	1863 100 030
5148-52-02.10	1863 100 030
5157-52-02.82	1863 100 030
5157-52-02.910	1863 101 100
5177-52-18.51	1863 010 100
6114 6225	3482 038 031
6114 6808	1882 325 134
6114 6802	1882 307 131
6114 6805	1881 039 532
6114 6818	3482 124 531
6114 6822	3482 124 533
6114 6834	3482 124 534
6114 6842	3483 020 034
6114 6848	3483 020 035
6114 6862	3483 020 034
6114 6870	3483 020 035
6175 1945	1882 325 134
7709 7010	1878 600 841
7709 7510	1878 600 841
8158 4007	3482 038 031
8170 5961	1878 600 841
8602 1252	3482 008 033
8602 1252 /U-E	3482 008 033
8602 1252 /U-S	3482 008 033
8602 1253	3482 008 033
8602 1255	3482 038 031
8602 1261	1861 577 136
8739-44-01.05	1863 100 030

Vergleichs-Nr. Compare No.	Artikelnummer Article No.
-------------------------------	------------------------------

MAGIRUS-DEUTZ

8739-44-01.20	1863 100 030
8739-44-05.20	1863 100 030
8739-44-05.30	1863 010 100
8739-47-06.40	1881 010 139
8739-47-07.10	1880 083 132
8739-47-08.10	1880 083 132
8739-47-13.10	1881 039 532
8739-47-21.10	1882 325 134
8739-47-50.310	1861 034 147
8751-52-01.30	1880 083 132
8751-52-11.03	1861 034 147
8751-52-11.35	1861 034 147
8751-52-12.04	1861 600 033
8751-52-51.35	1878 001 074
8751-52-51.36	1881 039 532
8751-52-51.55	1878 001 074
8751-52-51.64	1881 039 532
8751-52-51.65	1881 039 532
8751-52-51.92	1882 325 134
9316 0482	1862 039 015
9380 0287 /U-E	3151 065 031
9445 9823	1878 002 955
9845 3282	3483 020 034
9845 3284	3483 020 034
9848 4662	1861 992 432
MAN	
VA.30000.9434	3400 122 201
VA.30000.9866	3400 127 401
VA.30000.9876	3400 700 402
32.30305.0027	3482 000 819
36.30301.0003	1878 085 742
36.30550.0001	3151 000 144
36.30550.0003	3151 000 157
50.12210.20	6482 000 216
51.02301.6044	6594 000 124
51.02301.6086	6594 000 121
51.02301.9044	6594 000 124
51.02301.9086	6594 000 121
51.93410.0029	1863 869 028
51.93410.0143	1863 869 038
51.93410.0149	1863 869 042
64.30500.001	3151 000 151
81.30000.6336	1878 001 144
81.30000.6336	1878 001 147
81.30000.6336	1882 209 335
81.30000.6336	3151 000 958
81.30000.6532	3400 121 701
81.30000.6557	3400 121 901
81.30000.6572	3400 700 404
81.30000.6577	3400 700 402
81.30000.6579	3400 700 403
81.30000.6581	3400 127 401
81.30000.6582	3400 127 401
81.30000.6587	1878 080 031
81.30000.6587	3151 000 034
81.30000.6587	3482 083 032
81.30000.6592	3400 700 404
81.30000.6593	3400 700 402
81.30000.6600	1878 080 031
81.30000.6600	3151 000 034

Vergleichs-Nr. Compare No.	Artikelnummer Article No.
-------------------------------	------------------------------

MAN

81.30000.6600	3482 083 032
81.30000.6601	1878 080 033
81.30000.6601	3482 083 032
81.30000.6602	1878 080 034
81.30000.6602	3482 083 032
81.30000.6606	3400 700 403
81.30000.6616	1878 002 643
81.30000.6616	3151 262 031
81.30000.6616	3488 017 447
81.30000.6617	3400 127 401
81.30000.6620	3400 700 460
81.30000.6621	3400 700 402
81.30000.6628	3400 700 403
81.30000.6630	3400 127 401
81.30000.6634	3400 700 402
81.30000.6635	3400 700 460
81.30000.6640	3400 700 506
81.30000.6641	3400 700 512
81.30000.6642	3400 700 511
81.30000.6650	3400 127 401
81.30000.6653	3400 127 401
81.30000.6654	3400 127 401
81.30000.6657	3400 700 403
81.30000.6673	3400 127 401
81.30000.7220	1878 002 643
81.30000.7220	3151 262 031
81.30000.7220	3488 017 447
81.30000.9336	1878 001 144
81.30000.9336	1878 001 147
81.30005.0005	3400 700 412
81.30005.9001	3400 125 801
81.30005.9003	3400 710 001
81.30005.9005	3400 700 412
81.30005.9006	3400 121 701
81.30005.9007	3400 127 601
81.30005.9008	3400 127 601
81.30005.9009	3400 127 601
81.30005.9010	3400 127 601
81.30005.9012	3400 122 201
81.30005.9013	3400 122 201
81.30005.9016	3400 122 301
81.30005.9018	3400 122 201
81.30005.9019	3400 700 327
81.30005.9020	3400 122 201
81.30005.9021	3400 122 201
81.30005.9022	3400 127 401
81.30005.9023	3400 700 380
81.30005.9024	3400 710 002
81.30005.9025	3400 710 003
81.30005.9026	3400 700 402
81.30005.9028	3400 127 401
81.30005.9029	3400 122 201
81.30005.9032	3400 700 381
81.30005.9033	3400 700 459
81.30005.9035	3400 700 507
81.30005.9036	3400 700 460
81.30005.9037	3400 700 380
81.30005.9038	3400 700 460
81.30005.9039	3400 710 011
81.30050.9034	3400 700 380
81.30300.6002	3496 006 000

Vergleichsliste / Cross reference list

Vergleichs-Nr. Compare No.	Artikelnummer Article No.
-------------------------------	------------------------------

MAN

81.30300.6003	3496 006 000
81.30301.0001	1878 044 631
81.30301.0031	1861 034 147
81.30301.0038	1861 206 211
81.30301.0046	1861 034 147
81.30301.0059	1861 470 234
81.30301.0060	1861 206 211
81.30301.0064	1878 001 155
81.30301.0088	1878 000 104
81.30301.0097	1878 005 367
81.30301.0099	1878 005 367
81.30301.0104	1878 001 152
81.30301.0106	1878 001 155
81.30301.0111	1878 001 144
81.30301.0111	1878 001 147
81.30301.0114	1878 000 967
81.30301.0116	1878 001 154
81.30301.0117	1878 001 152
81.30301.0121	1878 000 964
81.30301.0126	1861 526 046
81.30301.0126	1878 002 955
81.30301.0128	1878 001 144
81.30301.0128	1878 001 147
81.30301.0134	1878 000 105
81.30301.0135	1878 001 079
81.30301.0149	1878 001 152
81.30301.0150	1878 000 964
81.30301.0151	1878 000 967
81.30301.0152	1878 001 144
81.30301.0152	1878 001 147
81.30301.0153	1878 001 079
81.30301.0155	1878 000 104
81.30301.0161	1878 001 071
81.30301.0163	1878 001 152
81.30301.0166	1878 000 967
81.30301.0169	1878 000 964
81.30301.0170	1861 841 132
81.30301.0171	1861 841 132
81.30301.0176	1862 219 031
81.30301.0180	1878 001 152
81.30301.0181	1861 749 132
81.30301.0182	1861 749 132
81.30301.0183	1861 748 132
81.30301.0187	1861 206 211
81.30301.0191	1861 911 232
81.30301.0192	1861 911 232
81.30301.0193	1862 219 031
81.30301.0194	1861 841 132
81.30301.0201	1861 911 232
81.30301.0203	1861 777 037
81.30301.0203	1861 777 041
81.30301.0206	1861 876 134
81.30301.0208	1861 911 232
81.30301.0212	1861 777 037
81.30301.0212	1861 777 041
81.30301.0213	1878 002 706
81.30301.0217	1878 004 832
81.30301.0218	1878 004 832
81.30301.0219	1878 004 832
81.30301.0220	1878 004 832
81.30301.0222	1878 004 832

Vergleichs-Nr. Compare No.	Artikelnummer Article No.
-------------------------------	------------------------------

MAN

81.30301.0223	1878 004 832
81.30301.0224	1878 004 832
81.30301.0225	1878 004 832
81.30301.0228	1878 001 152
81.30301.0229	1878 001 152
81.30301.0230	1878 001 152
81.30301.0231	1878 001 152
81.30301.0232	1861 911 232
81.30301.0234	1878 000 965
81.30301.0235	1878 000 968
81.30301.0238	1862 364 133
81.30301.0238	1862 364 133
81.30301.0239	1862 364 133
81.30301.0239	1862 364 133
81.30301.0240	1862 364 133
81.30301.0240	1862 364 133
81.30301.0241	1862 364 133
81.30301.0241	1862 364 133
81.30301.0242	1862 364 031
81.30301.0243	1862 364 031
81.30301.0244	1862 364 031
81.30301.0245	1862 364 031
81.30301.0246	1861 911 232
81.30301.0247	1878 001 144
81.30301.0247	1878 001 147
81.30301.0248	1878 001 152
81.30301.0250	1861 911 232
81.30301.0252	1861 841 132
81.30301.0253	1862 219 031
81.30301.0254	1878 086 941
81.30301.0256	1878 004 832
81.30301.0257	1878 004 832
81.30301.0258	1878 004 832
81.30301.0260	1861 841 132
81.30301.0261	1862 219 031
81.30301.0262	1862 219 031
81.30301.0263	1878 000 964
81.30301.0264	1861 748 132
81.30301.0265	1861 526 046
81.30301.0265	1878 002 955
81.30301.0266	1861 749 132
81.30301.0270	1861 876 134
81.30301.0273	1862 244 032
81.30301.0274	1862 244 032
81.30301.0275	1862 244 032
81.30301.0277	1878 001 077
81.30301.0278	1878 001 077
81.30301.0279	1878 001 077
81.30301.0280	1878 001 077
81.30301.0283	1878 000 957
81.30301.0284	1878 000 957
81.30301.0285	1878 000 957
81.30301.0287	1861 577 037
81.30301.0287	1861 577 037
81.30301.0288	1861 777 037
81.30301.0288	1861 777 041
81.30301.0289	1878 004 832
81.30301.0290	1878 001 154
81.30301.0291	1878 002 706
81.30301.0292	1878 086 741
81.30301.0292	1878 086 741

Vergleichs-Nr. Compare No.	Artikelnummer Article No.
-------------------------------	------------------------------

MAN

81.30301.0293	1878 001 144
81.30301.0293	1878 001 147
81.30301.0294	1861 777 037
81.30301.0294	1861 777 041
81.30301.0295	1862 364 133
81.30301.0295	1862 364 133
81.30301.0299	1862 303 031
81.30301.0300	1862 302 031
81.30301.0304	1861 034 147
81.30301.0305	1878 001 155
81.30301.0306	1878 005 367
81.30301.0307	1878 001 079
81.30301.0308	1878 000 964
81.30301.0309	1878 000 967
81.30301.0310	1878 001 071
81.30301.0313	1878 000 965
81.30301.0314	1878 000 968
81.30301.0316	1878 086 941
81.30301.0317	1878 086 941
81.30301.0318	1862 364 133
81.30301.0318	1862 364 133
81.30301.0319	1862 364 133
81.30301.0319	1862 364 133
81.30301.0320	1862 364 133
81.30301.0320	1862 364 133
81.30301.0322	1878 004 832
81.30301.0323	1878 004 832
81.30301.0325	1878 004 832
81.30301.0326	1878 004 832
81.30301.0327	1878 004 832
81.30301.0328	1862 364 031
81.30301.0329	1862 364 031
81.30301.0337	1878 000 964
81.30301.0339	1878 001 079
81.30301.0340	1861 600 033
81.30301.0342	1878 001 154
81.30301.0343	1878 002 706
81.30301.0344	1878 086 741
81.30301.0344	1878 086 741
81.30301.0346	1862 364 031
81.30301.0347	1862 364 133
81.30301.0350	1862 438 032
81.30301.0351	1862 364 133
81.30301.0351	1862 364 133
81.30301.0353	1878 080 031
81.30301.0354	1878 085 641
81.30301.0354	1878 085 641
81.30301.0355	1862 441 131
81.30301.0355	1862 441 131
81.30301.0355	1878 080 034
81.30301.0358	1878 061 841
81.30301.0360	1878 004 832
81.30301.0364	1862 441 131
81.30301.0364	1878 080 034
81.30301.0366	1878 004 832
81.30301.0371	1862 364 133
81.30301.0372	1861 841 132
81.30301.0374	1878 003 657
81.30301.0375	1878 001 145
81.30301.0376	1862 441 131
81.30301.0376	1878 080 034

Vergleichsliste / Cross reference list

Vergleichs-Nr. Compare No.	Artikelnummer Article No.
-------------------------------	------------------------------

MAN

81.30301.0377	1878 080 031
81.30301.0378	1862 506 131
81.30301.0380	1862 438 032
81.30301.0381	1862 441 131
81.30301.0381	1878 080 034
81.30301.0382	1862 441 131
81.30301.0382	1878 080 034
81.30301.0383	1878 004 832
81.30301.0385	1862 441 131
81.30301.0385	1878 080 034
81.30301.0386	1862 441 131
81.30301.0386	1878 080 034
81.30301.0388	1862 441 131
81.30301.0388	1878 080 034
81.30301.0390	1878 004 832
81.30301.0391	1878 004 832
81.30301.0392	1878 002 643
81.30301.0393	1878 044 631
81.30301.0393	1878 044 631
81.30301.0395	1878 044 631
81.30301.0395	1878 044 631
81.30301.0407	1878 004 832
81.30301.0408	1878 004 832
81.30301.0411	1878 079 331
81.30301.0413	1878 080 033
81.30301.0416	1878 002 139
81.30301.0419	1878 004 832
81.30301.0420	1878 080 037
81.30301.0421	1878 080 033
81.30301.0421	1878 080 033
81.30301.0433	1862 506 131
81.30301.0434	1878 002 139
81.30301.0438	1878 080 031
81.30301.0440	1878 080 034
81.30301.0444	1878 051 801
81.30301.0445	1878 002 139
81.30301.0446	1878 002 139
81.30301.0448	1878 002 139
81.30301.0450	1878 079 331
81.30301.0455	1878 000 650
81.30301.0456	1878 080 031
81.30301.0456	1878 080 031
81.30301.0457	1878 080 031
81.30301.0458	1878 080 033
81.30301.0459	1878 080 034
81.30301.0460	1878 080 037
81.30301.0460	1878 080 037
81.30301.0461	1878 001 145
81.30301.0463	1878 080 031
81.30301.0464	1878 004 832
81.30301.0465	1878 080 037
81.30301.0466	1878 002 139
81.30301.0468	1878 079 331
81.30301.0469	1878 079 331
81.30301.0470	1878 079 331
81.30301.0473	1878 002 139
81.30301.0474	1878 000 841
81.30301.0475	1878 044 631
81.30301.0476	1878 080 037
81.30301.0478	1878 002 139
81.30301.0480	1862 506 131

Vergleichs-Nr. Compare No.	Artikelnummer Article No.
-------------------------------	------------------------------

MAN

81.30301.0481	1862 506 131
81.30301.0488	1878 002 139
81.30301.0490	1878 079 331
81.30301.0491	1878 079 331
81.30301.0492	1878 079 331
81.30301.0497	1878 080 031
81.30301.0498	1878 080 031
81.30301.0499	1878 080 033
81.30301.0500	1878 080 034
81.30301.0501	1878 004 832
81.30301.0502	1878 004 832
81.30301.0503	1878 080 037
81.30301.0504	1878 634 027
81.30301.0505	1878 634 027
81.30301.0506	1878 080 037
81.30301.0507	1878 080 037
81.30301.0508	1878 002 139
81.30301.0509	1878 080 034
81.30301.0511	1878 634 027
81.30301.0513	1878 004 832
81.30301.0514	1878 080 037
81.30301.0516	1862 506 131
81.30301.0520	1878 079 331
81.30301.0522	1878 002 139
81.30301.0524	1862 506 131
81.30301.0525	1878 002 139
81.30301.0526	1878 002 139
81.30301.0526	1878 002 139
81.30301.0527	1878 002 139
81.30301.0529	1878 079 331
81.30301.0530	1878 002 139
81.30301.0531	1878 002 139
81.30301.0533	1878 080 037
81.30301.0534	1878 080 037
81.30301.0538	1878 002 139
81.30301.0539	1878 002 643
81.30301.0545	1878 080 037
81.30301.0546	1878 080 037
81.30301.0547	1878 080 037
81.30301.0547	1878 080 037
81.30301.0548	1878 080 037
81.30301.0549	1878 080 037
81.30301.0556	1878 079 331
81.30301.0557	1862 506 131
81.30301.0558	1862 506 131
81.30301.0559	1878 080 037
81.30301.0560	1878 004 104
81.30301.0564	1878 004 104
81.30301.0566	1878 002 643
81.30301.0567	1878 080 037
81.30301.0569	1878 004 832
81.30301.0574	1878 004 832
81.30301.0575	1878 002 139
81.30301.0578	1878 004 832
81.30301.0579	1878 080 033
81.30301.0580	1878 006 713
81.30301.0582	1878 080 034
81.30301.0583	1878 080 034
81.30301.0588	1878 004 832
81.30301.0589	1878 002 643
81.30301.0590	1878 004 104

Vergleichs-Nr. Compare No.	Artikelnummer Article No.
-------------------------------	------------------------------

MAN

81.30301.0591	1878 004 104
81.30301.0593	1878 004 104
81.30301.0595	1878 004 540
81.30301.0596	1878 004 540
81.30301.0598	1878 004 540
81.30301.0601	1862 506 131
81.30301.0611	1878 004 540
81.30301.0612	1878 004 540
81.30301.0613	1878 004 540
81.30301.0615	1862 506 131
81.30301.0617	1878 004 104
81.30301.0622	1878 004 832
81.30301.0623	1878 080 037
81.30301.0624	1878 080 033
81.30301.0626	1878 080 037
81.30301.0627	1878 004 832
81.30301.0628	1878 004 832
81.30301.0630	1878 004 104
81.30301.0632	1878 004 104
81.30301.0634	1878 004 104
81.30301.0636	1878 080 037
81.30301.0647	1878 004 540
81.30301.0648	1878 004 540
81.30301.0664	1878 001 145
81.30301.0665	1878 004 540
81.30301.0666	1878 004 540
81.30301.0671	1878 007 126
81.30301.0992	1878 086 741
81.30301.0992	1878 086 741
81.30301.1001	1861 876 134
81.30301.1002	1878 001 152
81.30301.1008	1878 000 964
81.30301.4485	1878 080 033
81.30301.6007	1878 005 367
81.30301.6012	1878 005 367
81.30301.6099	1878 004 832
81.30301.9001	1861 876 134
81.30301.9002	1878 001 152
81.30301.9007	1878 005 367
81.30301.9008	1878 000 964
81.30301.9012	1878 005 367
81.30301.9031	1861 034 147
81.30301.9038	1861 206 211
81.30301.9046	1861 034 147
81.30301.9059	1861 470 234
81.30301.9060	1861 206 211
81.30301.9064	1878 001 155
81.30301.9088	1878 000 104
81.30301.9097	1878 005 367
81.30301.9099	1878 005 367
81.30301.9104	1878 001 152
81.30301.9106	1878 001 155
81.30301.9110	1878 001 155
81.30301.9111	1878 001 144
81.30301.9111	1878 001 147
81.30301.9114	1878 000 967
81.30301.9116	1878 001 154
81.30301.9117	1878 001 152
81.30301.9121	1878 000 964
81.30301.9126	1861 526 046
81.30301.9126	1878 002 955

Vergleichsliste / Cross reference list

Vergleichs-Nr. Compare No.	Artikelnummer Article No.
-------------------------------	------------------------------

MAN

81.30301.9128	1878 001 144
81.30301.9128	1878 001 147
81.30301.9134	1878 000 105
81.30301.9135	1878 001 079
81.30301.9149	1878 001 152
81.30301.9150	1878 000 964
81.30301.9151	1878 000 967
81.30301.9152	1878 001 144
81.30301.9152	1878 001 147
81.30301.9153	1878 001 079
81.30301.9155	1878 000 104
81.30301.9161	1878 001 071
81.30301.9163	1878 001 152
81.30301.9166	1878 000 967
81.30301.9166	3482 083 113
81.30301.9169	1878 000 964
81.30301.9170	1861 841 132
81.30301.9171	1861 841 132
81.30301.9180	1878 001 152
81.30301.9181	1861 749 132
81.30301.9182	1861 749 132
81.30301.9183	1861 748 132
81.30301.9187	1861 206 211
81.30301.9191	1861 911 232
81.30301.9192	1861 911 232
81.30301.9194	1861 841 132
81.30301.9201	1861 911 232
81.30301.9203	1861 777 037
81.30301.9203	1861 777 041
81.30301.9206	1861 876 134
81.30301.9208	1861 911 232
81.30301.9212	1861 777 037
81.30301.9212	1861 777 041
81.30301.9213	1878 002 706
81.30301.9228	1878 001 152
81.30301.9229	1878 001 152
81.30301.9230	1878 001 152
81.30301.9231	1878 001 152
81.30301.9232	1861 911 232
81.30301.9234	1878 000 965
81.30301.9235	1878 000 968
81.30301.9246	1861 911 232
81.30301.9248	1878 001 152
81.30301.9250	1861 911 232
81.30301.9252	1861 841 132
81.30301.9260	1861 841 132
81.30301.9261	1862 219 031
81.30301.9263	1878 000 964
81.30301.9264	1861 748 132
81.30301.9265	1861 526 046
81.30301.9265	1878 002 955
81.30301.9266	1861 749 132
81.30301.9270	1861 876 134
81.30301.9274	1862 244 032
81.30301.9275	1862 244 032
81.30301.9284	1878 000 957
81.30301.9287	1861 577 037
81.30301.9288	1861 777 037
81.30301.9288	1861 777 041
81.30301.9290	1878 001 154
81.30301.9291	1878 002 706

Vergleichs-Nr. Compare No.	Artikelnummer Article No.
-------------------------------	------------------------------

MAN

81.30301.9292	1878 086 741
81.30301.9293	1878 001 144
81.30301.9293	1878 001 147
81.30301.9294	1861 777 037
81.30301.9294	1861 777 041
81.30301.9304	1861 034 147
81.30301.9306	1878 005 367
81.30301.9307	1878 001 079
81.30301.9308	1878 000 964
81.30301.9309	1878 000 967
81.30301.9310	1878 001 071
81.30301.9312	1878 000 967
81.30301.9322	1878 004 832
81.30301.9325	1878 004 832
81.30301.9327	1878 004 832
81.30301.9329	1862 364 031
81.30301.9337	1878 000 964
81.30301.9339	1878 001 079
81.30301.9340	1861 600 033
81.30301.9342	1878 001 154
81.30301.9343	1878 002 706
81.30301.9344	1878 086 741
81.30301.9346	1862 364 031
81.30301.9351	1862 364 133
81.30301.9358	1878 061 841
81.30301.9360	1878 004 832
81.30301.9377	1878 080 031
81.30301.9378	1862 506 131
81.30301.9381	1862 441 131
81.30301.9381	1878 080 034
81.30301.9386	1862 441 131
81.30301.9386	1878 080 034
81.30301.9392	1878 002 643
81.30301.9393	1878 044 631
81.30301.9393	1878 044 631
81.30301.9413	1878 080 033
81.30301.9438	1878 080 031
81.30301.9457	1878 080 031
81.30301.9458	1878 080 033
81.30301.9465	1878 080 037
81.30301.9473	1878 002 139
81.30301.9476	1878 080 037
81.30301.9492	1878 079 331
81.30301.9499	1878 080 033
81.30301.9506	1878 080 037
81.30301.9513	1878 004 832
81.30301.9514	1878 080 037
81.30301.9516	1862 506 131
81.30301.9525	1878 002 139
81.30301.9533	1878 080 037
81.30301.9534	1878 080 037
81.30301.9547	1878 080 037
81.30301.9548	1878 080 037
81.30301.9549	1878 080 037
81.30301.9557	1862 506 131
81.30301.9566	1878 002 643
81.30301.9567	1878 080 037
81.30301.9569	1878 004 832
81.30301.9575	1878 002 139
81.30301.9579	1878 080 033
81.30301.9617	1878 004 104

Vergleichs-Nr. Compare No.	Artikelnummer Article No.
-------------------------------	------------------------------

MAN

81.30301.9627	1878 004 832
81.30301.9671	1878 007 126
81.30301.9992	1878 086 741
81.30302.0002	1859 212 000
81.30302.9002	1859 212 000
81.30305.0007	1880 083 132
81.30305.0022	1880 092 415
81.30305.0023	1882 110 542
81.30305.0029	1882 261 013
81.30305.0046	1882 302 131
81.30305.0048	3482 124 534
81.30305.0050	1888 015 523
81.30305.0053	1882 302 131
81.30305.0056	1882 209 335
81.30305.0060	1881 039 531
81.30305.0062	3482 006 036
81.30305.0062	3482 124 550
81.30305.0064	1880 092 415
81.30305.0068	3482 006 036
81.30305.0068	3482 124 550
81.30305.0075	1888 015 523
81.30305.0078	3482 124 534
81.30305.0079	1882 302 131
81.30305.0080	1881 041 656
81.30305.0081	1882 110 542
81.30305.0083	1882 330 032
81.30305.0083	3482 124 541
81.30305.0084	1882 301 239
81.30305.0084	3482 124 534
81.30305.0084	3482 124 534
81.30305.0090	3482 060 233
81.30305.0098	3482 032 331
81.30305.0099	3482 032 331
81.30305.0104	3482 102 031
81.30305.0108	1882 280 213
81.30305.0109	3482 006 036
81.30305.0109	3482 006 036
81.30305.0109	3482 124 550
81.30305.0111	3482 124 522
81.30305.0112	3482 008 110
81.30305.0113	1882 342 134
81.30305.0114	1882 304 237
81.30305.0114	1882 304 237
81.30305.0117	1882 342 134
81.30305.0120	3482 017 033
81.30305.0121	3482 060 233
81.30305.0123	1882 346 131
81.30305.0124	1882 342 134
81.30305.0137	1882 342 135
81.30305.0137	3482 124 549
81.30305.0138	3482 083 032
81.30305.0139	3482 083 032
81.30305.0145	3482 006 036
81.30305.0145	3482 124 550
81.30305.0146	1859 212 001
81.30305.0155	3482 078 133
81.30305.0157	1882 017 131
81.30305.0158	3482 083 032
81.30305.0160	3482 102 031
81.30305.0161	3482 008 141
81.30305.0162	3482 060 132

Vergleichsliste / Cross reference list

Vergleichs-Nr. Compare No.	Artikelnummer Article No.
-------------------------------	------------------------------

MAN

81.30305.0163	3482 017 035
81.30305.0164	1888 015 346
81.30305.0165	3482 083 032
81.30305.0166	3482 083 113
81.30305.0170	1882 017 131
81.30305.0170	1882 017 131
81.30305.0172	3482 085 034
81.30305.0176	3488 017 333
81.30305.0178	3482 078 133
81.30305.0179	3482 083 032
81.30305.0180	3482 017 034
81.30305.0182	3482 083 032
81.30305.0183	3483 023 001
81.30305.0184	3482 093 032
81.30305.0186	3482 102 031
81.30305.0186	3482 102 031
81.30305.0187	3482 102 031
81.30305.0189	3482 062 035
81.30305.0190	3482 086 132
81.30305.0191	3482 083 032
81.30305.0191	3482 083 032
81.30305.0192	3488 017 333
81.30305.0193	3482 083 032
81.30305.0194	3482 083 032
81.30305.0197	3482 114 031
81.30305.0198	3482 000 467
81.30305.0200	3488 017 447
81.30305.0201	3482 120 031
81.30305.0202	3483 023 003
81.30305.0206	3482 000 461
81.30305.0209	3482 000 461
81.30305.0210	3483 023 001
81.30305.0211	3482 124 534
81.30305.0213	3482 000 361
81.30305.0215	1888 015 346
81.30305.0218	3482 000 361
81.30305.0220	3482 000 361
81.30305.0221	3482 000 246
81.30305.0222	3482 000 209
81.30305.0223	3482 000 464
81.30305.0224	3482 000 461
81.30305.0225	3482 000 467
81.30305.0226	3482 114 031
81.30305.0227	3482 000 546
81.30305.0228	3488 017 447
81.30305.0229	3482 000 246
81.30305.0230	3482 000 361
81.30305.0231	3488 017 447
81.30305.0232	3482 000 461
81.30305.0233	3482 000 467
81.30305.0234	3482 000 546
81.30305.0235	3482 000 664
81.30305.0236	3482 000 679
81.30305.0239	3482 000 246
81.30305.0243	3482 001 180
81.30305.0246	3482 001 145
81.30305.6007	1880 083 132
81.30305.6011	1882 302 131
81.30305.6014	3482 124 534
81.30305.6024	1882 330 032
81.30305.6024	3482 124 541

Vergleichs-Nr. Compare No.	Artikelnummer Article No.
-------------------------------	------------------------------

MAN

81.30305.6028	3482 124 534
81.30305.6053	1888 015 346
81.30305.9007	1880 083 132
81.30305.9046	1882 302 131
81.30305.9048	3482 124 534
81.30305.9050	1888 015 523
81.30305.9053	1882 302 131
81.30305.9056	1882 209 335
81.30305.9062	3482 006 036
81.30305.9062	3482 124 550
81.30305.9064	1880 092 415
81.30305.9068	3482 006 036
81.30305.9068	3482 124 550
81.30305.9075	1888 015 523
81.30305.9078	3482 124 534
81.30305.9079	1882 302 131
81.30305.9084	1882 301 239
81.30305.9084	3482 124 534
81.30305.9084	3482 124 534
81.30305.9090	3482 060 233
81.30305.9098	3482 032 331
81.30305.9099	3482 032 331
81.30305.9104	3482 102 031
81.30305.9109	3482 006 036
81.30305.9109	3482 006 036
81.30305.9109	3482 124 550
81.30305.9111	1882 301 239
81.30305.9112	3482 008 110
81.30305.9113	1882 342 134
81.30305.9114	1882 304 237
81.30305.9115	1888 015 346
81.30305.9123	1882 346 131
81.30305.9124	1882 342 134
81.30305.9137	1882 342 135
81.30305.9146	1859 212 001
81.30305.9155	3482 078 133
81.30305.9161	3482 008 141
81.30305.9164	1888 015 346
81.30305.9178	3482 078 133
81.30305.9180	3482 017 034
81.30305.9187	3482 102 031
81.30305.9191	3482 083 032
81.30305.9193	3482 083 032
81.30305.9194	3482 083 032
81.30305.9198	3482 000 467
81.30305.9200	3488 017 447
81.30305.9201	3482 120 031
81.30305.9206	3482 000 461
81.30305.9218	3482 000 361
81.30305.9219	3482 000 246
81.30305.9220	3482 000 361
81.30305.9221	3482 000 246
81.30305.9223	3482 000 464
81.30305.9226	3482 114 031
81.30305.9229	3482 000 246
81.30305.9232	3482 000 461
81.30305.9233	3482 000 467
81.30305.9235	3482 000 664
81.30305.9236	3482 000 679
81.30305.9243	3482 001 180
81.30305.9246	3482 001 145

Vergleichs-Nr. Compare No.	Artikelnummer Article No.
-------------------------------	------------------------------

MAN

81.30401.7009	1882 110 532
81.30401.7013	1881 039 532
81.30550.0015	3151 262 031
81.30550.0035	3151 000 515
81.30550.0036	3151 111 032
81.30550.0040	1863 009 100
81.30550.0043	3151 000 958
81.30550.0044	3151 199 001
81.30550.0049	3151 000 515
81.30550.0050	3151 000 395
81.30550.0052	3151 000 512
81.30550.0054	3151 000 958
81.30550.0056	3151 067 032
81.30550.0060	3151 199 001
81.30550.0063	3151 000 034
81.30550.0067	3151 000 034
81.30550.0069	3151 000 395
81.30550.0070	3151 204 001
81.30550.0071	3151 000 034
81.30550.0073	3151 000 034
81.30550.0074	3182 005 231
81.30550.0074	3182 005 231
81.30550.0077	3151 000 034
81.30550.0078	3151 000 395
81.30550.0079	3182 005 231
81.30550.0080	3151 263 031
81.30550.0082	3151 253 031
81.30550.0085	3151 262 031
81.30550.0087	3151 000 034
81.30550.0088	3151 000 034
81.30550.0089	3151 263 031
81.30550.0090	3151 000 615
81.30550.0091	3182 998 501
81.30550.0094	3151 000 034
81.30550.0096	3151 000 144
81.30550.0101	3151 000 144
81.30550.0102	3151 000 144
81.30550.0103	3151 000 034
81.30550.0104	3151 000 144
81.30550.0105	3182 998 501
81.30550.0106	3151 000 034
81.30550.0107	3151 000 034
81.30550.0109	3151 000 034
81.30550.0110	3151 000 034
81.30550.0112	3151 000 512
81.30550.0113	3151 000 335
81.30550.0114	3151 000 144
81.30550.0115	3182 600 142
81.30550.0116	3151 000 034
81.30550.0117	3151 000 335
81.30550.0249	3151 000 493
81.30550.0250	3182 600 142
81.30550.0251	3151 000 493
81.30550.0255	3151 000 493
81.30550.0261	3151 000 512
81.30550.0262	3151 000 395
81.30550.0264	3151 000 493
81.30550.6013	1863 009 100
81.30550.6021	3151 600 541
81.30550.6022	3151 600 541
81.30550.7000	1863 100 030

Vergleichsliste / Cross reference list

Vergleichs-Nr. Compare No.	Artikelnummer Article No.
-------------------------------	------------------------------

MAN

81.30550.7004	1863 101 100
81.30716.6101	3182 998 501
81.30716.6105	3182 600 142
81.32412.0002	3151 032 341
81.32412.0003	3151 032 341
81.33210.0017	1878 051 801
81.97640.0015	1805 042 000
81.99164.1328	1861 749 132
81.99164.1329	1861 748 132
81.99164.9328	1861 749 132
81.99164.9329	1861 748 132
82.30005.9001	1800 125 501
82.30005.9003	3400 700 310
82.30005.9004	3400 700 402
82.30005.9005	3400 700 403
82.30005.9006	3400 700 404
82.30301.0045	1878 005 411
82.30305.0027	3482 000 819
85.30001.7388	1878 003 662
85.30001.7390	1878 003 662
85.30001.7391	1878 003 661
85.30001.7392	1878 003 662
85.30001.9049	3482 118 031
88.30301.0009	1878 001 079
88.30301.9009	1878 001 079
88.30302.0002	1859 170 204
88.30302.0005	1859 212 000
88.30304.0003	1882 325 134
88.30305.0001	1881 039 531
88.30305.0002	1881 041 656
88.30305.0003	1882 325 134
88.30305.0012	1882 110 542
88.30305.0012	1882 110 542
88.30305.6006	1882 110 542
88.30305.6006	1882 110 542
88.30305.9002	1881 041 656
88.30305.9003	1882 325 134
88.30305.9018	1880 092 415
88.30305.9064	1880 092 415
88.30305.9203	1882 110 542
88.30305.9203	1882 110 542
88.30305.9204	1882 110 542
88.30305.9204	1882 110 542
90.39260.01	1861 600 033
90.39260.9.01	1861 600 033
90.39370.01	1861 600 033
90.39370.9.01	1861 600 033
90.43802.10	1880 092 415
90.44562.01	1882 325 134
90.90392.6001	1861 600 033
90.90392.9001	1861 600 033
90.90393.7001	1861 600 033
90.90393.9001	1861 600 033
90.90438.0210	1880 092 415
90.90440.2201	1881 039 531
90.90440.4213	1881 041 656
90.90445.6201	1882 325 134
90.90448.2307	1882 110 542
90.90448.2307	1882 110 542

Vergleichs-Nr. Compare No.	Artikelnummer Article No.
-------------------------------	------------------------------

MERCEDES-BENZ

000 250 00 04	1882 302 131
000 250 01 15	3151 021 001
000 250 03 15	3151 000 206
000 250 04 03	1861 123 236
000 250 05 03	1861 919 134
000 250 05 04	1881 089 009
000 250 06 15	3151 000 206
000 250 07 15	3151 000 206
000 250 09 03	1862 088 131
000 250 09 15	3151 000 206
000 250 11 03	1862 088 131
000 250 12 03	1862 088 131
000 250 14 03	1860 062 037
000 250 14 08	1859 250 100
000 250 15 03	1862 088 131
000 250 16 08	1859 250 102
000 250 17 04	1882 110 542
000 250 17 08	1859 250 101
000 250 17 15	3151 033 031
000 250 19 04	1882 166 737
000 250 19 04	1882 166 737
000 250 19 15	3151 000 375
000 250 21 03	1861 123 236
000 250 21 15	3151 000 206
000 250 22 03	1861 123 236
000 250 25 15	3151 000 375
000 250 31 04	1882 110 532
000 250 31 15	3151 033 031
000 250 32 03	1878 001 074
000 250 32 15	3151 021 001
000 250 33 03	1861 919 134
000 250 34 15	3151 034 031
000 250 35 03	1861 919 134
000 250 35 04	1882 230 238
000 250 36 15	3151 043 031
000 250 37 15	3151 033 031
000 250 38 04	1882 229 131
000 250 38 15	3151 043 031
000 250 39 03	1861 123 236
000 250 40 03	1861 123 236
000 250 40 04	1882 166 737
000 250 40 04	1882 166 737
000 250 40 15	3151 033 031
000 250 41 03	1861 123 236
000 250 41 04	1881 041 656
000 250 42 15	3151 044 031
000 250 43 04	1882 166 737
000 250 43 04	1882 166 737
000 250 44 15	3151 051 031
000 250 45 03	1861 123 236
000 250 45 04	1882 304 237
000 250 46 15	3151 044 031
000 250 50 04	1882 230 238
000 250 51 15	3151 000 206
000 250 52 04	1882 205 234
000 250 52 15	3151 000 206
000 250 54 15	3151 079 031
000 250 55 15	3151 069 131
000 250 55 15	3151 069 131
000 250 59 15	3151 090 131
000 250 61 03	1861 611 131

Vergleichs-Nr. Compare No.	Artikelnummer Article No.
-------------------------------	------------------------------

MERCEDES-BENZ

000 250 63 03	1861 291 136
000 250 63 04	1882 201 132
000 250 64 04	1882 229 131
000 250 64 15	3151 000 392
000 250 65 04	1881 039 532
000 250 67 04	1882 110 542
000 250 67 15	3151 090 131
000 250 68 15	3151 069 131
000 250 69 15	3151 069 032
000 250 71 04	1882 166 737
000 250 71 04	1882 166 737
000 250 73 15	3151 110 031
000 250 74 04	1882 166 737
000 250 74 04	1882 166 737
000 250 74 15	3151 000 375
000 250 75 15	3151 108 031
000 250 76 15	3151 126 031
000 250 77 15	3151 000 375
000 250 78 04	1882 229 131
000 250 78 15	3151 116 031
000 250 79 04	1882 229 131
000 250 80 15	3151 027 133
000 250 81 04	1882 231 131
000 250 82 03	1861 279 133
000 250 84 03	1861 518 031
000 250 86 01	1880 071 008
000 250 89 03	1861 279 133
000 250 91 03	1878 001 074
000 250 92 03	1878 000 104
000 250 92 15	3151 166 031
000 250 93 03	1861 470 234
000 250 93 04	1882 234 433
000 250 95 15	3151 170 131
000 250 99 03	1861 279 133
000 250 99 04	1882 205 234
000 252 00 05	1864 464 031
000 252 05 22	1866 030 102
000 252 06 46	3496 006 000
000 252 07 05	3000 951 784
000 252 15 11	3000 951 784
000 252 30 05	3000 951 784
000 252 61 05	3000 951 111
000 252 80 05	3000 951 824
000 254 01 94	1805 042 000
000 254 02 20	3151 000 958
000 254 03 20	3182 998 501
000 254 03 94	3130 010 100
000 254 04 20	3182 998 501
000 254 13 08	3182 997 801
000 254 14 08	3182 997 801
000 254 15 08	3182 997 803
000 254 16 08	3182 997 804
000 254 17 08	3182 997 802
000 254 18 08	3182 997 801
000 254 25 08	3182 997 804
000 254 28 08	3182 997 802
000 254 30 08	3151 000 144
000 254 30 20	3182 998 501
000 254 32 08	3151 000 493
000 290 32 12	6284 600 573
000 295 80 07	6283 600 113

Vergleichsliste / Cross reference list

Vergleichs-Nr. Compare No.	Artikelnummer Article No.
-------------------------------	------------------------------

MERCEDES-BENZ

000 295 88 07	6283 600 113
000 295 89 07	6283 600 113
000 981 66 27	1863 837 002
000 981 67 25	1863 840 001
000 981 67 27	1863 837 002
000 981 70 25	1863 837 003
000 981 75 25	1863 840 001
000 981 96 27	1863 837 002
000 981 97 27	1863 855 000
001 250 00 03	1861 279 133
001 250 00 04	1882 234 433
001 250 01 04	1882 110 542
001 250 01 15	3151 248 031
001 250 02 03	1878 001 074
001 250 02 15	3151 248 031
001 250 03 04	1882 252 331
001 250 04 04	1882 252 333
001 250 04 15	3151 182 031
001 250 05 03	1861 919 134
001 250 05 15	3151 000 278
001 250 06 03	1861 291 136
001 250 06 15	3151 000 547
001 250 07 04	1882 166 737
001 250 07 04	1882 166 737
001 250 08 04	1882 166 737
001 250 08 04	1882 166 737
001 250 08 15	3151 170 131
001 250 09 15	3151 000 549
001 250 13 01	1862 718 002
001 250 14 15	3151 204 001
001 250 20 03	1861 557 236
001 250 22 15	3151 000 374
001 250 25 15	3151 248 031
001 250 26 03	1861 279 133
001 250 27 03	1878 001 074
001 250 36 03	1861 919 134
001 250 38 03	1861 279 133
001 250 39 03	1861 279 133
001 250 40 03	1861 919 134
001 250 41 04	3082 121 031
001 250 42 04	3082 121 031
001 250 42 04	3082 121 031
001 250 43 04	3082 078 032
001 250 43 15	3182 003 131
001 250 44 15	3182 002 131
001 250 45 15	3151 182 031
001 250 47 15	3151 000 549
001 250 48 03	1861 518 031
001 250 48 15	3151 000 278
001 250 49 03	1861 518 031
001 250 49 15	3151 000 547
001 250 52 04	1882 205 234
001 250 53 04	1882 166 737
001 250 55 03	1878 000 104
001 250 57 03	1878 001 074
001 250 58 03	1878 000 104
001 250 59 03	1861 303 248
001 250 60 03	1861 303 248
001 250 62 15	3151 000 549
001 250 63 15	3151 000 549
001 250 64 15	3151 000 278

Vergleichs-Nr. Compare No.	Artikelnummer Article No.
-------------------------------	------------------------------

MERCEDES-BENZ

001 250 65 15	3151 000 278
001 250 66 15	3151 000 547
001 250 67 03	1878 000 104
001 250 67 15	3151 000 547
001 250 68 04	1882 166 737
001 250 69 03	1861 840 133
001 250 72 15	3151 248 031
001 250 74 04	1882 234 433
001 250 75 04	1882 205 234
001 250 76 03	1861 518 031
001 250 78 04	1882 282 331
001 250 79 15	3151 000 278
001 250 80 15	3151 000 547
001 250 81 15	3151 000 549
001 250 83 03	1878 000 104
001 250 84 04	1882 288 131
001 250 84 15	3151 000 549
001 250 86 03	1861 611 131
001 250 86 15	3151 000 278
001 250 87 04	1882 231 131
001 250 88 15	3151 000 547
001 250 90 04	1882 252 333
001 250 91 15	3151 044 031
001 250 92 15	3151 000 497
001 250 93 15	3151 044 031
001 250 97 01	3400 122 801
001 250 97 03	1878 001 074
001 250 97 15	3151 000 549
001 250 98 15	3151 000 278
001 250 99 15	3151 000 396
001 252 19 05	3000 951 188
001 252 32 05	3000 951 111
001 252 33 05	3000 951 112
001 252 61 05	3000 951 824
001 252 62 05	3000 951 188
001 981 32 27	1863 855 000
001 981 33 27	1863 837 002
002 250 00 15	3151 000 396
002 250 02 04	3488 000 158
002 250 03 04	3482 124 522
002 250 04 03	1861 303 248
002 250 04 04	3482 124 522
002 250 05 03	1878 000 104
002 250 05 15	3151 248 031
002 250 08 15	3151 000 547
002 250 11 15	3182 002 132
002 250 13 03	1878 001 074
002 250 14 03	1878 001 074
002 250 16 04	1882 282 331
002 250 19 15	3182 998 501
002 250 21 15	3182 998 501
002 250 22 15	3182 998 501
002 250 24 15	3182 600 101
002 250 25 03	1861 384 334
002 250 25 15	3182 600 101
002 250 27 15	3182 998 501
002 250 28 15	3182 600 101
002 250 29 15	3182 998 501
002 250 30 15	3182 600 101
002 250 30 15	3182 600 101
002 250 30 15	3182 998 501

Vergleichs-Nr. Compare No.	Artikelnummer Article No.
-------------------------------	------------------------------

MERCEDES-BENZ

002 250 31 04	1882 302 131
002 250 31 15	3182 998 501
002 250 32 04	1882 301 239
002 250 32 15	3151 000 497
002 250 33 03	1861 410 047
002 250 34 03	1861 303 248
002 250 35 03	1861 291 136
002 250 36 04	1882 302 132
002 250 37 15	3100 000 003
002 250 39 03	1861 303 248
002 250 39 04	1882 302 131
002 250 40 04	1882 302 131
002 250 40 15	3100 000 003
002 250 41 04	1882 301 239
002 250 43 03	1861 840 133
002 250 44 15	3151 000 335
002 250 45 04	1882 304 237
002 250 45 15	3151 000 157
002 250 46 04	3082 121 031
002 250 47 04	3082 121 031
002 250 48 15	3182 003 131
002 250 49 15	3151 000 335
002 250 51 15	3182 998 501
002 250 52 15	3182 600 101
002 250 55 15	3182 600 141
002 250 58 15	3182 600 166
002 250 60 15	3182 600 172
002 250 61 04	1882 305 131
002 250 61 15	3151 000 374
002 250 62 15	3182 600 101
002 250 63 03	1861 470 234
002 250 63 15	3151 000 335
002 250 64 03	1861 470 234
002 250 64 04	1882 305 132
002 250 65 03	1861 470 234
002 250 65 15	3151 000 396
002 250 66 15	3182 998 501
002 250 68 04	1882 311 131
002 250 68 15	3100 000 003
002 250 70 04	3482 008 038
002 250 71 04	3482 008 038
002 250 72 04	3082 121 031
002 250 72 15	3182 600 101
002 250 73 04	3082 121 031
002 250 73 15	3182 600 141
002 250 74 03	1861 291 136
002 250 74 15	3182 600 166
002 250 75 04	3482 000 953
002 250 75 04	3482 011 331
002 250 75 15	3182 600 172
002 250 76 15	3182 600 101
002 250 77 04	1882 304 237
002 250 77 15	3100 000 003
002 250 81 01	1888 893 001
002 250 81 04	3482 124 522
002 250 82 15	3100 000 003
002 250 83 01	1888 877 101
002 250 83 15	3151 000 335
002 250 84 04	1882 317 131
002 250 87 04	3482 012 211
002 250 88 03	1861 303 248

Vergleichsliste / Cross reference list

Vergleichs-Nr. Compare No.	Artikelnummer Article No.
-------------------------------	------------------------------

MERCEDES-BENZ

002 250 88 15	3151 000 157
002 250 89 01	1888 893 001
002 250 94 04	1882 252 331
002 250 95 04	1882 252 333
002 250 96 04	1882 305 131
002 250 97 03	1878 000 105
002 250 97 04	1882 305 132
002 250 97 15	3151 000 615
002 250 98 03	1878 000 105
002 250 99 03	1878 002 706
002 250 99 04	1882 301 239
002 250 99 15	3100 000 003
002 295 06 07	6283 600 115
002 295 08 07	6283 600 539
002 295 21 07	6283 600 115
002 295 22 07	6283 600 539
003 250 00 03	1878 002 706
003 250 00 04	1882 301 239
003 250 02 04	3082 078 032
003 250 04 04	1882 288 131
003 250 06 03	1878 000 105
003 250 06 04	3482 008 032
003 250 07 03	1878 001 136
003 250 08 04	3082 078 032
003 250 09 03	1878 000 105
003 250 09 04	1882 301 238
003 250 09 04	3482 124 541
003 250 09 04	3482 124 541
003 250 10 04	1882 205 234
003 250 11 03	1862 718 002
003 250 12 04	1882 317 131
003 250 13 03	1862 718 002
003 250 13 04	1882 230 238
003 250 14 04	1881 041 656
003 250 14 15	3151 000 335
003 250 15 15	3151 000 157
003 250 16 04	1882 234 433
003 250 20 04	1882 166 737
003 250 20 04	1882 166 737
003 250 21 04	1882 166 737
003 250 21 04	1882 166 737
003 250 22 03	1861 611 131
003 250 22 04	1882 166 737
003 250 22 15	3151 000 493
003 250 23 04	1882 311 131
003 250 24 01	1888 877 101
003 250 24 04	1882 302 132
003 250 25 04	1882 302 131
003 250 26 03	1861 966 141
003 250 26 04	1882 301 239
003 250 27 04	1882 302 131
003 250 28 04	1882 302 131
003 250 32 04	1882 330 032
003 250 33 03	1861 279 133
003 250 33 04	1882 301 238
003 250 33 04	3482 124 541
003 250 33 04	3482 124 541
003 250 34 04	1882 110 542
003 250 35 15	6482 000 219
003 250 37 04	3082 121 031
003 250 38 03	1862 088 131

Vergleichs-Nr. Compare No.	Artikelnummer Article No.
-------------------------------	------------------------------

MERCEDES-BENZ

003 250 39 03	1861 840 133
003 250 40 04	3482 012 240
003 250 41 03	1861 518 031
003 250 41 04	1882 301 239
003 250 42 03	1861 384 334
003 250 45 04	3082 156 031
003 250 46 04	3082 156 031
003 250 48 04	3482 002 234
003 250 50 03	1862 718 002
003 250 51 03	1878 000 104
003 250 53 03	1861 966 141
003 250 53 04	1888 042 009
003 250 54 04	3482 012 211
003 250 56 03	1878 001 070
003 250 57 03	1861 557 236
003 250 59 04	3482 012 237
003 250 61 03	1861 421 032
003 250 61 04	1882 342 134
003 250 62 03	1878 001 070
003 250 65 03	1861 557 236
003 250 65 04	3482 008 038
003 250 66 04	3082 121 031
003 250 68 15	3151 000 157
003 250 69 03	1861 557 236
003 250 69 15	3151 000 335
003 250 70 04	1882 301 239
003 250 70 15	6482 000 218
003 250 71 03	1878 634 014
003 250 71 04	1882 302 135
003 250 73 03	1878 001 136
003 250 73 15	3151 001 082
003 250 74 03	1878 000 105
003 250 74 04	1888 042 009
003 250 75 15	3151 001 083
003 250 77 04	3082 156 031
003 250 78 04	3082 156 031
003 250 79 03	1878 002 706
003 250 79 04	3082 121 031
003 250 80 04	3082 121 031
003 250 82 03	1861 303 248
003 250 83 03	1861 303 248
003 250 83 04	1882 341 001
003 250 84 03	1861 571 236
003 250 84 04	3482 002 234
003 250 86 03	1861 303 248
003 250 86 04	1882 342 134
003 250 88 03	1861 643 134
003 250 88 04	3482 124 522
003 250 88 04	3482 124 522
003 250 89 03	1878 001 136
003 250 90 04	1882 342 134
003 250 91 04	3082 121 031
003 250 92 04	1888 042 009
003 250 93 04	3482 054 131
003 250 94 04	3482 055 132
003 250 95 03	1878 000 964
003 250 96 04	3482 046 031
003 250 98 01	1888 067 042
003 250 98 04	3482 008 038
003 250 99 04	3482 012 240
004 250 00 04	3482 124 522

Vergleichs-Nr. Compare No.	Artikelnummer Article No.
-------------------------------	------------------------------

MERCEDES-BENZ

004 250 05 04	1882 346 131
004 250 05 04	1882 346 131
004 250 07 04	3482 012 237
004 250 11 04	3482 008 038
004 250 14 03	1878 001 136
004 250 19 04	3082 156 031
004 250 20 04	3082 157 031
004 250 23 03	1861 611 131
004 250 23 04	3082 156 031
004 250 23 04	3082 156 031
004 250 24 04	3482 000 953
004 250 24 04	3482 051 131
004 250 26 03	1861 594 034
004 250 27 03	1861 594 034
004 250 28 03	1861 603 034
004 250 29 03	1861 603 034
004 250 30 03	1861 594 034
004 250 31 04	3082 156 031
004 250 34 04	1888 055 247
004 250 35 04	1888 055 247
004 250 36 04	1888 055 247
004 250 40 04	1888 055 041
004 250 41 04	1888 055 041
004 250 42 03	1861 384 334
004 250 44 04	3488 017 432
004 250 45 04	3488 017 432
004 250 45 04	3488 017 432
004 250 46 04	3482 081 231
004 250 47 03	1861 611 131
004 250 47 04	1888 055 041
004 250 49 03	1861 303 248
004 250 51 04	3482 055 132
004 250 52 03	1878 000 964
004 250 54 04	1882 349 003
004 250 55 04	1888 055 041
004 250 56 04	3482 081 232
004 250 58 04	3482 081 232
004 250 60 04	3482 081 232
004 250 61 04	3482 081 231
004 250 63 05	1863 600 123
004 250 66 03	1861 919 134
004 250 69 03	1861 966 141
004 250 70 04	1888 042 009
004 250 71 03	1861 594 034
004 250 71 04	1888 042 009
004 250 72 03	1861 632 032
004 250 72 04	1888 042 009
004 250 73 03	1878 001 070
004 250 73 04	1888 055 041
004 250 79 04	1888 063 137
004 250 80 01	1888 067 042
004 250 80 04	1888 063 137
004 250 81 01	1888 067 042
004 250 83 04	3082 078 032
004 250 86 03	1861 384 334
004 250 87 04	3482 081 231
004 250 88 04	3482 081 232
004 250 88 04	3482 081 232
004 250 89 03	1861 470 234
004 250 89 04	3482 081 233
004 250 90 03	1878 001 074

Vergleichsliste / Cross reference list

Vergleichs-Nr. Compare No.	Artikelnummer Article No.
-------------------------------	------------------------------

MERCEDES-BENZ

004 250 91 03	1861 470 234
004 250 91 04	1888 063 137
004 250 92 04	1888 063 137
004 250 93 04	1888 063 137
004 250 96 04	1888 042 009
004 250 97 01	1888 893 001
004 250 97 04	1888 055 247
004 250 98 03	1861 667 034
004 250 98 04	1888 055 041
004 250 99 04	1888 063 137
004 981 21 25	1863 869 028
005 250 01 03	1878 002 706
005 250 02 03	1878 002 706
005 250 02 04	1888 055 247
005 250 03 01	1888 067 031
005 250 03 04	1888 055 247
005 250 04 04	1888 055 247
005 250 04 04	1888 055 247
005 250 06 03	1861 303 248
005 250 06 04	3482 002 239
005 250 07 03	1861 303 248
005 250 08 04	3482 012 237
005 250 09 04	1882 019 133
005 250 09 04	1882 019 133
005 250 11 04	1882 349 003
005 250 14 04	1888 063 137
005 250 15 04	1888 063 137
005 250 16 04	1888 063 137
005 250 19 03	1878 001 144
005 250 19 03	1878 001 147
005 250 19 04	3482 124 522
005 250 20 03	1861 923 032
005 250 20 03	1878 001 152
005 250 21 03	1878 003 657
005 250 22 03	1878 003 657
005 250 23 03	1878 003 657
005 250 24 03	1878 001 144
005 250 24 03	1878 001 147
005 250 28 04	3483 023 032
005 250 33 01	1888 877 102
005 250 39 03	1878 001 070
005 250 39 04	3482 055 132
005 250 40 03	1878 001 070
005 250 43 03	1878 000 105
005 250 46 04	3482 106 031
005 250 47 04	3482 106 133
005 250 49 01	1888 877 102
005 250 49 03	1861 470 234
005 250 50 03	1878 001 136
005 250 50 04	3483 023 001
005 250 51 04	3483 023 001
005 250 52 04	3482 051 132
005 250 53 03	1861 571 236
005 250 54 03	1861 741 042
005 250 55 03	1861 571 236
005 250 57 03	1878 000 105
005 250 60 03	1878 002 878
005 250 61 03	1878 002 878
005 250 62 04	3482 081 233
005 250 64 03	1878 000 105
005 250 64 04	3483 030 032

Vergleichs-Nr. Compare No.	Artikelnummer Article No.
-------------------------------	------------------------------

MERCEDES-BENZ

005 250 66 04	3483 030 032
005 250 70 03	1861 840 133
005 250 76 04	3488 017 432
005 250 77 03	1878 001 077
005 250 77 04	3488 017 432
005 250 77 04	3488 017 432
005 250 83 04	3482 081 232
005 250 84 04	3482 081 231
005 250 86 01	1888 067 031
005 250 87 04	3488 017 432
005 250 88 04	3488 017 432
005 250 89 03	1861 840 133
005 250 93 04	3483 030 031
005 250 94 03	1861 919 134
005 250 94 04	3483 030 031
005 250 95 03	1861 919 134
006 250 01 04	3082 267 233
006 250 04 04	3082 268 031
006 250 05 03	1861 936 142
006 250 07 04	3082 269 031
006 250 10 04	3482 008 038
006 250 12 03	1878 001 136
006 250 13 04	3482 054 131
006 250 14 03	1861 667 034
006 250 14 04	3483 000 139
006 250 17 03	1878 002 706
006 250 19 03	1862 962 002
006 250 19 04	3082 267 233
006 250 20 04	3082 267 233
006 250 21 04	3082 267 233
006 250 22 04	3082 268 031
006 250 23 04	3082 268 031
006 250 24 04	3082 268 031
006 250 25 04	3082 269 031
006 250 26 04	3082 269 031
006 250 27 04	3082 269 031
006 250 28 04	3482 106 133
006 250 30 04	3482 000 462
006 250 34 04	3482 000 463
006 250 35 03	1861 936 142
006 250 44 04	1888 063 137
006 250 45 03	1878 000 105
006 250 45 04	1888 063 137
006 250 46 03	1878 000 105
006 250 47 03	1861 923 032
006 250 47 03	1878 001 152
006 250 47 04	3488 023 031
006 250 48 04	3488 023 031
006 250 49 04	3488 023 031
006 250 50 04	3082 267 233
006 250 51 04	3082 267 233
006 250 52 04	3082 267 233
006 250 55 03	1878 634 014
006 250 58 04	3082 267 233
006 250 59 04	3082 267 233
006 250 60 04	3082 267 233
006 250 62 03	1861 956 133
006 250 65 04	3082 268 031
006 250 67 04	3482 000 462
006 250 72 04	1888 055 247
006 250 73 04	3483 000 139

Vergleichs-Nr. Compare No.	Artikelnummer Article No.
-------------------------------	------------------------------

MERCEDES-BENZ

006 250 75 03	1861 964 034
006 250 76 03	1861 643 134
006 250 77 03	1878 001 136
006 250 78 03	1861 384 334
006 250 79 03	1861 964 034
006 250 80 03	1861 964 034
006 250 81 03	1861 963 033
006 250 82 03	1861 963 033
006 250 83 03	1878 001 144
006 250 84 03	1878 001 144
006 250 86 04	3488 023 031
006 250 87 03	1878 003 657
006 250 87 04	3488 023 031
006 250 88 04	3488 023 031
006 250 89 03	1861 470 234
006 250 90 03	1878 000 105
006 250 95 03	1862 123 131
006 250 96 03	1862 123 131
006 250 96 03	1862 123 131
007 250 02 03	1862 122 132
007 250 03 03	1862 122 132
007 250 05 03	1878 003 657
007 250 05 04	3488 023 031
007 250 06 04	3488 023 031
007 250 07 04	3488 023 031
007 250 08 03	1878 000 105
007 250 09 03	1878 000 105
007 250 10 03	1878 000 105
007 250 12 03	1878 001 136
007 250 13 03	1878 001 136
007 250 14 04	3483 000 139
007 250 15 04	3482 000 463
007 250 18 03	1861 919 134
007 250 19 03	1861 919 134
007 250 21 03	1861 291 136
007 250 23 04	3482 000 464
007 250 24 04	3482 000 464
007 250 28 03	1861 571 236
007 250 28 04	3488 023 031
007 250 29 03	1861 571 236
007 250 29 04	3488 023 031
007 250 30 03	1878 001 070
007 250 30 04	3488 023 031
007 250 32 04	3488 023 031
007 250 33 04	3488 023 031
007 250 34 04	3488 023 031
007 250 38 03	1878 000 104
007 250 42 03	1878 002 706
007 250 43 03	1878 002 706
007 250 44 04	3488 023 031
007 250 45 04	3488 000 102
007 250 46 03	1862 135 035
007 250 46 04	3488 023 031
007 250 47 03	1862 135 035
007 250 47 04	3488 023 031
007 250 49 03	1862 138 032
007 250 50 03	1862 138 032
007 250 51 04	3488 023 031
007 250 55 03	1861 923 032
007 250 55 03	1878 001 152
007 250 57 04	3483 000 258

Vergleichsliste / Cross reference list

Vergleichs-Nr. Compare No.	Artikelnummer Article No.
-------------------------------	------------------------------

MERCEDES-BENZ

007 250 58 03	1878 080 037
007 250 60 03	1878 005 805
007 250 60 03	1878 634 022
007 250 61 03	1878 005 805
007 250 61 03	1878 634 022
007 250 61 04	3483 030 032
007 250 67 03	1878 002 706
007 250 68 03	1878 002 706
007 250 69 03	1878 002 706
007 250 72 03	1861 571 236
007 250 72 04	3488 000 158
007 250 74 03	1878 001 070
007 250 74 04	3483 000 139
007 250 77 04	3488 000 158
007 250 79 04	3483 030 031
007 250 80 04	3483 000 258
007 250 81 04	3483 030 032
007 250 82 03	1861 557 236
007 250 82 04	3488 023 031
007 250 83 03	1861 557 236
007 250 83 04	3483 000 139
007 250 84 04	3488 000 102
007 250 86 03	1861 557 236
007 250 86 03	1878 634 052
007 250 88 01	1888 877 102
007 250 89 04	3488 017 410
007 250 90 01	1888 067 031
007 250 92 01	1888 893 001
007 250 95 03	1861 936 142
007 250 96 03	1861 936 142
007 250 96 04	3488 000 102
007 250 97 03	1861 936 142
007 250 97 04	3483 030 032
007 250 98 03	1861 964 034
007 250 99 03	1861 964 034
008 250 00 04	3488 000 158
008 250 06 03	1861 963 033
008 250 08 03	1878 001 144
008 250 10 04	3488 023 031
008 250 13 03	1878 005 805
008 250 13 03	1878 634 023
008 250 13 04	3488 000 158
008 250 14 03	1878 005 805
008 250 14 03	1878 634 023
008 250 16 03	1862 135 035
008 250 17 03	1862 138 032
008 250 19 03	1878 005 668
008 250 19 04	3488 023 031
008 250 20 03	1878 005 668
008 250 22 03	1861 919 134
008 250 23 03	1861 919 134
008 250 24 04	3483 030 032
008 250 25 04	3483 000 258
008 250 27 03	1878 634 016
008 250 28 03	1878 634 016
008 250 30 04	3483 030 032
008 250 31 04	3483 030 031
008 250 32 04	3483 000 258
008 250 35 04	3488 023 031
008 250 36 03	1878 005 668
008 250 36 04	3488 023 031

Vergleichs-Nr. Compare No.	Artikelnummer Article No.
-------------------------------	------------------------------

MERCEDES-BENZ

008 250 37 03	1878 005 668
008 250 38 04	3488 000 158
008 250 39 04	3488 000 158
008 250 42 03	1861 713 133
008 250 42 04	3488 023 031
008 250 43 03	1861 384 334
008 250 43 04	3483 000 139
008 250 44 04	3483 030 032
008 250 45 04	3488 000 102
008 250 46 03	1878 001 144
008 250 46 03	1878 001 147
008 250 47 03	1888 055 041
008 250 51 03	1878 005 668
008 250 57 04	3482 000 679
008 250 59 04	3488 000 158
008 250 60 03	1878 065 131
008 250 68 03	1864 464 031
008 250 72 03	1861 303 248
008 250 74 03	1878 002 878
008 250 76 03	1878 634 014
008 250 80 03	1878 000 968
008 250 82 03	1862 135 035
008 250 83 03	1862 138 032
008 250 84 01	1888 877 102
008 250 90 03	1878 087 141
008 250 90 03	1878 087 141
008 250 92 04	3488 000 366
008 250 95 03	1862 211 031
008 250 97 03	1862 304 033
008 250 98 03	1862 304 033
008 250 99 04	3482 000 851
009 250 01 03	1862 305 033
009 250 02 03	1862 305 033
009 250 05 04	3488 000 158
009 250 07 04	3483 030 031
009 250 08 04	3483 030 032
009 250 09 04	3483 000 258
009 250 10 04	3483 000 422
009 250 12 03	1861 303 248
009 250 13 03	1861 303 248
009 250 14 03	1861 741 042
009 250 14 04	3488 023 031
009 250 15 04	3488 023 031
009 250 17 03	1862 225 132
009 250 18 03	1862 225 132
009 250 18 04	3488 000 102
009 250 19 03	1878 080 031
009 250 20 03	1878 080 033
009 250 21 03	1878 080 037
009 250 21 04	3483 000 139
009 250 22 04	3483 030 032
009 250 23 04	3488 023 031
009 250 24 04	3488 000 158
009 250 25 04	3488 023 031
009 250 31 03	1878 080 037
009 250 32 03	1861 279 133
009 250 32 03	1861 279 133
009 250 33 03	1861 279 133
009 250 33 04	3483 000 461
009 250 40 03	1878 001 074
009 250 40 04	3482 000 852

Vergleichs-Nr. Compare No.	Artikelnummer Article No.
-------------------------------	------------------------------

MERCEDES-BENZ

009 250 41 03	1861 470 234
009 250 45 03	1878 003 657
009 250 52 03	1861 956 133
009 250 53 03	1861 956 133
009 250 55 03	1861 384 334
009 250 56 03	1861 384 334
009 250 57 03	1861 667 034
009 250 58 03	1861 840 133
009 250 59 03	1861 840 133
009 250 60 03	1861 603 034
009 250 61 03	1861 603 034
009 250 62 03	1861 713 133
009 250 63 03	1861 713 133
009 250 64 03	1861 713 133
009 250 65 03	1861 713 133
009 250 67 03	1861 594 034
009 250 73 01	1888 998 902
009 250 80 03	1861 713 133
009 250 81 03	1862 718 002
009 250 82 03	1861 966 141
009 250 83 04	3483 030 032
009 250 85 03	1862 962 002
009 250 85 04	3488 000 158
009 250 93 03	1860 062 037
009 250 95 01	1888 877 101
009 250 96 01	1888 067 042
009 250 96 03	1861 279 133
009 250 96 03	1861 279 133
009 250 97 01	1888 067 031
010 250 00 03	1878 000 105
010 250 02 03	1861 410 047
010 250 05 03	1861 421 032
010 250 07 04	3483 030 032
010 250 09 03	1861 574 132
010 250 09 04	3483 000 422
010 250 10 04	3483 000 422
010 250 11 04	3483 000 258
010 250 12 03	1861 123 236
010 250 13 03	1861 632 032
010 250 14 03	1878 000 964
010 250 15 04	3488 000 158
010 250 17 03	1861 643 134
010 250 17 04	3488 000 158
010 250 18 03	1878 002 706
010 250 18 04	3488 000 102
010 250 21 04	3483 030 032
010 250 22 03	1878 000 964
010 250 22 04	3483 000 461
010 250 36 03	1861 470 234
010 250 47 03	1862 268 031
010 250 47 03	1878 003 269
010 250 48 03	1862 268 031
010 250 48 03	1878 003 269
010 250 57 03	1878 002 735
010 250 58 03	1878 002 735
010 250 61 03	1862 304 033
010 250 62 03	1862 304 033
010 250 63 03	1862 304 033
010 250 65 03	1862 305 033
010 250 66 03	1862 305 033
010 250 67 03	1862 305 033

Vergleichs-Nr. Compare No.	Artikelnummer Article No.
-------------------------------	------------------------------

MERCEDES-BENZ

010 250 69 03	1861 936 142
010 250 70 03	1861 936 142
010 250 72 03	1861 936 142
010 250 73 03	1861 936 142
010 250 75 03	1862 123 131
010 250 76 03	1862 122 132
010 250 77 03	1862 135 035
010 250 78 03	1862 138 032
010 250 79 03	1862 304 033
010 250 80 03	1862 305 033
010 250 83 03	1861 741 042
010 250 84 03	1862 962 002
010 250 85 03	1861 919 134
010 250 86 03	1861 303 248
010 250 88 03	1878 005 805
010 250 88 03	1878 634 022
010 250 89 03	1878 005 805
010 250 89 03	1878 634 022
010 250 91 03	1878 005 805
010 250 91 03	1878 634 023
010 250 92 03	1878 005 805
010 250 92 03	1878 634 023
010 250 95 03	1864 464 031
010 250 97 03	1864 464 031
010 981 31 25	1863 869 028
010 981 56 25	1863 869 028
011 250 00 03	1878 000 105
011 250 01 03	1878 000 105
011 250 02 03	1878 000 105
011 250 04 03	1878 005 668
011 250 06 03	1878 080 037
011 250 13 03	1862 123 131
011 250 14 03	1862 123 131
011 250 15 03	1862 123 131
011 250 15 03	1862 123 131
011 250 17 03	1862 122 132
011 250 18 03	1862 122 132
011 250 19 03	1862 122 132
011 250 22 03	1864 464 031
011 250 25 03	1862 299 032
011 250 25 03	1862 299 032
011 250 27 03	1862 286 031
011 250 30 03	1878 080 031
011 250 61 03	1862 304 033
011 250 62 03	1862 304 033
011 250 62 03	1862 304 033
011 250 63 03	1862 304 033
011 250 65 03	1862 305 033
011 250 66 03	1862 305 033
011 250 67 03	1862 305 033
011 250 70 03	1862 088 131
011 250 71 03	1861 611 131
011 250 72 03	1861 594 034
011 250 74 03	1861 571 236
011 250 81 03	1878 001 144
011 250 90 03	1878 080 033
011 250 95 03	1862 122 132
011 250 96 03	1862 122 132
011 250 98 03	1862 123 131
011 250 98 03	1862 123 131
011 250 99 03	1862 123 131

Vergleichs-Nr. Compare No.	Artikelnummer Article No.
-------------------------------	------------------------------

MERCEDES-BENZ

011 250 99 03	1862 123 131
012 250 02 03	1878 001 152
012 250 03 03	1878 001 152
012 250 04 03	1878 001 152
012 250 14 03	1878 080 037
012 250 15 01	1888 600 101
012 250 15 03	1878 080 037
012 250 16 01	1888 877 103
012 250 17 03	1878 080 033
012 250 18 03	1878 080 033
012 250 24 03	1878 003 657
012 250 25 03	1878 003 657
012 250 33 03	1862 211 031
012 250 36 03	1861 384 334
012 250 53 03	1878 080 033
012 250 58 03	1878 080 031
012 250 65 03	1861 923 032
012 250 65 03	1878 001 152
012 250 69 03	1878 000 105
012 250 84 03	1878 080 033
012 250 85 03	1878 080 033
012 250 93 03	1878 065 131
013 250 01 03	1878 065 131
013 250 08 03	1878 080 033
013 250 13 03	1878 080 031
013 250 14 03	1878 080 031
013 250 16 03	1878 080 033
013 250 17 03	1878 080 033
013 250 18 03	1878 080 031
013 250 20 03	1878 080 037
013 250 21 03	1878 080 037
013 250 25 03	1878 080 031
013 250 26 03	1878 005 668
013 250 27 03	1878 080 031
013 250 28 03	1878 080 033
013 250 30 03	1878 080 037
013 250 33 03	1878 080 033
013 250 35 03	1878 080 033
013 250 36 01	1888 998 901
013 250 39 03	1878 080 037
013 250 41 03	1878 005 668
013 250 42 03	1878 080 031
013 250 49 03	1862 408 031
013 250 54 03	1861 919 134
013 250 71 03	1878 080 033
013 250 74 03	1878 002 735
013 250 79 03	1878 002 735
013 250 80 03	1864 464 031
013 250 81 03	1864 464 031
013 250 82 03	1861 303 248
013 250 85 03	1878 074 641
013 250 87 03	1878 002 735
013 250 88 03	1878 002 735
013 250 89 03	1861 919 134
013 250 92 03	1861 303 248
013 250 94 03	1862 299 032
013 250 95 03	1861 963 033
013 250 95 03	1861 963 033
013 250 98 03	1861 964 034
013 250 98 03	1861 964 034
014 250 20 03	1862 299 032

Vergleichs-Nr. Compare No.	Artikelnummer Article No.
-------------------------------	------------------------------

MERCEDES-BENZ

014 250 21 03	1862 299 032
014 250 27 03	1862 299 032
014 250 27 03	1862 299 032
014 250 28 03	1862 299 032
014 250 35 03	1864 503 231
014 250 36 03	1864 503 231
014 250 41 03	1864 504 031
014 250 42 03	1864 504 031
014 250 43 03	1864 504 031
014 250 53 03	1878 074 641
014 250 54 03	1878 074 641
014 250 56 03	1861 963 033
014 250 57 03	1861 963 033
014 250 64 03	1861 963 033
014 250 65 03	1861 963 033
014 250 76 03	1878 002 735
014 250 77 03	1878 002 735
014 250 78 03	1878 002 735
014 250 79 01	1888 998 902
014 250 80 01	1888 916 001
014 250 82 03	1861 936 142
014 250 83 03	1861 936 142
014 250 84 03	1878 080 037
014 250 88 03	1861 279 133
014 250 89 03	1861 279 133
014 250 89 03	1861 279 133
014 250 94 03	1861 291 136
014 250 95 03	1878 003 780
014 250 99 03	1878 080 033
015 250 00 03	1878 080 033
015 250 02 03	1878 080 037
015 250 07 03	1878 994 001
015 250 08 03	1878 994 001
015 250 09 03	1878 994 001
015 250 12 03	1878 005 187
015 250 13 03	1864 464 031
015 250 14 03	1864 464 031
015 250 15 03	1864 464 031
015 250 16 03	1864 503 231
015 250 17 03	1864 503 231
015 250 18 03	1864 503 231
015 250 19 03	1878 600 501
015 250 22 03	1878 005 668
015 250 23 03	1878 080 037
015 250 24 03	1878 002 735
015 250 25 03	1862 286 031
015 250 26 03	1878 992 401
015 250 28 03	1878 080 033
015 250 30 03	1878 080 033
015 250 33 01	3000 297 002
015 250 33 01	3000 297 002
015 250 33 03	1862 211 031
015 250 34 01	3000 297 002
015 250 34 01	3000 297 002
015 250 34 03	1878 003 657
015 250 36 03	1878 003 657
015 250 37 01	3000 297 002
015 250 37 03	1878 003 662
015 250 39 03	1878 080 031
015 250 40 01	3000 297 002
015 250 40 03	1878 080 031

Vergleichsliste / Cross reference list

Vergleichs-Nr. Compare No.	Artikelnummer Article No.
-------------------------------	------------------------------

MERCEDES-BENZ

015 250 46 03	1878 023 831
015 250 57 01	1888 998 201
015 250 63 03	1878 023 831
015 250 65 03	1862 304 033
015 250 66 03	1862 304 033
015 250 68 03	1862 305 033
015 250 68 03	1862 305 033
015 250 79 03	1878 002 024
015 250 80 03	1878 002 024
015 250 81 03	1878 002 024
015 250 83 03	1878 002 023
015 250 84 03	1878 002 023
015 250 85 03	1878 002 023
015 250 93 03	1862 122 132
015 250 94 03	1862 123 131
015 250 94 03	1862 123 131
015 250 98 03	1878 002 732
015 250 99 03	1878 002 732
016 250 00 03	1878 002 732
016 250 01 03	1878 002 732
016 250 03 03	1878 002 732
016 250 04 03	1878 002 732
016 250 05 03	1878 002 732
016 250 07 03	1878 080 031
016 250 08 03	1878 080 031
016 250 09 03	1878 005 668
016 250 10 03	1878 005 668
016 250 12 03	1878 080 031
016 250 13 03	1878 080 031
016 250 14 03	1878 080 033
016 250 15 03	1878 080 033
016 250 16 03	1878 080 033
016 250 17 03	1878 080 037
016 250 18 03	1878 080 037
016 250 19 03	1878 005 805
016 250 19 03	1878 634 022
016 250 25 03	1878 080 031
016 250 26 03	1878 080 031
016 250 27 03	1878 005 668
016 250 28 01	3000 951 784
016 250 28 03	1878 005 668
016 250 29 03	1878 080 031
016 250 30 03	1878 080 033
016 250 31 03	1878 080 033
016 250 32 03	1878 080 033
016 250 33 03	1878 080 033
016 250 34 03	1878 080 033
016 250 35 03	1878 080 034
016 250 36 03	1878 080 034
016 250 37 03	1878 080 034
016 250 40 03	1878 002 735
016 250 41 03	1878 002 735
016 250 42 03	1878 002 735
016 250 43 03	1878 080 037
016 250 44 03	1878 080 037
016 250 45 03	1878 080 033
016 250 46 03	1878 080 034
016 250 47 03	1878 080 031
016 250 50 03	1878 002 735
016 250 58 03	1864 464 031
016 250 81 03	1878 023 931

Vergleichs-Nr. Compare No.	Artikelnummer Article No.
-------------------------------	------------------------------

MERCEDES-BENZ

016 250 82 03	1878 023 931
016 250 83 03	1878 023 931
016 250 92 03	1864 464 031
016 250 94 03	3400 121 501
016 250 95 03	3400 121 501
016 250 96 03	3400 121 501
016 250 99 03	1878 002 023
017 250 00 03	1878 002 023
017 250 03 03	1878 002 024
017 250 04 03	1878 002 023
017 250 05 03	1878 052 842
017 250 06 03	1878 052 842
017 250 09 03	1878 002 024
017 250 11 03	1878 002 024
017 250 13 03	1878 002 023
017 250 17 03	1878 074 641
017 250 18 03	1878 074 641
017 250 22 03	1878 000 615
017 250 25 03	1862 299 032
017 250 32 03	1862 299 032
017 250 33 03	1862 299 032
017 250 35 03	1862 299 032
017 250 35 03	1862 299 032
017 250 36 03	1862 299 032
017 250 40 03	1861 963 033
017 250 59 03	3400 121 501
017 250 60 03	3400 121 501
017 250 61 03	3400 121 501
017 250 67 03	1878 002 732
017 250 68 03	1878 002 732
017 250 69 03	1878 002 732
017 250 74 03	1861 936 142
017 250 84 03	1878 080 033
017 250 87 03	1878 080 034
017 250 90 03	1878 080 031
018 250 11 03	1878 002 024
018 250 13 03	1878 002 024
018 250 17 03	1861 936 142
018 250 19 01	3800 710 002
018 250 20 01	3800 710 003
018 250 20 03	1878 080 034
018 250 35 03	1878 000 205
018 250 37 03	1878 001 070
018 250 45 01	1862 962 002
018 250 51 01	3000 951 111
018 250 59 03	1878 002 023
018 250 60 03	1878 002 024
018 250 80 03	1878 004 832
018 250 87 01	3000 951 111
018 250 88 03	1878 002 643
018 250 89 03	1861 936 142
018 250 91 01	3400 122 801
018 250 92 03	1878 052 842
018 250 93 03	1878 080 037
018 250 94 01	3400 127 701
018 250 94 03	1878 080 034
018 250 95 01	3400 121 201
018 250 95 03	1878 080 033
018 250 96 01	3400 121 301
018 250 96 03	1878 080 033
018 250 97 01	3400 121 501

Vergleichs-Nr. Compare No.	Artikelnummer Article No.
-------------------------------	------------------------------

MERCEDES-BENZ

018 250 98 01	3400 700 414
018 250 99 01	3400 122 801
018 250 99 03	1878 080 033
018 981 25 10	1863 869 012
019 250 00 01	3400 122 801
019 250 01 01	3400 122 801
019 250 02 01	3400 700 415
019 250 04 01	3400 700 416
019 250 04 03	1878 080 031
019 250 05 01	3400 122 801
019 250 08 03	1878 080 037
019 250 13 03	1878 065 131
019 250 22 01	3000 951 784
019 250 32 03	1878 080 033
019 250 33 03	1878 080 037
019 250 34 03	1878 080 037
019 250 35 03	1878 002 023
019 250 36 03	1878 003 662
019 250 37 03	1878 003 657
019 250 38 03	1878 003 657
019 250 42 03	1878 052 842
019 250 48 01	3000 951 824
019 250 52 03	1878 002 024
019 250 53 03	1878 002 023
019 250 55 03	1878 002 732
019 250 56 01	3000 726 001
019 250 56 03	1878 002 731
019 250 57 01	3000 826 901
019 250 58 03	1878 002 732
019 250 59 01	3000 951 785
019 250 59 03	1878 002 023
019 250 60 01	3000 951 205
019 250 61 01	3000 726 001
019 250 61 03	1878 002 019
019 250 62 01	3000 846 501
019 250 64 01	1878 600 560
019 250 64 01	3482 000 462
019 250 65 01	3400 121 301
019 250 66 03	1878 080 034
019 250 68 03	1878 080 037
019 250 82 03	1878 003 784
019 250 87 01	3000 951 112
019 250 91 03	1878 052 842
019 250 94 03	1878 023 931
019 250 95 03	1878 023 831
019 250 96 03	1878 023 931
019 250 97 03	1878 023 931
019 250 99 03	1878 023 831
020 250 00 03	1878 023 831
020 250 02 03	1878 023 931
020 250 03 03	1878 023 931
020 250 11 03	1878 003 784
020 250 17 03	1878 051 801
020 250 19 03	1878 002 732
020 250 31 03	1878 600 560
020 250 40 01	3400 700 416
020 250 43 03	1878 002 731
020 250 44 03	1878 002 732
020 250 45 01	3400 121 601
020 250 46 03	1878 002 732
020 250 47 01	3400 123 001

Vergleichs-Nr. Compare No.	Artikelnummer Article No.
-------------------------------	------------------------------

MERCEDES-BENZ

020 250 48 01	3400 124 101
020 250 49 01	3400 124 001
020 250 49 03	1878 006 101
020 250 50 01	3400 122 601
020 250 51 01	3400 122 901
020 250 52 01	3400 700 411
020 250 53 01	3400 125 001
020 250 54 01	3400 700 417
020 250 56 01	3400 122 801
020 250 58 03	1878 080 034
020 250 59 03	1878 080 033
020 250 67 03	1878 080 033
020 250 74 01	3000 951 188
020 250 76 03	1878 004 232
020 250 85 01	3400 122 801
020 250 86 01	3400 122 801
020 250 87 01	3400 700 415
020 250 89 01	3400 122 801
020 250 89 03	1878 002 732
020 250 90 03	1878 080 037
020 250 91 01	3400 700 415
020 250 93 01	3400 700 415
020 250 93 03	1878 002 023
020 250 94 01	3400 700 446
020 250 94 03	1878 002 024
020 250 95 01	3400 700 416
020 250 97 03	1878 080 031
020 250 98 01	1878 002 024
020 250 98 01	3488 000 102
021 250 05 03	1878 001 070
021 250 06 01	3400 122 801
021 250 06 03	1878 005 805
021 250 06 03	1878 634 022
021 250 07 01	3400 121 501
021 250 08 01	3400 122 801
021 250 10 03	1878 023 931
021 250 11 01	3000 951 111
021 250 12 01	3000 951 112
021 250 13 03	1878 005 165
021 250 19 01	3400 700 446
021 250 20 01	3400 700 446
021 250 20 03	1878 002 019
021 250 21 01	3400 700 446
021 250 21 03	1878 002 019
021 250 22 01	3400 700 446
021 250 22 03	1878 002 019
021 250 25 01	3482 000 464
021 250 26 01	3400 700 397
021 250 27 01	3400 700 397
021 250 27 03	1878 002 731
021 250 30 03	1878 005 165
021 250 33 05	3000 951 112
021 250 34 01	3400 127 701
021 250 35 01	3400 127 701
021 250 36 01	3400 121 201
021 250 37 01	3400 121 201
021 250 37 03	1878 002 732
021 250 38 01	3400 121 301
021 250 38 03	1878 002 732
021 250 39 01	3400 121 301
021 250 39 03	1878 002 731

Vergleichs-Nr. Compare No.	Artikelnummer Article No.
-------------------------------	------------------------------

MERCEDES-BENZ

021 250 40 01	1878 002 731
021 250 40 01	3483 030 031
021 250 41 01	1878 002 731
021 250 41 01	3483 030 031
021 250 42 01	3400 122 801
021 250 43 01	3400 122 801
021 250 44 01	3400 700 415
021 250 45 01	3400 700 415
021 250 46 01	3400 700 415
021 250 47 01	3400 700 415
021 250 48 01	3400 700 468
021 250 49 03	1878 005 165
021 250 52 01	1878 002 731
021 250 52 01	3483 000 258
021 250 53 01	1878 002 731
021 250 53 01	3483 000 258
021 250 54 01	3400 700 446
021 250 55 01	3400 700 446
021 250 56 01	3400 700 416
021 250 57 01	3400 700 416
021 250 59 03	1878 023 931
021 250 60 01	3400 700 415
021 250 60 03	1878 052 842
021 250 61 03	1878 052 842
021 250 62 01	3400 122 801
021 250 63 01	3400 122 801
021 250 63 03	1878 005 165
021 250 64 01	3400 700 415
021 250 64 03	1878 023 931
021 250 65 01	3400 700 415
021 250 65 03	1878 023 931
021 250 66 01	1878 002 024
021 250 66 01	3488 000 102
021 250 66 03	1878 023 831
021 250 67 01	1878 002 024
021 250 67 01	3488 000 102
021 250 67 03	1878 023 831
021 250 68 01	3400 121 501
021 250 68 03	1878 023 931
021 250 72 01	3400 700 446
021 250 73 01	3400 700 446
021 250 75 01	3400 700 355
021 250 76 03	1878 002 019
021 250 77 03	1878 005 165
021 250 78 03	1878 002 732
021 250 82 03	1878 002 731
021 250 83 03	1878 002 731
021 250 84 03	1878 002 019
021 250 86 01	3400 122 801
021 250 86 03	1878 005 165
021 250 86 03	1878 005 165
021 250 87 03	1878 002 019
021 250 88 03	1878 002 732
021 250 89 01	3400 121 201
021 250 89 03	1878 002 732
021 250 90 01	3400 121 301
021 250 92 03	1878 002 732
021 250 93 03	1878 002 732
021 250 94 01	3400 122 801
021 250 95 01	3400 122 801
021 250 96 01	3400 700 415

Vergleichs-Nr. Compare No.	Artikelnummer Article No.
-------------------------------	------------------------------

MERCEDES-BENZ

021 250 97 01	3400 122 801
021 250 97 03	1878 002 019
021 250 98 01	3400 700 446
021 250 99 01	3400 700 446
021 252 32 05	3000 951 111
022 250 09 01	3400 122 801
022 250 11 01	3400 122 801
022 250 13 03	1861 919 134
022 250 14 01	3400 700 415
022 250 15 01	3400 122 801
022 250 15 03	1878 002 019
022 250 16 01	3400 700 446
022 250 17 01	3400 700 415
022 250 20 01	1878 002 731
022 250 20 01	3483 030 031
022 250 23 01	1878 002 731
022 250 23 01	3483 000 258
022 250 26 01	3400 700 446
022 250 30 01	3400 700 468
022 250 32 01	3400 700 416
022 250 32 03	1878 004 232
022 250 33 01	3400 700 416
022 250 36 01	1878 002 731
022 250 36 01	3483 000 139
022 250 38 01	3400 122 801
022 250 39 01	3400 700 415
022 250 43 01	3400 700 355
022 250 44 01	3400 700 355
022 250 48 01	3400 121 501
022 250 49 01	1878 002 024
022 250 49 01	3488 000 102
022 250 52 01	3400 121 501
022 250 55 01	1878 002 731
022 250 55 01	3483 030 031
022 250 56 01	3400 122 801
022 250 57 01	3400 122 801
022 250 58 01	3400 121 201
022 250 59 01	3400 121 201
022 250 59 03	1878 080 033
022 250 60 01	3400 700 397
022 250 61 01	3400 700 397
022 250 61 03	1878 080 037
022 250 62 01	3400 121 301
022 250 63 01	3400 121 301
022 250 81 01	1878 600 560
022 250 81 01	3482 000 462
022 250 81 03	1878 023 931
022 250 82 03	1878 023 931
022 250 84 03	1878 004 232
022 250 85 03	1878 004 232
022 250 87 03	1878 023 831
022 250 88 03	1878 023 831
022 250 89 03	1878 006 637
022 250 97 03	1878 600 560
023 250 06 03	1878 006 101
023 250 15 01	3400 700 534
023 250 16 01	3400 700 534
023 250 17 01	3400 700 533
023 250 18 01	3400 700 533
023 250 60 01	3400 700 609
023 250 61 01	3400 700 609

Vergleichsliste / Cross reference list

Vergleichs-Nr. Compare No.	Artikelnummer Article No.
-------------------------------	------------------------------

MERCEDES-BENZ

023 250 68 01	3400 700 532
023 250 69 01	3400 700 532
023 250 82 01	3000 951 824
023 250 83 01	3000 951 188
023 250 92 01	3400 700 477
024 250 01 01	1878 002 731
024 250 01 01	3483 030 031
024 250 02 01	1878 002 731
024 250 02 01	3483 030 031
024 250 04 01	1878 002 731
024 250 04 01	3483 030 031
024 250 05 01	3400 122 801
024 250 06 01	3400 122 801
024 250 06 03	1878 002 019
024 250 08 01	3400 122 801
024 250 09 01	3400 700 415
024 250 10 01	3400 700 415
024 250 12 01	3400 700 415
024 250 14 01	3400 700 415
024 250 15 01	3400 700 415
024 250 17 01	3400 700 415
024 250 17 03	1878 052 842
024 250 19 01	3400 700 416
024 250 21 01	1878 002 731
024 250 21 01	3483 000 258
024 250 21 03	1878 052 842
024 250 22 01	1878 002 731
024 250 22 01	3483 000 258
024 250 22 04	3400 700 446
024 250 24 01	1878 002 731
024 250 24 01	3483 000 258
024 250 25 01	3400 700 446
024 250 26 01	3400 700 446
024 250 28 01	3400 700 446
024 250 29 01	3400 700 416
024 250 30 01	3400 700 416
024 250 32 01	3400 700 416
024 250 34 01	1878 002 731
024 250 34 01	3483 000 139
024 250 37 01	3400 700 415
024 250 38 01	3400 700 415
024 250 40 01	3400 700 415
024 250 41 01	1878 002 024
024 250 41 01	3488 000 102
024 250 42 01	3488 000 102
024 250 4201	1878 002 024
024 250 44 01	1878 002 024
024 250 44 01	3488 000 102
024 250 45 01	3400 121 501
024 250 46 01	3400 121 501
024 250 48 01	3400 121 501
024 250 49 01	3400 121 501
024 250 51 01	3400 700 355
024 250 52 01	3400 700 355
024 250 56 01	3400 700 468
024 250 57 01	3400 700 468
024 250 72 03	1878 007 185
024 250 73 03	1878 007 185
024 250 74 01	1878 002 731
024 250 74 01	3483 030 031
024 250 75 01	3400 122 801

Vergleichs-Nr. Compare No.	Artikelnummer Article No.
-------------------------------	------------------------------

MERCEDES-BENZ

024 250 97 03	1878 006 173
025 250 23 01	3400 127 701
025 250 25 01	3400 127 701
025 250 39 03	1878 002 731
025 250 43 03	1878 005 165
025 250 44 03	1878 002 732
025 250 45 03	1878 002 732
025 250 46 03	1878 002 732
025 250 47 03	1878 002 732
025 250 70 01	3000 951 188
025 250 83 01	3000 951 112
025 250 84 01	3400 122 801
025 250 85 01	3400 122 801
025 250 87 01	3400 700 355
026 250 26 01	3400 700 535
026 250 27 01	3400 700 535
026 250 36 01	3400 122 801
026 250 37 01	3400 700 446
026 250 41 01	3400 700 415
026 250 42 01	3400 700 415
026 250 43 01	3400 122 801
026 250 44 01	3400 122 801
026 250 45 01	3400 122 801
026 250 46 01	1878 002 731
026 250 46 01	3400 700 615
026 250 46 01	3483 030 031
026 250 47 01	1878 002 731
026 250 47 01	3483 030 031
026 250 48 01	3400 700 468
026 250 49 01	3400 122 801
026 250 50 01	1878 002 731
026 250 50 01	3483 000 258
026 250 51 01	3400 700 446
026 250 52 01	3400 700 446
026 250 53 01	3400 122 801
026 250 54 01	3400 700 416
026 250 55 01	3400 700 416
026 250 56 01	3483 000 139
026 250 57 01	1878 005 165
026 250 57 01	3483 000 461
026 250 58 01	1878 002 731
026 250 59 01	1878 005 165
026 250 59 01	3483 000 461
026 250 64 01	3400 700 415
026 250 65 01	3400 700 415
026 250 66 01	1878 002 731
026 250 66 01	3483 030 031
026 250 67 01	3400 700 468
026 250 68 01	3400 122 801
026 250 69 01	3400 122 801
026 250 70 01	1878 002 731
026 250 70 01	3483 000 258
026 250 78 01	3400 700 355
026 250 79 01	3400 700 355
026 250 81 01	3400 700 355
026 250 83 01	1878 002 019
026 250 83 01	3488 000 102
026 250 84 01	1878 002 019
026 250 84 01	3488 000 102
026 250 85 01	3400 700 355
027 250 02 01	3400 700 446

Vergleichs-Nr. Compare No.	Artikelnummer Article No.
-------------------------------	------------------------------

MERCEDES-BENZ

027 250 04 01	3400 700 416
027 250 37 01	3400 700 530
027 250 38 01	3400 700 530
027 250 39 01	3400 700 531
027 250 40 01	3400 700 531
027 250 42 01	3400 700 529
102 980 03 15	1863 869 010
102 981 01 25	1863 869 010
115 980 00 15	1863 869 010
115 980 01 15	1863 869 010
121 250 01 04	1881 059 208
121 250 02 04	1881 059 208
121 250 03 04	1881 059 208
136 250 00 04	1881 059 208
136 250 04 03	1861 123 236
136 250 05 03	1861 123 236
180 250 03 03	1861 123 236
180 250 03 04	1881 059 208
180 250 04 04	1881 059 208
180 250 06 04	1881 059 208
180 250 07 04	1881 059 208
187 250 05 03	1861 123 236
303 250 00 05	1861 034 147
304 250 01 04	1881 039 532
304 252 00 05	1861 034 147
305 250 00 15	3151 094 041
305 250 06 15	3151 094 041
308 250 00 04	1882 205 234
312 250 13 15	3151 095 043
317 250 02 04	1881 041 656
317 250 04 03	1878 000 104
319 250 03 03	1861 123 236
319 250 04 03	1861 123 236
319 250 06 03	1861 123 236
319 250 07 03	1861 123 236
319 250 09 03	1861 123 236
319 250 10 03	1861 123 236
319 250 13 03	1861 123 236
320 250 00 15	3151 000 529
327 250 01 15	3151 094 041
327 250 11 15	3151 094 041
330 250 00 04	1881 039 532
340 250 02 15	3151 095 043
343 254 00 10	3151 000 529
344 250 72 03	1878 000 104
345 250 70 04	1882 166 737
345 250 74 03	1861 303 248
345 250 75 03	1861 303 248
350 250 70 04	1882 301 239
352 250 01 15	3151 095 043
352 250 05 15	3151 095 043
364 250 70 03	1861 470 234
371 250 71 03	1878 026 431
381 250 04 15	3151 044 031
442 030 05 05	3421 601 012
442 030 19 05	3421 601 012
443 250 00 15	1863 837 002
443 250 00 15	1863 855 000
457 030 06 05	3421 601 050
457 030 13 05	6594 000 079
457 030 21 05	6594 000 079

Vergleichs-Nr. Compare No.	Artikelnummer Article No.
-------------------------------	------------------------------

MERCEDES-BENZ

457 030 23 05	6594 000 079
457 030 26 05	6594 000 079
457 030 32 05	6594 000 079
457 030 38 05	6594 000 079
457 030 43 05	6594 000 079
457 030 44 05	6594 000 079
541 030 01 05	3421 601 016
541 030 03 05	6594 000 080
541 030 07 05	6594 000 080
541 030 08 05	6594 000 080
541 030 11 05	6594 000 080
541 030 12 05	6594 000 080
543 030 08 05	6594 000 080
601 030 10 05	2294 000 767
601 030 15 05	2294 000 767
601 030 16 05	2294 000 767
601 030 17 05	2294 000 767
602 030 21 05	2294 000 525
602 030 23 05	2294 000 525
608 250 00 03	1861 421 032
608 250 00 15	3151 270 602
611 030 04 05	2294 001 744
611 030 10 05	2294 001 744
611 030 14 05	2294 001 744
611 030 16 05	2294 001 744
611 030 17 05	2294 001 744
631 250 00 04	3082 191 032
631 250 01 15	3151 198 031
631 250 02 04	3082 191 032
631 250 03 03	1862 375 031
631 250 03 04	3082 191 032
631 250 03 15	3151 198 031
631 250 04 03	1862 375 031
631 250 04 04	3082 191 032
631 290 00 12	6284 600 111
631 293 02 38	3074 600 205
639 290 00 12	6284 605 008
639 290 01 12	6284 605 008
646 030 01 05	2294 001 744
646 030 04 05	2294 001 744
646 030 05 05	2294 000 834
646 030 06 05	2294 001 744
646 030 08 05	2294 000 834
646 030 09 05	2294 000 834
646 030 13 05	2294 000 835
646 030 21 05	2294 000 835
651 030 31 05	2294 000 994
651 030 40 05	2294 000 994
651 030 51 05	2294 000 994
661 250 30 15	3151 000 206
668 990 00 12	1874 000 006
668 990 00 12	1874 000 006
684 250 40 15	3151 000 020
684 254 40 20	3163 030 100
685 250 04 03	1878 001 939
690 250 74 03	1878 000 615
695 250 70 03	1861 777 043
906 030 08 59	3421 601 069
906 030 30 05	3421 601 049
906 030 37 05	3421 601 049
906 030 55 05	3421 601 049

Vergleichs-Nr. Compare No.	Artikelnummer Article No.
-------------------------------	------------------------------

MERCEDES-BENZ

906 030 66 05	3421 601 049
906 290 01 12	6284 605 004
906 290 02 12	6284 605 004
MITSUBISHI	
MB012597	6284 600 160
MB555143	6284 600 160
MB555145	6284 600 160
MB919426	1862 862 002
MB919427	1878 634 029
MB937201	1862 851 002
MB937202	1862 851 002
MB937204	1862 862 002
MB937230	1878 600 827
MD700257	3151 830 001
MD701167	1878 600 827
MD701191	1878 600 827
MD701193	1878 600 827
MD701194	1878 600 827
MD701195	1878 600 827
MD701196	1878 600 827
MD701221	3082 833 001
MD701225	3082 833 001
MD701283	1863 805 001
MD703180	3082 881 001
MD703181	3082 881 001
MD703270	3151 831 001
MD705097	1878 600 827
MD710118	1878 634 029
MD710325	1862 862 002
MD710634	3082 931 001
MD710840	1878 600 827
MD713194	1878 600 827
MD713293	1862 862 002
MD714299	1862 862 002
MD714370	1862 851 002
MD714707	1878 600 827
MD714710	3082 881 001
MD715522	1862 862 002
MD717085	1862 862 002
MD717086	3082 936 001
MD718824	1862 851 002
MD719469	3151 600 525
MD719548	1878 600 827
MD720345	1878 600 827
MD720684	3082 931 001
MD720846	1862 862 002
MD721341	3082 881 001
MD723544	3082 936 001
MD723564	3082 881 001
MD723846	1878 600 827
MD723861	1862 862 002
MD723868	1878 600 827
MD723882	1878 634 029
MD723883	1878 634 029
MD724119	3082 931 001
MD724426	3082 931 001
MD724736	3082 931 001
MD724823	1862 851 002
MD726558	1878 600 827
MD726559	1878 600 827

Vergleichs-Nr. Compare No.	Artikelnummer Article No.
-------------------------------	------------------------------

MITSUBISHI

MD727503	1878 600 827
MD727685	1862 862 002
MD728702	1878 634 029
MD728703	1862 862 002
MD729517	1862 851 002
MD729541	3082 881 001
MD729960	1878 600 827
MD730108	6283 600 156
MD730980	1878 634 029
MD731406	1862 862 002
MD731447	1862 851 002
MD732402	3082 881 001
MD732504	1878 634 029
MD732533	3082 881 001
MD732563	3082 881 001
MD732565	3082 881 001
MD734788	3082 881 001
MD735732	3082 881 001
MD735733	3082 881 001
MD735897	1878 634 029
MD735916	1878 634 029
MD735959	1862 862 002
MD736203	1878 634 029
MD736589	1862 862 002
MD736820	1878 634 029
MD741646	3082 936 001
MD742211	1862 862 002
MD742365	1878 634 029
MD742366	1878 634 029
MD742683	1878 634 029
MD742684	1878 634 029
MD742685	1878 634 029
MD743271	3082 833 001
MD743616	1878 600 827
MD745273	3082 881 001
MD747829	3082 881 001
MD749759	3082 881 001
MD749760	3082 881 001
MD770039	3082 833 001
MD771329	1878 600 827
MD771331	1878 600 827
MD786589	1862 862 002
MD801221	3082 833 001
MD802071	3082 833 001
MD802072	3082 833 001
MD802080	1878 600 827
MD802081	1878 600 827
MD802082	1878 600 827
MD802083	1878 600 827
MD802086	1878 600 827
MD802090	3082 881 001
MD802092	3082 881 001
MD802110	3082 931 001
MD802111	3082 936 001
MD802112	3082 936 001
MD802120	1862 862 002
MD802121	1862 862 002
MD802122	1862 862 002
MD802123	1862 862 002
MD802128	1862 862 002
MD802129	1862 862 002

Vergleichsliste / Cross reference list

Vergleichs-Nr. Compare No.	Artikelnummer Article No.	Vergleichs-Nr. Compare No.	Artikelnummer Article No.	Vergleichs-Nr. Compare No.	Artikelnummer Article No.
MITSUBISHI		NEOPLAN		NEOPLAN	
MD802130	1862 851 002	0401.112.00	3482 051 131	0421.317.00	1861 470 234
MD802131	1862 862 002	0401.113.00	3482 002 234	0421.318.00	1878 086 941
MD802133	1862 862 002	0401.113.00	3482 002 234	0421.320.00	1878 086 941
MD802180	1878 600 827	0401.113.01	1878 001 070	0421.321.00	1878 003 657
MD802200	1862 851 002	0401.113.05	1878 001 077	0421.323.00	1878 005 805
MD802201	1862 851 002	0401.115.01	1878 000 968	0421.323.00	1878 634 022
MD802202	1862 851 002	0401.116.10	3151 108 031	0421.324.00	1878 004 832
MD937201	1862 851 002	0401.117.000	3482 124 532	0421.327.00	1878 085 742
ME581119	3151 600 525	0401.145.00	1861 410 047	0421.327.10	1878 080 031
MN110709	1862 851 002	0401.149.00	1878 000 104	0421.330.00	1878 000 957
MN110712	1862 862 002	0401.150.00	1878 002 706	0421.332.00	1878 001 152
MN110713	1862 862 002	0401.151.00	1878 001 154	0421.333.00	1878 001 152
MR111433	1878 634 029	0401.152.10	1861 777 037	0421.342.00	1878 005 805
MR145801	1878 634 029	0401.155.00	1861 923 032	0421.342.00	1878 634 023
MR176337	1878 634 029	0401.155.00	1878 001 152	0421.346.00	3482 000 463
MR195689	3151 600 525	0401.170.10	3482 124 522	0421.347.10	1878 080 033
MR196313	1878 634 029	0401.172.00	3151 000 515	0421.354.00	1878 080 033
MR246672	1862 862 002	0401.174.27	1863 100 030	0421.354.00	1878 080 033
MR276980	1862 862 002	0401.174.73	1863 101 100	0421.503.00	3151 186 001
MR276981	1862 862 002	0401.175.00	3151 119 001	0421.505.00	3151 202 002
MR290740	1862 862 002	0401.191.00	1861 911 232	0421.509.00	3151 000 958
MR305779	1862 862 002	0401.192.00	3151 000 395	0421.517.00	3151 000 419
MR305948	1862 862 002	0401.20264	1861 303 248	11000033	3151 000 375
MR317024	1862 851 002	0401.202.68	1861 206 211	11009713	1878 002 706
MR331291	3082 881 001	0401.202.83	1881 039 531	11009717	3482 124 516
MR357709	1878 634 029	0401.202.89	1882 252 331	11009718	1878 002 706
MR430585	3151 600 525	0401.202.90	3482 124 541	11009721	3482 002 234
MR534301	1862 862 002	0401.400.00	3082 156 031	11009721	3482 002 234
MR980566	6283 600 156	0401.403.00	1882 305 131	11009727	3482 124 532
RL210109	3000 205 001	0401.404.01	3082 190 031	11009728	3482 124 533
RL210112	3000 199 001	0401.406.00	3482 008 038	11009733	1878 001 070
RL210113	3000 951 422	0401.410.00	1861 574 132	11009734	3151 000 515
RL210114	3000 264 001	0401.412.00	1861 571 236	11009747	3151 119 001
RL210115	3000 263 001	0401.414.00	1861 421 032	11009755	1861 577 037
RL210120	3000 486 001	0401.423.00	1861 777 037	11009760	3082 156 031
		0401.423.00	1861 777 041	11009848	3151 069 131
NEOPLAN		0401.423.01	3482 060 233	11009848	3151 069 131
N10106-8881	1878 085 641	0401.423.01	3482 060 233	11009965	3482 119 031
N101100-9968	3488 017 410	0401.424.41	1878 003 657	11009966	1882 342 134
N1011009971	3482 083 032	0401.434.01	1805 042 000	11009967	1888 055 247
N1011009972	3482 083 118	0401.451.00	1878 003 238	11009968	3488 017 410
N1011009996	1878 005 805	0421.000.00	1882 301 238	11009971	3482 083 032
N1011009996	1878 634 022	0421.000.00	3482 124 541	11009972	3482 083 118
N101101-0036	3151 186 001	0421.003.00	3482 000 953	11009977	3482 017 035
N10116-8876	6594 000 080	0421.003.00	3482 051 131	11009979	3482 081 232
0101.110.06	3151 110 031	0421.006.00	1888 042 009	11009981	3482 062 035
0401.101.00	1882 301 239	0421.007.00	3482 017 033	11009985	3482 083 032
0401.101.10	1878 002 706	0421.009.00	3482 018 132	11009986	3482 083 032
0401.101.11	1878 002 706	0421.009.00	3482 119 031	11009989	1862 123 131
0401.101.21	1878 002 706	0421.010.00	1882 342 134	11009990	1862 122 132
0401.103.00	1882 302 131	0421.010.0099	1882 342 134	11009993	1878 086 941
0401.105.00	1882 311 131	0421.014.00	3482 083 113	11009994	1878 003 657
0401.106.00	1881 041 656	0421.015.00	3482 002 234	11009996	1878 005 805
0401.107.00	3482 124 516	0421.016.00	3488 017 410	11009996	1878 634 022
0401.108.00	1882 342 134	0421.018.00	3482 083 032	11009997	1878 004 832
0401.108.01	1888 042 009	0421.019.00	3482 083 118	11010000	1878 004 832
0401.109.00	3482 001 234	0421.020.00	3482 017 035	11010002	1878 085 742
0401.109.00	3482 119 034	0421.0311.00	1862 123 131	11010003	1878 080 033
0401.110.00	3482 006 036	0421.0353.00	1878 080 034	11010004	1862 506 131
0401.110.0099	3482 006 036	0421.301.00	1861 777 037	11010005	1878 080 031
0401.112.00	3482 000 953	0421.306.00	1878 000 968	11010012	1878 003 658

Vergleichs-Nr. Compare No.	Artikelnummer Article No.
-------------------------------	------------------------------

NEOPLAN

11010013	1878 085 641
11010013	1878 085 641
11010031	1878 080 034
11010032	1878 080 033
11010036	3151 186 001
11010038	3151 202 002
11010039	3151 000 547
11010042	3151 000 157
11060226	1878 004 832
11068876	6594 000 080
11068877	6594 000 124
11068881	1878 085 641
110688875	6594 000 079
11079828	1878 080 037
11079830	1878 004 832
11079872	1878 080 033
14008832	1878 003 657
20268	1861 206 211
20275	1878 001 070
20276	1878 000 105
20278	1878 002 706
20279	1878 001 136
20280	1878 003 657
20281	1878 002 706
20283	1881 039 531
20285	1881 041 656
20285	1881 041 656
20289	1882 252 331
20291	1882 311 131
20292	1882 302 131
20293	1882 301 239
20294	3482 124 516
20295	1882 342 134
20296	1882 301 238
20296	3482 124 541
20297	1882 301 239

NISSAN

16100147-0	3082 956 001
16200147-1	3082 956 001
16200147-2	3082 956 001
16205050-0	3082 956 001
2117 3125	1878 003 867
21173118	3482 000 552
21173120	3482 000 553
21173127	1878 006 129
21173129	3488 000 159
21173130	1878 003 768
21465240	6482 000 155
21581661	1878 006 129
21593956	1878 006 129
30001-F3729	3000 951 373
30001-9X426	3000 951 373
30001-9X430	3000 951 373
30502-69F10	1863 600 116

**ÖSTERREICHISCHE
AUTOMOBILFABRIK (ÖAF)**

81.30301.0228	1878 001 152
81.30301.0250	1861 911 232
81.30301.0260	1861 841 132
81.30301.0261	1862 219 031

Vergleichs-Nr. Compare No.	Artikelnummer Article No.
-------------------------------	------------------------------

**ÖSTERREICHISCHE
AUTOMOBILFABRIK (ÖAF)**

81.30301.0265	1861 526 046
81.30301.0270	1861 876 134
81.30301.0274	1862 244 032
81.30301.0279	1878 001 077
81.30301.0284	1878 000 957
81.30301.0288	1861 777 037
81.30301.0288	1861 777 041
81.30301.0291	1878 002 706
81.30301.0293	1878 001 144
81.30301.0293	1878 001 147
81.30301.0299	1862 303 031
81.30301.0306	1878 005 367
81.30301.0327	1878 004 832
81.30301.0342	1878 001 154
81.30301.0343	1878 002 706
81.30301.0351	1862 364 133
81.30301.0355	1862 441 131
81.30301.0355	1878 080 034
81.30301.0364	1862 441 131
81.30301.0364	1878 080 034
81.30301.0376	1862 441 131
81.30301.0376	1878 080 034
81.30301.0377	1878 080 031
81.30301.0380	1862 438 032
81.30301.0381	1862 441 131
81.30301.0381	1878 080 034
81.30301.0382	1862 441 131
81.30301.0382	1878 080 034
81.30301.0385	1862 441 131
81.30301.0385	1878 080 034
81.30301.0386	1862 441 131
81.30301.0386	1878 080 034
81.30301.0388	1862 441 131
81.30301.0388	1878 080 034
81.30301.0459	1878 080 034
81.30301.9381	1862 441 131
81.30301.9381	1878 080 034
81.30305.0056	1882 209 335
81.30305.0079	1882 302 131
81.30305.0099	3482 032 331
81.30305.0109	3482 006 036
81.30305.0112	3482 008 110
81.30305.0113	1882 342 134
81.30305.0114	1882 304 237
81.30305.0120	3482 017 033
81.30305.0123	1882 346 131
81.30305.0124	1882 342 134
81.30305.0137	1882 342 135
81.30305.0158	3482 083 032
81.30305.0161	3482 008 141
81.30305.0162	3482 060 132
81.30305.0163	3482 017 035
81.30305.0164	1888 015 346
81.30305.0170	1882 017 131
81.30305.0172	3482 085 034
81.30305.0178	3482 078 133
81.30305.0184	3482 093 032
81.30305.0186	3482 102 031
81.30305.0187	3482 102 031

Vergleichs-Nr. Compare No.	Artikelnummer Article No.
-------------------------------	------------------------------

**ÖSTERREICHISCHE
AUTOMOBILFABRIK (ÖAF)**

81.30305.0189	3482 062 035
81.30305.0190	3482 086 132
81.30305.0191	3482 083 032
81.30305.0192	3488 017 333
81.30305.0193	3482 083 032
81.30305.0197	3482 114 031
81.30305.0198	3482 000 467
81.30305.0226	3482 114 031
81.30305.9193	3482 083 032
81.30401.7009	1882 110 532
81.30550.0040	1863 009 100
81.30550.0049	3151 000 515
81.30550.0050	3151 000 395
81.30550.0052	3151 000 512
81.30550.0054	3151 000 958
81.30550.0056	3151 067 032
81.30550.0079	3182 005 231
81.32412.0003	3151 032 341
82.30301.0044	1878 022 841
82.30305.0020	1888 042 009
84.30301.0005	1878 065 131

RENAULT TRUCKS

0000 068 816	1864 509 041
0000 069 816	1864 509 041
0000 075 288	3482 124 534
0000 115 916	1864 509 041
0000 165 103	1864 509 041
0000 165 155	1864 497 042
0000 165 655	1864 497 042
0000 165 659	1864 509 041
0001 140 427	3100 000 081
0001 140 732	3482 037 141
0001 140 733	1878 000 960
0001 141 034	1878 001 138
0001 141 035	3151 000 515
0001 144 060	1878 022 841
0001 150 513	1878 000 960
0001 151 423	1878 022 841
0001 151 855	3151 270 341
0001 151 856	1878 001 729
0001 151 857	3482 124 041
0001 152 310	1878 020 241
0001 154 566	1878 020 241
0003 272 816	3499 373 055
0003 722 816	3499 373 055
0023 521 123	1864 509 041
0023 521 125	1864 509 041
0023 618 017	1864 509 041
0023 618 037	1878 000 104
0023 618 119	3482 042 041
0023 618 122	3100 000 081
0023 618 127	3482 008 033
0023 618 130	1878 000 960
0023 618 131	1864 523 441
0023 618 133	3482 037 141
0023 618 140	3151 111 032
0023 618 153	1878 000 960
0023 618 156	1864 497 043
0023 618 158	1878 634 014

Vergleichsliste / Cross reference list

Vergleichs-Nr. Compare No.	Artikelnummer Article No.
-------------------------------	------------------------------

RENAULT TRUCKS

0023 618 162	1861 577 037
0023 618 190	3482 037 141
0023 618 195	1864 497 042
0023 618 197	1864 523 441
0023 618 210	3482 042 041
0023 818 037	1878 000 104
0943 390 176	1864 509 041
2072 552 5	3482 000 552
2072 552 6	3482 000 553
2073 000 4	3151 000 154
2073 000 7	3100 026 431
2146 523 8	6482 000 155
5000 028 321	3100 008 106
5000 053 508	3482 037 141
5000 055 186	3499 373 055
5000 055 986	3499 373 055
5000 056 638	1850 280 790
5000 057 139	1864 351 005
5000 057 463	1862 353 041
5000 058 221	3151 199 001
5000 059 526	1878 026 241
5000 069 816	1864 509 041
5000 240 864	3151 199 001
5000 240 959	3482 124 534
5000 241 345	1882 261 013
5000 241 347	3151 111 032
5000 243 161	1861 206 211
5000 243 162	1878 001 136
5000 244 067	1878 049 041
5000 249 102	1850 280 790
5000 249 782	3482 097 141
5000 251 317	1861 034 147
5000 251 352	1882 110 532
5000 273 023	1878 005 367
5000 277 211	1878 001 155
5000 278 423	1878 001 155
5000 278 432	1878 001 155
5000 280 176	3482 124 534
5000 280 176	3482 124 541
5000 280 374	1878 005 367
5000 289 010	1878 000 964
5000 293 627	1863 869 041
5000 295 069	1878 001 144
5000 295 069	1878 001 147
5000 295 253	3400 116 601
5000 295 254	3400 116 601
5000 295 255	3400 116 801
5000 295 256	3400 116 801
5000 295 408	1878 005 367
5000 296 267	1862 353 041
5000 296 276	1864 509 041
5000 296 325	1864 497 042
5000 297 145	3482 123 441
5000 326 700	3151 082 001
5000 326 766	3151 082 001
5000 404 186	3151 859 001
5000 404 380	1878 001 713
5000 404 672	1850 280 790
5000 404 673	1878 001 713
5000 436 366	3151 270 341
5000 446 366	3151 270 341

Vergleichs-Nr. Compare No.	Artikelnummer Article No.
-------------------------------	------------------------------

RENAULT TRUCKS

5000 455 001	3482 002 234
5000 455 001	3482 002 234
5000 456 366	3151 270 341
5000 456 368	1864 351 005
5000 456 369	1861 577 037
5000 456 388	3482 008 033
5000 534 562	1850 280 790
5000 534 738	3482 037 141
5000 534 846	3151 270 341
5000 534 850	3482 002 233
5000 534 850	3482 002 233
5000 534 850	3482 124 041
5000 534 976	1864 509 041
5000 559 741	1878 000 105
5000 587 571	1878 002 706
5000 589 570	3482 124 534
5000 589 571	1878 002 706
5000 612 839	1864 454 101
5000 613 038	3151 079 031
5000 613 533	1864 454 101
5000 613 602	1864 454 101
5000 613 602	1878 001 729
5000 613 650	3151 199 001
5000 613 690	1898 917 116
5000 652 893	1897 375 775
5000 660 946	1878 027 442
5000 660 956	3482 124 041
5000 660 978	1878 001 729
5000 667 054	1878 020 241
5000 667 267	1878 002 075
5000 670 325	1864 497 042
5000 677 001	1878 027 442
5000 677 007	1878 020 241
5000 677 053	1878 022 841
5000 677 054	1878 027 442
5000 677 055	1878 022 841
5000 677 060	3482 123 441
5000 677 064	1861 577 037
5000 677 072	1861 577 037
5000 677 073	3482 060 233
5000 677 074	1864 454 101
5000 677 075	3151 199 001
5000 677 087	1878 001 729
5000 677 092	3482 097 141
5000 677 095	3482 097 141
5000 677 128	1898 917 116
5000 677 134	1878 020 241
5000 677 135	1878 027 442
5000 677 138	1878 027 442
5000 677 154	1878 020 241
5000 677 160	1898 917 116
5000 677 165	1862 379 031
5000 677 176	1861 577 037
5000 677 178	1861 577 037
5000 677 180	3151 600 544
5000 677 194	3482 092 031
5000 677 196	1878 001 713
5000 677 199	3482 008 033
5000 677 200	1878 027 442
5000 677 208	1882 022 101
5000 677 211	1878 001 727

Vergleichs-Nr. Compare No.	Artikelnummer Article No.
-------------------------------	------------------------------

RENAULT TRUCKS

5000 677 216	1878 049 041
5000 677 221	1878 001 727
5000 677 230	3482 083 044
5000 677 232	3488 017 334
5000 677 243	1878 020 241
5000 677 244	1878 020 241
5000 677 249	1878 026 241
5000 677 250	1878 027 442
5000 677 251	1878 027 442
5000 677 252	1864 497 043
5000 677 254	1878 022 841
5000 677 263	3482 060 233
5000 677 264	1878 001 077
5000 677 267	1878 002 075
5000 677 268	1878 001 729
5000 677 269	1864 523 441
5000 677 276	3100 008 106
5000 677 279	3482 097 141
5000 677 285	1878 022 841
5000 677 295	1862 379 031
5000 677 302	3151 000 285
5000 677 307	3482 094 031
5000 677 309	1897 375 775
5000 677 311	3151 270 341
5000 677 312	1897 376 506
5000 677 313	3100 008 204
5000 677 316	3482 123 243
5000 677 317	3482 083 044
5000 677 323	3482 083 044
5000 677 328	1878 020 241
5000 677 343	1878 020 241
5000 738 593	1864 454 101
5000 783 593	1864 454 101
5000 783 985	1864 497 043
5000 785 114	1878 003 276
5000 785 115	1882 022 101
5000 785 115	1882 022 101
5000 786 263	3151 000 285
5000 786 288	1897 376 506
5000 786 314	3482 002 233
5000 786 314	3482 002 233
5000 787 645	3100 008 106
5000 787 647	3100 008 106
5000 787 648	3482 097 141
5000 787 649	3482 097 141
5000 787 976	1878 002 075
5000 788 292	1878 020 241
5000 788 292	1878 027 442
5000 788 573	3482 124 041
5000 788 792	1878 027 442
5000 789 351	1878 000 104
5000 789 974	3482 002 233
5000 789 974	3482 002 233
5000 789 974	3482 124 041
5000 789 975	3482 124 041
5000 789 976	3482 124 041
5000 790 457	1878 002 075
5000 790 458	1864 523 441
5000 790 518	1864 497 043
5000 790 602	3482 124 041
5000 790 604	3482 060 233

Vergleichs-Nr. Compare No.	Artikelnummer Article No.
-------------------------------	------------------------------

RENAULT TRUCKS

5000 790 604	3482 060 233
5000 790 605	1864 509 041
5000 790 658	1864 523 441
5000 790 959	1878 027 442
5000 790 959	1878 027 442
5000 798 974	3482 060 233
5000 806 462	3151 032 341
5000 807 806	3151 067 032
5000 809 155	3151 199 001
5000 811 908	1864 509 041
5000 819 904	3100 008 106
5000 821 016	3100 008 106
5000 821 053	1878 001 152
5000 821 330	3100 000 081
5000 821 820	1878 000 104
5000 822 147	1878 002 706
5000 822 585	3151 204 001
5000 826 290	3499 373 055
5000 826 295	3482 037 141
5000 826 296	3482 037 141
5000 826 301	3482 042 041
5000 826 314	3482 124 041
5000 826 397	3482 097 141
5000 835 199	3100 008 106
5000 841 290	3499 373 055
5000 841 295	3482 037 141
5000 841 296	3482 037 141
5000 841 300	3482 042 041
5000 841 301	3482 042 041
5000 841 309	1882 110 532
5000 841 312	1882 302 131
5000 841 313	1882 330 032
5000 841 314	3482 002 233
5000 841 314	3482 002 233
5000 841 315	3482 002 234
5000 841 315	3482 002 234
5000 841 397	3482 097 141
5000 841 398	3100 008 106
5000 841 398	3482 097 141
5001 001 621	1878 001 144
5001 001 621	1878 001 147
5001 001 622	3151 000 958
5001 001 623	3151 000 395
5001 001 628	1878 001 152
5001 001 629	1882 302 131
5001 013 872	1882 022 101
5001 014 737	3482 124 041
5001 486 489	3400 700 408
5001 677 232	3488 017 334
5001 811 639	3400 700 444
5001 821 908	3488 017 334
5001 824 450	1878 022 841
5001 824 773	3482 123 243
5001 825 675	3482 083 044
5001 825 689	3100 008 204
5001 825 886	3400 093 031
5001 825 887	3400 093 031
5001 825 889	3488 017 334
5001 825 897	3400 093 031
5001 829 253	3482 000 270
5001 830 115	1878 002 075

Vergleichs-Nr. Compare No.	Artikelnummer Article No.
-------------------------------	------------------------------

RENAULT TRUCKS

5001 830 413	3483 023 001
5001 830 900	3400 116 701
5001 830 905	3400 117 001
5001 830 909	3400 117 101
5001 830 914	3400 116 901
5001 830 917	1850 280 790
5001 830 917	1878 001 713
5001 830 917	3151 859 001
5001 830 920	1897 375 775
5001 830 920	3499 373 055
5001 830 936	3400 117 301
5001 830 942	3400 700 339
5001 830 945	3151 000 285
5001 830 945	3482 037 141
5001 830 948	1864 497 042
5001 830 951	1897 376 506
5001 834 837	3482 060 233
5001 836 428	3400 700 341
5001 836 993	3496 006 000
5001 837 123	3482 083 252
5001 838 967	3400 117 301
5001 843 357	3400 117 631
5001 843 361	3400 117 532
5001 845 014	3400 700 339
5001 845 035	1882 022 101
5001 846 492	3400 123 401
5001 846 505	3400 123 401
5001 846 524	3400 117 202
5001 848 241	3400 700 338
5001 850 289	1878 051 801
5001 850 395	3400 700 337
5001 850 396	3400 700 333
5001 853 640	3400 700 449
5001 858 682	3151 000 144
5001 859 387	3400 700 409
5001 864 270	3151 000 144
5001 865 858	3400 700 409
5001 865 861	3400 700 408
5001 866 091	3400 700 339
5001 866 103	3400 117 101
5001 866 104	3400 117 101
5001 866 297	3400 700 350
5001 866 299	3400 700 351
5001 866 621	1878 004 832
5001 866 621	3151 263 031
5001 866 621	3400 700 485
5001 866 621	3482 123 631
5001 866 623	1878 001 077
5001 866 623	3151 199 001
5001 866 623	3482 060 233
5001 866 625	1864 454 101
5001 866 625	3151 199 001
5001 866 625	3482 060 233
5001 866 891	3400 700 334
5001 867 227	3400 700 399
5001 867 502	3400 700 444
5001 867 644	3482 634 003
5001 868 260	3400 700 444
5001 868 263	3400 700 408
5001 868 264	3400 700 409
5001 868 266	3400 700 338

Vergleichs-Nr. Compare No.	Artikelnummer Article No.
-------------------------------	------------------------------

RENAULT TRUCKS

5001 868 269	3400 700 408
5001 868 271	3400 117 101
5001 868 272	3400 116 601
5001 868 273	3400 700 339
5001 868 279	3400 700 482
5001 868 531	3400 700 470
5001 868 533	3400 700 359
5001 868 537	3400 700 479
5001 872 322	3400 700 466
5001 872 324	3400 700 466
5001 873 287	3151 000 144
5001 875 223	3400 117 532
5001 875 225	3400 700 311
5007 862 86	1897 376 506
5010 244 017	3151 250 231
5010 244 018	1878 002 455
5010 244 023	3482 094 031
5010 244 043	1878 001 729
5010 244 067	1878 049 041
5010 244 077	1878 001 145
5010 244 080	3482 037 141
5010 244 086	3151 000 404
5010 244 091	1878 026 241
5010 244 091	1878 027 442
5010 244 093	3488 017 439
5010 244 094	3488 017 439
5010 244 097	3482 083 252
5010 244 101	3482 115 031
5010 244 119	1878 039 631
5010 244 142	3482 083 044
5010 244 144	1861 577 037
5010 244 144	1878 000 611
5010 244 184	1878 020 241
5010 244 199	1897 375 775
5010 244 202	3151 250 231
5010 244 203	3482 083 252
5010 244 204	3151 000 404
5010 244 213	1862 438 032
5010 244 225	3151 278 941
5010 244 242	1878 001 145
5010 244 256	1878 020 241
5010 244 256	1878 020 241
5010 244 265	3482 083 252
5010 244 301	3482 123 631
5010 244 304	3488 017 442
5010 244 310	3482 124 041
5010 244 324	1878 026 241
5010 244 379	1878 020 241
5010 244 379	1878 020 241
5010 244 384	1878 020 241
5010 244 390	3151 263 031
5010 244 404	1878 002 075
5010 244 412	1878 020 241
5010 245 267	3400 700 444
5010 245 445	1878 049 041
5010 245 447	1878 026 241
5010 245 448	1878 020 241
5010 245 457	3151 274 131
5010 245 703	1878 039 631
5010 245 896	1878 002 072
5010 245 921	3151 274 131

Vergleichsliste / Cross reference list

Vergleichs-Nr. Compare No.	Artikelnummer Article No.
-------------------------------	------------------------------

RENAULT TRUCKS

5010 452 025	3151 262 031
5010 452 026	1862 379 032
5010 452 304	3151 270 341
5010 452 422	3482 634 003
5010 452 507	1878 026 241
5010 452 572	1878 001 145
5010 545 582	3482 000 691
5010 545 671	3482 123 631
5010 545 676	3151 262 031
5010 545 831	1878 634 034
5010 545 836	3482 000 246
5010 545 851	1878 003 968
5010 545 852	3482 083 034
5010 545 988	3151 000 752
5010 613 114	3151 000 809
5010 613 123	3488 000 122
5010 613 151	1878 634 034
5010 613 228	3400 700 444
5010 613 657	1878 004 832
5010 613 658	1878 003 968
5010 613 659	3482 634 004
5010 613 741	1862 379 032
5010 622 204	1863 869 039
5010 639 033	3151 600 529
5010 639 242	3400 700 444
5010 837 119	3482 083 252
5430 001 154	3482 042 041
5430 013 403	1878 020 241
5430 013 704	3482 037 141
5430 120 506	1878 020 241
5516 021 252	3482 008 033
5516 021 253	3482 008 033
5516 021 260	1861 577 037
5516 021 262	1864 454 101
5516 021 264	1864 454 101
5516 021 267	3151 199 001
5516 021 432	1861 577 037
5516 021 433	1861 577 037
5800 207 033	3151 000 958
5800 207 047	1878 001 144
5800 207 047	1878 001 147
5800 207 048	1878 001 152
5800 207 052	3482 124 534
5800 208 580	3482 124 534
5800 208 581	3482 124 534
7000 736 850	3151 859 001
7403 192 219	3151 000 154
7420 512 915	1863 869 037
7420 702 2	3483 034 042
7420 707 020	3483 034 043
7420 707 022	3483 034 042
7420 707 024	1878 000 634
7420 707 025	1878 006 129
7420 725 523	1878 006 129
7420 725 524	1878 003 867
7420 730 004	3151 000 154
7420 730 007	3100 026 431
7420 730 008	1878 001 215
7420 811 639	3151 600 529
7420 811 639	3400 700 444
7420 812 085	3482 000 553

Vergleichs-Nr. Compare No.	Artikelnummer Article No.
-------------------------------	------------------------------

RENAULT TRUCKS

7420 812 086	3482 000 552
7420 812 087	6482 000 155
7420 813 974	3482 114 031
7420 927 461	3488 017 439
7420 927 842	1862 379 032
7420 959 262	1878 634 034
7420 981 951	3482 634 003
7420 994 737	1878 006 129
7420 998 835	3151 274 131
7421 074 314	3482 634 004
7421 076 710	1878 004 832
7421 134 335	3482 000 552
7421 188 863	3151 000 752
7421 222 008	3482 114 031
7421 235 549	3483 000 348
7421 235 560	3488 000 159
7421 235 561	1878 003 768
7421 320 929	6482 000 155
7421 371 121	3483 000 348
7421 465 238	6482 000 155
7421 580 956	6482 000 155
7421 580 968	6482 000 155
7421 639 030	3482 001 169
7421 639 503	1878 007 046
7421 695 971	1878 006 584
7421 916 049	1878 634 034
7422 078 49	1878 007 170
7485 003 693	3400 700 495
7485 003 694	3400 700 438
7485 003 695	3400 700 311
7485 013 168	6482 000 155
7485 127 008	3151 000 493
7701 011 466	1882 330 032
7701 012 756	1878 005 367
7701 918 023	3482 042 041
8000 243 160	1878 000 104
8201 108 206	3151 600 529
SCANIA	
1102425	3482 119 034
1103478	1878 003 339
1103479	1878 003 339
1103482	1878 003 339
1103489	1878 003 339
1104305	1878 003 238
1108445	1862 328 031
1111147	3483 020 033
1111148	1878 003 066
1111148	1878 063 231
1111149	1862 328 031
1113870	3482 083 039
1115420	3483 019 031
1116682	1878 003 365
1123296	3182 009 938
1210032	1878 063 231
1302903	1861 799 133
1302903	1861 799 133
1304781	1878 062 944
1304781	1878 062 944
1316142	3483 020 033
1318603	1878 062 944

Vergleichs-Nr. Compare No.	Artikelnummer Article No.
-------------------------------	------------------------------

SCANIA

1318603	1878 062 944
1319046	1878 003 365
1321253	1878 003 066
1321253	1878 063 231
1321254	3482 083 039
1321258	1878 003 066
1321258	1878 063 231
1321259	3482 083 039
1321259	3482 083 039
1321280	3483 020 033
1322780	3483 020 036
1323138	1878 003 658
1324883	1878 003 066
1324883	1878 063 231
1327022	3483 024 031
1327023	3483 024 031
1327025	3151 205 202
1332108	1878 003 238
1332619	1878 003 339
1335280	3483 028 031
1335281	3482 112 031
1335282	1862 450 031
1340192	1878 003 066
1340192	1878 063 231
1341683	3180 007 000
1341687	3482 083 150
1349349	1878 043 231
1355282	1862 450 031
1356981	3482 112 031
1356981	3482 112 031
1360231	1878 062 944
1361679	3482 083 039
1365486	3482 083 039
1367172	1878 062 944
1367172	1878 062 944
1368697	1878 003 066
1368697	1878 063 231
1370793	3482 083 039
1370794	3482 083 039
1373275	3483 024 031
1373276	3100 005 202
1382331	3482 083 150
1386931	1878 003 066
1386931	1878 063 231
1387021	1878 062 944
1387021	1878 062 944
1390374	1878 043 231
1393161	3100 008 201
1393161	3100 008 201
1393162	3100 005 202
1393183	3483 020 036
1393184	3483 028 031
1393185	3483 024 031
1393186	3483 020 033
1393332	3182 009 938
1407430	3100 008 201
1407912	3482 124 731
1407913	3482 000 257
1409769	1878 063 231
1412319	1878 003 066
1412319	1878 063 231

Vergleichsliste / Cross reference list

Vergleichs-Nr. Compare No.	Artikelnummer Article No.	Vergleichs-Nr. Compare No.	Artikelnummer Article No.	Vergleichs-Nr. Compare No.	Artikelnummer Article No.
SCANIA		SCANIA		SCANIA	
1413177	1878 043 231	304382	1878 003 238	571220	3482 083 039
1434649	3182 009 938	304384	1878 003 238	571221	3482 083 039
1436695	1878 003 065	304394	1878 003 238	571222	3482 112 031
1444055	3151 000 419	304398	1878 003 238	571223	1862 450 031
1444086	3151 127 031	306600	3482 119 034	571224	1878 043 231
1444110	1878 003 066	306640	3482 124 514	571226	3482 083 039
1444110	1878 063 231	306660	1878 003 339	571227	3482 083 039
1455730	3182 009 938	314820	1861 799 133	571250	1878 003 339
1479574	3482 000 999	315427	3483 019 031	571251	1878 003 365
1479575	1878 003 839	315794	1861 799 133	571252	1878 003 238
1479576	3151 000 151	319827	3482 033 401	571253	1862 328 031
1496761	1878 003 969	324265	1861 799 133	571254	1878 062 944
1499 759	3483 000 259	324460	3482 033 401	571254	1878 062 944
1499769	1878 003 839	324461	3482 033 401	571256	1878 063 231
1499770	3151 000 151	326265	1861 799 133	571261	1861 799 133
1510032	1878 003 066	327557	3482 119 034	571263	1878 003 658
1510032	1878 063 231	328046	1861 799 133	571265	1878 003 238
1513718	3482 000 257	329439	3482 119 034	571268	1878 003 066
1513719	3482 000 251	329440	1878 003 238	571268	1878 063 231
1513720	3482 000 251	360351	1878 003 238	571269	3482 124 731
1521513	3151 000 273	361055	1878 003 238	571270	1878 003 065
1522377	3182 009 938	363671	1861 799 133	571271	1878 003 066
1522424	3482 000 257	363687	3459 004 108	571271	1878 063 231
1523634	1878 003 895	364378	1878 062 944	571279	3483 024 031
1527227	1878 003 969	365063	1878 003 238	571280	1862 328 031
1545062	3100 008 201	365323	1878 003 238	571282	1878 062 944
1547163	3482 000 999	369849	1878 062 944	571282	1878 062 944
1548626	3151 000 273	369849	1878 062 944	571283	1878 063 231
1548627	3482 000 589	382498	3483 020 033	571284	1878 063 231
1571220	3482 083 039	382499	3482 083 039	571285	1878 062 944
1728165	3151 000 151	382576	3482 083 039	571285	1878 062 944
1749123	1878 003 066	383695	3180 001 008	571288	1878 062 944
1749124	1878 003 065	387691	1861 799 133	571289	3482 083 150
1749125	3151 000 151	387692	3488 009 634	571290	1878 062 944
1749126	3496 006 000	388139	1878 003 238	571290	1878 062 944
1763155	3482 000 999	394884	3482 001 234	571291	1878 043 231
1785010	1878 006 370	394884	3482 119 034	571292	1878 063 231
1851631	3151 000 151	524466	3482 119 034	571295	1878 063 231
1854205	3482 000 999	550417	1878 003 238	571296	1878 043 231
1854206	3482 000 589	550501	3400 123 601	571298	3483 024 031
1864707	1878 006 854	550502	3400 123 501	571298	1878 003 066
1898019	1878 003 065	571078	3482 124 514	571300	1878 063 231
1898020	1878 003 895	571079	3482 001 234	571305	1878 003 066
190326	1878 001 138	571079	3482 119 034	571310	1878 003 065
1929397	1878 003 066	571207	3482 124 514	571315	3482 000 257
2023015	3482 000 999	571208	3482 001 234	571316	1878 003 839
2077903	1878 007 253	571208	3482 119 034	571317	1878 003 969
2113295	1878 007 254	571210	3482 001 234	571324	3482 000 257
2163969	3482 000 999	571210	3482 119 034	571447	1878 003 066
234680	3482 124 514	571211	3482 033 401	571802	3400 123 601
234682	3482 119 034	571212	3459 004 108	571803	3400 123 501
247244	1878 003 339	571212	3482 033 401	572943	3400 700 372
259814	1882 110 542	571213	3483 019 031	572944	3400 700 370
264078	1878 003 339	571214	3482 001 234	572945	3400 700 371
264786	3482 119 034	571214	3482 119 034	572949	3400 700 370
264787	1878 003 339	571216	3482 001 234	572950	3400 700 371
274244	1878 003 339	571216	3482 119 034	574852	3482 000 999
282646	3459 004 108	571217	3482 083 039	574858	3482 000 589
282655	3482 033 401	571218	3482 083 039	574864	3482 000 999
294884	3482 119 034	571219	3482 001 234	574867	3482 000 999
294885	1878 003 339	571219	3482 119 034	574903	1878 003 969

Vergleichsliste / Cross reference list

Vergleichs-Nr. Compare No.	Artikelnummer Article No.
-------------------------------	------------------------------

SCANIA

574904	1878 003 895
574905	1878 003 839
574907	1878 006 370
574908	1878 003 065
574909	1878 003 895
6490375	1878 001 138

SISU

130 -503-0321	3151 278 941
130-210-3891	1861 902 032
130-210-3892	1861 902 032
130-210-4341	1878 054 933
130-210-4371	1878 003 968
130-240-3891	3482 021 031
130-240-3892	3482 021 031
130-240-4321	3482 000 209
130-240-4341	3482 123 631
130-240-4351	3482 000 691
130-240-4361	3482 123 631
130-503-0311	3151 027 102
130-510-0031	3151 263 031
139-210-3892	1861 902 032
31068800	3482 046 031
32831400	3482 002 234
62 130-240-4321	3482 083 032

STEYR

004 250 19 04	3082 156 031
120.91.60.721	1805 042 000
133.70.02.10065	1863 837 002
133.70.02.10066	1863 855 000
159.00.01.60901	1861 919 134
161000160004	1882 230 238
161200160903	1882 110 513
1614 160734	1878 005 367
161.40.01.60018	1881 039 531
161.41.60.0181	1881 039 531
161460160902	1882 327 003
179200160902	1878 001 144
189200160904	3482 067 102
19911216007	1878 003 662
199112160905	1878 003 662
199112160907	1878 003 662
209.16.00.03	1881 089 002
209.16.00.05	3151 021 001
209.16.00.06	3151 021 001
209.16.07.21	1805 042 000
209.16.09.01	1881 089 002
337.00.21.0065	1863 837 002
337.00.21.0066	1863 855 000
397.21.0118	3151 082 001
4S2641	1881 039 531
4.712.1.16.001.2	3151 011 001
471221600121	3151 011 001
5 G 2610 B	1882 325 134
527.12.60.10000	3082 121 031
609.E1.60.001	1880 092 415
610.T1.60.004	1864 347 102
610.00.16.0004	1882 230 238
61000160004	1882 230 238
61200160002	1878 001 144
612.00.16.0010	1882 110 513

Vergleichs-Nr. Compare No.	Artikelnummer Article No.
-------------------------------	------------------------------

STEYR

61200160010	1882 110 513
61260160002	1878 001 144
61260160003	1878 001 144
614 160904	1878 005 367
614E160001	1882 327 003
614.00.16.0018	1881 039 531
614.16.00.02	1881 039 531
614.16.00.18	1881 039 531
614.16.0734	1878 005 367
614160734	1878 005 367
614.60.16.0001	1882 261 013
61460160004	1882 327 003
614.60.16.0005	1882 327 003
61460160005	1882 327 003
61500160002	1878 001 152
61560160001	1878 003 661
61560160901	1878 003 661
692.00 16 0009	1862 125 202
692.00.16.0001	3482 063 101
69200160901	3482 063 101
7121160012	3151 011 001
712.11.60.050	3082 007 333
7122160012	3151 011 001
792.00.16.0002	3151 156 003
792.00.16.0006	1878 001 144
792.00.16.0007	3151 156 003
81.30301.0350	1862 438 032
81.30301.0378	1862 506 131
81.30301.0380	1862 438 032
81.30301.0393	1878 044 631
81.30301.0393	1878 044 631
81.30301.0395	1878 044 631
81.30301.0395	1878 044 631
81.30301.9393	1878 044 631
81.30301.9393	1878 044 631
81.30305.0184	3482 093 032
81.30305.0198	3482 000 467
81.30305.0201	3482 120 031
81.30305.0230	3482 000 361
81.30550.0074	3182 005 231
81.30550.0079	3182 005 231
81.30550.0082	3151 253 031
815.00.16.0017	1878 002 706
815.60.16.0003	3482 124 522
815.60.16.0006	3482 124 522
853.03.05.0001	3482 124 522
853.03.05.9001	3482 124 522
892 00 16 0902	3482 067 101
892.00 16 0902	3482 067 102
892.00.16.0001	3482 067 101
892.00.16.0001	3482 067 102
892.00.16.0003	3482 067 101
892.00.16.0003	3482 067 102
892.00.16.0004	1878 001 152
892.00.16.0006	3482 067 102
892.00.16.0007	1878 001 152
990.00.21.0029	3151 111 032
990.00.21.0706	3163 026 100
990.12.21.0078	3151 000 512
991.00.16.0003	1862 304 033
991.12.16.0002	1882 304 208

Vergleichs-Nr. Compare No.	Artikelnummer Article No.
-------------------------------	------------------------------

STEYR

991.12.16.0006	1878 003 661
991.12.16.0007	1878 003 662
991.12.16.0009	1878 003 662
991.14.16.0007	1878 000 968
991.14.16.0011	1888 015 515
991.14.16.0013	3482 118 031
991.14.16.0013	3482 118 031
991.14.16.0017	1878 002 706
991.14.16.0019	1882 342 134
991.14.16.0019	1882 342 134
991.14.16.0020	1878 002 706
991.14.16.0022	3151 186 001
991.14.16.0027	1862 315 101
991.14.16.0028	3482 083 113
991.14.16.0028	3482 083 113
991.14.16.0029	3151 217 001
991.14.16.0030	1878 002 706
991.14.16.0031	1888 015 515
991.14.16.0032	1878 000 968
991.14.16.0033	3151 000 144
991.14.16.0036	1862 315 101
991.14.16.0037	3482 083 113
991.14.16.0738	1878 000 965
991.14.16.0901	3482 118 031
991.14.16.0903	1882 342 134
991.14.16.0916	3482 083 113

TAM

2031033	1880 083 132
2616004	3151 000 395
2616014	3151 000 375
2616632	1880 083 132
2617049	3151 126 031
2618091	1861 600 033
2618559	3151 000 515
2618657	1881 041 656
5024064	1861 600 033
5024072	1882 137 307
5052220	1878 001 074
5095174	1861 034 147
5179629	1878 001 070
5190118	1882 325 134
5196701	3151 068 101
5253497	1878 001 152
5304148	3151 000 515
5516382	1878 001 152
5549485	1882 325 134
5560749	1882 342 134
5579934	1882 342 134
5582684	3482 008 036
5597401	3151 000 395
5599230	3151 000 515
5601006	3482 008 036
5601007	1861 653 132
5601009	3151 199 001
5603773	3482 085 034
5614068	3482 124 534
5614082	3482 017 034
5615592	3482 083 113
5615748	3482 002 234

Vergleichsliste / Cross reference list

Vergleichs-Nr. Compare No.	Artikelnummer Article No.
-------------------------------	------------------------------

TAM

5616891	3482 085 034
5616893	1878 001 154
5618023	3151 000 034
5619162	1882 022 101
5631940	3482 008 038
5645436	3482 017 035
5650301	1878 001 152
5651445	3482 000 461
5654556	1862 506 131
5654557	3482 000 463
5750659	3151 000 419
6345185	3151 011 001
8751-52-51.35	1878 001 074
8751-52-51.36	1881 039 532

TEMSA

13F10-22005-AA	1878 001 709
----------------	--------------

VAN HOOL

VH 140667/3	3151 027 102
100.901.513	1878 002 139
10628942	3151 000 034
10628946	3400 121 601
10628949	3482 000 209
10642776	3151 000 157
10656900	1878 001 136
10664863	3482 119 031
10696404	1878 002 023
107 137 84	1878 086 742
107 206 80	3488 000 108
107 206 99	1878 002 643
107 295 14	3482 124 549
107 876 69	1878 085 641
107 987 81	1888 042 009
10713784	1878 086 742
10725736	1878 080 033
10737529	1878 080 031
10739529	1878 080 031
108 390 52	3482 000 209
10876696	1878 002 139
109 092 66	1878 001 136
109 342 60	1878 086 741
109 458 03	3151 000 034
109 960 15	3151 000 034
1096 8918	3151 000 157
10996001	3151 000 335
11257228	3151 000 335
42026023	1861 653 132
469 5661	1878 000 957
472 4654	3151 127 031
517 974	1878 085 641
518 312	3482 000 246
632 100 080	3482 085 033
632 100 080	3482 085 033
632 100 090	1878 002 955
632 100 100	3151 054 031
632 100 110	1878 001 138
632 100 150	3151 000 515
632 100 200	3482 124 541
632 100 210	1878 002 706
632 100 240	1882 301 239
632 100 270	1882 302 131

Vergleichs-Nr. Compare No.	Artikelnummer Article No.
-------------------------------	------------------------------

VAN HOOL

632 100 340	1882 301 239
632 100 390	3151 108 031
632 100 410	1878 002 955
632 100 440	1882 342 134
632 100 440	1882 342 134
632 100 450	3151 000 375
632 100 470	1861 911 232
632 100 480	3151 000 395
632 100 550	3151 027 102
632 100 570	3151 000 512
632 100 670	3482 085 033
632 100 680	3482 002 234
632 100 680	3482 002 234
632 100 690	1861 777 037
632 100 690	1861 777 041
632 100 700	3151 199 001
632 101 010	3151 000 395
632 101 020	1882 342 134
632 101 030	1882 342 135
632 101 060	1888 042 009
632 101 110	1861 911 232
632 101 220	1878 000 968
632 101 260	1878 086 741
632 101 260	1878 086 741
632 101 320	1861 777 037
632 101 320	1861 777 041
632 101 350	1878 002 706
632 101 360	1878 001 136
632 101 440	1861 777 037
632 101 470	3482 017 035
632 101 600	1862 303 031
632 101 610	3488 017 333
632 101 620	3151 000 034
632 101 630	3151 000 395
632 101 640	1888 042 009
632 101 670	3482 083 113
632 101 670	3482 123 235
632 101 690	1862 302 031
632 101 770	3482 119 031
632 101 780	3482 119 031
632 101 790	1878 003 657
632 101 850	1878 086 741
632 101 850	1878 086 741
632 101 870	1878 086 742
632 101 880	3151 249 001
700 113 365	3151 000 515
700 117 405	3482 118 031
860 212 52	3482 008 033
860 212 52	3482 008 038
920 919 503	3482 083 118

VOLKSWAGEN

TEG 141 165	3151 997 201
T2D 141 025	3482 934 001
0B7 141 671	3182 997 804
0B8 141 671	3182 997 802
000 141 165	3151 248 031
007 141 165 A	3151 600 541
019 141 165	3151 193 041
025 141 025	3082 086 434
025 141 025 A	3082 086 434

Vergleichs-Nr. Compare No.	Artikelnummer Article No.
-------------------------------	------------------------------

VOLKSWAGEN

025 141 025 D	3082 086 434
025 141 025 E	3082 086 434
029 141 025	3082 086 434
029 141 025 A	3082 086 434
029 141 025 B	3082 086 434
029 141 025 B	3082 086 434
029 141 025 C	3082 086 434
034 105 313 A	1863 869 005
034 141 313 A	1863 869 005
035 141 118	3082 919 001
046 105 313 D	1863 869 002
060 105 313 A	1863 869 002
060 105 313 B	1863 869 002
060 105 313 B	1863 869 002
061 141 025	3482 032 331
061 141 025 A	3482 032 331
061 141 025 D	3482 102 031
061 141 025 E	3482 102 031
061 141 025 F	3482 102 031
061 141 025 F	3482 102 031
061 141 025 G	3482 102 031
061 141 031	1861 897 034
061 141 031 A	1861 897 034
061 141 031 B	1861 841 132
061 141 031 C	1861 841 132
061 141 031 D	1861 841 132
061 141 031 E	1862 219 031
061 141 031 F	1861 841 132
061 141 031 H	1861 841 132
061 141 031 K	1861 841 132
061 141 031 L	1862 219 031
061 141 031 M	1862 219 031
061 141 031 N	1862 219 031
061 141 031 P	1862 219 031
062 141 025 A	3082 268 031
062 141 025 A	3082 268 031
062 141 025 B	3082 919 001
062 141 025 E	3000 951 107
062 141 031	1864 528 442
062 141 031 A	1878 994 001
062 141 031 F	3000 951 107
073 141 031	1861 897 034
073 141 031 A	1861 897 034
073 141 031 B	1861 897 034
073 141 031 C	1861 897 034
073 141 031 C	1861 897 034
073 141 031 D	1861 897 034
073 141 031 E	1861 897 034
073 141 031 F	1861 897 034
073 141 031 G	1861 897 034
073 141 031 J	1861 897 034
073 141 031 K	1861 897 034
073 141 031 L	1861 897 034
073 198 141 X	3000 055 006
074 141 025 C	3082 639 402
074 141 025 D	3082 308 043
074 141 025 D	3082 308 043
074 141 025 F	3082 308 043
074 141 025 H	3082 600 522
074 141 025 J	3082 600 522
074 141 025 M	3082 600 509

Vergleichsliste / Cross reference list

Vergleichs-Nr. Compare No.	Artikelnummer Article No.
-------------------------------	------------------------------

VOLKSWAGEN

074 141 032	1864 528 442
074 141 032 B	1878 988 102
074 141 032 E	1878 988 102
076 105 313	1863 869 012
076 141 015 A	3000 951 841
076 141 015 B	3000 951 876
076 141 015 C	3000 951 932
076 141 025	3082 190 031
076 141 025 A	3082 190 031
076 141 025 B	3082 190 031
076 141 025 C	3082 190 031
076 141 031	1878 004 776
076 141 031 A	1878 004 776
076 141 031 B	1878 004 776
076 141 031 C	1878 004 776
076 141 031 D	1878 004 776
076 141 031 E	1878 004 776
076 141 031 F	1878 004 776
076 141 031 G	1878 004 776
076 141 031 H	1878 004 776
076 141 031 J	1878 004 776
076 141 031 K	1878 004 776
076 141 031 L	1878 004 776
076 141 031 M	1878 004 776
076 141 031 N	1878 004 776
076 141 031 P	1861 897 034
076 141 031 P	1861 897 034
076 141 031 R	1878 004 776
076 141 031 S	1878 004 776
076 141 031 T	1878 004 776
076 141 032	1878 004 776
076 141 032 A	1878 004 776
076 141 032 B	3000 951 841
076 198 141 X	3000 055 005
088 141 165	3151 193 041
088 141 165 A	3151 193 041
088 141 165 B	3151 193 041
088 141 165 C	3151 193 041
091 141 165	3151 193 041
091 141 165 A	3151 193 041
091 141 165 B	3151 193 041
091 141 165 D	3151 193 041
111 141 025	1881 065 101
111 141 025	1881 065 101
111 141 025 A	1881 065 101
111 141 025 A	1881 065 101
111 141 025 B	1881 065 101
111 141 025 B	1881 065 101
111 141 025 C	1881 065 101
111 141 025 D	1881 065 101
111 141 025 D	1881 065 101
111 141 025 E	1881 065 101
111 141 025 F	1881 065 101
111 141 025 F	1881 065 101
111 141 025 G	1881 065 101
111 141 025 G	1881 065 101
111 141 025 H	1881 065 101
111 141 025 H	1881 065 101
111 141 031 F	1861 280 136
111 141 031 G	1861 280 136
111 141 165	3151 270 602

Vergleichs-Nr. Compare No.	Artikelnummer Article No.
-------------------------------	------------------------------

VOLKSWAGEN

111 141 165 A	3151 270 602
111 141 165 A	3151 270 602
111 141 165 C	3151 270 602
113 141 165	3151 193 041
113 141 165 A	3151 193 041
113 141 165 B	3151 193 041
113 141 165 C	3151 193 041
113 141 165 D	3151 193 041
2D0 721 261	6283 600 115
2D0 721 261 A	6283 600 115
2D0 721 261 B	6283 600 115
2D0 721 401	6284 600 573
2E0 721 401 C	6284 605 004
2RD 141 031	1878 859 001
2RD 141 031 B	1878 859 001
2SO141025	3483 000 001
2VH 141 031	1878 002 642
211 141 025	1881 065 101
211 141 025 D	1881 065 101
211 141 025 F	1881 065 101
281 721 335 B	3074 003 343
281 721 335 E	3074 003 343
281 721 335 F	3074 003 343
311 141 025	1881 065 101
VOLVO	
1069031	3488 019 032
1069032	3488 019 031
1069033	1862 415 031
1070754	3482 602 008
1071393	3482 602 003
1071544	1878 000 961
1071826	3482 909 001
1071826	3482 909 001
1521 719	3483 000 382
1521246	1862 349 031
1521712	3483 034 034
1521713	3483 034 035
1521714	3488 022 253
1521716	1878 032 331
1521717	1878 002 437
1521718	3482 123 234
1521721	3483 034 033
1521725	3459 018 004
1521726	1878 002 442
1521730	3482 123 235
1524768	1862 530 231
1526023	1888 015 515
1526046	1878 001 082
1526047	1878 001 080
1526199	1861 907 132
1526214	1861 672 033
1526574	3482 026 332
1527029	3482 021 031
1527121	3488 007 631
1527122	1861 907 132
1527123	1861 996 137
1527124	1888 019 445
1527254	3482 026 332
1527255	3459 004 108
1527284	1878 076 031

Vergleichs-Nr. Compare No.	Artikelnummer Article No.
-------------------------------	------------------------------

VOLVO

1527285	1862 974 002
1527307	3482 905 001
1527308	1862 973 002
1527444	3482 021 031
1527445	1878 000 961
1527473	1888 019 542
1527474	1882 250 143
1527475	1859 170 204
1527517	3483 034 032
1527518	1861 988 034
1527519	1861 988 040
1527521	1861 988 040
1527523	1878 001 082
1527524	1878 001 080
1527693	3151 106 041
1527695	3151 105 141
1527909	3488 007 631
1527910	3482 026 332
1527911	1861 996 137
1527912	1861 907 132
1527913	3459 004 108
1652986	1863 869 037
1655151	1862 974 002
1655152	1878 076 031
1655162	1888 019 445
1655163	1878 001 079
1655164	1878 001 083
1655235	1878 000 961
1655287	3151 600 534
1655288	3151 600 533
1655331	3483 034 032
1655332	3488 013 138
1655334	1861 997 137
1655335	1861 996 137
1655342	3482 905 001
1655406	1888 019 445
1655407	1888 019 542
1655408	1888 019 542
1655409	1888 015 515
1655410	1888 015 515
1655412	1859 170 204
1655417	1859 212 000
1655648	1878 001 082
1655649	1878 001 080
1655676	1861 988 034
1655677	1861 988 040
1655677	1861 988 040
1655678	1861 988 040
1655683	3488 007 631
1655684	3482 026 332
1655684	3482 026 332
1655685	3459 004 108
1655685	3459 004 108
1655686	1861 996 137
1655687	1861 907 132
1655688	3474 012 000
1655688	3474 012 001
1655731	3459 000 009
1655738	3482 123 235
1655741	3482 056 031
1655752	3482 123 235

Vergleichsliste / Cross reference list

Vergleichs-Nr. Compare No.	Artikelnummer Article No.
-------------------------------	------------------------------

VOLVO

1655773	1878 000 961
1655822	3483 034 032
1655829	3180 001 008
1655840	3483 014 132
1655841	3483 017 031
1655842	3459 010 101
1655843	3100 026 432
1655875	3488 016 031
1655877	3459 012 131
1655878	1878 087 241
1655878	1878 087 241
1655879	1878 087 241
1655879	1878 087 241
1655884	3482 071 131
1655899	3482 059 031
1667255	3483 034 032
1667256	1861 988 040
1667257	3482 123 235
1667927	1861 996 137
1667928	1878 000 965
1667929	1878 000 968
1667930	1878 001 082
1667931	1878 003 242
1668369	1861 997 137
1668370	1861 996 137
1668371	3488 013 138
1668372	1878 001 082
1668373	1878 001 080
1668375	1862 248 033
1668529	3482 071 131
1668536	3482 123 235
1668537	1878 634 026
1668567	3488 016 031
1668615	3483 034 032
1668616	3482 123 235
1668618	1862 530 231
1668665	3483 022 031
1668666	3482 101 032
1668667	1862 349 031
1668671	1862 530 231
1668672	1878 634 026
1668674	1861 997 137
1668675	1862 248 033
1668676	3488 016 031
1668677	1878 087 241
1668677	1878 087 241
1668678	1878 087 241
1668678	1878 087 241
1668718	1882 226 533
1668718	1882 226 533
1668919	3482 123 234
1668919	3482 123 234
1668921	3100 026 432
1668927	3483 022 032
1668928	3482 101 032
1668929	1878 003 779
1668930	3100 002 549
1668938	3100 002 549
1668980	3488 016 031
1668981	1878 087 241
1668981	1878 087 241

Vergleichs-Nr. Compare No.	Artikelnummer Article No.
-------------------------------	------------------------------

VOLVO

1668982	1878 087 241
1668982	1878 087 241
1668983	1878 634 026
1669116	3483 034 033
1669117	3488 019 031
1669134	3459 016 031
1669135	3488 018 031
1669137	3482 110 031
1669138	1878 002 458
1669141	1862 415 031
1669142	1862 248 033
1669143	3459 017 031
1669144	3482 111 031
1669287	3483 022 031
1669370	3483 034 032
1669371	3488 019 032
1669373	3482 111 032
1669657	3488 018 031
1669821	3488 018 031
1669823	3488 019 031
1669827	3483 034 033
1669828	3483 034 032
1669829	3483 022 032
1669830	3483 022 031
1669832	3100 026 432
1672847	3151 000 163
1672930	3483 022 031
1672931	3483 022 032
1672934	3483 034 032
1672934	3483 034 032
1672934	3483 034 032
1672935	3483 034 033
1672938	3488 019 031
1672940	3488 019 032
1672942	3488 018 031
1672944	3100 026 432
1672945	3151 000 154
1672948	3100 002 549
1673859	1862 530 231
1905274	3151 600 544
20350440	1878 600 557
20366222	1878 001 215
20366269	1878 001 216
20366270	1878 040 334
20366563	1878 001 215
20366567	3483 034 044
20366575	3483 034 045
20366576	3483 034 044
20366591	1878 000 300
20366592	1878 000 635
20366595	1878 000 635
20366765	3483 034 135
20366876	3488 000 024
20376429	1878 021 731
20400400	1878 000 961
20400401	1878 000 961
20400402	1878 600 563
2048 4465	1878 003 869
2048 4465	3482 000 865
2048 4471	1878 003 869
20484461	3482 000 552

Vergleichs-Nr. Compare No.	Artikelnummer Article No.
-------------------------------	------------------------------

VOLVO

20484463	3482 000 553
20484467	1878 003 867
20484468	1878 006 129
20504343	1878 002 139
20504343	3482 000 246
20507752	1878 001 215
20507756	1862 248 033
20507761	1878 001 216
20510799	3482 123 234
20510801	3151 000 163
20510803	1878 001 215
20510805	1878 000 634
20514210	1878 000 961
20514214	1878 600 557
20514365	1878 000 961
20514373	1878 600 557
20525015	1878 006 129
20525018	1878 000 634
20526951	1878 000 300
20566388	1878 003 867
20566389	1878 006 129
20569126	3483 034 033
20569128	3483 034 034
20569130	3483 034 035
20569134	3483 034 042
20569137	3483 034 043
20569139	3483 034 045
20569141	3488 019 032
20569143	3483 027 332
20569145	3488 000 024
20569147	3483 034 135
20569151	3100 026 431
20569153	3100 026 434
20569157	3100 026 432
20569159	3151 000 154
20569174	3151 000 163
20569176	3151 000 218
20571156	3488 000 024
20571158	3488 019 032
20571923	3488 022 253
20571927	3488 018 031
20571945	3180 000 009
20571946	3180 001 008
20575561	3483 034 033
20577448	1878 000 634
2070 8329	1878 003 869
20717563	3488 000 159
20717564	1878 003 768
2072 9071	1878 003 869
20733475	6594 000 120
20733540	3483 000 348
20733546	3483 000 348
20744252	3488 000 159
20748154	3483 000 382
20754422	3483 000 348
20796222	1863 869 039
2080 3129	3482 000 865
20806451	6482 000 155
20806453	3482 000 552
20806454	3482 000 553
20812087	6482 000 155

Vergleichsliste / Cross reference list

Vergleichs-Nr. Compare No.	Artikelnummer Article No.	Vergleichs-Nr. Compare No.	Artikelnummer Article No.	Vergleichs-Nr. Compare No.	Artikelnummer Article No.
VOLVO		VOLVO		VOLVO	
20812540	3482 634 003	267175	3459 004 108	335061	1878 000 961
20812547	3151 000 752	267179	1878 000 961	346319	1882 226 533
20812550	1878 634 034	267181	1882 280 213	346319	1882 226 533
20812688	3151 000 809	267182	1859 212 000	348842	3151 105 141
20812690	1878 026 241	267187	3151 824 005	352221	3151 106 041
20839263	6594 000 120	267221	1878 003 242	354925	1878 001 079
20857090	3482 634 005	267235	1888 019 542	355021	1878 001 079
20877670	1878 634 038	267236	1878 001 082	355022	1882 325 134
20891853	1878 005 284	267237	1878 001 080	355062	3151 824 005
20891854	1878 000 634	267238	1888 015 515	3600663	1882 342 134
20918477	1878 000 634	267240	1888 019 445	3600696	3488 007 631
20994735	1878 006 129	267248	3482 021 031	363724	3482 021 031
21134336	3482 000 552	267249	1878 000 961	364239	1882 280 213
21188868	3151 000 752	267328	1861 672 033	364240	1878 001 083
21260847	6594 000 120	267418	1861 672 033	3807988	1866 000 140
21320923	6482 000 155	267445	1882 280 140	382853	1882 280 213
21320929	6482 000 155	267446	1878 000 968	3886887	1866 000 239
21416133	6594 000 120	267447	1878 000 965	3950706	1878 021 731
21459182	6482 000 171	267490	3482 021 031	3952874	3482 008 244
21465235	6482 000 155	267492	1878 000 961	3952875	1878 021 731
21522835	6594 000 120	3018010	1888 019 445	430123	3082 973 001
21527813	1878 006 129	3018127	1878 000 961	446168	1881 059 208
21539802	1878 006 129	3018128	1861 672 033	4461682	1881 059 208
21580956	6482 000 155	3018129	1888 019 445	5001132	1882 226 533
21580965	6482 000 171	3018130	1878 001 083	5001132	1882 226 533
21580968	6482 000 155	3018131	1878 001 079	5001387	1882 280 213
21580977	6482 000 155	3124470	1878 076 031	5001389	1882 280 213
21581138	1866 000 239	3124471	1862 974 002	5001489	1882 250 143
21587809	1878 006 129	3124472	1878 000 961	5001490	1882 325 134
21587948	1878 006 129	3127465	1862 973 002	5001499	3482 909 001
21587950	1878 006 129	3181801	3482 602 005	5001619	1882 226 533
21593944	1878 006 129	3181802	3482 602 006	5001619	1882 226 533
21593949	1878 006 129	3191766	1878 000 634	5001642	3482 119 032
21615193	3482 001 169	3191767	1878 006 129	5001746	3482 021 031
21615194	1878 007 046	3191991	1878 634 026	5001845	1882 280 140
21635824	3482 000 865	3192200	3483 034 033	5001855	1882 280 140
21648793	3482 001 165	3192201	3483 034 034	5001913	3482 026 332
21695963	1878 006 584	3192202	3483 034 035	5002099	3482 021 031
21844676	1878 007 046	3192203	3488 022 253	5002221	3482 026 332
21844678	1878 007 046	3192205	3488 019 032	5002241	1878 001 082
21858909	3482 000 865	3192206	3483 027 332	5002242	1878 001 082
21934651	6482 000 171	3192208	3488 018 031	5002243	1878 001 080
21934653	6482 000 171	3192209	3100 026 432	5002702	3482 021 031
22078244	1878 007 170	3192209	3482 110 031	5002707	1882 250 143
22078254	1878 007 169	3192210	3483 034 033	5002861	3482 905 001
267005	1888 019 445	3192211	3483 034 032	5002908	1888 019 542
267006	1859 170 204	3192212	3483 022 031	5003005	3482 026 332
267043	1859 212 000	3192213	3483 022 032	5003214	3482 123 235
267142	1888 019 445	3192216	3100 026 434	5003215	3482 123 235
267143	1882 250 143	3192216	3100 026 434	5003216	3482 056 031
267156	3151 106 041	3192217	3151 000 163	5003237	3482 026 332
267158	3151 105 141	3192218	3100 026 431	5003237	3482 026 332
267160	1882 226 533	3192218	3100 026 431	5003295	3482 059 031
267160	1882 226 533	3192219	3151 000 154	5003316	3482 071 131
267161	1861 672 033	3192222	3100 026 432	5003414	3482 123 235
267168	1862 973 002	3192224	3100 002 549	5003464	3482 602 002
267169	3482 909 001	3192224	3100 002 549	5003471	3482 071 131
267171	3482 119 032	3192225	3151 000 218	5003472	3482 123 235
267171	3482 119 032	3192782	3483 034 042	5100001	1878 000 961
267173	3488 007 631	3192783	3483 034 043	5100004	1878 001 079
267174	3482 026 332	3192845	1878 003 779	5100006	1878 001 082

Vergleichsliste / Cross reference list

Vergleichs-Nr. Compare No.	Artikelnummer Article No.
VOLVO	
5100007	1878 001 080
5100057	1878 001 079
5100109	1878 001 079
5430123	3082 973 001
6794389	1862 973 002
6794390	1878 076 031
6794391	1862 974 002
6795044	3482 602 002
6795045	1878 000 961
6797058	3151 600 535
685611	3151 199 001
6856112	3151 199 001
8112101	1878 000 961
8112102	1861 672 033
8112103	1878 001 083
8112104	1878 001 079
8112105	1861 988 034
8112106	1861 988 040
8112107	1861 988 040
8112108	1878 001 082
8112109	1878 001 080
8112110	1861 996 137
8112111	1861 907 132
8112112	1878 000 961
8112113	1861 997 137
8112113A	3100 026 432
8112114	1861 996 137
8112116	1862 973 002
8112117	1878 076 031
8112118	1862 974 002
8112122	1861 996 137
8112123	1878 000 965
8112124	1878 000 968
8112125	1878 001 082
8112126	1878 003 242
8112127	1878 087 241
8112127	1878 087 241
8112128	1878 087 241
8112128	1878 087 241
8112131	1878 000 961
8112134	1878 000 961
8112135	3482 905 001
8112136	1878 000 961
8112136	1882 325 134
8112136	3151 824 005
8112138	1800 125 601
8112139	1878 003 242
8112139	3151 105 141
8112139	3482 119 032
8112140	3400 037 032
8112148	3400 035 032
8112149	1861 988 040
8112149	3482 123 235
8112157	3482 909 001
8112159	1861 988 040
8112159	3482 123 235
8112160	3400 040 032
8112167	1878 001 079
8112167	1878 001 083
8112167	1882 280 140
8112167	3151 106 041

Vergleichs-Nr. Compare No.	Artikelnummer Article No.
VOLVO	
8112168	1878 001 079
8112168	1878 001 083
8112168	1882 250 143
8112168	3151 106 041
8112171	1800 106 033
8112172	3400 032 033
8112173	3400 031 033
8112174	3400 116 501
8112175	3400 030 033
8112186	1878 076 031
8112186	3482 909 001
8112187	3400 116 001
8112189	1862 974 002
8112189	3482 909 001
8112190	3400 116 301
8112191	3400 043 032
8112192	3400 116 501
8112193	1800 125 001
8112194	1878 634 026
8112221	3482 123 235
8112221	3482 123 235
8112283	3482 101 032
8112305	3400 116 201
8112306	3400 037 032
8112307	3400 116 101
8112308	3400 037 031
8112309	1878 076 031
8112310	1862 974 002
8112311	1878 000 961
8112340	1862 349 031
8112539	1862 973 002
8112541	3400 116 001
8112597	3482 101 032
8112598	3482 123 234
8112598	3482 123 234
8112600	1862 415 031
8112601	1862 248 033
8112602	3482 111 031
8112603	3482 110 031
8112604	1878 002 458
8112662	1878 003 779
8112754	1800 107 133
8112768	3400 106 031
8112835	3482 602 003
8112836	1878 000 961
8112839	1862 973 002
8112840	3400 116 001
8112841	1878 076 031
8112842	3400 116 201
8112843	1862 974 002
8112844	3400 116 101
8112845	1878 000 961
8112846	3400 037 032
8112848	3400 037 031
8112924	1862 530 231
8113054	1878 634 026
8113225	1878 634 026
8113237	3482 008 244
8113238	1878 021 731
8113257	1862 530 231
8113463	3483 034 033



Vergleichs-Nr. Compare No.	Artikelnummer Article No.
VOLVO	
8113467	1878 032 331
8113468	1878 002 437
8113511	3482 909 001
8113511	3482 909 001
8113512	3483 034 034
8113513	3483 034 033
8113514	3483 034 035
8113515	3488 022 253
8113525	1878 634 026
8113529	3483 034 033
8113546	3400 035 032
8113547	3400 040 032
8113548	3400 032 033
8113549	3400 043 032
8113550	3400 106 031
8113551	3400 043 032
8113601	3483 022 032
8113658	1878 002 442
8113803	3400 700 301
8113811	3400 127 101
8113812	3400 043 032
8113813	3400 700 401
8113817	1878 600 557
8113818	3482 602 005
8113824	3400 127 201
8113825	3400 127 201
8113894	3483 034 042
8113942	1878 000 961
8113944	1878 600 563
8113946	3488 022 253
8113947	1878 002 437
8113993	1878 002 442
8171426	1878 000 634
8171479	1878 002 442
8171494	3488 022 253
8171496	1878 002 437
8171497	1878 002 442
8172350	3488 000 024
8172354	1878 032 331
8172402	1878 032 331
8172403	1878 032 331
8172732	1878 000 635
8172801	1878 032 331
8172802	1878 000 634
8172803	1878 006 129
824991	1866 018 131
841893	1866 018 131
85000053	3400 043 032
85000104	3400 106 031
85000125	3482 123 234
85000183	3400 043 032
85000185	3400 125 601
85000235	3483 034 135
85000236	3488 019 032
85000238	1878 006 129
85000239	1878 000 634
85000240	1878 006 129
85000241	1878 000 634
85000242	1878 001 215
85000243	1878 001 215
85000244	1878 000 300

Vergleichsliste / Cross reference list

Vergleichs-Nr. Compare No.	Artikelnummer Article No.	Vergleichs-Nr. Compare No.	Artikelnummer Article No.	Vergleichs-Nr. Compare No.	Artikelnummer Article No.
VOLVO		VOLVO			
85000245	1878 000 635	85000568	3400 127 101		
85000251	3483 034 043	85000597	3400 700 423		
85000252	3488 000 024	85000624	3482 000 553		
85000263	3400 700 357	85000625	1878 006 129		
85000265	3400 700 357	85000670	1878 000 634		
85000266	3400 127 101	85000773	3400 700 360		
85000267	3400 700 343	85000775	1878 003 768		
85000268	3400 700 343	85000789	1878 634 034		
85000269	3400 700 471	85000790	1878 634 034		
85000272	1878 001 215	85000791	3400 700 466		
85000272	3483 034 034	85000794	1878 026 241		
85000273	3400 700 342	85000797	3400 700 490		
85000274	3400 700 342	85000907	3400 700 359		
85000275	1878 001 215	85001003	3488 019 032		
85000275	3483 034 033	85001033	1878 003 779		
85000276	1878 001 215	85003001	3400 700 406		
85000276	3483 034 033	85003035	1878 005 284		
85000277	3400 700 350	85003114	3400 700 358		
85000278	1878 001 215	85003116	1878 000 961		
85000278	3483 034 042	85003116	3482 602 002		
85000279	1878 006 129	85003117	3482 000 552		
85000279	3400 700 351	85003118	1878 003 867		
85000279	3483 034 043	85003119	1878 000 634		
85000283	1878 600 557	85003120	3488 000 024		
85000284	1878 000 961	85003122	1878 001 215		
85000307	3400 030 033	85003685	6482 000 155		
85000308	3400 700 407	85003903	1878 006 129		
85000309	3400 700 326	85003904	1878 006 129		
85000310	3400 700 325	85003972	3400 700 359		
85000311	1878 002 458	85003973	3400 700 359		
85000311	3488 018 031	85105941	3474 012 000		
85000312	3400 700 423	85105942	3474 012 003		
85000313	3400 700 406	855389	1866 032 231		
85000314	3400 700 427	855617	1866 118 001		
85000361	3483 034 045				
85000362	1878 040 334				
85000382	1878 000 634				
85000393	3483 034 033				
85000503	1878 006 129				
85000503	3400 700 463				
85000503	3483 000 348				
85000510	3400 700 478				
85000511	3483 000 382				
85000521	3483 034 034				
85000522	3400 700 357				
85000523	3483 034 033				
85000525	3483 034 035				
85000527	3483 034 033				
85000530	3483 034 135				
85000534	1878 006 129				
85000537	1878 006 129				
85000537	3483 000 348				
85000542	3400 700 401				
85000551	3400 043 032				
85000553	3400 043 032				
85000555	3400 127 201				
85000558	3400 700 357				
85000559	3400 127 101				
85000560	3400 700 343				
85000566	3400 700 406				
85000567	3400 700 427				

Neuaufnahmen / New to range

Artikelnummer Article No.	Seite Page	Hersteller Manufacturer
1859 600 001	31	FAUN
1859 600 001	427	MERCEDES-BENZ
1863 600 123	601 602	ÖSTERREICHISCHE AUTOMOBILFABRIK (ÖAF)
1863 869 039	697	VOLVO
1863 869 041	602	RENAULT TRUCKS
1863 869 042	247 248 249 250 251 252 253 254 255 256	MAN
1864 634 026	30	DEMAG
1866 000 239	720 721	VOLVO PENTA
1866 118 001	720 721	VOLVO PENTA
1878 001 939	394 396 397 399 401 403 404 407 410 430 431 454 455 456 457 464 465 468 469 472 477 486 493 772 793 794	MERCEDES-BENZ
1878 003 365	649 651	SCANIA
1878 005 187	352	MERCEDES-BENZ
1878 005 367	32	FAUN
1878 005 367	735	IKARUS
1878 005 367	122 125 130 131 742 743	MAGIRUS-DEUTZ
1878 005 367	200 299 300 301 303 305 308 312 763	MAN
1878 005 367	594 595 596	ÖSTERREICHISCHE AUTOMOBILFABRIK (ÖAF)
1878 005 367	642	RENAULT TRUCKS
1878 005 367	662 663	STEYR
1878 005 486	728 730 731	EVOBUS
1878 005 668	482 483 484 492 493 501 507 508 509 521 524 525 526 529 532 543 544 545 546 548 549 552 557 558 561 564 565 569 580 581 583 585 587 588 591 592 593 779 782 784 785 796	MERCEDES-BENZ
1878 005 805	732 734	EVOBUS
1878 005 805	514 515 530	MERCEDES-BENZ
1878 005 805	801 802 803 804 813 814	NEOPLAN
1878 006 101	369 370 374 379 384 385 386 387 392 393	MERCEDES-BENZ
1878 006 129	618 621 622 623 638 639	RENAULT TRUCKS

Artikelnummer Article No.	Seite Page	Hersteller Manufacturer
1878 006 129	681 682 683 686 687 698 700 701 702 703 704 705 706 711 712 718 844 845	VOLVO
1878 006 173	791	MERCEDES-BENZ
1878 006 370	653	SCANIA
1878 006 584	638	RENAULT TRUCKS
1878 006 637	458	MERCEDES-BENZ
1878 006 713	249 251 252	MAN
1878 006 854	653	SCANIA
1878 634 038	680 681	VOLVO
1878 634 052	339 340 341 342 343 344 345 346 458 462 781	MERCEDES-BENZ
1882 261 013 #	125	MAGIRUS-DEUTZ
1882 261 013 #	663	STEYR
2294 001 744	351	MERCEDES-BENZ
3000 990 287 	331 333 334 337 338 350 352 353 768 770 771	MERCEDES-BENZ
3151 000 752	635 638	RENAULT TRUCKS
3151 000 752	680 697	VOLVO
3151 000 809	680 681	VOLVO
3151 000 958	117 118	KAMAZ
3151 000 958	299 300 301 302 303 304 305 308 310 312	MAN
3151 000 958	325 326	MAZ
3151 000 958	468	MERCEDES-BENZ
3151 000 958	642	RENAULT TRUCKS
3151 001 035	623 638 639	RENAULT TRUCKS
3151 600 548	14	DAF
3400 700 395	87 88 89 90 91 92	IVECO
3400 700 396	236 249 251 252 253 256	MAN
3400 700 397	396 397 399 401 403 404 407 410 416	MERCEDES-BENZ
3400 700 398	15	DAF
3400 700 399	615 616 617 618 622 638 639	RENAULT TRUCKS
3400 700 438	623 639	RENAULT TRUCKS
3400 700 464	16 17	DAF
3400 700 465	16 17	DAF
3400 700 466	635 638	RENAULT TRUCKS
3400 700 466	680 697	VOLVO
3400 700 467	20 24 25 30	DAF
3400 700 468 	369 370 374 379 384 385 386 387 392 393	MERCEDES-BENZ
3400 700 470	618 623	RENAULT TRUCKS
3400 700 471 	698 707	VOLVO
3400 700 472 	698	VOLVO

Neuaufnahmen / New to range

Artikelnummer Article No.	Seite Page	Hersteller Manufacturer
3400 700 473	15 16 17 18 24	DAF
3400 700 474 ■	53 59 65	IVECO
3400 700 475 ■	53 59 65	IVECO
3400 700 476	15 16 18	DAF
3400 700 477 ☹	458	MERCEDES-BENZ
3400 700 478 ☺	681 698 700 701 702 703 704 705 706 712	VOLVO
3400 700 479 ☹	638	RENAULT TRUCKS
3400 700 483	42 43 44 46 47 48 50	IVECO
3400 700 484 ☹	394 396 397 399 401 403 404 407 410 431 455 456 457 464 468 477 486 772 793	MERCEDES-BENZ
3400 700 485 #	613 614 615 616 617 618	RENAULT TRUCKS
3400 700 485 #	654	SISU
3400 700 487	53 59 65	IVECO
3400 700 489	28 29	DAF
3400 700 490	680 681	VOLVO
3400 700 491	653	SCANIA
3400 700 493	736	IRISBUS
3400 700 493	823	RENAULT TRUCKS
3400 700 495 #	638	RENAULT TRUCKS
3400 700 497	736 737 738	IRISBUS
3400 700 498 ☹	732 733 734	EVOBUS
3400 710 012	396 397 416	MERCEDES-BENZ
3400 710 013	396 397 416	MERCEDES-BENZ
3400 710 014	396 397 399 401 403 404 407 410 416	MERCEDES-BENZ
3400 710 015	396 397 399 401 403 404 407 410 416	MERCEDES-BENZ
3400 710 016	394 396 397 399 401 403 404 407 410 416	MERCEDES-BENZ
3400 710 017	396 397 399 401 403 404 407 410 416	MERCEDES-BENZ
3400 710 060	615 616 638 639	RENAULT TRUCKS
3400 710 060	698 699 700 701 840 844 845	VOLVO
3400 710 061	618 623 638 639	RENAULT TRUCKS
3400 710 061	682 683 700 702 703 705 844 845	VOLVO
3421 601 069	458	MERCEDES-BENZ
3482 000 953	6 14	DAF

Artikelnummer Article No.	Seite Page	Hersteller Manufacturer
3482 000 953	475 477 478 480 481 485 487 488 489 490 505 506 511 536 543 795	MERCEDES-BENZ
3482 000 999	653 654	SCANIA
3482 634 003	635 638	RENAULT TRUCKS
3482 634 003	680 697	VOLVO
3482 634 004	618 623 639	RENAULT TRUCKS
3482 634 005	680 681	VOLVO
3483 000 461 ☺	417	MERCEDES-BENZ
6283 600 539	351 352	MERCEDES-BENZ
6284 605 004	331 333 334 337 338 768	MERCEDES-BENZ
6284 605 004	668 836	VOLKSWAGEN
6284 605 008	350 351 352 353 770 771	MERCEDES-BENZ
6482 000 155	604 612 615 616 617 618 623 638 639 644	RENAULT TRUCKS
6482 000 155	681 682 683 689 690 698 699 700 701 702 703 704 705 706 712 840 844 845	VOLVO
6482 000 171	690	VOLVO
6594 000 171	737	IRISBUS

Geänderte Bestellnummer / Amended part numbers

Artikelnummer alt Article No. old	Artikelnummer neu Article No. new	Artikelnummer alt Article No. old	Artikelnummer neu Article No. new	Artikelnummer alt Article No. old	Artikelnummer neu Article No. new
1815 000 004	1874 000 006				
1815 089 100	1874 015 200				
1859 029 000	1859 600 001				
1860 039 027	1864 634 026				
1861 303 246	1861 303 248				
1861 557 236	1878 634 052				
1861 560 234	1878 002 955				
1861 678 002	1878 001 144				
1861 911 304	1878 005 486				
1861 963 004	1861 963 033				
1862 138 035	1862 138 032				
1862 190 105	1878 005 805				
1862 193 105	1878 005 805				
1862 208 032	1878 022 841				
1862 216 032	1878 005 668				
1862 441 131	1878 080 034				
1866 118 031	1866 118 001				
1878 000 948	1878 006 129				
1878 001 938	1878 002 139				
1878 001 968	1862 248 033				
1878 002 730	1878 005 165				
1878 003 868	1878 006 129				
1878 005 311	1878 006 129				
1878 039 731	1878 000 611				
1878 080 035	1878 004 832				
1878 634 022	1878 005 805				
1878 634 023	1878 005 805				
1882 261 006	1882 261 013				
1888 015 237	1888 015 523				
2294 000 628	2294 001 744				
2294 000 833	2294 001 744				
3000 990 177	3000 990 218				
3000 990 178	3000 990 218				
3000 990 180	3000 990 218				
3151 028 043	3151 000 958				
3151 067 031	3151 000 958				
3182 008 037	3182 998 501				
3400 700 314	3400 700 380				
3400 700 363	3400 122 301				
3400 700 453	3400 117 801				
3400 700 501	3400 700 527				
3400 700 502	3400 700 519				
3459 011 101	3459 004 108				
3482 000 554	3482 000 865				
3482 000 556	3482 000 999				
3482 011 331	3482 000 953				
3482 051 131	3482 000 953				
3482 067 101	3482 067 102				
6482 000 087	6482 000 155				
6482 000 156	6482 000 171				

Geänderte Bestellnummer / Amended part numbers

Artikelnummer neu Article No. new	Artikelnummer alt Article No. old	Artikelnummer neu Article No. new	Artikelnummer alt Article No. old	Artikelnummer neu Article No. new	Artikelnummer alt Article No. old
1859 600 001	1859 029 000	1878 005 805	1878 634 022	3400 122 301	3400 700 363
1861 303 248	1861 303 246	1878 005 805	1878 634 023	3400 700 380	3400 700 314
1861 963 033	1861 963 004	1878 006 129	1878 000 948	3400 700 519	3400 700 502
1862 138 032	1862 138 035	1878 006 129	1878 003 868	3400 700 527	3400 700 501
1862 248 033	1878 001 968	1878 006 129	1878 005 311	3459 004 108	3459 011 101
1864 634 026	1860 039 027	1878 022 841	1862 208 032	3482 000 865	3482 000 554
1866 118 001	1866 118 031	1878 080 034	1862 441 131	3482 000 953	3482 011 331
1874 000 006	1815 000 004	1878 634 052	1861 557 236	3482 000 953	3482 051 131
1874 015 200	1815 089 100	1882 261 013	1882 261 006	3482 000 999	3482 000 556
1878 000 611	1878 039 731	1888 015 523	1888 015 237	3482 067 102	3482 067 101
1878 001 144	1861 678 002	2294 001 744	2294 000 628	6482 000 155	6482 000 087
1878 002 139	1878 001 938	2294 001 744	2294 000 833	6482 000 171	6482 000 156
1878 002 955	1861 560 234	3000 990 218	3000 990 177		
1878 004 832	1878 080 035	3000 990 218	3000 990 178		
1878 005 165	1878 002 730	3000 990 218	3000 990 180		
1878 005 486	1861 911 304	3151 000 958	3151 028 043		
1878 005 668	1862 216 032	3151 000 958	3151 067 031		
1878 005 805	1862 190 105	3182 998 501	3182 008 037		
1878 005 805	1862 193 105	3400 117 801	3400 700 453		

Gestrichene Nummern / Deleted references

Artikelnummer Article No.	Artikelnummer Article No.	Artikelnummer Article No.
1850 280 181	1882 206 203	3000 990 152
1850 480 055	1882 288 104	3000 990 254
1861 433 401	1882 304 205	3032 000 216
1861 561 002	1882 304 234	3072 000 013
1861 562 231	1882 600 107	3074 004 000
1861 696 044	1888 023 102	3074 600 220
1861 732 031	1888 876 003	3082 001 492
1861 743 131	1888 998 301	3082 001 498
1861 744 133	1890 801 001	3082 001 499
1861 825 002	1896 094 100	3082 001 503
1861 845 132	2290 601 029	3082 096 231
1861 981 202	2294 001 346	3082 098 131
1862 428 134	3000 030 008	3082 240 031
1862 609 001	3000 044 002	3082 600 544
1862 626 001	3000 047 008	3082 600 572
1862 682 001	3000 047 009	3082 600 594
1862 705 001	3000 047 010	3082 600 741
1862 723 001	3000 101 002	3082 634 601
1862 801 001	3000 169 002	3082 638 501
1862 819 001	3000 182 002	3082 641 102
1862 821 001	3000 189 001	3082 641 301
1862 835 002	3000 221 002	3082 641 401
1862 843 002	3000 253 001	3082 642 901
1862 864 002	3000 257 001	3082 684 001
1862 906 002	3000 272 001	3082 690 001
1862 906 004	3000 280 002	3082 780 001
1862 907 002	3000 306 001	3082 797 001
1863 600 103	3000 356 001	3082 867 005
1863 820 001	3000 427 001	3082 878 002
1863 841 001	3000 432 001	3082 883 001
1864 000 236	3000 477 001	3082 892 001
1864 066 210	3000 481 001	3082 916 001
1864 093 031	3000 481 002	3082 925 001
1864 103 018	3000 500 001	3082 957 003
1864 122 146	3000 519 001	3082 999 450
1864 338 001	3000 532 001	3089 998 901
1864 498 001	3000 544 001	3100 002 258
1864 600 319	3000 592 001	3100 026 435
1864 634 006	3000 603 001	3151 104 001
1864 922 003	3000 662 001	3151 146 001
1865 006 001	3000 663 001	3151 192 041
1866 026 131	3000 760 001	3163 041 003
1866 031 101	3000 764 001	3182 998 904
1866 050 001	3000 768 001	3400 700 419
1874 000 047	3000 825 101	3482 924 001
1878 000 824	3000 845 401	3483 018 131
1878 002 103	3000 856 601	3496 008 000
1878 003 248	3000 857 501	6284 000 142
1878 038 641	3000 950 625	6284 000 143
1878 053 831	3000 951 029	6284 008 531
1878 600 575	3000 951 154	6284 600 132
1878 600 633	3000 951 155	6284 600 133
1878 600 655	3000 951 169	6284 600 135
1878 600 660	3000 951 194	6284 600 136
1878 600 671	3000 951 441	6284 600 144
1878 600 919	3000 951 442	6284 600 615
1878 600 931	3000 951 499	6284 600 654
1878 600 934	3000 951 601	
1878 634 015	3000 951 733	
1878 987 801	3000 951 953	
1878 989 301	3000 954 099	
1878 992 701	3000 960 701	
1878 998 801	3000 960 801	
1881 050 424	3000 990 041	
1881 050 429	3000 990 092	
1881 051 313	3000 990 102	
1882 021 101	3000 990 124	

**© ZF Friedrichshafen AG,
ZF Services - 22.05.14**

Maßtabelle für Nabenprofile

Measure table for hub profiles

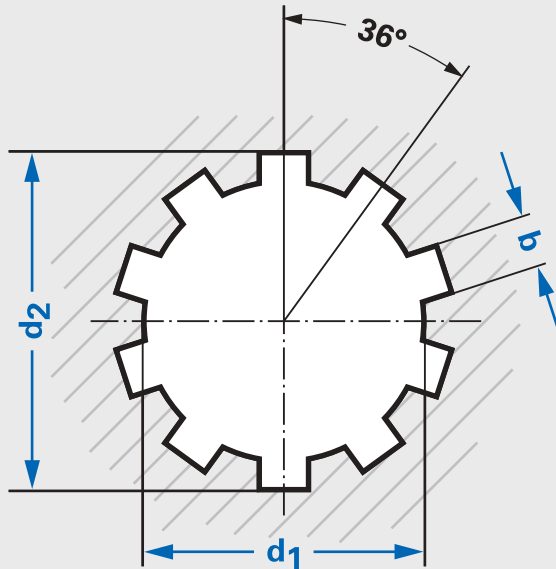

Profiles in inches	$\varnothing d_1$ [mm]	$\varnothing d_2$ [mm]	b [mm]
5/8 "	13,70	16,10	2,50
7/8 "	19,10	22,20	3,45
1 "	20,60	25,80	3,93
1 1/8 "	23,40	28,90	4,45
1 1/4 "	25,80	32,10	4,93
1 3/8 "	28,70	35,20	5,43
1 1/2 "	30,70	38,40	5,89
1 5/8 "	33,40	41,30	6,40
1 3/4 "	36,00	44,50	6,88
2 SAE "	41,10	50,80	7,88

Maßtabelle für Schwungscheiben

Measure table for flywheels

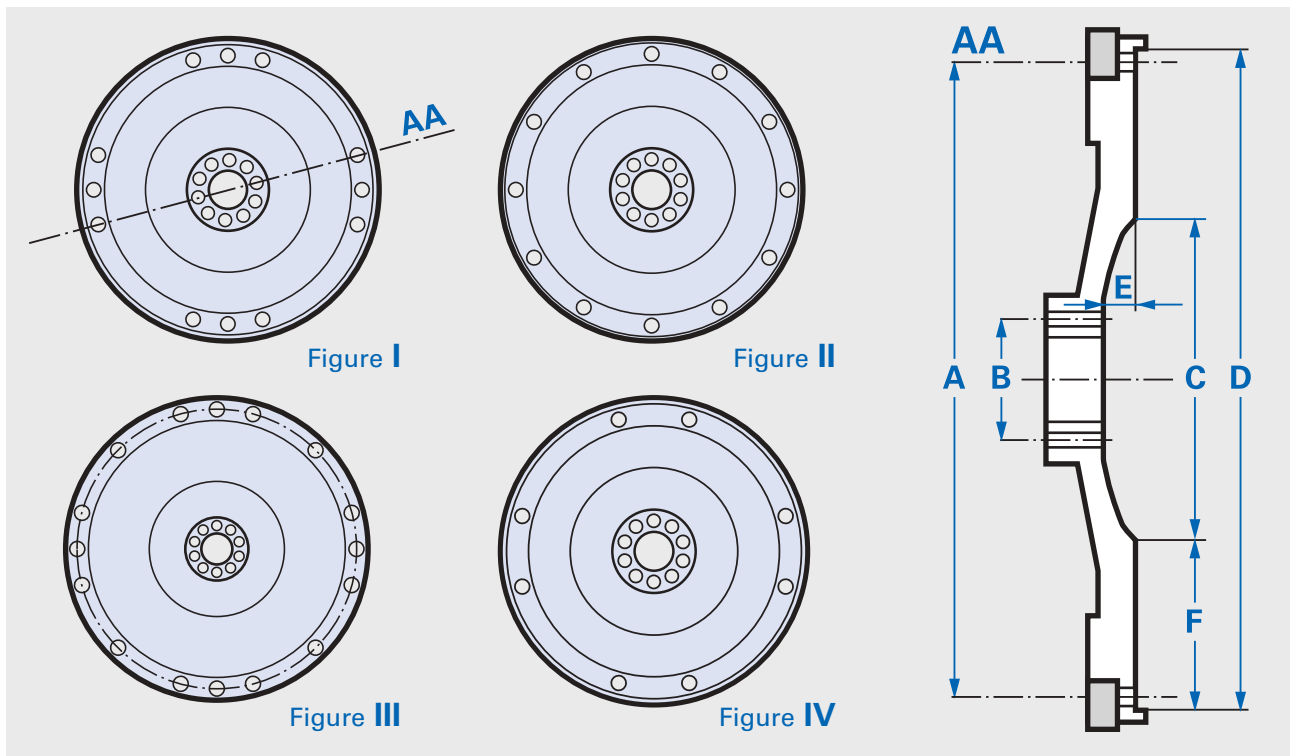

SACHS	Figure	A [mm]	B [mm]	C [mm]	D [mm]	E [mm]	F [mm]
3421 601 001	II	410,00	125,00	193,00	435,00	19,00	121,00
3421 601 002	I	375,00	105,00	190,00	395,00	13,50	102,50
3421 601 003	IV	345,00	105,00	162,00	365,00	23,00	101,50
3421 601 004	IV	345,00	105,00	162,00	365,00	29,00	101,50
3421 601 007	II	410,00	105,00	192,00	435,00	13,50	121,50
3421 601 009	II	410,00	88,00	196,00	435,00	17,50	119,50
3421 601 010	II	450,00	88,00	216,00	475,00	17,50	129,50
3421 601 011	I	450,00	88,00	235,00	475,00	19,00	120,00
3421 601 012	I	450,00	88,00	235,00	475,00	19,00	120,00
3421 601 014	III	450,00	88,00	235,00	475,00	19,00	120,00
3421 601 015	III	450,00	88,00	235,00	475,00	19,00	120,00
3421 601 016	I	450,00	88,00	235,00	475,00	17,50	120,00
3421 601 017	II	410,00	88,00	245,00	435,00	17,50	95,00
3421 601 019	II	450,00	112,00	235,00	470,00	29,50	117,50
3421 601 020	II	450,00	105,00	235,00	470,00	30,50	117,50
3421 601 021	II	450,00	88,00	235,00	475,00	17,50	120,00
3421 601 024	II	450,00	105,00	215,00	470,00	29,50	127,50
3421 601 025	II	450,00	88,00	235,00	475,00	21,00	120,00
3421 601 037	I	450,00	125,00	238,50	470,00	23,00	115,75
3421 601 038	I	450,00	110,00	237,00	475,00	26,00	119,00
3421 601 041	II	450,00	130,00	236,00	475,00	35,00	119,50
3421 601 042	II	450,00	112,00	235,00	470,00	29,50	117,50
3421 601 043	III	450,00	88,00	257,00	475,00	21,00	109,00
3421 601 044	III	450,00	88,00	257,00	475,00	21,00	109,00
3421 601 045	III	450,00	88,00	257,00	475,00	22,20	109,00
3421 601 046	III	450,00	88,00	257,00	475,00	22,50	109,00

Maßtabelle für Schwungscheiben

Measure table for flywheels

 SACHS	Figure	A [mm]	B [mm]	C [mm]	D [mm]	E [mm]	F [mm]
3421 601 047	III	450,00	88,00	235,00	475,00	21,00	120,00
3421 601 048	II	410,00	74,00	235,50	435,00	19,30	99,75
3421 601 049	II	410,00	84,00	235,50	435,00	19,30	99,75
3421 601 050	I	450,00	88,00	235,00	475,00	17,50	120,00
3421 601 051	II	375,00	74,00	236,00	395,00	19,50	79,50
3421 601 052	II	375,00	84,00	235,50	395,00	20,00	79,75
3421 601 053	I	450,00	84,00	235,50	475,00	18,50	119,75
3421 601 054	II	450,00	88,00	257,00	470,00	29,30	106,50
3421 601 055	II	450,00	112,00	257,00	470,00	29,50	106,50
3421 601 056	II	375,00	74,00	235,50	395,00	26,00	79,75
3421 601 057	II	450,00	105,00	236,00	470,00	30,50	117,00
3421 601 058	II	450,00	112,00	257,00	470,00	29,50	106,50
3421 601 059	II	450,00	112,00	257,00	470,00	29,50	106,50
3421 601 060	I	450,00	153,00	237,50	475,00	42,00	118,75
3421 601 061	I	450,00	140,00	235,50	475,00	35,00	119,75
3421 601 062	III	450,00	88,00	257,00	475,00	22,50	109,00
3421 601 063	III	450,00	88,00	235,00	475,00	22,20	120,00
3421 601 064	II	410,00	85,00	193,20	435,00	19,50	120,90
3421 601 065	II	410,00	85,00	193,00	435,00	19,00	121,00
3421 601 066	I	450,00	140,00	235,70	475,00	35,00	119,65
3421 601 067	I	450,00	100,00	237,00	475,00	31,10	119,00
3421 601 068	II	375,00	84,00	235,60	395,00	19,70	79,70
3421 601 071	I	450,00	110,00	256,00	475,00	22,30	109,50
3421 601 072	I	450,00	110,00	256,00	475,00	22,30	109,50
3421 601 073	I	450,00	110,00	256,00	475,00	22,20	109,50
3421 601 074	I	450,00	110,00	256,00	475,00	22,20	109,50
3421 601 075	III	450,00	88,00	235,50	475,00	22,30	119,75

- DE** *Kupplungen für Nfz*
- EN** *Clutches for CV*
- FR** *Embrayages pour VU*
- ES** *Embragues para vehículos industriales*
- PT** *Embreagens para veículos utilitários*
- IT** *Frizioni per veicoli commerciali*
- NL** *Koppelingen voor bedrijfswagens*
- NO** *Clutcher for nyttekjøretøy*
- SV** *Kopplingar för nyttofordon*
- FI** *Kytkimet hyötyajoneuvoon*
- PL** *Sprzęgła dla pojazdów użytkowych*
- RU** *Сцепления для грузовых а/м*
- HU** *Tengelykapcsolók haszonjárművekhez*
- CS** *Spojky pro užitková vozidla*
- RO** *Ambreiaje pentru autoutilitare*
- HR** *Spojke za gospodarska vozila*
- EL** *Συμπλέκτες για οχήματα ΔΧ*
- TR** *Ticari araçlar için debriyajlar*
- ZH** *商用车离合器*

