

WABCO

Automotive South Africa

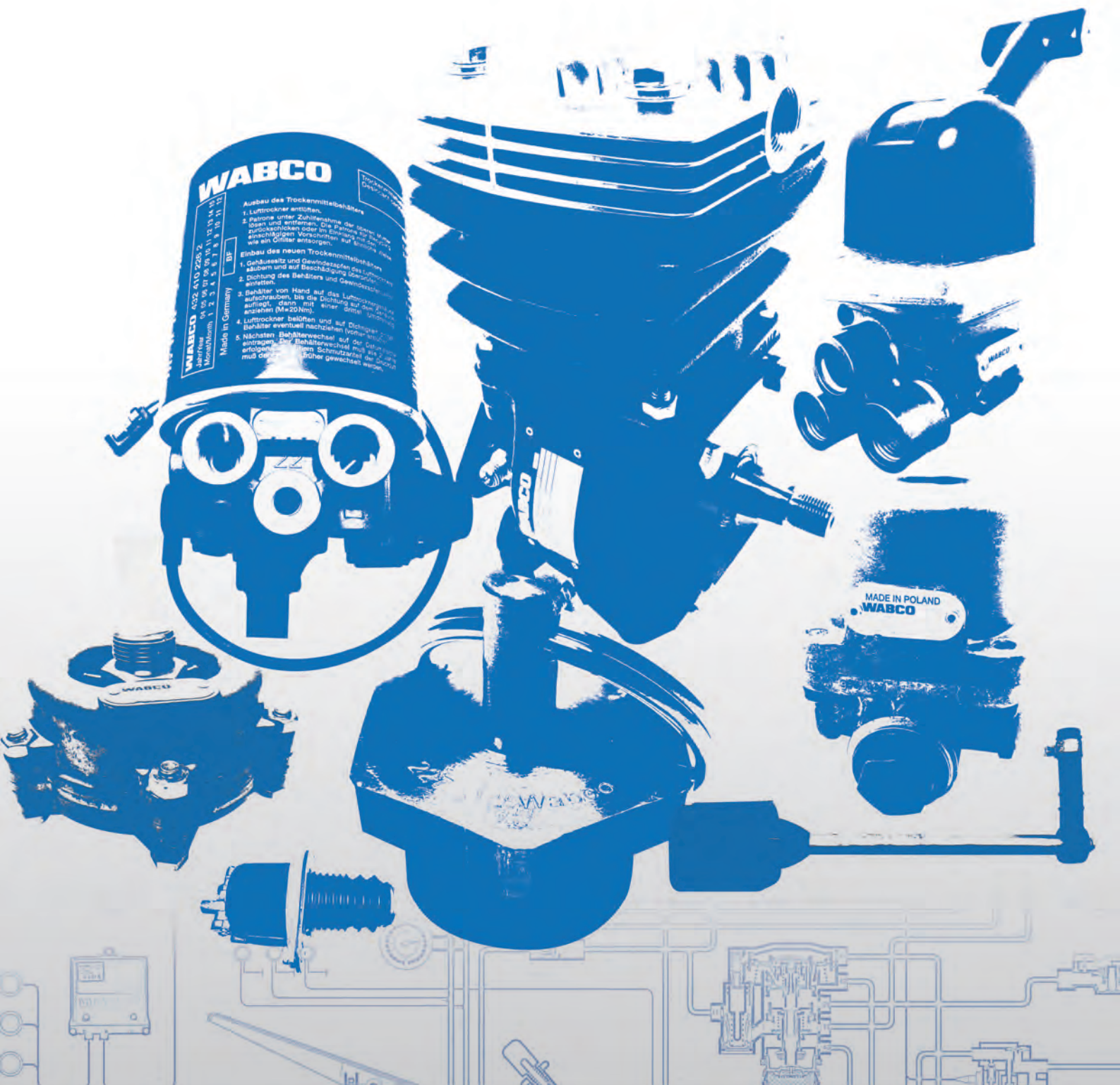

Quick Catalogue 2014

WABCO

Automotive South Africa

QUICK CATALOGUE 2014

ABS Components-Truck/Bus	34	Line Filter	23
ABS/EBS - Speed Sensors	38	Load Regulating Valve	12
Adaptor Valves	13	Load Sensing / Levelling Valve Parts	32
Air Dryers	9	Load Sensing Valves -Air Susp	19
Air Processing Units	10	Load Sensing Valves -Mech Susp	18
Air Reservoirs	13	Low Pressure Switches	12
Air Throttle Valves	29	Non-Return Valves	25
Brake Chambers	29	Nylon Pipes	33
Brake Chambers -Disc Brakes	30	Operating Cylinders	27
Cartridges - Desiccant	9	Pressure Limiting Valves	12
Charging Valves	11	Proportional Valves	27
Clutch Servos	24	Quick Release Valves	20
Compressors	5	Raise / Lower Valve	23
Condensor Drain Valves	13	Relay Emergency Valves	21
Couplings (Duomatic)	28	Relay Valves	22
Couplings (F & J)	29	Rubber Hose	33
Couplings (Palm)	28	Safety Valves	25
Cylinder Heads	8	Servo - Air / Hydraulic	26
Diagnostic Software	40	Shut-Off Cock	21
Diaphragms	32	Silencers	28
Door Control Valve	28	Solenoid Valves	27
Double Check Valves	25	Spiral Binding	33
Double Diaphragm Spring Brakes	31	Spring Boxes	19
Double Diaphragm Spares	31	Spring Brakes	30
Drain Valves	13	Spring Brakes Wedge	30
EBS Components - Trailers	36	Spring Brakes -Disc Brakes	30
EBS Components - Truck	34	Spring Brake Spares	31
EBS Software	40	Stop Light Switches	12
ECAS Truck Components	35	Suzy Pipes	33
Electrical Suzy	33	Test Equipment ABS	40
Empty Load Valves	13	Test Equipment Pneumatic	41
Exhaust Brake Valves	25	Throttled Check choke Valve	25
Foot Brake Valves	14	Trailer Control Valves	20
Four Circuit Protection Valves	11	Trailer Release Valve (PREV)	21
Gearbox / Control / 3/2-way	26	Unloader Valves	9
Governor Valves	9		
Hand Control Valves	15	FITTINGS CATALOGUE	
Levelling Valves	23	Compression Fittings	43
Lift Axle Control Valves	38	Push In Fittings	49

TRUCK COMPONENTS

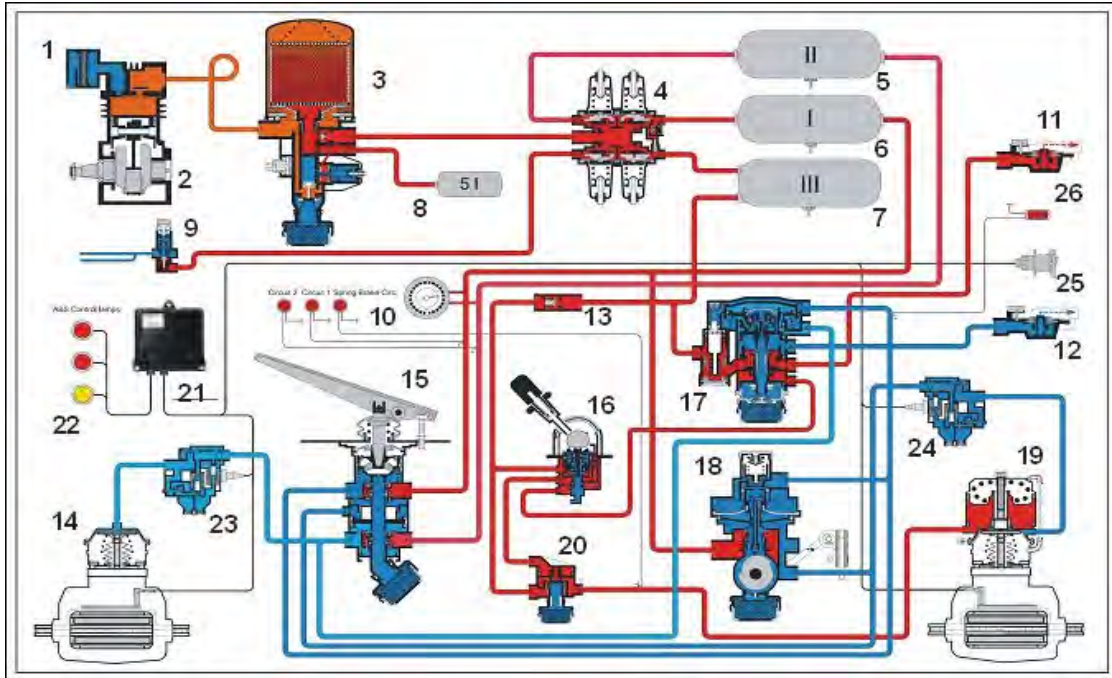

- | | |
|---|---------------------------------|
| 1 Suction Strainer | 14 Brake Chamber |
| 2 Compressor | 15 Foot Brake Valve |
| 3 Air Dryer | 16 Park Brake Valve |
| 4 Four Circuit Protection Valve | 17 Trailer Control Valve |
| 5 Reservoir Circuit 2 (Front Brakes) | 18 Relay Load Sensing Valve |
| 6 Reservoir Circuit 1 (Rear Brakes) | 19 Spring Brakes |
| 7 Reservoir Circuit 3 (Park Brakes / Trailer) | 20 Relay Valve |
| 8 Reservoir (Regeneration) | 21 ABS ECU |
| 9 Exhaust Brake Valve | 22 ABS Warning Lamps |
| 10 Pressure Gauges | 23 ABS Solenoid Valve (Front) |
| 11 Coupling (Red) Emergency Line | 24 ABS Solenoid Valve (Relay) |
| 12 Coupling (Yellow) Service Line | 25 Power Supply Cable (Trailer) |
| 13 Non Return Valve | 26 Stop Light |

TRAILER COMPONENTS

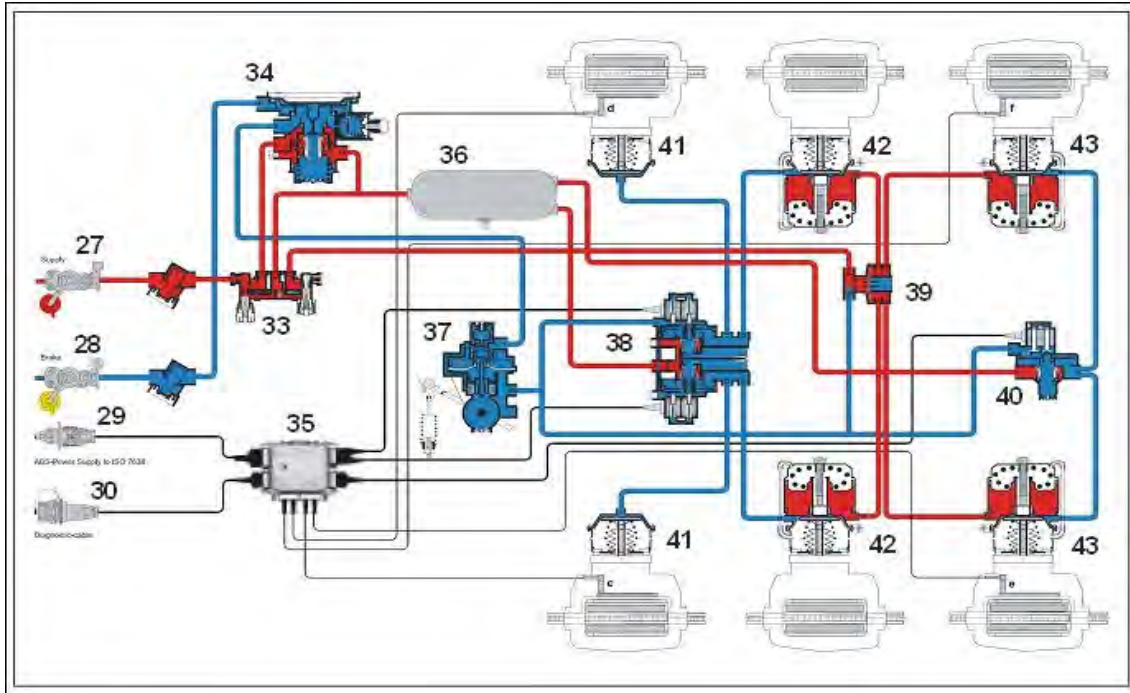

- | | |
|-----------------------------------|---|
| 27 Coupling (Red) Emergency Line | 40 ABS Solenoid Relay Valve (Steering Axle) |
| 28 Coupling (Yellow) Service Line | 41 Brake Chamber |
| 29 ABS Power Supply Cable | 42 Spring Brake |
| 30 ABS Diagnostic Cable | 43 Spring Brake |
| 31 Line Filter | |
| 32 Line Filter | |
| 33 Park Shunt Valve | |
| 34 Relay Emergency Valve | |
| 35 ABS ECU | |
| 36 Air Reservoir | |
| 37 Relay Load Sensing Valve | |
| 38 ABS Modulator Relay Valve | |
| 39 Quick Release Valve | |

COMPRESSORS

411 003 000 0 **Single Cylinder Compressor**
411 003 001 0 150cm³ - Self Lube (75mm Bore)
411 003 011 0 411 003 000 0 Superceded to 411 003 011 0

ASA5272 Gasket kit including oil seal
 ASA5273 Ring Set (75mm Bore)
 411 003 340 4 Con Rod Bearing
 411 141 623 2 Piston Complete
 ASA6282 Head Kit for 411 003 011 0 only
 411 003 733 2 Con rod Complete
 A97/147 Pulley 8" Diam
 432 600 000 0 Filter - Wet Suction

411 034 501 0 **229cm³. UD (Rotation Forced Oiling.)**
MERCEDES 355
 AC (Air Cooling). 2800 RPM max.
 Vickers. Flange. (90mm Bore)

ASA5280 Head Kit
 ASA5281 Gasket kit including oil seal
 ASA5410 Ring Set 90mm
 ASA6501 Complete Repair Kit
 411 042 340 4 Main Bearing Bush
 411 042 341 4 Con rod Bearing per half
 411 042 620 2 Piston Complete with rings



411 041 845 0

ASA5277 Head Kit
 ASA5278 Gasket kit including oil seal
 ASA5273 Ring Set 75mm
 411 042 340 4 Main Bearing Bush
 411 042 341 4 Con rod Bearing per half

411 141 000 0 **Single Cylinder (75mm Bore) Mono block**
DEUTZ / IVECO / BELL COMPRESSOR

411 042 341 4 Con Rod Bearing per half
 411 141 205 4 Main Bush
 ASA5273 Ring Set 75mm
 ASA6312 Head Kit
 ASA6313 Gasket Kit
 A97/147 Pulley 8" Diam
 411 141 623 2 Piston and Rings



411 143 805 0 **293cm³. UD. AC. 3000 RPM max (90mm Bore)**
DEUTZ / IVECO COMPRESSOR

ASA 5371 Head Kit ADE 407
 897 316 999 4 Gasket (not in kit above)
 897 670 190 4 "O" Ring Front
 811 408 040 4 Oil Seal
 ASA 5410 Ring Set 90mm
 411 141 205 4 Bush



411 142 711 0 **229cm³ Single Cylinder UD. 3000 RPM max (90mm Bore)**
MERC 1924

411 142 623 2 Piston and Rings
 411 142 651 4 Cylinder Head
 ASA 5410 Ring Set 90mm
 411 142 002 2 Gasket Kit only

COMPRESSORS Continued.....

**411 145 507 0 Water Cooled, UD, 203cm³ (75mm Bore)
3000 PRM Vickers Flange.
MAN**

411 041 050 4 Valve Plate (not in kit)
411 041 051 4 Leaf Valve (not in kit)
411 042 341 4 Con Rod Bearing per half
411 141 623 2 Piston Complete with rings 75mm
411 145 000 2 Gasket Kit
411 145 653 2 Cylinder head only (NO GASKET with head)
ASA5273 Ring Set 75mm



**412 352 003 0 352cm³ UD, 3000 PRM (85mm Bore)
Watercooled
MAN**

412 352 001 2 Gasket Kit
911 004 202 4 Main Bearing Bush
911 501 624 2 Piston With Rings 85mm
911 145 738 2 Con Rod
412 352 924 2 Cylinder Head L shape
895 073 589 4 Sump (welsh) Plug
ASA6690 Ring set Per Piston 85mm



**411 151 003 0 Single Flange Compressor (85mm Bore)
Flange, Water Cooled 411 151 008 0 supercedes
MERCEDES
Supercedes 411 151 009 0**

411 154 002 2 Cylinder Head (Includes gasket) old no 411 154 800 2
911 501 624 2 Piston and Rings
411 154 000 2 Gasket Kit
411 151 052 4 Gasket Barrel to Valve Pl:
ASA6690 Ring set Per Piston 85mm



**412 154 004 0 352cm³. UD. WC. 3000 RPM max.
Flange Compressor (85mm Bore)
ACTROS / ATEGO / BELL
Supercedes: 411 154 000 0 and 411 154 003 0
Mercedes Number: A9061304915**



411 154 800 2 Cylinder Head & Gasket
911 501 624 2 Piston and Rings
911 145 738 2 Con Rod
411 154 000 2 Gasket Kit
411 151 052 4 Gasket Barrel to Valve Plate (Incl in gasket kit above)
ASA6690 Ring set Per Piston 85mm



**412 352 027 0 Single Cyl Water Cooled (85mm bore)
352cm³. UD. WC. 3000 RPM max.
Replaces 412 352 016 0 & 412 352 014 0
AXOR**

911 501 624 2 Piston and Rings
ASA6690 Ring set Per Piston 85mm
412 352 923 2 Gasket Kit
412 352 922 2 Cylinder Head

A457 131 01 80 MUST USE Flange Seal **
**** only from Merc dealers *****





COMPRESSORS Continued.....

412 704 008 0	Twin Cylinder with PR (Power Reduction) Valve	
412 704 001 0	704cm³. WC. (85mm bore)	
412 704 004 0	VOLVO FH12 (20701801)	
412 704 005 0		
412 704 932 2	Cylinder Head c/w metal gasket	
412 704 920 2	Gasket kit	
911 501 624 2	Piston with rings x2	
911 505 732 2	Conrod	
ASA6690	Ring set Per Piston 85mm	

412 704 014 0	Twin Cylinder with PR (Power Reduction) Valve	
	S/S 412 704 006 0	
	VOLVO FM9	
412 704 933 2	Head & Gasket	
911 501 624 2	Piston and Rings	
ASA6690	Ring set Per Piston 85mm	

412 704 015 0	Twin Cylinder with PR (Power Reduction) Valve	
	704cm³. WC. (85mm bore) 3 Hole Mounting Off Centre	
	VOLVO (20845313)	
412 704 933 2	Head & Gasket for 412 704 015 0	
ASA6690	Ring set Per Piston 85mm	
911 501 624 2	Piston and Rings	

412 704 018 0	Twin Cylinder with PR (Power Reduction) Valve	
	S/S 412 704 015 0	
	704cm³. WC. (85mm bore) 3 Hole Mounting Off Centre	
	VOLVO (21172036)	
412 704 940 2	Head & Gasket for 412 704 018 0	
ASA6690	Ring set Per Piston 85mm	
911 501 624 2	Piston and Rings	

911 142 000 0	229cm³ Single Cylinder (90mm bore)	
411 142 623 2	Piston and Rings	

911 504 506 0	Twin Cylinder WC.	
	443cm³. UD. WC. (75mm bore) 3000 RPM max.	
	DAF 95X COMPRESSOR Replaces 911 504 504 0 (1736785)	
911 504 920 2	Cylinder Head	
411 141 623 2	Piston with Rings x2	
A6608	Ring Set x2 75mm	
911 504 923 2	Gasket Kit	

911 506 505 0	440cm³, UD. WC. 3000RPM. Flange (75mm Bore)	
	Steering Pump	
	IVECO Bus	
911 506 928 2	Gasket Kit	
411 141 623 2	Piston with Rings	
911 506 924 2	Kit (Bottom) Welsh plug and front bearing	
A6608	Ring Set x2 75mm	
ASA7073	Repair kit complete	

COMPRESSORS Continued.....

911 506 054 0 **Twin Cylinder 440cm³ (75mm Bore)
Flange Compressor
IVECO**

- 911 506 691 4 Crankshaft
- 911 145 734 2 Con Rod
- 411 141 623 2 Piston
- 911 506 925 2 Cylinder Head
- A6608 Ring Set x 2 75mm



M100960 **Single Cylinder 160cm³
Air Cooled (65mm Bore)
TATA**

- M111410 Valve Plate
- MSP1/226 Ring Set
- MSP1/216 Gasket Kit

412 100 805 2 S/S **Water Cooled Head**
412 100 806 2 **MAN F2000**

Note: Excluding Cylinder Head Gasket



412 090 803 2 **MAN TGA - COMPRESSOR HEAD ONLY**
412 090 801 2 **NO GASKET with Head**

For TGA buy 2 heads
(51 541146081)

411 033 801 2 **ADE 400 COMPLETE HEAD (THIN PLATE) - M/BENZ**
ASA5371 Head kit

912 551 001 0 **476cm³. UD. WC. (85mm bore) 3000 RPM max.**
912 551 002 0 **UD (NISSAN DIESEL) -Compressor exclusive to UD
COMPRESSOR HEAD ONLY**

- 912 551 921 2 Cylinder Head
- ASA6690 Ringset Per Piston 85mm

912 510 103 0 **Twin Cylinder WC.**
636cm³. UD. WC. (85mm bore) 3000 RPM max.
AXOR

912 510 104 0 **Use 912 510 103 0 Move plug as required**
912 510 920 2 Cylinder Head

A457 131 01 80 **MUST USE Flange Seal ******
****** only from Merc dealers *****



VARIOUS

411 553 003 0 **ATEGO BUS S/S 411 553 001 0**
411 553 921 2 repair kit

911 505 150 0 **TWIN COMPRESSOR VOLVO FL7**
911 505 001 2 repair kit

911 506 505 0 **TWIN 75MM BORE (IVECO)**
911 153 525 0 CUMMINS Only
911 154 510 0 CUMMINS Only
911 154 920 2 Head for 911 154 500 0

911 155 521 0 SINGLE CYLINDER VW

Universal Cylinder Head

412 704 940 2 Head & Gasket for the following Compressors

- 412 704 018 0 VOLVO
- 912 512 008 0 VOLVO
- 912 514 003/4 0 Renault
- 912 551 002 0 Nissan

UNLOADER AND GOVERNOR VALVES



975 303 473 0 / 474 0



275508

Part Number	Cut Out Pressure	Repair Kit	Service Kit	Description	Port size
975 303 473 0	8.1 Bar 2 Port	975 303 001 2	ASA 5698	General Truck / Bus	M22 x 1.5
975 303 474 0	8.1 Bar 4 Port	975 303 001 2	ASA 5698	General Truck / Bus	M22 x 1.5
275508	7.6 Bar (cut in 5.8bar)	26723	ASA 5699	ERF, Scania, International	1/8"

GENERAL AIR DRYERS



432 410 083 0



432 410 113 / 117 0 / 202 0



432 420 002 0 / 008 0



932 400 024 0

Part Number	Repair kits			Cut Out Pressure	Description / Application
	Unloader	Dryer	Cartridge		
432 410 000 0	432 410 001 2	432 410 002 2	432 410 222 7	8.1 Bar	With 24V Heater same as ...200 0
432 410 200 0	432 410 001 2	432 410 002 2	432 410 222 7	8.1 Bar	With 24V Heater cut out pressure tag
432 410 022 0	432 410 001 2	432 410 002 2	432 410 222 7	9.5 Bar	With 24V Heater Port 4 M12 Snap on Exhaust. Nissan
432 410 083 0/095 0	432 410 001 2	432 410 002 2	432 410 927 2	9.3 Bar	With 24V heater & port 4/23 PR valve line Scania
432 410 101 0					Superseded to 432 410 202 0
432 410 111 0					Superseded to 432 410 113 0 port22 M16 not M12
432 410 113 0	432 410 001 2	432 410 002 2	432 410 222 7	12.5 Bar	No Heater. Snap on Exhaust. Voss. MAN
432 410 117 0	432 410 001 2	432 410 002 2	432 410 222 7	10 Bar	No Heater. Snap on Exhaust. Voss. MAN F2000
432 410 202 0	432 410 001 2	432 410 002 2	432 410 222 7	8.1 bar	Snap on Exhaust. Voss. General Use Piston A6645
432 410 120 0				12.5 Bar	Superseded to 432 410 720 0
432 410 720 0	432 410 001 2	432 410 002 2	432 410 222 7	12.5 Bar	with Unloader, MAN, TGA,TGL,TGS,TGM
432 415 029 0	No Repair Kit		432 410 222 7	8.3 Bar	With Heater. ERF.
432 415 055 0		432 415 921 2		10 Bar	Hino Similar to Rockwell Air dryer
432 415 138 0		432 410 002 2		10 Bar	Renault Similar to Rockwell Air dryer
432 420 002 0	432 410 001 2	432 410 002 2	432 410 222 7	13 Bar	No Heater Pt 4 M12 Ports M22 Merc Volvo
432 421 008 0		432 410 002 2	432 410 222 7	13 Bar	No Heater Unloader Pt 4 M16&M22 Snap on Exh. Voss
432 431 008 0		432 431 002 2	432 410 222 7		With Heater. Pt M22 Twin Cannister. Volvo.
432 432 279 0	432 410 001 2	432 432 000 2	432 410 222 7	10 Bar	With Heater. Twin Cannister. Volvo.
932 400 001 0	432 410 001 2	932 400 000 2	432 420 220 2	12 Bar	No Heater. for APU 932 500 001 0/006 0 No port 4
932 400 002 0	432 410 001 2	932 400 000 2	432 420 220 2	12 Bar	With Heater. for APU 932 500 005 0 No port 4
932 400 005 0	432 410 001 2	932 400 000 2	432 420 220 2	12 Bar	No Heater.for APU 932 500 013 0 with port 4 Actros
932 400 024 0 Note	432 410 001 2	932 400 000 2	432 420 220 2	12 Bar	Replaces 010/ 020/ 050 Kit ASA7015 with mods Actros
432 425 105 0 Note		432 410 002 2	432 901 223 2	13 Bar	Replaces 432 425 001 0/ 101 0 ECAD Volvo FH FM
932 510 004/5 0 /6 0		932 510 956 2			SCANIA 932 510 958 2 Quad Valve (No PC Board)
432 410 552 2					Exhaust

NOTE AIR DRYERS: ASA7070 Repairs 432 410 ... to 432 421 Dryer and Unloader section & include Vers A & B spares
Version B Piston 432 410 622 4 Version A Piston A6645

ASA7015 Repairs 932 400 001 0/ 002 0 / 005 0/ 024 0

Note: **432 425 920 2** Solenoid Kit
A6645 Piston (Brass)

AMERICAN VEHICLE AIR DRYERS

432 413 003 0 **0.7 Backflow. 12v With heater**
INTERNATIONAL Rockwell Airdryer
 Port 4 = 1/4" NPT.
 Cut-out Pressure 7.9bar

- 432 413 925 2 Check Valve
- 432 420 926 2 Bypass Valve
- 432 413 934 2 Turbo Cut-off Old No 432 413 928 2
- 432 413 929 2 Purge Valve
- ASA6953 Service Kit
- 432 410 222 7 Cartridge



AIR PROCESSING UNITS

932 500 006 0 **Combination Air dryer and Four Circuit**
MERCEDES ACTROS

- 932 400 001 0 Air Dryer
- 934 705 005 0 Quad valve

432 415 055 0 **Combination Air dryer and Four Circuit**
UD Trucks

932 500 007 0 **Combination Air dryer and Four Circuit**
MERCEDES ACTROS

- 932 400 002 0 Air Dryer S/S 932 400 024 0
- 934 705 005 0 Quad Valve

- Repair Kit :**
- 432 410 001 2 Unloader kit
 - 932 400 000 2 Dryer kit
 - 432 420 220 2 Cartridge



934 705 005 0



932 500 006 0

AIR DRYER INSTALLATION KIT

7186210

4324102020	AIR DRYER SINGLE UNLOADER
8114010324	WASHER 12MM ALUMINIUM
8114010804	WASHER 22MM ALUMINIUM
8282519086	NYLON PIPE 6 X 1MM BLACK
8930100204	PLUG M22 X 1.5
8930402104	NYLON INSERT 6 X 1
8935111104	PIPE CLAMP 6MM
8938000140	UNION M12 X 1.5 X 6MM
8938000220	UNION M22 X 1.5 X 6MM
AGA179	AIR RESERVOIR 5L X 8"



AIR DRYER CARTRIDGES



432 410 226 2



432 420 220 2



432 410 222 7



432 901 223 2



432 410 244 2

Part Number	Port Thread	Description	Application
432 410 226 2	G 1 1/4" .	Max 13 Bar	Scania Superceded by 432 410 927 2
432 420 220 2	M39 x 1.5 .	Max 20 Bar. Without 'O' Ring	Mercedes Actros
432 410 222 7	M39 x 1.5 .	Operating 13 Bar With 'O' Ring	General. Use in place of 432 410 020 2
432 901 223 2	M39 x 1.5 .	Air System Protector 13 Bar + 'O' Ring	Extracts oil carry over
432 410 244 2	M39 x 1.5 .	Air System Protector Plus 13 Bar	Improved ASP for heavy contaminant and oil

MULTI CIRCUIT PROTECTION VALVES



934 702 210 /221/250 0



934 702 100 0/ 300 0/ 350 0
....040 0



934 714



434 700 003 0



934 705 005 0

Part Number	Opening pressure Bar				Description	Application	Repair kit
	21	22	23	24			
934 702 040 0	6.0	6.0	5.5	5.5	10 Bar 5 Port Supp-M22 Del-M16	4 Circuit	934 702 000 2
934 702 210 0	7.0	7.0	7.0	7.0	10 Bar 7 Port Supp-M22 Del-M16	General Truck/Bus	ASA 5735
934 702 221 0	7.0	7.0	7.0	7.0	20 Bar 7 Port Supp-M22 Del-M16	General Truck/Bus	ASA 5736
934 702 250 0	7.0	7.0	7.0	7.0	20 Bar 5 Port Supp-M22 Del-M16	General Truck/Bus	ASA 5394
934 702 100 0	7.0	7.0	6.0	6.0	10 Bar 5 Port Supp-M22 Del-M16	Merc, Iveco, DAF, Renault	ASA 5393
934 702 260 0	7.0	7.0	7.0	7.0	20 Bar 5 Port All ports M22	DAF, Powerliner	934 702 004 2
934 702 300 0	7.0	7.0	7.0	7.0	20 Bar 5 Port Supp-M22 Del-M16	General Truck/Bus	ASA 5391
934 702 320 0	7.0	7.0	7.0	7.0	20 Bar 5 Port Supp-M22 Del-M16	Truck/Bus Alt322 0	ASA 5735
934 705 005 0	9.0	9.0	7.5	7.5	13 Bar 23/24 limited 8.5Bar ports M22	Merc Actros 6 port	934 705 001 2
934 714 010 0	6.9	6.9	7.0	6.9	13 Bar 5 Port Port1-M22 Del-M16	MAN	
934 714 003 0	6.9	6.9	6.9	6.9	13 Bar 5 Port 3/8" NPTF/1/2"NPTF	Leyland, Ford, International	
934 714 110 0	6.9	6.9	7.0	6.9	13 Bar 5 Port Port1-M22 Del-M16		
934 714 211 0	6.5	6.5	7.4	6.5	13 Bar 5 Port Port1-M22 Del-M16	Replaces 934 714 128 0	
934 714 137 0	6.2	6.2	6.2	6.2	13 Bar 5 Port 934 705 001 2		
934 714 400 0	6.9	6.9	6.9	6.9	13 Bar 5 Port M22 VOSS	MAN TGA	
934 714 128 0	6.5	6.5	7.4	6.5	13 Bar 5 Port Port1-M22 Del-M16	SCANIA Repl 934 714 2110	
934 714 140 0	6.3	6.3	5.8	5.8	13 Bar 7 Port Port1-M22 Del-M16		
934 714 740 0	6.3	6.3	5.8	5.8	13 Bar 7 Port Port1-M22 Del-M16		
934 714 145 0	6.5	6.5	7.2	6.5	13 Bar 7 Port Port1-M22 Del-M16	Volvo	
934 714 151 0	6.5	6.5	7.5	6.5	13 Bar 5 Port Port1-BracketDel-M16	FAW Direct mounting	
434 700 003 0	5.2	5.2	N/A	N/A	10 bar 2 Port All ports M22	Mercedes Benz	434 700 003 2
932 500 501 1					Pressure Sensor for 934 705 005 0		
897 181 531 4					Diaphragm only available in kit 935 705 001 2		

CHARGING VALVES (Single Circuit Protection Valves, Overflow Valves)



Part Number	Opening pressure	Port size	Repair kit	Description
434 100 023 0	5.5 Bar	M22 x 1.5	ASA5699	With return flow
434 100 024 0	6.0 Bar	M22 x 1.5	ASA5699	With return flow
434 100 034 0	6.8 Bar	M22 x 1.5	ASA5699	With return flow
434 100 122 0	4.5 Bar	M22 x 1.5	ASA5699	No return flow
434 100 123 0	5.0 Bar	M22 x 1.5	ASA5699	No return flow
434 100 124 0	5.5 Bar	M22 x 1.5	ASA5699	No return flow
434 100 220 0	4.5 Bar	M22 x 1.5		With Limited return flow
434 100 222 0	6.2 Bar	M22 x 1.5		With Limited return flow
434 100 224 0	1.7 Bar	M22 x 1.5		With Limited return flow
434 100 227 0	5.5 Bar	M22 x 1.5		With Limited return flow
434 100 228 0	6.4 Bar	M22 x 1.5		With Limited return flow
897 131 741 4				Diaphragm for 434 100

PRESSURE LIMITING VALVES (Regulators)



475 009 026 0



475 010 010 0 / 017 0



475 010 300 0 / 301 0



475 010 400 0



475 015 001 0 / 004 0

Part Number	Limiting Pressure	Port size	Repair kit	Description / Application
475 009 008 0	0.7 Bar	M12 x 1.5		MAN
475 009 026 0	3.0 Bar	M12 x 1.5		Merc MAN Scania
475 010 010 0	4.0 Bar	M22 x 1.5	475 010 000 2	Merc Iveco
475 010 017 0	0.35 Bar	M22 x 1.5	475 010 000 2	Merc
475 010 300 0	8.5 Bar	M22 x 1.5 Voss	475 010 001 2	MAN
475 010 301 0	10.0 Bar	M22 x 1.5	475 010 001 2	MAN
476 010 307 0	1.8 Bar	M22 x 1.5	475 010 001 2	
475 010 310 0	4.0 Bar	M22 x 1.5	475 010 001 2	
475 010 400 0	8.0 Bar	M22 x 1.5 Voss	475 010 002 2	DAF
475 015 001 0	7.4 Bar	M16 x 1.5	475 015 001 2	Merc MAN
475 015 004 0	3.5 Bar	M16 x 1.5	475 015 001 2	Merc Iveco MAN
475 015 009 0	5.3 Bar	M16 x 1.5	475 015 001 2	Renault
475 020 006 0	4.4 Bar	M22 x 1.5		For Actros. With Silencer
475 010 333 0	9.3 Bar	M22 x 1.5 Voss		MAN TGA, TGM, TGL
475 015 061 0	7.2 Bar	M16 x 1.5	Only available in kit	kit 421 355 931 2 Excl. to ZF
421 355 931 2	7.2 Bar	M16 x 1.6		includes 475 015 061 0
475 015 014 0	3 Bar	M16 x 1.5		EBS Mech Susp - Old D EBS Trailer only

STOP LIGHT SWITCHES (Normally open, Cut in Switch)



262625



441 014 002 0



441 014 001 0 / 021 0

Part Number	Actuation Pressure	Port size	Description / Application
262625	0.34 Bar (5 psi)	1/2 NPT	Normally open General Truck / Bus
441 014 001 0	2 Bar	M12 x 1.5	Normally open General Truck / Bus N/S
441 014 002 0	1 Bar	M10 x1 tapered	Normally open General Truck / Bus
441 014 021 0	0.5 Bar	M12 x 1.5	Normally open General Truck / Bus MAN
441 014 190 0	0.15 Bar	M12 x 1.5	Normally open General Truck / Bus

LOW PRESSURE SWITCHES (normally closed, cut off)



441 014 010 0



AGA987 includes 441 014 101 0

Part Number	Actuation Pressure	Port size	Description / Application
AGA987	4.5 Bar (65 psi)	1/4" NPT	Normally closed General Truck / Bus. Supercedes: 970 100 031 1
441 014 101 0	4.5 Bar	M12 x 1.5 Fem	Normally closed General Truck / Bus M12 female Fits 6mm union
441 014 004 0	5.5 bar	M12 x 1.5	Normally closed General Truck / Bus
441 014 010 0	0.3 Bar	M12 x 1.5	Normally closed General Truck / Bus
441 014 013 0	4.0 Bar	M12 x 1.5	Normally closed General Truck / Bus
441 014 014 0	4.5 Bar	M12 x 1.5	Normally closed General Truck / Bus
441 014 015 0	5.0 Bar	M12 x 1.5	Normally closed General Truck / Bus
441 014 025 0	6.0 Bar	M12 x 1.5	Normally closed General Truck / Bus

RESERVOIRS

Part Number	Length	Diameter	Description
AGA 179 195mm	195 mm	206mm 8"	5 Litre Reservoir
051 010 004 M	355 mm	206mm 8"	10 Litre Reservoir
051 015 005 M	507 mm	206mm 8"	15 Litre Reservoir
051 020 006 M	660 mm	206mm 8"	20 Litre Reservoir
051 020 011 M	411 mm	276mm 11"	20 Litre Reservoir
051 030 011 M	579 mm	276mm 11"	30 Litre Reservoir
451 040 311 M	740 mm	276mm 11"	40 Litre Reservoir
451 060 311 M	1095 mm	276mm 11"	60 Litre Reservoir
950 405 001 0	185mm	206mm 8"	4.5 Litre Reservoir
A6741	860mm	390mm	90 Litre Reservoir 30kg "Fatboy"
1675062 M		11"	Mounting Bracket. Pair for 11"
A6104		8"	Mounting Bracket. Single for 8"
451 999 276 2		11"	Mounting Bracket Strap type
A6742			Mounting Bracket Strap 90 litre



4 x M22 Ports



451 999 276 2



1675062 M

DRAIN VALVES



934 300 003 0 / 006 0



934 301 000 0



432 511 000 0

Condensor
Drain (water trap)

Part Number	Port Thread	Description
934 300 003 0	M22 x 1.5	Manual With Pull Ring
934 300 006 0	1/2" NPT	Manual
SF1280	1/4" NPT	Manual With Pull Ring
934 301 000 0	M22 x 1.5	Automatic Repair kit: 934 301 000 2 Filter: 899 380 622 4 Diaphragm: 897 121 400 2
934 301 003 0	M22 x 1.5	Automatic Repair kit: 934 301 000 2 Filter: 899 380 622 4
432 511 000 0	M22 x 1.5	Condensor Drain valve Max 10 Bar. Merc. Repair kit: 432 511 000 2 Filter: 432 511 220 4
434 300 000 0	M12 x 1.5	Automatic. Repair kit: 434 300 000 2

RATIO VALVES / EMPTY LOAD VALVES / ADAPTER VALVES



473 300/ 301 0.....



975 001 000 0



975 002 001 0

Part Number	Port Threads	Repair Kit	Description
473 300 001 0	M22 x 1.5		Empty Load Valve. Reduces front axle braking with empty load
473 300 004 0	M16 x 1.5 M22 x 1.5		Empty Load Valve. Reduces front axle braking with empty load.
473 301 000 0	M22 x 1.5		Reducing Valve. Regulating ratio:2 :1 Application: General Truck
473 301 001 0	M22 x 1.5		Reducing Valve. Regulating ratio:1.5 :1 Application: General Truck
473 301 002 0	M22 x 1.5		Reducing Valve. Regulating ratio:1.35 :1 Application: General Truck
473 301 003 0	M22 x 1.5		Reducing Valve. Regulating ratio: 1.15 :1 Application: General Truck
975 001 000 0	M22 x 1.5		Adapter valve. Adjusting Valve 0.6 to 0.8 Bar.
975 002 001 0	M22 x 1.5		Adapter Valve. Knick feature Appl: DAF, Mercedes Benz, MAN
975 002 017 0	M16 x 1.5		Adapter Valve. Application: Mercedes Benz.

FOOT VALVES



461 315 008 0 / 004 0 / 042 0



461 319 008 0



461 315 180 0



461 319 250 0



461 319 274 0

Part Number	Port Thread	Repair Kit	Description / Application
461 307 3990	M22 x 1.5	461 307 002 2	Dual Circuit. Predominance 0.25Bar No Pedal Elbow Exhaust. Merc
461 315 008 0	8x M16 x 1.5	461 315 005 2 Week 20/2001 461 315 915 2 Week 21/2001	Dual Circuit. Predominance: 0.3Bar No Pedal Elbow Exhaust. Merc, Iveco, Scania
461 315 004 0	4x M16 x 1.5 2x M12 x 1.5	461 315 005 2 Week 20/2001 461 315 915 2 Week 21/2001	Dual Circuit. Predominance: 0.3Bar No Pedal Elbow Exhaust. Merc, Iveco, Scania
461 315 042 0	8x M16 x 1.5 2x M12 x 1.5	461 315 900 2 Week 20/2001 461 315 917 2 Week 21/2001	Dual Circuit. NO Predominance No Pedal Elbow Exhaust. Merc, Iveco, Scania
461 315 180 0		461 315 907 2 Week 20/2001 461 315 924 2 Week 21/2001	Dual Circuit. NO Predominance No Pedal Push In fittings, with silencer, Scania
461 315 263 0 NLA Use 461 315 264 0	4x M22 x 1.6	461 315 914 2 Week 20/2001 461 315 927 2 Week 21/2001	No Pedal Application: Axor. Short Silencer 39.9mm Dia 4 x M8 stud Mounting
461 315 264 0	2x M16/ 2x M22 2x M12 x 1.5	461 315 914 2 Week 20/2001 461 315 927 2 Week 21/2001	No Pedal Application: Axor. Short Silencer 39.9mm Dia 4 x M8 stud Mounting
461 317 021 0	8x M16 x 1.5		Dual foot valve with Pedal. No Gauge ports
461 319 008 0	8x M16 x 1.5 1x M12 x 1.5	461 319 007 2 Week 20/2001 461 319 908 2 Week 21/2001	Dual Circuit. Predominance: 0.3Bar No Pedal Elbow Exhaust. Integrated Empty Load function 1,5:1. Merc, DAF
461 319 018 0	8x M16 x 1.5 1x M12 x 1.5	461 319 007 2 Week 20/2001 461 319 908 2 Week 21/2001	Dual Circuit. Predominance: 0.3Bar No Pedal Elbow Exhaust. Integrated Empty Load function 2:1. Merc, DAF
461 319 250 0	4x M22 x 1.5 1x M16	461 319 004 2 Week 20/2001 461 319 905 2 Week 21/2001	Dual Circuit. Predominance : 0.4Bar Merc. Powerliner Elbow Exhaust
461 319 270 0	4x M22 x 1.5 1x M16 x 1.5	461 319 002 2 Week 20/2001 461 319 903 2 Week 21/2001	Dual Circuit. Predominance: 0.3Bar No Pedal Elbow Exh. Integrated Empty Load 2 :1. Merc Econoliner
461 319 271 0	4x M22 x 1.5	461 319 006 2 Week 20/2001 461 319 907 2 Week 21/2001	Dual Circuit. Predominance: 0.4Bar No Pedal Exhaust : Pipe Merc.
461 319 273 0/272 0	2x M22 x 1.5 3x M16 x 1.5	461 319 901 2 Week 20/2001 461 319 912 2 Week 21/2001	Long curved silencer. 69mm dia Voss 4 x M8 stud Mounting Application: Axor / Atego
461 319 274 0	2x M22 x 1.5 3x M16 x 1.5	461 319 901 2 Week 20/2001 461 319 912 2 Week 21/2001	No Pedal Small Silencer 39.9mm Dia 4 x M8 stud Mounting Application: Axor.
461 491 102 0	M22 x 1.5	461 307 002 2 Boot 897 752 670 4	Predominance: 0.25Bar
461 494 502 0	PI		Dual Circuit, Application: Renault
461 317 792 2			Treadle Assembly

FOOT VALVES Continued



470 012 000 0

Part Number	Port Thread	Repair Kit	Description / Application
461 499 005 0	4x M22 x 1.5 2x M12 x 1.5	461 499 000 2	Predominance: 0.25Bar. Dual Circuit. Actros
470 012 000 0	4x M16 x 1.5 2x M14 x 1	461 307 002 2 Kit 470 012 520 2 Slave Cylinder	Dual (Hydraulic / Pneumatic) Brake Valve with slave cylinder. Merc
467 406 102 0	3x M14 x 1.5	467 406 004 2	Hydraulic Brake Foot Valve Spool Diametre: 14mm Medium: Mineral Oil
467 406 202 0	6x M16 x 1.5 2x M12 x 1.5		Hydraulic Brake Foot Valve Spool Diametre: 20mm Medium: Mineral Oil
467 406 208 0	6x M16 x 1.5 2x M10 x 1		Hydraulic Brake Foot Valve Spool Diametre: 14mm Medium: Mineral Oil
961 106 000 0	2x M14 x 1.5	961 106 000 2	Air foot valve. Trailer control for tractors.

ROTARY HAND BRAKE VALVES

961 701 110 0 Anti-clockwise. M14 x 1.5 Thread. 3 Port.
961 701 115 0 Different Handle - Anti clockwise
961 701 100 0 Clockwise
 Application : DAF, Merc, Iveco

961 702 154 4 Guide Pin
 899 755 021 4 Roller
 ASA 5221 Service Kit



961 702 014 0 Anti-clockwise M14 x 1.5 Thread. 4 Port.
 With Test Position
MERCEDES, MAN

961 702 154 4 Guide Pin
 899 755 021 4 Roller
 ASA 5222 Service Kit (961 701....)



961 703 001 0 M14 x 1.5 Thread. With Control Port To
 Trailer 4 Port

961 703 000 2 Repair Kit
 ASA 5324 Service Kit



HAND CONTROL VALVES



961 721 000 0



961 721 004 0



961 721 045 0



961 721 040 0



961 722 232 0



961 722 252 0



961 723 017 0



961 723 019 0



961 723 104 0



961 723 100 0

Part Number	Port Thread	Repair Kit	Description / Application
961 721 000 0	M14 x 1.5	961 721 004 / 8 2	Input Pressure: 8.5 Bar. Output Pressure: 7.5 2 port Side Bar. Stroke 90o. M14 x 1.5 Thread. Mercedes Benz
961 721 004 0	M14 x 1.5	961 721 004 2	Input Pressure: 15 Bar. Output Pressure: 7.5 2 Port Side Centre Bracket Lock Position. DAF, Iveco, Scania, Volvo
961 721 008 0	1/4" NPT	961 721 004/8 2	Input Pressure: 8.5 Bar. Output Pressure: 7.5 Side Bar. 2 Port. Centre Bracket. General Truck / Bus
961 721 040 0	M14 x 1.5	961 721 004/8 2	Input Pressure: 8.5 Bar. Output Pressure: 7.5 Bar. Side Spring Return. 2 Port. Merc
961 721 045 0		961 721 004/8 2	Stroke 73° Voss. 2 Port Slide VOSS. (Left Hand Side Bracket). Without Test Position. Merc
961 722 230 0	Slide x 2	961 722 002 2	Stroke 73° Voss. 2 Port Slide VOSS. (Left Hand Side Bracket). Without Test Position. Merc
961 722 232 0	Slide x 3	Repair Kit 961 722 003 2 Service Kit ASA 6939	Stroke 73° Voss. 3 Port Slide VOSS. (Left Hand Side Bracket). With Test Position. Merc
961 722 252 0	M14 x 1.5	Repair Kit 961 722 003 2 961 722 924 2 Service Kit ASA 6939	Stroke 73°. Position 85°. 3 Port. (Left Hand Side Bracket). With Test Position. Merc, DAF Use 961 722 272 0 & Turn bracket
961 722 258 0	M14 x 1.5	Repair Kit 961 722 003 2 961 722 924 2 Service Kit ASA 6939	Stroke 73° . 3 Port. (Centre Bracket). With Test Position. Side Ports Application: Merc
961 722 264 0	M14 x 1.5	Repair Kit 961 722 004 2 961 722 924 2 Service Kit ASA 6995	Stroke 73°. 4 Port. Without Test Position. Side Bracket Application: Merc
961 722 272 0	M14 x 1.5	Repair Kit 961 722 003 2 Service Kit ASA 6939	Stroke 73°. 3 Port. (Right Hand Side Bracket). With Test Position. Application: International Use 961 722 252 0 & Turn Bracket
961 722 284 0	M14 x 1.5	Repair Kit 961 722 003 2 Service Kit ASA 6939	Stroke 73°. 4 Port (Side) Centre Bracket. Without Test Position. Merc
961 722 288 0	M16 x 1.5	Repair Kit 961 722 003 2 Service Kit ASA 6939	Stroke 73° Thread. 3 Port (Side) Right Hand Side Bracket. With Test Position. Merc Econoliner
961 722 314 0	M14 x 1.5	Repair Kit 961 722 007 2	Stroke 73° Thread. 3 Port (Side) Side Bracket. With Test Position. Scania
961 723 017 0	M16 x 1.5	961 723 004 2	Stroke 85° 2 Port (Side) Centre Bracket. Without Test Position. DAF
961 723 019 0	M16 x 1.5	961 723 000 2	Stroke 73o VOSS Ports. 2 Port (Side) Lock Position. Centre Bracket. Without Test Position replaces 9617230050 Application: MAN
961 723 100 0	M16 x 1.5	961 723 000 2	Stroke 73° VOSS 3 Port (Bottom). Centre Bracket. With Test Position. Application: MAN

HAND CONTROL VALVES Continued



961 723 118 0



961 723 125 0



961 723 203 0



961 723 405 0

Part Number	Port Thread	Repair Kit	Description / Application
961 723 104 0	M16 x 1.5	961 723 000 2	Stroke 73° with Parking Position 85° VOSS Push-in Fitting. 3 Port (Side). Centre Bracket. With Test Position, 5.5Bar . Merc
961 723 117 0	M16 x 1.5	961 723 000 2	With Control Port To Trailer. With Electrical Switch. NO Lock Centre Bracket. Application : Iveco
961 723 118 0	M14 x 1.5		Stroke 73° VOSS Push-in Fitting. 3 Port (Side). Lock Position. Centre Bracket. With Test Position. Application: MAN
961 723 124 0	M16 x 1.5		Stroke 73° VOSS Ports. 3 Port (Side) Centre Bracket. With Test Position. Application: Merc
961 723 125 0	M16 x 1.5		Stroke 73° VOSS 3 Port (Side). Lock Position with Test Position. Application: Merc Actros
961 723 203 0	M16 x 1.5	961 723 000 2	3 Ports (Bottom). 5.9 Bar Output. Centre Bracket. With Test Position. Application: ERF
961 724 204/5 0		961 724 926 2	Volvo Only Kit available to Aftermarket part numbers: 20367533 and 20367534 Volvo
961 723 213 0	M16 x 1.5		3 Ports (Bottom). With Test Position. Application: ERF
961 723 217 0	M16 x 1.5		3 Ports Stroke 73° (Side Ports). With Test Position. Application: Scania
961 723 405 0 (inverted) Normally open	M16 x 1.5	961 723 001 2 961 723 934 2	Stroke 73°. 2 Port (Bottom). Stretch Brake Centre Bracket. Without Test Position. Application: DAF, MAN
961 723 201 0	M16 x 1.5	961 723 000 2	3 Ports (Side). 5.5Bar Centre Bracket.
961 723 421 0	M16 x 1.5 Voss		Stroke 73°. 2 Port (Side). Without Test Position. Application: ACTROS MPII
961 723 426 0	M16 x 1.5		Stroke 73°. 2 Port (Side). Centre Bracket. Without Test Position. Application: MAN
262395M			TC2 hand Control dashmounted - import on request only



Part Number	Port Thread	Repair Kit	Description / Application
AGA969	1/8"		Manoeuvring Valve, Push and hold button

LOADSENSING VALVES (Mechanical)



475 710



475 713 501 0



475 722 / 720



475 800 301 0



475 604 011 0

Part Number	Port 1	Port 2	Port 4	Control Angle	Description
475 701 020 0	M22 x 1.5	M22 x 1.5		30°	Loadensing Valve Repair kit: 475 701 000 2
475 702 022 0	M22 x 1.5	M22 x 1.5		30°	Loadensing Valve Repair kit: 475 702 001 2
475 710 000 0	M16 x 1.5	M16 x 1.5	M16 x 1.5	60°	Relay Loadensing Repair kit 475 710 001 2
475 710 008 0	M22 x 1.5	M16 x 1.5	M16 x 1.5	60°	Relay Loadensing Repair kit: 475 710 001 2 Service kit: ASA5381 Roller: 475 710 130 4 Plunger: 475
475 710 012 0	M22 x 1.5	M22 x 1.5	M16 x 1.5	60°	Relay Loadensing Repair kit: 475 710 001 2 Voss MAN L2000, M2000
475 710 016 0	M22 x 1.5	M22 x 1.5	M16 x 1.5	60°	Relay Loadensing Repair kit: 475 710 001 2 Service kit: ASA5381 MAN F2000 Anti clockwise
475 710 020 0	M16 x 1.5	M16 x 1.5	M16 x 1.5	30°	Relay Loadensing Repair kit: 475 710 001 2 Service kit: ASA5381 Roller: 475 710 130 4 Plunger: 475 710 770 4 Merc
475 710 024 0	M22 x 1.5	M16 x 1.5	M16 x 1.5	34.5°	Relay Loadensing Repair kit: 475 710 001 2 ASA5381 IVECO
475 710 036 0	M22 x 1.5	M22 x 1.5	M16 x 1.5	30°	Relay Loadensing Repair kit: 475 710 001 2 Service kit: ASA5381 Roller: 475 710 130 4 Plunger: 475 710 770 4 General Truck / Trailer / Bus
475 710 042 0	M22 x 1.5	M22 x 1.5	M16 x 1.5	20°	Relay Loadensing Repair kit: 475 710 001 2 Service kit: ASA5381 Roller: 475 710 130 4 Plunger: 475 710 770 4 General Truck / Trailer / Bus
475 710 128 0	M22 x 1.5	M16 x 1.5	M16 x 1.5	30°	Relay Loadensing Repair kit 475 710 002 2 Volvo FH12 & FH16
475 710 136 0	M22 x 1.5	M22 x 1.5	M16 x 1.5	16°	Relay Loadensing Repair kit: 475 710 001 2 Service kit: ASA5381 VOSS Merc
475 713 501 0	M22 x 1.5	M16 x 1.5	M22 x 1.5	33°	No Relay. Static Valve with Arm, Cable and Spring Kit: 475 713 000 2, 475 713 710 2 Cable& spring
475 713 002 0	M22 x 1.5	M16 x 1.5	M16 x 1.5		Trailer EBS Mech Susp. Use with 475 015 014 0 limiter
475 713 002 0	M22 x 1.5	M16 x 1.5	M16 x 1.5		Trailer EBS Mech Susp. Use with 475 015 014 0 limiter
475 604 011 0	M22 x 1.5	M22 x 1.5			Manual Load Apportioning Valve
475 800 301 0	M12 x 1.5	M12 x 1.5			Truck Tag Axle Load Regulator Repair Kit 475 800 004 2
475 720 001 0	M22 x 1.5	M22 x 1.5	M16 x 1.5	30°	New Gen Relay Loadensing
475 720 003 0	M22 x 1.5	M22 x 1.5	M16 x 1.5	30°	New Gen Relay Loadensing DAF LF 45 & LF 55
475 720 004 0	M22 x 1.5	M22 x 1.5	M16 x 1.5	30°	New Gen Relay Loadensing DAF With Silencer
475 720 005 0	M22 x 1.5	M22 x 1.5	NG8 Voss	16°	New Gen Relay Loadensing

LOADSENSING VALVES (Air Suspension)



475 711



475 714 510 0



475 721 000 0 / 3 0 / 9 0

Part Number	Port 1	Port 2	Port 4	Control 41/42	Description
475 711 024 0	M22 x 1.5	M22 x 1.5	M16 x 1.5	M16	Relay Loadensing Repair kit: 475 711 000 2 Merc, Trailers with 30Ø bags Control Pressure: 0.6 to 4.3 Bar
475 711 096 0	M22 x 1.5	M22 x 1.5	M16 x 1.5	M16	Relay Loadensing Repair kit: 475 711 000 2 VOSS, MAN F2000 / M2000, DAF Control Pressure: 0.45 to 6.1 Bar
475 711 115 0	M22 x 1.5	M22 x 1.5	M16 x 1.5	M16	Relay Loadensing Repair kit: 475 711 000 2 Merc, Control Pressure: 0.45 to 6.1 Bar
475 711 118 0	M22 x 1.5	M22 x 1.5	M16 x 1.5	M16	Relay Loadensing Repair kit: 475 711 000 2 Merc, Actros Control Pressure: 0.5 to 3.0 Bar
475 714 510 0	M22 x 1.5	M22 x 1.5	M16 x 1.5	M12	No Relay Function Trailers with 36Ø or 30Ø bags Control Pressure: 0.4 to 3.6 Bar
475 721 000 0	M22 x 1.5	M22 x 1.5	M16 x 1.5	M16	Max operating Pressure 13Bar Mini LSV Voss ports Application: Merc Axor
475 721 003 0	M22 x 1.5	M22 x 1.5	M16 x 1.5	M16	Max operating Pressure 13Bar Mini LSV Voss ports No Relay Application: DAF
475 721 008 0	M22 x 1.5	NG8 Voss	NG8 Voss	M16	Max operating Pressure 10Bar Mini LSV Voss ports P4 = 6Bar Application: Merc Axor
475 721 009 0	M22 x 1.5	NG8 Voss	NG8 Voss	M16	Max operating Pressure 13Bar Mini LSV Voss ports P4 = 8Bar Application: Merc Axor

SPRING BOXES



433 302



433 306

Part Number	Length	Deflection	Force	Description / Application
433 302 002 0	260mm	100mm	20-35N	With Rubber Connector
433 302 014 0	220mm	85mm	26-47N	No Rubber Connector
433 302 008 0	160mm	55mm	40-110N	With Knuckle Connector (Ball Pivot)
433 302 026 0	220mm	85mm	49-110N	With Connector
433 302 025 0	160mm	55mm	40-110N	No Rubber Connector
433 306 003 0	260mm	100mm	60-130N	Without Knuckle Connector (Ball Pivot)

QUICK RELEASE VALVE



973 500 000 0 / 973 500 014 0



973 500 031 0



973 500 051 0

Part Number	Port 1	Port 2	Description
473 501 201 0	M22 x 1.5	M22 x 1.5 x 2	With Silencer
473 501 203 0	M22 x 1.5	M22 x 1.5 x 2	With Silencer
973 500 000 0	M22 x 1.5	M22 x 1.5 x 2	Std Trailer Diaphragm: 897 130 794 4
973 500 105 0	1/2"	Oring Seal	Freightliner - Placed between ABS solenoids
973 500 014 0	1/2"	3/8" x 2	Std Trailer No Kit Diaphragm: 897 130 794 4
973 500 031 0	M22 x 1.5	M22 x 1.5 x 2	Additional Port 22 - M16 x 1.5 5 port Diaphragm: 897 130 794 4
973 500 051 0	M22 x 1.5 x 2	M16 x 1.5 x 4	With Anti compound, double check valve For EBS trailers Diaph: 897 130 794 4

TRAILER CONTROL VALVE



973 002 000 0 / 430 0



973 002 521 0



973 009 001 0



480 204 001 / 2 0

Part Number	Port Threads	Repair Kit	Description
973 002 000 0	M22 x 1.5	ASA5741 973 002 003 2	Predominance 0.6 Bar. (Adjustable). No Dump. Application: Merc, Iveco, MAN
973 002 430 0	M16 x 1.5	ASA5741	NO Predominance. No Dump. Application: DAF
973 002 521 0	M16 x 1.5	ASA5741	With Dump feature. Predominance 0.2 Bar (Adjustable). Application; General Truck
973 009 001 0	M22 x 1.5	973 009 000 2	With Dump feature. Predominance 0.3. Bar (Adjustable). For VOSS Push- in Fitting. Application: Mercedes Benz, MAN - Powerliner
973 009 006 0	M22 x 1.5	973 009 000 2	With Dump feature. Predominance 0.0 Bar (Adjustable) P 41/42 10.5 Bar. P 11/43 8.5 Bar. For VOSS Push-in Fitting.
973 009 010 0	M16 x 1.5	973 009 000 2	With Dump. Predominance 0.2 Bar. With Silencer Application:
973 009 014 0	M16 x 1.5	973 009 000 2	With Dump. Predominance 0.4 Bar. Application: IVECO
973 009 015 0	M16 x 1.5	973 009 000 2	With Dump. Predominance 0.1 Bar. Application: Volvo
480 204 001 0	Ports 11,21,22 : M22 x 1.5 Ports 42,43 : M16 x 1.5		EBS Trailer Control Valve. Superseded by 480 204 002 0 Application: DAF, Mercedes Benz, Iveco
480 204 002 0	Ports 11,21,22 : M22 x 1.5 Ports 42,43 : M16 x 1.5		EBS Trailer Control Valve. Voss Ports. Port 6 (Electrical control). Application: DAF, Mercedes Benz - Actros, Iveco
471 401 010 0	M22 x 1.5	471 401 009 2	Referred to as a "10 S4" valve. Older vehicles

RELAY EMERGENCY VALVE



281672



471 005 020 0



971 002 150 0



971 002 300 0

Part Number	Port Threads	Repair Kit	Description
281672	Port 1: 1/4, Port 2: 3/8, Port 4: 1/4, Port1-2: 3/4	266784	Re6 Valve. Found on older trucks and trailers Application: General Truck / Trailer / Bus
471 005 020 0	M22 x 1.5	471 005 009 2	NO Predominance. Application: Trailer
971 002 150 0	M22 x 1.5	971 002 003 2	With Predominance (Adjustable). Alternative: 971 002 300 0 same except without Flange for manual LSV. Application: Trailer
971 002 300 0	Port 4: M16 x 1.5 Port 1, 1-2, 2: M22 x 1.5	971 002 008 2	With Dump feature. Predominance 0.3. Bar (Adjustable). For VOSS Push-in Fitting. Application: Mercedes Benz, MAN

SHUT OFF COCK



452 002 132 0

Part Number	Port Thread	Description
452 002 132 0.	M22 x 1.5	Park Brake. Engineering Grade Plastic Handle Supercedes: 452 002 107 0

TRAILER PARK RELEASE VALVE / PARK SHUNT VALVE



963 001 051 0



971 002 900 0

Part Number	Port Thread	Description
963 001 051 0	M16 x 1.5	Std park shunt valve
971 002 900 0	M16 x 1.5	PREV Valve Park shunt valve with relay emergency function. Application: EBS trailers
A6886		PREV Valve Information Plate 971 002

RELAY VALVE



280375



973 001 010 0 / 020 0 / 220 0



973 006 001 0 / 003 0



973 011 001 0 / 050 0



973 011 200 0

Part Number	Port Threads	Repair Kit	Description
280375	Port 1: 1/2, Port 2: 3/8, Port 4: 1/4	263945	R6 relay. Found on older trucks and trailers Application: General Truck / Trailer / Bus
473 017 001 0	Ports: M22 x 1.5		Anti Compound Square Relay Valve .
973 001 010 0	Ports: M22 x 1.5	973 001 000 2 ASA5198	Std Square Relay Application: General Truck / Trailer / Bus
973 001 020 0	Port 1: M22 x 1.5 Port 2, 4: M16 x 1.5	973 001 000 2 ASA5198	Std Square Relay Application: General Truck / Trailer / Bus
973 001 211 0	Port 1, 2: M22 x 1.5 Port 4: M16 x 1.5	973 001 006 2	Relay Valve Application: Volvo
973 001 220 0	Port 1: M22 x 1.5 Port 2, 4: M16 x 1.5	973 001 002 2	Std Square Relay Application: General Truck / Trailer / Bus
973 003 007 0	Ports: M22 x 1.5	973 003 000 2	Relay Valve Application: MAN TGA
973 006 001 0	Port 1, 2: M22 x 1.5 Port 4: M16 x 1.5		Park Brake Square Relay NO Silencer Max 10 Bar Application: Mercedes Benz, MAN
973 006 003 0	Port 1, 2: M22 x 1.5 Port 4: M16 x 1.5		Park Brake Square Relay With Silencer , Voss Threads Application: Mercedes Benz, MAN
973 011 001 0	Port 1, 2: M22 x 1.5 Port 4: M16 x 1.5	ASA7168 ASA7014	Park Brake Square Relay , Voss Threads Application: Scania, Mercedes Benz, MAN
973 011 022 0	Port 1: 1/2, Port 2: 3/8, Port 4: 1/4	ASA7168 ASA7014	With Flange For ABS Solenoid (Solenoids 472 195 082 0/30) Application: Freightliner
973 011 050 0	Port 1: M22 x 1.5 Port 2, 4: M16 x 1.5	973 011 002 2 ASA7168	Square Relay Built in Non return Application: Scania
973 011 200 0	Port 1, 2: M22 x 1.5 Port 41, 42: M16 x 1.5	973 011 000 2 ASA7168	Anti Compound Square Relay , Voss Threads, Control 10Bar Application: Scania, MAN
973 011 206 0	Port 1, 2: M22 x 1.5 Port 4: M16 x 1.5	973 011 006 2	Voss Threads. Application: Renault
973 011 300 0	Port 1, 2: M22 x 1.5 Port 4: M16 x 1.5	973 011 005 2 ASA7168	Park Brake Square Relay anti compound, Voss Threads, Control 10Bar Application: Mercedes Actros
973 011 000 0	Port 1, 2: M22 x 1.5 Port 4: M16 x 1.6	973 011 000 2 ASA7168	Relay valve park brake Application: Volvo, Scania, Renault, Iveco, Daf

LEVELLING VALVE



464 002



464 006



464 007 001 0 / 010 0

Part Number	Port Threads	Repair Kit	Description
464 002 330 0	M12 x 1.5 (3 port)	464 002 008 2	Two-stage. Nominal Diameter 2 x ø 1.3. With Arm. Application: Merc, MAN, Volvo, Trailer Steel Slide
464 002 332 0	M12 x 1.5 (3 port)	464 002 008 2	Two-stage. Nominal Diameter 2 x ø 1.3. Without Arm. Application: Merc Powerliner, MAN, Volvo Steel Slide
464 002 440 0	M12 x 1.5 (3 port)	464 002 008 2	Two-stage. Nominal Diameter 2 x ø With Arm. Application: Merc, DAF Steel Slide
464 006 002 0	M12 x 1.5 (3 port)	464 006 000 2	Two-stage. Transversal Throttle. With Linkage. Application: DAF, MAN, Volvo, Trailer Plastic Slide
464 006 100 0	3x M12 x 1.5 (5 port) 2x M16 x 1.5	464 006 001 2	Two-stage. Transversal Throttle. With Height Limitation. With Linkage. Application DAF, Trailer Plastic Slide
464 007 001 0	M6 Push in (2 port)		For suspension of driver cabin. Push-in fittings for plastic tube. Application DAF, Iveco, Scania, MAN
464 007 010 0	M10 x 1 (2 port)		For suspension of Drivers Cabin. Application: Scania
464 007 013 0	M6 Push in (2 port)		For suspension of driver cabin. Push-in fittings for plastic tube. Application DAF

RAISE / LOWER VALVE (Manual)



463 032 020 0

Part Number	Port Threads	Repair Kit	Description
463 032 020 0	Port 1: M16 x 1.5	463 032 001 2	Two-stage. Nominal Diameter 2 x ø 1.3. With Arm.
A6887			Information Plate

LINE FILTER



432 500 020 0

Part Number	Port Thread	Description
432 500 020 0	M22 x 1.5	Removable filter Application: Trailer

CLUTCH SERVOS



Part Number	Port Thread	Repair Kit	Description / Application
970 051 111 0 / 114 0 / 126 0 / 127 0	M16 x 1.5 x 2 M14 x 1.5 x 1	Repair kit: 970 051 905 2 Dust Boot: 897 754 430 4	Diameter 80.5mm. Stroke 85mm. Application MAN
970 051 114 0	M16 x 1.5 x 2 M14 x 1.5 x 1	Repair Kit : 970 051 904 2 Dust Boot: 897 754 882 4	Diameter 75mm. Stroke 67mm. Application: DAF, Hino, Iveco, Nissan, Renault-V
970 051 126 0	M16 x 1.5 x 2 M14 x 1.5 x 1	Repair Kit : 970 051 904 2 Dust Boot: 897 754 882 4	Diameter 75mm. Stroke 67mm. Force Output 4000 N. Application: DAF, Hino, Iveco, Nissan, Renault-VI
970 051 127 0	M16 x 1.5 x 2 M14 x 1.5 x 1	Repair Kit: 970 051 906 2 Dust Boot: 897 754 182 4	Diameter 100mm. Stroke 58.5mm. Force Output 6000 N. Application: Scania
970 051 128 0	M16 x 1.5 x 2 M14 x 1.5 x 1	Repair Kit : 970 051 906 2	Diameter 108mm. Stroke 58.5mm. Application: Merc Can use in place of 970 051 127 0 Only Change pushrod
970 051 131 0	M16 x 1.5 x 1 M14 x 1.5 x 1	Repair Kit: 970 051 903 2 Dust Boot: 897 754 320 4 Rear Housing: 970 051 527 2	Diameter 90mm. Stroke 72mm. 970 051 371 4 - guide Application: Merc
970 051 151 0	M16 x 1.5 x 2 M14 x 1.5 x 1	Repair Kit : 970 051 917 2	Stroke 65mm. Force Output 4000 N. Dia. 90mm Application: Merc
970 051 157 0	M16 x 1.5 x 2 M14 x 1.5 x 1	Repair Kit : 970 051 911 2 Repair Kit : 970 051 006 2	Stroke 85mm. Force Output 6000 N. Dia. 108mm MAN
970 051 159 0/158 0	M16 x 1.5 x 1 M14 x 1.5 x 1	Repair Kit: 970 051 916 2	Diameter 108mm. Stroke 75mm. Application: Merc Powerliner
970 051 164 0	M16 x 1.5 x 2 M14 x 1.5 x 1	Repair Kit : 970 051 945 2 Dust Boot : 897 754 882 4	Diameter 108mm. Stroke 85mm. Application: Merc
970 051 176 0	M16 x 1.5 x 2 M14 x 1.5 x 1	970 051 950 2	Diameter 108mm. Stroke 85mm. Use 970 051 164 0 Change Pushrod On Request
970 051 405 0	M16 x 1.5	Repair Kit : 970 051 949 2	Application: Actros Superseded to 970 051 431 0
970 051 406 0	M22 x 1.5 x 1 M14 x 1.5 x 1	Repair Kit: 970 051 952 2 Dust Boot: 897 754 430 4	Diameter 75mm. Stroke 85mm. Force Output Max 4000 N. Application: MAN
970 051 412 0		Repair Kit : 970 051 971 2 Sensor Kit: 970 051 986 2	Diam 108mm Stroke 85mm. Force Output Max 6000 N. Mineral Oil Application: MAN / TGA/ TGL/ TGM
970 051 414 0	M22 x 1.5 x 1 M14 x 1.5 x 1	Repair Kit: 970 051 961 2 Dust Boot: 897 754 882 4	Diameter 108mm. Stroke 85mm. Force Output Maxi 6000N Application: MAN F2000 With wear indicator
970 051 424 0 Note	M16 x 1.5 x 1 M14 x 1.5 x 1	Repair Kit: 970 051 961 2 Dust Boot: 897 754 882 4	Diameter 108mm. Stroke 85mm. Supply the 970 051 414 0 above WITH an M22-M16 reducer - Hino 700 Brake Fluid
970 051 431 0	M16 x 1.5	Repair Kit: 970 051 974 2 Dust Boot: 897 754 882 4	Diameter 108mm. Stroke 85mm. Force Output Max 6000N App: Merc Actros with sensor supercedes 970 051 405 0
970 051 432 0	M22 x 1.5 x 1 M14 x 1.5 x 1	Repair Kit: 970 051 977 2 Sensor:: 970 051 986 2	Diameter 80mm. Stroke 85mm. Force Output Max 4000N App: MAN TGA Mineral Oil
970 051 435 0	M16 x 1.5 x 1 M14 x 1.5 x 1	Repair Kit: 970 051 970 2	Diameter 75mm. Stroke 85mm. Force Output Maximumm 4000N With wear indicator
970 051 439 0	M16 x 1.5 x 1	Repair Kit: 970 051 984 2	Diameter 108mm Stroke 75mm. Force Output Max 6000N Application: MAN
970 051 441 0		970 051 987 2 Excl Main Seal 970 051 974 2 Incl Main Seal	Diameter: 108mm Stroke 85mm. Force Output Maximumm 6200N Mineral Oil . Application: Merc Axor
970 051 438 0	M22 x 1.5 x 1 M14 x 1.5 x 1	Repair Kit: 970 051 984 2	Diameter Stroke 75mm Application: Renault Brake Fluid
970 150 001 0		Repair Kit: 970 150 000 2	Diameter 126mm Stroke 69mm Mineral Oil MPII

SAFETY VALVES



434 612 004 0

Part Number	Port Thread	Description
434 608 220 0	M16 x 1.5	Pressure Setting 10 Bar Application: Volvo
434 612 004 0	M22 x 1.5	Pressure Setting 13 Bar Application: Merc Benz Actros
434 612 014 0	M22 x 1.5	Pressure Setting 7.5 Bar.

NON RETURN / CHECK VALVE / SHUTTLE VALVES / ONE WAY



434 014 000 0

Part Number	Port Thread	Description
434 014 000 0	M22 x 1.5	Female Ports Application: Trailer, Truck

DOUBLE CHECK VALVE / DIECTIONAL CONTROL / TWO WAY / CUT OFF VALVE



434 208 029 0

Part Number	Port Thread	Description
434 208 029 0	M22 x 1.5	Female Ports With mounting bracket.Application: Trailer, Truck

THROTTLE CHECK VALVE (3/2 Way Valve) Exhaust Brake Valve



463 013 111 0



463 013 210 0



463 022 020 0

Part Number	Port Thread	Repair Kit	Description
463 013 111 0	M12 x 1.5	ASA 5705	Stroke 5.7mm. Length 39.6mm. Without Lock Nut. General Truck short stem
463 013 112 0	M12 x 1.5	ASA 5705	Stroke 5.7mm. Length 37.9mm. Without Lock Nut. General Truck short stem
463 013 114 0	M12 x 1.5	ASA 5705	Stroke 5.7mm. Length 37.9mm. Without Lock Nut. General Truck long stem
463 013 116 0	M12 x 1.5	ASA 5705	Stroke 5.7mm. Length 46.9mm. With Lock Nut. DAF, Iveco short stem
463 013 121 0	M12 x 1.5	ASA 5705	Stroke 5.7mm. Length 75.6mm On Request
463 013 130 0	M16 x 1.5	ASA 5705	Stroke 5.7mm. Length 37.9mm. Without Lock Nut. Merc short stem
463 013 200 0	M12 /M16 x 1.5	ASA 5705	Stroke 10mm. Length 41mm. Without Lock Nut. Merc short stem
463 013 210 0	M12 /M16 x 1.5	ASA 5705	Stroke 5.7mm. Length 37.9mm. Without Lock Nut. Merc short stem
463 022 020 0	M10 x 1		Stroke 12.5mm. Length 42mm. With Lock Nut. DAF, Volvo
891 500 464 4	M26		Locknut Loose
811 401 100 4	M26		Washer Loose

GEARBOX CONTROL VALVES (3/2 Way Valve)



463 036 001 0 / 010 0
3/2 way



463 037 001 0
4/2 way



463 039 006 0
3/2 way



463 063 002 0 / 003 0
5/2 way



563 020 000 0
3/2 way



571 003 104 0
5/2 way



571 040 000 0
3/2 way



463 031 102 0

472 260 005 0 / 011 0

Part Number	Port Thread	Repair Kit	Description
463 031 102 0		463 031 001 2	4/2 way, Directional Control Valve.
463 036 001 0	M10 x 1.5		3/2 way, With Turning Knob. With Retaining Position. Without Lock Nut. Merc
ASA5910	M10 x 1.5		3/2 way - same as 463 036 001 0 but with Washer and Locknut
463 036 024 0	M10 x 1.5		3/2 way - Push button Type No Washer and Locknut
463 036 010 0	M16 x 1.5		3/2 way, Without Turning Knob. With Retaining Position. VOSS. Without Lock Nut.
463 036 016 0	M16 x 1.5 Voss		Diff Lock Switch. With switch. Nominal Diameter 4mm. Mounting M28 x 1.5
463 037 001 0	M10 x 1.5		4/3 way, Nominal Diameter 2.5mm. M10. Without Handle and Lock Nut. Merc
463 038 009 0		463 038 000 2	3/2 way, Directional Control Valve. With Pressure switch
463 039 006 0	M10 x 1	463 039 000 2	3/2 way, Without switch. Merc
463 063 002 0	M10x1/ M12x 1.5	463 063 000 2	5/2 way, Nominal Diameter 1.5mm. Merc, ZF Box P2= RHS
463 063 003 0	M10x1/ M12x 1.5	463 063 000 2	5/2 way, Nominal Diameter 1.5mm. MAN, ZF Box P2= LHS
472 260 005 0	M22 x 1.5		Proportional Valve VOITH
472 260 011 0	M22 x 1.5 Voss		Proportional Valve VOITH
563 020 000 0	M10 x 1		3/2 way, NW4 MAN
571 003 104 0	M10 x 1		4/2 way, NW4 Control pressure 2Bar. DAF, Mercedes Benz, Iveco, MAN
571 040 000 0	M14 x 1.5		3/2 way, Trailer suspension, raise lower & axle lift, General Truck
899 851 810 4			Handle for 463 037 001 0
891 500 520 4			Lock nut M28
A5821			Washer M28

SERVO UNIT

921 399 025 0 Pneumatic Assist Hydraulic Servo

Hydraulic Pressure: 120 Bar.
Pneumatic Pressure: 8 Bar.

60cm3 Cylinder with Air Reservoir.

Application: Iveco



974 010 008 0 Pneumatic Assist Hydraulic Master Servo

Supercedes 974 010 006 0

Hydraulic Pressure: 45 Bar.
Pneumatic Pressure: 6 - 10 Bar.

Mineral Oil

Application: MAN TGL



SOLENOID VALVE



472 090 202 0



472 127 140 0



472 170 600 0



472 172 686 0



472 176 316 0



472 172 600 0

Part Number	Port Thread	Description
472 090 202 0	1/4" NPT	24V Normally closed. Nominal Diameter 2.8mm. General Truck and Bus
472 070 639 0	M16 x 1.5 Voss	24V Normally closed. Nominal Diam 4mm. DIN Bayonet. Merc
472 072 628 0	M12 x 1.5	3/2 Way. Nominal Diam. 2,2/3. Type: Normally Closed
472 102 040 0	M12 x 1.5	12/24V Normally open
472 127 140 0	M12 x 1.5	12/24V Normally closed. Nominal Diam 2.2mm. Terminals. MAN, General Truck, Trailer
472 132 198 0	M12 x 1.5	Nominal Diam. 2,2/3. Type: Vented 24V Norm Closed
472 170 600 0	M12 x 1.5	24V Normally closed. Nominal Diam 4mm. M27x1 Kostal. Merc, ERF
472 170 637 0	M12 x 1.5	12V Nominal Diam. 2,2/3. normally closed
472 172 600 0	M12 x 1.5	24V Normally closed. Nominal Diam 2.2mm. M27x1 Kostal. DAF, Iveco, Trailer
472 172 620 0	M12 x 1.5	Nominal Diam. 2,2/3. Type: Normally closed
472 172 626 0	M12 x 1.5	24V Nominal Diam. 2,2/3. Type: Normally closed
472 172 686 0	M12 x 1.5	24V Normally closed DAF
472 174 504 0	M12 x 1.5	24V Normally closed. 2/2 Type Bayonet
472 173 700 0	M12 x 1.5	24V Nominal Diam. 4.0. Type: Normally Open
472 176 316 0	M16 x 1.5	Nominal Diam. 4.0. Type: Normally Open Actros and DAF
472 195 000 0		Use 472 195 018 0 + cable 894 601 132 2 (adaptor M24 to Bayonet)
472 123 706 0		Use 472 172 620 0 24V

PROPORTIONAL VALVES



Part Number	Port Thread	Description
472 260 005 0	M22 Voss	Truck and Bus
472 260 011 0	M22 Voss	Truck and Bus
472 250 000 0	M12 x 1.5	24V 8bar max. Speed limiter and ASR controller Closed M27x 1 connector

OPERATING CYLINDERS



421 411 070 0



421 429 003 0



421 429 002 0



422 010 012 0



421 411 314 0

Part Number	Port Thread	Description
421 411 070 0	M12 x 1.5	35mm Diam. Stroke 38mm. With Yoke 8mm. Mercedes Benz, ERF, Iveco, MAN
421 429 003 0	M12 x 1.5	28mm Diam. Stroke 48mm. Without Yoke. Mercedes Benz, MAN, Toyota, Nissan
421 411 300 0	M12 x 1.5	35mm Diam. Stroke 85mm.
421 411 314 0	M12 x 1.5	35mm Diam. Stroke 35mm
421 429 002 0	M10 x 1.0	28mm Diam. Stroke 70mm.
421 444 002 0	M12 x 1.5	20mm Diam. Stroke 15mm
421 445 001 0	1/4" NPT	32mm Diam. Stroke 54mm
ASA6620		Cylinder actuator assembly

DOOR CONTROL VALVES

472 017 480 0 Conventional Door Control

24 Volt. Normally Open or Closed
8 Bar. M12 Ports.

Application: Mercedes Benz, Iveco, MAN

Repair Kit 472 017 000 2



SILENCERS



432 407 060 0



432 407 070 0

Part Number	Port Thread	Description
432 407 060 0	M22 x 1.5	Screw On. Max Pressure 13 Bar, Foot Brake
432 407 070 0		Snap On. Max Pressure 11 Bar, Foot Brake, Load sensing valves etc
432 407 016 0		Saw - Tooth Profile

PALM COUPLINGS



952 200 021 0



952 200 022 0



952 200 221 0



952 200 222 0

Part Number	Port Thread	Description
952 200 021 0	M16 x 1.5	Red Cap, Trailer Emergency - No Valve
952 200 022 0	M16 x 1.5	Yellow Cap, Trailer Service - No Valve
952 200 221 0	M16 x 1.5	Red Cap, Truck Emergency - With Valve
952 200 222 0	M16 x 1.5	Yellow Cap, Truck Service - With Valve
897 550 020 4		Replacement seal

DUOMATIC COUPLINGS



452 802 009 0



452 804 012 0

Part Number	Port Thread	Description
452 802 009 0	M16 x 1.5	Truck Coupling. Maximum 10 Bar Repair kit: 452 802 003 2
452 804 012 0	M16 x 1.5	Trailer Coupling. Maximum 10 Bar
897 550 020 4		Replacement seal

F&J COUPLINGS



Part Number	Port Thread	High Spec	Description
0520010022	1/2"	0520010022D	Female std
A6722	M22 x 1.5	A6722D	Female with striker plug assembled Trailer
APSA1519	1/2"	APSA1519D	Female with striker plug assembled Trailer
0520010062	1/2"	0520010062D	Female F&J with short stem shut off valve Truck No dust flap or bracket
0520003005	M16 x 1.5	0520003005D	Female F&J with short stem shut off valve Truck No dust flap or bracket
ASA531/2	1/2"	ASA531/2D	Female F&J with short stem shut off valve Truck With dust flap and bracket
0520010032	1/2"	0520010032D	Short stem Shut off valve only

0520000014	1/2"	0520000014D	Male Coupling std Trailer
0520000024	M22 x 1.5	0520000024D	Male Coupling std Trailer
0520030052	1/2"	0520030052D	Male F&J with long stem shut off valve Truck No dust cap or brack
A6704	M22 x 1.5	A6704D	Male F&J with long stem shut off valve Truck No dust cap or bracket
0520001005	M16 x 1.5	0520001005D	Male F&J with long stem shut off valve Truck
0520030062	1/2"	0520030062D	Male F&J with long stem shut off valve Truck With dust cap and bracket
0520030012	1/2"	0520030012D	Long stem Shut off valve only
0520030112	M22 x 1.5	0520030112D	Long stem Shut off valve only

AP11168	1/2"	AP11168D	Striker Plug / Operating Plug
A5776	M22 x 1.5	A5776D	Striker Plug / Operating Plug
SF240/4	1/2"		Copper Washer

0520030022			Dust cover (Female dummy) for male couplings with Chain and bracket
0520030142			Dust Flap Nylon for Female Couplings
1178075			Dust Plug male for female couplings with chain and bracket
A1121			Service Tag
A1122			Emergency Tag
0520030152			Plastic Mounting Bracket

AIR THROTTLE VALVES



361 064 050 0



423 020 016 0

Part Number	Port Thread	Description
3610500002		Repair kit
3610640500	M14 x 1.5	Air Throttle Valves
4230200160	M12 x 1.5	T3 Throttle Actuator
8971210304		Type 3 Diaphragm fro T3 chamber
8965144404	NLA	Spring (A6601)

BRAKE CHAMBERS



Part Number	Port Thread	Pic	Description	
AGA339	1/4"	A	T 12, Short stroke	
AGA109		A	T 20, Short stroke	
AGA448	M16 x 1.5	A	T 24, Long stroke old number AGA351	
AGA449	M16 x 1.5	A	T 30, Long stroke, with nuts, clevis and washers old number AGA354	
423 107 900 0	M16 x 1.5	B	T 30, Long stroke, rod protrusion 85mm long, without clevis, nuts and washers	
423 105 111 0	M16 x 1.5	C	T20, 37mm Rod Protrusion. With Yoke and Gaiter. Merc	Stroke 75mm
423 106 292 0	M16 x 1.5	C	T24, 116mm Rod Protrusion. With Yoke and Gaiter. Merc	Stroke 75mm
423 106 900 0	M16 x 1.5	B	T24, 186mm Rod Protrusion. No yoke.	Stroke 75mm
423 109 001 0	M16 x 1.5	C	T27 37mm Push Rod	Stroke 64mm
423 206 700 0	M16 x 1.5	D	T24. 37mm Piston Rod. Welded Yoke. No Mounting Studs.	Stroke 57mm
423 206 701 0	M16 x 1.5	D	T24. 37mm Piston Rod. Welded Yoke. No Mounting Studs.	Stroke 57mm
425 307 012 0	M22 x 1.5	F	100mm diam Release 4.5bar M16 push rod kit 425 307 000 2	Stroke 80mm

SPRING BRAKES WEDGE TYPE



A

Part Number	Port Thread	Pic	Description
425 451 052 0	3/8"	A	T24/24. Wedge Type Right Hand Side
425 451 053 0	3/8"	A	T24/24. Wedge Type Left Hand Side

SPRING BRAKES

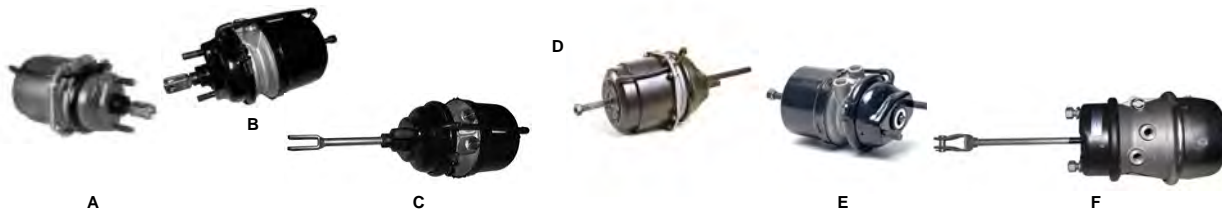

Part Number	Port Thread	Pic	Description
925 320 502 0	M16 x 1.5	A	T20/30. 30mm Piston Rod. With Yoke and Gaiter. Rep Kit 9253200022 (S/S 925 490 755 0)
925 323 125 0	M16 x 1.5	E	T36/30. 15mm Push Rod. Without Yoke. Repair Kit 925 320 002 2 (S/S 925 494 0410 0)
925 324 040 0	M16 x 1.5	B	T16/24. 60mm Welded Push Rod. Repair Kit 925 320 001 2 (S/S 925 490 902 0)
925 326 000 0	M16 x 1.5	A	T14/12 With Yoke and Gaiter
925 420 902 0	M22 x 1.5	A	T20/24. 37mm Welded Push Rod. Voss ports. Repair Kit 925 320 001 2 s/s 925 490 902 0
925 421 540 0	M22 x 1.5	B	T24/30 G-Type Welded Push Rod Stroke 65mm
925 421 715 0	M16 x 1.5	B	T24/24. 200mm Welded Push Rod. Repair Kit 925 321 007 2 NLA (S/S 925 421 752 0)
925 421 751 0	M22 x 1.5	D	T24/24. 200mm Welded Push Rod. MAN F2000 (S/S 925 491 755 0)
925 424 100 0	M22 x 1.5	C	T16/24. 187mm Rod Length. With Yoke. VOSS Ports. Welded Rod.Merc (S/S 925 494 041 0)
925 426 200 0	M22 x 1.5	E	T14/16. 15mm Push Rod. Disc Brake. Repair Kit 925 426 000 2 LHS
925 426 201 0	M22 x 1.5	E	T14/16. 15mm Push Rod. Disc Brake. Repair Kit 925 426 000 2 RHS

SPRING BRAKES Continued

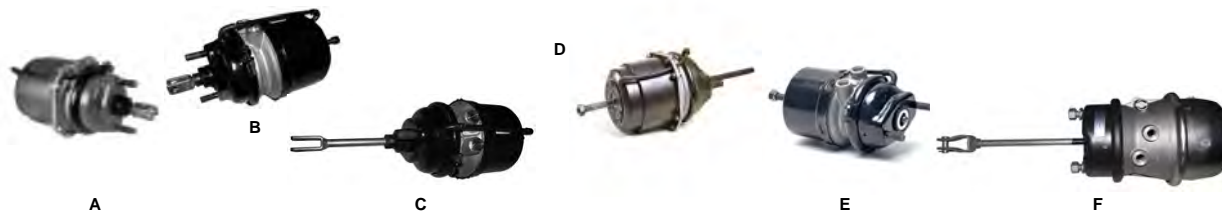

Part Number	Port Thread	Pic	Description
925 450 001 0	M16 x 1.5	D	T20/24. 250mm Push Rod. Without Yoke. VOSS Ports. Superseded by 925 490 925 0
925 451 001 0	M16 x 1.6	D	T24/24. 250mm. Without Yoke. With Gaiter. M16 x 1.5 Rod. Superseded by 925 491 141 0
925 452 001 0	M16 x 1.7	D	T30/30. 250mm. Without Yoke. With Gaiter. M16x1.5 Rod. DAF, Scania, Volvo s/s 925 492 102 0
925 454 001 0	M16 x 1.8	D	T16/24. 200mm. Without Yoke. With Gaiter. M16 x 1.5 Rod. Merc, MAN s/s 925 494 041 0
925 424 800 0	M22 x 1.5	E	T16/16. 15mm Rod Length. VOSS Ports. Left Hand Side. MAN
925 424 801 0	M22 x 1.5	E	T16/16. 15mm Rod Length. VOSS Ports. Right Hand Side MAN
925 461 470 0	M16 x 1.5	E	T24/30. 15mm Rod Length. Stroke 65mm
925 480 004 0	M22 x 1.5	E	T20/24. 15mm Push Rod. Disc Brake. RHS
925 488 012 0	M22 x 1.5	E	T14/24. 15mm Push Rod. Disc Brake. RHS
925 488 021 0	M22 x 1.5	E	T14/24. 15mm Push Rod. Disc Brake. RHS
925 492 102 0	M22 x 1.5	D	T30/30. 250mm Push Rod. Universal Tri-Stop. No Yoke.
925 494 041 0	M22 x 1.5	D	T16/24. 250mm Push Rod. Universal Tri-Stop. No Yoke. (S/S 925 494 960 0)
925 481 012 0	M16 x 1.5	E	T24/24. 65mm Stroke. VOSS Ports RHS
925 481 013 0	M16 x 1.5	E	T24/24. Push Rod 15mm VOSS Ports. Merc Actros. LHS
925 468 013 0	M16 x 1.5	E	T14/24. Push Rod 15mm VOSS Ports. Merc Actros. Superseded by 925 488 015 0 LHS
925 468 020 0	M16 x 1.5	E	T14/24. Push Rod 15mm VOSS Ports. Merc Actros. Superseded by 925 488 020 0 RHS
AGA262	3/8"	F	T12/12 trailers & mine machinery Pushrod 12mm
AGA445	M16 x 1.5	F	T24/30 Long stroke horizontal studs trailers Pushrod M16 1/2" Clevis old number AGA349
AGA446	M16 x 1.5	F	T24/30 Long stroke Vertical studs trailers Pushrod M16 1/2" Clevis old number AGA349A
AGA447	M16 x 1.5	F	T30/30 Long stroke trailers Pushrod M16 1/2" Clevis old number AGA350
AGA430	M16 x 1.5		T24/24 925 491 141 0 with clevis, washers and pushrod lock nut
AGA431	M16 x 1.5		T20/24 925 490 925 0 with clevis, washers and pushrod lock nut
AGA432	M22 x 1.5		T16/24 925 494 041 0 with clevis, washers and pushrod lock nut

SPRING BRAKE SPARES

DOUBLE DIAPHRAGM SPARES

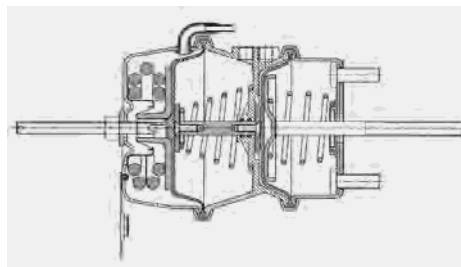
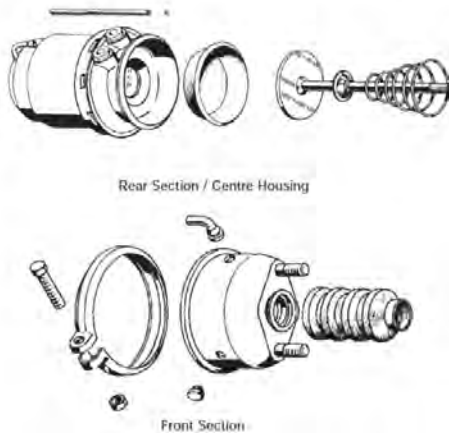

Part Number	Description	Part Number	Description
895 801 513 2	M16 x 14mm Clevis and Pin.	A 5948	Centre Seal Kit.
897 750 980 4 ID12	Dust Boot. 1 Hole (Small) L=100mm W=45mm	ASA 1779	T24 Push Rod Not for AGA349
897 751 010 4 ID21	Dust Boot. 1 Hole (Large) L=100mm W=45mm	ASA 1780	T30 Push Rod.
897 753 261 4 ID35	Dust Boot. 2 Hole L=85mm W=45mm	ASA 5267	5/8" Clevis x 1/2" Pin.
925 321 010 2	Type 24 Rear Housing (Steel).	ASA6868	5/8" Clevis x 1/2" Pin (Long)
925 322 011 2	Type 30 Rear Housing (Steel).	ASA 6294	Clevis M16 x 1.5mm x 1/2" Pin.
A5803 ID40	Dust Boot Maxi		
ASA6194	Maxi Booster Kit		

DIAPHRAGMS



Part Number	Description
897 121 030 4	Wabco Type 3. OD:78.6mm Depth 22mm
234433M	Type 9. OD: 130mm
234226M	Type 12.
897 121 610 4	Wabco Type 14. OD: 147mm Depth 33mm
A6447	Type 16.
897 120 510 4	Wabco Type 16. OD: 156mm Depth 35mm
A6448	Type 20. OD: 169.7mm Depth 28.7mm
897 120 520 4	Wabco Type 20. OD: 168mm Depth 33mm
A2400	Type 24. OD: 180mm Depth 29mm
897 120 530 4	Wabco Type 24. OD: 179mm Depth 33mm
897 120 536 4	Wabco Type 24. Deep dish
897 121 925 4	Wabco Type 27.
A3000	Type 30. OD: 203mm Depth 32mm
897 120 540 4	Wabco Type 30. OD: 199mm Depth 35mm
897 120 546 4	Wabco Type 30. OD: 200mm Depth 44mm
234362M	Type 36.
897 120 516 4	Type 16 Deep Dish

LOADSENSING & LEVELLING VALVE COMPONENTS



A 5349 LSU



ASA 5080/5081



433 300 381 4 (STR)
433 300 383 4 (L)



464 002 730 2 (Levelling Valve)
475 701 712 2 (L.S.V.)

Part Number	Description
A 5349 LSU	Coiled Spring Arm for loadsensing
A 5426	Bracket (Springbox Mounting / Single Axle).
A 5427	Bracket (Springbox Mounting / Tandem Axle).
A 6356	Data Plate - Air Suspension Valve / Mechanical
ASA 5080	Linkage Kit Tandem Axle.
ASA 5081	Linkage Kit Single Axle.
433 300 381 4	Axle Linkage Connection 8mm (Rubber Straight). Loadsensing Valve
433 300 383 4	Axle Linkage Connection 8mm (Rubber L Shape). Loadsensing Valve
433 300 384 4	Link Connection 6mm (Rubber L Shape). Levelling Valve
433 300 385 4	Link Connection 6mm (Rubber L Shape) Levelling Valve
433 401 003 0	Axle Linkage Kit. Levelling Valve. Clamp 893 510 470 2
433 401 004 0	Double Axle Linkage Kit Buffer Kit
433 401 380 4	Link Connection 6mm (Rubber Straight). Levelling Valve No Clamp
464 002 730 2	Metal Arm (464 002...0) Levelling Valve. Includes straight rubber
475 701 712 2	Straight Load Sensing Arm with Rubber Link.
475 710 130 4	Roller (475 710...0). Load Sensing Valve.
475 710 770 4	Plastic Plunger (475 710...0). Load Sensing Valve.
441 050 718 2	Flat Bar Levelling Valve arm for 464 002 532 0
475 713 710 2	Arm and Cable with spring for 475 713 Loadsensing Valve
898 011 350 4	Dust Cover / Cap (475 710...0). Load Sensing Valve.
899 144 631 4	Data Plate - Air Suspension Valve.
A6434	Single Rubber Buffer with steel threaded rod
A5347	Bottom Linkage Elbow and mounting nuts

SUZY COILS



Air Suzy



7 & 15 pin Suzy



7 & 15 pin Plug
A6699 & A6701



7 & 15 pin Socket
A6698 & A6700

Part Number	Description
ASA 5477	Red with Springs and 1/2" NPT Fittings. DIN Specification 73378.
ASA 5478	Yellow with Springs and 1/2" NPT Fittings. DIN Specification 73378.
AGA347	Electrical Male to Male 7 pin ISO 7638 ABS/EBS suzi
AGA348	Electrical Male to Male 15 pin ISO 12098 suzi
A6700	Lighting 15 PIN ISO SOCKET Female Easy connector type
A6701	Lighting 15 PIN ISO PLUG Male Easy connector type
A6698	ABS/EBS 7 PIN ISO Socket Female Easy connector type
A6699	ABS/EBS 7 PIN ISO Plug Male Easy connector type
A6624	ABS/EBS 7 Core ADR Cable

NYLON PIPE

Part Number	Description
A 5766	04 Black.
A 6115	04 Blue.
A 6232	04 Green.
A 6114	04 Red.
A 6119	06 Blue.
828 251 908 6	06 Black.
A 6038	06 Red.
A 6041	06 Yellow
A 6245	06 Green
A 6241	08 Blue
828 251 907 6	08 Black.
A 5914	08 Red
A6244	08 Yellow
A 5912	08 Green
A 6599	09 Black.
A 3005/N/10SB	010 Blue.
828 251 906 6	010 Black
A 3005/N/10R	010 Red.



DIN Specification 73378 or 74324.

Part Number	Description
A 3005/N/10SY	010 Yellow.
A 5405	010 Green.
A 5606	011 Black (Push on).
A 5635	012 Blue.
A 5633	012 Green.
A 5608	016 Black (Push on).
A 5782	012 Black.
A 5632	012 Red.
A 5634	012 Yellow.
A 5607	013 Black (Push on).
828 251 904 6	015 Black

RUBBER HOSE

A3626	1/2" Bore Rubber Hose Working pressure 15.5 Bar DIN: SAE J1402.
-------	---

INSTALLATION ACCESSORIES

AGA 322	Nylon Pipe Cutter
A 900	Spiral Binding 25m lengths
899 700 001 4	8mm Nylon Pipe Extraction tool plastic
899 700 002 4	12mm Nylon Pipe Release tool plastic
899 700 003 4	15mm Nylon Pipe Release tool plastic
899 700 012 4	8mm Nylon Pipe Release tool stainless steel
899 700 014 4	12mm Nylon Pipe Release tool stainless steel
899 700 015 4	15mm Nylon Pipe Release tool stainless steel



Stainless Steel release tool



Plastic Release Tool

TRUCK EBS COMPONENTS



446 130 014 0 / 015 0



480 001 000 0



480 001 011 0



480 103 011 0



480 202 005 0



480 204 001/2 0

Part Number	Port Thread	Description
446 130 014 0		EBS ECU (Electronic Control Unit) 4x2, 1999, with EPS/EAS. Application: Merc Actros Diagnostic Software: 246 301 547 0
446 130 015 0		EBS ECU (Electronic Control Unit) 4x2, 6x2, 6x4, 8x4. Not 4x2 tractors. 1999, with EPS/EAS. Application: Merc Actros Diagnostic Software: 246 301 547 0
446 130 053 0		EBS ECU (Electronic Control Unit) Application: Merc Actros Diagnostic Software: 246 301 547 0
480 001 000 0	All ports: M22 x 1.5 Port 4 M16 x1.5	Brake Signal Transmitter Without Silencer. With port 4 VOSS Application: Merc Actros
480 001 010 0	M22 x 1.5 Voss	Brake Signal Transmitter With Silencer. With Port 4VOSS Application: Actros
480 001 011 0	All ports: M22 x 1.5	Brake Signal Transmitter With Silencer. 2003. Without port 4 VOSS. Application:
480 001 400 0	M22 x 1.5 Voss	Brake Signal Transmitter Without Silencer. Without port 4 Application:
480 001 500 0	M22 x 1.5 Voss	Brake Signal Transmitter With Silencer. Without port 4 Application:
480 003 000 0	All ports: M22 x 1.5 Port 4 M16 x1.5	Brake Signal Transmitter With Silencer. Without port 4 Application:
480 103 011 0	M22 x 1.5	EBS Axle Modulator. 4x2. 1999. Application: Merc Actros / Axor
480 103 012 0	M22 x 1.5	EBS Axle Modulator. 6x2, 6x4, 8x4. 1999 Application: Merc Actros Diagnostic Software: 246 301 547 0
480 103 015 0		EBS Axle Modulator. 4x2. 2004
480 103 016 0		EBS Axle Modulator. 6x2. 2004. Application: All vehicles except 4x2
480 103 055 0		EBS Axle Modulator 6x2 Application: Merc Actros
480 104 003 0		EBS Axle Modulator. DAF
480 202 004 0	All ports: M22 x 1.5 Port 4: M16 x1.5	Proportional Relay Valve. Front Axle. All vehicles except 8x4
480 202 005 0	All ports: M22 x 1.5 Port 4: M16 x1.5	Proportional Relay Valve. Front Axle. For 8x4 vehicles. Replaces 8840135030 Application: DAF 85
480 204 001 0	M22 x 1.5	EBS Trailer Control valve. Reworked 7 pin Bayonet fitting plugged from below, Superseded by: 480 204 002 0 Application: DAF, Merc Actros, Nissan Not Available
480 204 002 0		EBS Trailer Control valve. Reworked 7 pin Bayonet fitting plugged from below, Superseded by: 480 204 002 0 Application: DAF, Merc Actros, Nissan
480 103 042 0	All ports: M22 x 1.5 Port 4: M12 x1.5	EBS Axle Modulator. DAF
480 103 033 0		EBS Axle Modulator. Nissan
480 104 002 0	All ports: M22 x 1.5 Port 4: M16 x1.5	EBS Axle Modulator. Nissan (4760-001207)
480 104 106 0		EBS Axle Modulator MAN 2005
446 135 003 0		EBS ECU Nissan UD (4789.01273)
446 210 001 0 446 210 006 0	Use	CVC Central Vehicle Controller MAN

TRUCK ABS COMPONENTS



446 004 064 0



446 004 313 0 / 416 0



446 004 335 0



472 195

Part Number	Description
446 004 064 0	ABS/ASR - C3 4S/4M. 24v. Engine Interface, EDC/EMS. Application: DAF, Dennis, Nissan
446 004 416 0	4S/4M. 24V. D Engine Interface. Application: MAN F2000 / Bus Diagnostics Software: 246 301 628 0
446 004 335 0	E Generation ECU. Basic ABS with ASR. Application: UD Nissan, Hino 700/500 Diagnostics Software: 246 301 628 0
472 195 006 0	24V ABS Solenoid Valve. Connector Kostal M24 x 1, 1/2" ports Application: Older Trucks with ABS
472 195 016 0	24V ABS Solenoid Valve. Electric Connector Bayonet. M22 x 1.5 VOSS Port.
472 195 018 0	
472 195 052 0	12V ABS Solenoid Valve. Electric Connector: Bayonet. 1/2"-14 NPTF dry seal
472 195 082 0	12V ABS Solenoid Valve. Electric Connector Kostal M24 x 1, 1/2"BSP ports Left Hand Side Flange Mounted Application: Freightliner
472 195 083 0	12V ABS Solenoid Valve. Electric Connector Kostal M24 x 1, 1/2"BSP ports Right Hand Side Flange Mounted Application: Freightliner
446 044 200 0	ABS ECU
446 056 127 0	24V ECAS Remote Control Unit
449 423 060 0	Solenoid Cable 6m
449 423 080 0	Solenoid Cable 8m
449 423 120 0	Solenoid Cable 12m
449 715 120 0	Truck Sensor cable 12M
449 715 080 0	Truck Sensor cable 8M
894 601 133 2	Adapter Cable Din to Bayonet

TRUCK ECAS (Electronically Controlled Air Suspension)



472 900 060 0



463 084 010 0



446 056 116 0



441 050 011 0 /012 0



441 040 007 0 / 015 0



472 880 001 0

Part Number	Description
472 900 053 0	For Rear Axle with 2 Height Sensor. 3 Solenoids. 1 Electrical Connection. Bayonet. M22 x 1.5 VOSS Push-in Fitting. With Silencer. Application: DAF, MAN, Repair Kit : 472 900 009 2 Same as 472 900 060 0 but with Plug
472 900 060 0	For Rear Axle with 2 Height Sensor. 3 Solenoids. 1 Electrical Connection. Bayonet. M22 x 1.5 VOSS Push-in Fitting. With Silencer. Repair Kit : 472 900 009 2. NO Plug but Same as 472 900 053 0
472 905 111 0	ECAS Solenoid valve drive and lift axle M22 Kit 472 905 004 2 DAF MAN TGA AXOR
473 905 114 0	ECAS Solenoid valve drive and lift axle M22 2x silencers Bayonet connector
472 880 001 0	ECAS Solenoid replaces 472 900 053 0
446 056 116 0	ECAS Remote control Hand held Truck only
446 056 202 0	ECAS Remote control Hand held Universal
446 056 010 4	Mounting bracket for remote control
446 170 208 0	ECAS ECU Unit
441 050 011 0	ECAS Height Sensor. Bayonet without Lever. Height Sensor. Application Mercedes Benz, DAF, MAN
441 050 012 0	ECAS Height Sensor. Bayonet without Lever. Without Temperature Compensation. Application: Merc, MAN
441 050 100 0	ECAS Height Sensor. Bayonet with Lever. Without Temperature Compensation.
472 880 000 0	ECAS Solenoid Valve use 472 880 030 0 AXOR RA, DAF Iveco
441 040 007 0	ECAS Pressure Sensor M16 x1.5 Bayonet 400 mV/Bar (16 Counts/Bar) Appl: Mercedes, DAF, Iveco, MAN, Scania, Trailer
441 040 015 0	ECAS Pressure Sensor. M16 x 1.5 Bayonet. 400 mV/Bar (16 Counts / Bar). With O ring
441 043 504 1	Pressure Sensor
441 050 123 0	ECAS Height Sensor
441 100 531 2	Distance Sensor Module

EBS & TCE TRAILER COMPONENTS



480 102 014 0 / 015 0



480 207 001 0



446 122 001 0

Part Number	Description
C Version EBS	
971 002 802 0	EBS Relay Emergency Valve C Version EBS OLD system. Use 9710028050 below with kit
971 002 805 0	EBS Relay Emergency Valve rep. 9710028020 C Version. Use with 9710029212 or 9710029222 see date of valve
449 472 080 0	EBS CABLE to REV C Version EBS OLD system Use with 9710029212 or 9710029222 see date of valve
D Version EBS	
480 102 015 0	EBS D ECU VALVE WITH RSS WITH TCE replaces 4801020020 4S3M
480 102 010 0	EBS D ECU VALVE NO RSS NO TCE Basic EBS 4S2M
480 102 014 0	EBS D ECU VALVE WITH RSS NOT FOR TCE 4S3M
480 207 001 0	EBS 3rd Modulator Relay Valve for trailers
441 040 015 0	Pressure Transducer used with ECAS and TCE replaces 4410400070 24V 10 Bar max
449 752 030 0	Pressure Transducer Cable 3m to EBS from transducer 4410400150 for drawbars D -Ver EBS and old EBS
449 752 100 0	Pressure Transducer Cable 10m to EBS from transducer 4410400150 for drawbars D -Ver EBS and old EBS
449 823 020 0	Pressure Transducer Cable to TCE x44 from 4410400150 for ECAS
449 372 130 0	EBS 3rd Modulator Cable
449 672 030 0	DIAGNOSTIC PLUG CABLE 3m
449 172 120 0	ELECTRICAL SUPPLY CABLE with ISO6738 7pin Female socket 12m
449 272 100 0	ELECTRICAL SUPPLY CABLE with ISO6738 7pin Male socket 10m
449 684 313 0	ELEC SUPPLY (stoplight) & diagnostic cable 12m (replaces normal diag cable) NOT ISO7638
449 172 150 0	ELECTRICAL SUPPLY CABLE with ISO6738 7pin Female socket 15m
ASA7118	15 EXTENDED POWER CABLE WITH MALE FOR DRAWBARS
449 377 030 0	Smartboard cable to D gen EBS
446 192 110 0	Smartboard EBS with battery (Not ADR Compliant)
TCE Components	
446 122 001 0	TCE computer UNIT Supercedes 446 122 000 0
449 113 120 0	POWER SUPPLY CABLE x13 on TCE 15PIN
446 122 400 0	PARK Distance Controller sensor TCE
449 704 253 0	TCE To Park Dist Control sensor Cable 6m 2 split x31
449 672 040 0	TCE Diagnostic Cable x14
449 399 020 0	TCE To EBS Cable x22
449 655 050 0	ECAS/ELM fixed keypad cable to TCE board X41 use fixed mount box 4461560100
446 156 010 0	Fixed control keypad Box Mounted on vehicle
449 392 075 0	Cable for rear lighting with 15 pin ISO Socket
TCE ECAS Air Susp Control Parts	
472 900 055 0	ECAS Air Susp Control Valve NO axle lift
449 483 015 0	TCE To ECAS Cable x43
446 056 202 0	Remote control keypad Hand held TRAILER
449 635 050 0	TCE to IRCU Unit Cable x41
441 050 012 0	Height Sensor Unit Without Arm
449 814 228 0	Height Sensor Cable to TCE 3m x42
Additional EBS Trailer Parts (non electronic parts)	
971 002 900 0	PREV Valve - Trailer Park Release Valve with relay emergency feature
973 500 051 0	Quick Release Valve M22 & M16 del Anti compound valve. Port 12 to Prev valve
434 500 003 0	Select Low valve for Steering Axle control instead of using a solenoid
ASA6960	EBS data plate Calculation Information for EBS software

EBS E GENERATION TRAILER COMPONENTS



480 102 063 0



441 050 100 0



446 192 110 0 or 446 192 100 0



472 905 111 0/114 0



472 880 001 0

480 102 030 0	2S/2M Premium 4 GIOs - Mech Susp & Int Air susp Without PEM
480 102 060 0	4S/3M Premium 7 GIOs - Mech Susp & Int Air susp
480 102 063 0	4S/3M Premium 7 GIOs - Mech Susp & Int Air susp & PEM & Fittings
481 102 080 0	4S/2M Premium 7 GIOs - MultiVoltage ABS/EBS with RSS Without PEM
449 173 120 0	Power Cable ISO 7638 Semi - Female 12m
449 273 120 0	Power Cable ISO 7638 Drawbar - male 12m
449 349 150 0	Stoplight Power cable 15m
449 723 030 0	Sensor extension cable 3m
449 723 100 0	Sensor extension cable 10m
480 207 001 0	EBS 3rd Modulator Relay Valve 24V
472 195 031 0	EBS 3rd Modulator Relay Valve Multivoltage Same as VCSII Valve
449 429 080 0	3rd modulator cable to EBS E
449 436 030 0	3rd modulator cable to EBS E
449 611 030 0	Diagnostic cable E-EBS 3m
441 050 100 0	Distance Sensor Unit Without Arm for height control and on Mechanical suspension
449 811 000 0	Distance sensor Connecting cable for EBS E
472 880 001 0	ECAS Air Susp Control Valve NO axle lift
472 905 111 0	ECAS Air Susp Control Valve with Axle Lift and Optiturn - 1 point control
472 905 114 0	ECAS Air Susp Control Valve with Axle Lift and Optiturn - 2 point control
449 443 040 0	Single Circ Axle lift Cable 4m
894 601 135 2	Dual Circuit Axle Lift Cable
446 192 110 0	Smartboard EBS with battery (Not ADR Compliant)
446 192 100 0	Smartboard EBS without battery (ADR Compliant)
449 911 040 0	Smartboard Cable to EBS E



463 090 023 0
TASC Valve



446 122 070 0
ELEX



446 122 401 0/402 0
Park Distance Sensor



446 122 080 0
Remote Control

TASC ELEX & Park Distance Control Components	
463 090 023 0	TASC Valve
449 623 253 0	Cable from ABS to TASC Valve with diagnostic plug 6m/6m
450 443 060 0	Cable from EBS E to TASC Valve 6m
446 122 070 0	ELEX ECU
449 303 020 0	Cable from ELEX to EBS Valve Subsystems plug
449 908 060 0	ELEX-Cable to ISO 12098
446 122 401 0	Park Distance ultrasonic sensor 0 degrees
446 122 402 0	Park Distance ultrasonic sensor 15 degrees
449 806 060 0	Sensor Cable to ELEX
894 600 024 0	Splitter cable for Sensors
446 122 080 0	Truck Remote control for trailer ELEX system
General Components	
899 200 922 4	Sticky Silver Foil Data Label
893 129 467 4	Push in to 1/2" Hose barb

SENSORS & ABS ACCESSORIES



441 032 808 0



441 032 921 0



899 760 510 4

Part Number	Description
449 712 023 0	2,3m Sensor Ext Cable Std Truck or Trailer
449 712 038 0	3,81m Sensor Ext Cable Std Truck or Trailer
449 712 051 0	5,1m Sensor Ext Cable Std Truck or Trailer
449 032 905 0	ABS Sensor BPW Disc Caliper
441 032 808 0	Sensor and cable 0.4m tail 90° Application: DAF, Merc, Trailer
441 032 823 0	Sensor Type S Plus. 2m tail 90° Application: Merc Actros
441 032 851 0	Sensor Type S Plus. 1.5m tail 90° Application: Merc Actros
441 032 082 0	Sensor S - Type Truck 3.5m 90°
441 032 920 0	Sensor S - Type Truck Straight 2.5m
441 032 921 0	Sensor S - Type Truck Straight 3.0m
441 100 110 0	EDS Distance Sensor - Exclusive to FTE Automotive
A6609	Warning Light Green round 12/24V LED
895 905 155 4 NLA	Pole Wheel (For Henred and Go Axles Only) Not Available from WABCO
899 760 510 4	Sensor Bush
ASA 6241	Mounting Block

TRAILER PNEUMATIC SUSPENSION & ECAS (Electronically Controlled Air Suspension)



4741000010



463 084 010 0



463 084 020 0



463 084 041 0



446 056 202 0

Part Number	Description
463 084 020 0	Full Pneumatic Automatic Axle Lift Valve. Valve factory set at Air bag pressure: 1.5Bar lift Axle 4.2Bar lower
449 664 190 0	EBS D Axle lift valve cable for Single Axle lift Valve 4630840300 4m / 4m diag
449 664 253 0	EBS D Axle lift valve cable for Single Axle lift Valve 4630840300 6m / 6m diag
449 443 040 0	EBS E Single Circ Axle lift Cable 4m
894 601 135 2	EBS E Dual Circuit Axle Lift Cable
463 084 030 0	Single circuit Axle lift Valve
463 084 041 0	Single circuit Axle lift Valve NEW with push in fittings 8mm
463 084 010 0	EBS D Dual axle lift valve. Split left and right of trailer M16 x 1.5 / M22 x 1.5
449 624 113 0	EBS D Axle lift valve cable for dual axle lift 4630840100
449 554 113 0	EBS D Diag / ELM / Single circuit Axle lift Cable 6m/2m/2m
474 100 001 0	ELM (Electronic Leveling Module) M16 x 1.5
449 344 253 0	Power cable from EBS ECU to ELM with EBS diagnostic plug
449 340 153 0	Power cable from ABS ECU to ELM + diagnostics
446 056 202 0	Remote control keypad Hand held TRAILER
446 156 010 0	Fixed control keypad Box Mounted on vehicle
449 633 060 0	Remote control Cable to remote control hand held
446 056 010 4	Mounting bracket for remote control
449 638 060 0	Remote control Cable from ELM to remote control Box Mounted on Vehicle
441 050 718 2	Flat arm for ELM and ECAS height valve

TRAILER ABS COMPONENTS



VCSI
400 500 035 0 / 050 0



VCSII
400 500 081 0 / 083 0



472 195 031 0



434 500 003 0

Part Number	Description
TRAILER PARTS VCS I	
400 500 035 0 NLA	24V ECU 4S/3M mixed Power supply stoplight power required with permanent power for diagnostics
400 500 050 0 NLA	12V ECU 4S/3M Permanent Power supply required for ABS to function, stoplight power optional
449 411 140 0 NLA	3rd modulator cable 14m
472 195 041 0	24V Bayonet. Boxer Valve. Double-ABS-Relay Valve. M22 x 1.5
449 314 257 0	Stoplight Power/Diagnostic cable 12/6 VCSI ABS
449 332 120 0	Constant Power Cable 12m No socket or plug VCSI ABS
449 332 140 0	Constant Power Cable 14m No socket or plug VCSI ABS
449 612 030 0	Diagnostic plug only
TRAILER PARTS VCS II	
399 500 070 0	24V ECU 2S/2M Only ABS VCS II Mixed Power Supply
400 500 081 0	24V ECU 2S/2M or 4S/2M or 4S/3M ABS VCS II Mixed Power Supply
400 500 083 0	12V ECU 2S/2M or 4S/2M or 4S/3M ABS VCS II Mixed Power Supply
449 616 158 0	VCSII 3rd Modulator 15m Cable AND DIAGNOSTIC CABLE 3m
449 616 153 0	VCSII 3rd Modulator 6m Cable AND DIAGNOSTIC CABLE 3m
449 134 337 0	12m 7 Pin Y-Supply Cable ISO 7638 & ISO 1185 WITH FEMALE SOCKET - Semi Trailers (Stoplight and constant power)
449 234 337 0	12m 7Pin Y-Supply Cable ISO 7638 & ISO 1185 WITH MALE SOCKET -Drawbar Trailers (Stoplight and constant power)
449 615 030 0	Diagnostic Cable 3m preferred usage
449 615 060 0	Diagnostic Cable 6m
446 008 310 4	ISO 7638 Socket Pins 1,5
446 008 311 4	ISO 7638 Socket Pins 6,0
449 374 323 0	5 Pin Y cable - Semi and Drawbar Trailers (Stoplight supply only) 12m
Lengthening cables	
449 384 333 0	6m Y-Supply Cable ISO 7638 & 12m ISO 1185 lengthen ISO cable with either 4491331200 or 4492331000 below
449 384 328 0	3m Y-Supply Cable ISO 7638 & 12m ISO 1185 lengthen ISO cable with either 4491331200 or 4492331000 below
449 133 120 0	12m 7 Pin ISO 7638 WITH FEMALE SOCKET join to 4493843330 above - Semi Trailers
449 233 100 0	10m 7 Pin ISO 7638 WITH MALE PLUG join to 4493843330 above - Drawbar Trailers
ASA7075	Superceded 14m 7 pin Extended Power Cable ISO 7638 & ISO1185 with Female socket - LONG SEMI TRAILERS
ASA7080	Superceded 14m 7 pin Extended Power Cable ISO 7638 & ISO1185 with Male socket - DRAWBAR TRAILERS
COMMON ABS PARTS FOR VCSI AND VCSII	
472 195 031 0	24V 3rd Modulator Valve, Electrical Connector: Bayonet Ports: M22 x 1.5 (Old No. 472 195 020 0)
472 195 033 0	12V 3rd Modulator Valve, Electrical Connector: Bayonet Ports: 3/4" supply, 3/8" delivery, signal
434 500 003 0	Select Low valve for Steering Axle control instead of using a solenoid
ABS and General Plates and Labels	
A6259	Sticky label "WABCO ABS"
A6602	Aluminium label "WABCO ABS" same text as A6259
A6389	Welding warning plate (This old plate now replaced by plate below A6621)
A6621	Diagnostics instruction data Plate replaces A6389
A6622	24V connector Plate
A6623	12V connector Plate
A6274	Diagnostics plate, next to diagnostic plug
A6627	A4 "Do not Weld Sticker ABS on Vehicle"
A6607	Torque to 210Nm plate for spring brakes
A6356	LSV Data Plate

DIAGNOSTIC EQUIPMENT



GENERAL EQUIPMENT		
AGA658		Laptop, Diagnostic Interface II & Carry Case
4463010300	A	Diagnostic Interface 2 & PC USB cable S/S 4463010220
4463004300	B	Truck and Trailer ABS Handheld Tester & Hydraulic ABS
4463004000	B	Trailer Handheld ABS Tester C, VCS I and VCSII



TRAILER DIAGNOSTIC CABLES		
4463003292	C	K line Cable Trailer VCSI VCSII TCE EBS - Blue Diag plugs
4463003480		5V CAN Cable - Yellow Diagnostic trailer plug (IVTM)
4463003600	F	Inter Adapter ISO7638 CAN Cable use with 446 300 361 0
4463003610	E	24V CAN Cable CAN use with 446 300 360 0
4460562020	G	ELM Keypad



TRAILER SOFTWARE		
4463015100		Trailer VCSII Software USB Stick
4463015420		Trailer EBS D Software USB Stick
4463015890		Trailer EBS E Software USB Stick
4463016920		ODR - Operating Data Recorder Software USB Stick

TRUCK DIAGNOSTICS CABLES		
4463004040	H	ABS/ASR D vers. Inter-Adapter Cable MAN A63 bus
4463004080	I	ABS/ASR E vers. Inter-Adapter Cable Hino Toyota
4463004530		DAF EBS Cable
4463004540	J	OBD - EBS (EPB) Cable MPII Actros, Axor, defender
4463004560		ECAS Diagnostic Cable
4463004600		OBD - 15 pin Cable for DAF, Scania, MAN
4463003270		ABS, ECAS Inter Adaptor 35Pin Old version Truck
4463003170		ECAS / ATC Inter adapter 25pin
4463003440		EBS Euro/ Asia Vehicles OLD Nissan UD
4463003400	K	EBS / ECAS (EPB) Cable (Actros Axor) old cable
4463003450		ZBR II MAN cable (TGA MAN ECAS etc)
4463003490		IVECO EBS Cable



H



I



J



K

TRUCK DIAGNOSTICS SOFTWARE		
4463016280		D+ ABS E Gen Software Hino Toyota
4463016240		ABS SAE D Gen Software Freightliner
4463018980		EBS 1C Asia Software UD trucks
4463015470		EBS EPB Software for Mercedes (Actros)
4463016820		Diagnostic Software for Trailer TCE
4463015450		Diagnostic Software for Truck EBS (Europe)
4463015560		Diagnostic Software for Truck EBS (Asia)
4463015720		Diagnostic Software HPB BAE software
4463018740		Diagnostic Software ENR Actros/Merc ECAS
4463006570		ZBR II MAN Software TGA MAN

Pipe Extractor Tools		
899 700 001 4	8mm	Nylon Pipe Extraction tool plastic
899 700 002 4	12mm	Nylon Pipe Release tool plastic
899 700 003 4	15mm	Nylon Pipe Release tool plastic
899 700 012 4	8mm	Nylon Pipe Release tool stainless steel
899 700 014 4	12mm	Nylon Pipe Release tool stainless steel
899 700 015 4	15mm	Nylon Pipe Release tool stainless steel

TEST EQUIPMENT PNEUMATIC



453 004 007 0



AGA 211

Part Number	Description
453 004 007 0	Pressure Gauge. 16 Bar. M16 x 1.5. Diameter (100mm).
AGA 211	Pressure Gauge. 10 Bar. Dash Mount. Diameter (60mm).
ASA 5896*	Test Hose 6m Long with Wing Nuts.
118 938 6	Test Gauge kit: 2x gauges, 2x hoses 6m , fittings and couplings and test pts
A6918	Wing Nut for Test Gauge Hose

FITTINGS CATALOGUE

GENERAL/ COMPRESSION FITTINGS

1	UNIONS	16	SOCKETS
2	ELBOW UNIONS	17	STEEL WASHERS
3	TEE UNIONS	18	ADAPTERS
4	BULKHEADS STRAIGHT	19	TEST CONNECTORS
5	O - RINGS	20	REDUCERS
6	THRUST RINGS	21	COPPER WASHERS
7	ALUMINIUM WASHERS	22	STRAPS
8	KORS (UNION SWIVEL ADAPTERS)	23	PIPE NUTS
9	NIPPLES	24	CUTTING RINGS
10	LINE CONNECTORS	25	STEEL PIPES
11	HOSE TAILS	26	PIPE CLAMPS
12	NYLON INSERTS		
13	PLUGS		
14	LOCKNUTS		
15	BOLTS		

1 UNIONS			
893 800 294 0	M10 -06	ASA6548	1/8"BSP-08LL
893 800 304 0	M10 -08	893 800 354 0	1/4"BSP-010
ASA6794	M10 -12	893 800 371 0	1/4"BSPT-06
893 800 014 0	M12 -06	893 800 904 0	1/4"NPT-08
893 800 234 2	M12 -08	893 801 314 0	1/4"NPT-012
893 800 044 0	M12 -010	ASA1790	3/8"NPT-010 (S)
893 800 984 0	M12 -012	ASA5208	3/8"NPT-012
893 800 064 0	M14 -06	ASA5530	1/2"NPT-010
893 800 244 0	M14 -08	ASA5182	1/2"NPT-012
893 800 073 0	M14 -010	ASA930	1/2"NPT-012 (BR)
1677039	M14 -012	ASA5315	1/2"NPT-015
893 809 010 0	M16-06	ASA5366	1/2"BSP-012B/H
893 809 020 0	M16-08	ASA959A	1/4"BSP-06
893 801 994 0	M16-010	ASA1025	3/8"NPT-015
893 800 974 0	M16-012	ASA1009	1/2"-012 B/H Brass
893 800 022 0	M22 -06	ASA931	1/2"NPT-012
893 800 224 0	M22 -08	ASA5128	1/2"BSP-012
893 800 109 0	M22 -010	ASA952	1/4"NPT-06
893 800 964 0	M22 -012	ASA5806	1/8"NPT-06
ASA1250	M22 -016	ASA6729	1/8"NPT-1/4"PIPE
893 800 033 0	M22-015 Long nut and body	893 800 134 0	3/8"NPT-010
ASA5223	M22-015 Short nut and body	A6196	3/8"BSP-08
ASA555	M22 -1/2"	ASA6766	1/4"NPT-1/4"PIPE
893 800 264 0	M26-015 Long Nut and Body		
ASA7077	M26-015 Short Nut and Body		
893 800 254 0	M26-018 Long Nut Stoss		
ASA6223	M12X1-08		
893 800 008 2	M22-012		
893 800 033 0	M22-015 Long nut and body		

2 ELBOWS			
8938300140	M12-06	ASA5313	1/4"NPT-012
8938301040	M12-08	ASA2013	3/8"BSP-010
ASA6503	M16-08	ASA2014	3/8"BSP-012
893 830 214 0	M16-012 B/H	ASA963	1/4"NPT-012
8938307700	M22-08 B/H	ASA1235	1/4"NPT-06
8938302040	M22-012 B/H	ASA6728	1/2"NPT-010
8938300420	M22-015	ASA1435	3/8"NPT-012
8938300910	M26-015 LONG NUT B/H	ASA965	1/2"NPT-012 Brass
8938900630	M22(male)-M22(Female)	ASA5312	1/2"NPT-012 Steel
ASA5225	M22-015 SHORT NUT	ASA6579	1/4"NPT-08
ASA1261	06SW-06	ASA964	3/8"NPT-012
ASA1476	08SW-08	ASA1237	1/8"NPT-06
ASA1342	010SW-010	ASA1374	1/8"NPT-08
ASA1258	012SW-012		
8938400340	06-06 B/H		
ASA1263	08-08 B/H		
ASA1262	010-010 B/H		
8938401040	012-012 B/H		

3 TEE			
8938600140	06-06-06	ASA1336	06SW-06-06
8938601440	08-08-08	ASA1345	06-06SW-06
8938600530	010-010-010	ASA5443	08SW-08-08
8938603740	012-012-012	ASA5242	08-08SW-08
8938600940	015-015-015	ASA1504	010SW-010-010
8938601940	08-06-08	ASA1348	010-010SW-010
8938603940	012-06-012	ASA1260	012SW-012-012
8938503240	M22-012-012	ASA1259	012-012SW-012
8938503940	M22-M22-012	ASA5258	012SW-06-012
ASA969	012-1/4"(F)-012	ASA5207	012SW-TEST-012
ASA5956	012-08-012	893 850 314 0	012-M22-012
A844	1/4"(F)-1/4"(F)-1/4"(F)	ASA6279	Hyd Test M12x1
A636	1/4"(M)-1/4"(F)-1/4"(F)	893 500 044 4	M22-M22-M22
A637	3/8"(M)-3/8"(F)-3/8"(F)	221979	1/4"-1/4"-1/4"
ASA5414	1/8"(M)-1/8"(F)-1/8"(F)		
8938506600	M16-012-012		
A1012	1/2" HOSE TEE Steel		

4 BULKHEAD STRAIGHT			
8938213900	06-06	8938212340	M16-012
ASA5255	08-08	8938212240	M22-012
8938201600	010-010	8938212440	M22-015
8938205740	012-012	8931039004	M16-M22
8938900140	M22-M22		
8938900400	M22-1/2"BSP		

5 O-RINGS		6 THRUST RINGS	
8970711104	M12	893 030 070 4	M12
8977700704	M14	893 030 080 4	M14
8977702504	M16	893 030 170 4	M16
8970804004	M22	893 030 040 4	M22
8977705304	M26	893 030 090 4	M26
		893 030 014 4	M15

7 ALUMINIUM WASHERS		8 KORS (SWIVEL)	
8114010084	M6	ASA5252	08-06
8114011724	M10	ASA5259	010-06
8114010324	M12	ASA1267	012-06
8114010454	M14	ASA1351	012-08
8114010574	M16	ASA1350	012-010
8114010664	M18	ASA5398	016-06
8114010804	M22	ASA5490	016-012
8114011004	M26		

9 NIPPLES			
8931000354	M22-M22 Hex	A60	1/4"NPT - 1/4"NPT
8931001644	M22-1/2"BSP	A6217	1/2"NPT - 1/2"NPT
8931800344	M16 (Male)-M22 (Female)		

10 LINE CONNECTORS		11 HOSE TAILS	
8938200120	06-06	A24	3/8"NPT - 1/2" HOSE - short Fir tree
8938201340	08-08	A6735	3/8"NPT - 1/2" HOSE Steel Replaces A24
8938200240	010-010	A646	M22 -1/2" HOSE
8938205640	012-012	A588	Adapter hose stem pipe 12mm- 1/2"
ASA5231	015-015 short nut replaces 8938200610	A25	1/4"BSPT - 1/2" HOSE
8938205740	012-012 B/H	A23	1/2"BSPT - 1/2" HOSE
8938200700	015-015 short nut B/H	8931294462	M22 - 1/2" Hose Tail with Oring
ASA5261	016-016 Short Nut	8931204144	M16 - 1/2" Hose Tail
8938200840	018-018 Long Nut	8931294452	M16 - 1/2" Hose Tail with Oring
ASA5237	018-018 Short Nut	A588	Standpipe 12mm - 1/2"Hose Tail
205514	1/4"-1/4"	A6199	Standpipe 12mm - 1/2"Hose Tail
ASA6188	1/4"-1/4"B/H		

12 NYLON INSERTS			
8930402104	06 X 1.5	246088	1/4"
8930402204	08 X 1.5	246089	3/8"
8930402304	10 X 1.5	246090	1/2"
8930402404	12 X 1.5		
8930402504	15 X 1.5	ASA5974	04mm
8930402604	18 X 1.5		

13 PLUGS			
8109030084	M10	A6113	1/8"BSP
8930100304	M12	A174	1/8"NPT
8930100104	M14	A31	1/4"NPT
8930100114	M14	A30	3/8"NPT Brass
8930117104	M16	A29	1/2"NPT Brass
8930117114	M16	A27	1/2"BSP
8109040044	M16 Fine Thread	A28	3/4"NPT
8930100204	M22		
8930102304	M26		
8930220144	M16 With O ring		
8930220154	M22 With O ring		

14 LOCKNUTS		15 BOLTS	
5000110	M5	5000186	M5x25mm
5000484	M6 NYLOC	5000240	M6x18mm
A6001	M8 NYLOC	5000242	M6x20mm
5000112	M8	5005520	M6x45mm
5000113	M10	5000253	M8x1.25x35mm
8103150024	M12	5000250	M8x20mm
8103150034	M14	5000141	M10x20mm
8103150044	M16	A5668	M12x1,5mm Air Dryer
8103040314	M16 BOOSTERS	A5669	M12x1,75mm Reservoir
8103150054	M18	A5999	M8x60mm
8915004544	M22	A6000	M8x25mm
8915004644	M26		
8915005204	M28		

16 SOCKETS			
8932402244	M12	W103/8	1/2"NPT BRASS
8933000124	M22 SHORT	ASA5595	1/4"
8933000114	M22 LONG	A6056	M22 -1/2"NPT

17 STEEL WASHERS		18 ADAPTERS	
5000222	M6 FLAT	A6112	1/2"(M)-3/8"(F)
5000131	M8 FLAT	ASA6251	06L TAIL ONLY
5000122	M10 FLAT	ASA5405	08L TAIL ONLY
A5872	M18 FLAT	893 180 184 4	M22 (M)-1/2" (F)
8951049304	M26 FLAT	893 180 274 4	M16 (M)-1/2" (F)
5000582	M5 SPRING	893 180 034 4	M16(M) - M22(F)
5000583	M6 SPRING		M16-M22
5000584	M8 SPRING		
5000585	M10 SPRING		
5000587	M14 SPRING		
8104200104	M16 SPRING		
A5821	M28 FLAT		

19 TEST CONNECTOR		20 REDUCERS	
4637051020	1/4"NPT MALE	A5379	M16 - 3/8"NPT
4637031060	M14 FEMALE	A5414	M16 (M) - 1/4" (F)
ASA5254	M16 FEMALE	A5414	M16 (M) - 1/4" (F)
4637031140	M16 MALE	A5379	M16 (M) - 3/8" (F)
4637031070	M18 FEMALE	893 104 066 4	M16 (M) - M12 (F) With O ring
ASA5867	VOSS TEST POINT	893 104 051 4	M22 (M) - M12 (F) With O ring
8937839404	RUBBER DUST BOOT COVER	893 104 052 4	M22 (M) - M16 (F) With O ring
ASA6279	HYD TEST TEE	A499	M22 (M) - 3/8"NPT (F)
ASA7096	08-TP-08 TEE	A498	M22 (M) - 1/4"NPT (F)
463 703 116 0	M12 MALE	A673	M22 (M) - 1/2"NPT (F)
		893 180 880 4	M26 (M)-M22 (F)
		A34	3/4"NPT (M) - 1/2"NPT (F)
		A35	1/2"-3/8"
		A36	3/8"NPT (M) - 1/4"NPT (F)
		A39	1/2" (M) - 1/4" (F)
		A672	1/2"NPT (M) - M22 (F)
		A6181	1/4"NPT (M) - 1/8" (F)

21 COPPER WASHERS		22 STRAPS	
A5764	M12	A900	Clear Spiral Binding
A5371	M14	A900/B	Black Spiral Binding
A5530	M16	A1134	Plastic Straps 200mm (100Qty)
A5531	M18	A6153	Plastic Straps Heavy Duty 395mm (50Qty)
SF240/4	1/2"		

23 PIPE NUTS		24 CUTTING RINGS	
8930700544	06	893 050 014 4	06
8930701044	08	893 050 054 4	08
8930700744	010	893 050 024 4	010
8930708344	012	893 050 144 4	012
8930701744	015 SHORT	894 050 034 4	015
8930700654	015 LONG	A5554	016
8930700844	018 LONG	893 050 040 4	018
		A488	012 Brass

25 STEEL PIPES		26 PIPE CLAMPS	
8201205016	08	893 511 110 4	06
8201205046	010	893 511 030 4	08
8201105046	012 (PHOS.)	893 510 990 4	010
8201105036	012 (GALV.)	893 511 000 4	012
A3005/BU/6MM	06 BUNDY TUBE	893 511 010 4	015
8201205726	015 (PHOS.)	893 511 020 4	018
8201205816	015 (GALV.)	A5370	1/2" Hose Clamp
8201205736	018 (GALV.)	A3626	1/2" Hose Clamp
A3005/S/16MM	016	A6720	20-22mm Bolt clamp Best
A5851	016 STAINLESS	A6183	1/2" Hose Clamp
A3005/BU/12MM	012 BUNDY TUBE		

PUSH IN FITTINGS

1	STRAIGHT UNIONS	11	BULKHEAD UNIONS
2	MALE BULKHEAD BARREL TEE BLOCK	12	BULKHEAD ELBOWS
3	MALE BULKHEAD STUD BLOCK	13	TEES
4	MALE BULKHEAD ELBOW BLOCK	14	BRANCH TEES (ASSEMBLED)
5	FEMALE TEE BLOCK	15	BARREL TEES (ASSEMBLED)
6	MALE BULKHEAD TEE BRANCH BLOCK	16	TEST POINT TEES (ASSEMBLED)
7	SCREW THREAD WITH SWIVEL PLUG	17	LINE CONNECTORS
8	SWIVEL PLUG ELBOW	18	VEE NUTS
9	SWIVEL PLUG BARREL TEE	19	O-RINGS
10	SWIVEL PLUG BRANCH TEE	20	THRUST RINGS
		21	VARIOUS

1 STRAIGHT UNIONS

893 803 035 0	M10 - 6mm (N (M10x1 thread)
893 803 022 0	M12 - 6mm (alternative 4100916M)
893 803 023 0	M16 - 6mm
893 803 024 0	M22 - 6mm
893 803 025 0	M10 - 8x1 mm (M10x1 thread)
893 800 007 2	M12 - 8x1 mm (8938034900, 4100888M) **
893 800 001 2	M16 - 8x1 mm (8938035400, 4100911M) **
893 800 005 2	M22 - 8x1 mm (8938034000, 4100913M) **
893 800 002 2	M16 - 12x1.5 mm (8938034300, 4100915M) **
893 800 008 2	M22 - 12x1.5 mm (8938034400, 4100914M) **
893 800 004 2	M22 - 15x1.5 mm (8938037800, 4101056M) **
893 803 420 0	M22 - 10x1 mm
893 803 410 0	M16 - 10x1 mm
893 803 990 0	M26 - 15x1.5 mm
893 800 005 2	M16 - 16 x 1 **
	** This type of fitting has pipe removable using a tool below
899 700 001 4	8mm Nylon Pipe Extraction tool plastic
899 700 002 4	12mm Nylon Pipe Release tool plastic
899 700 003 4	15mm Nylon Pipe Release tool plastic
899 700 012 4	8mm Nylon Pipe Release tool stainless steel
899 700 014 4	12mm Nylon Pipe Release tool stainless steel
899 700 015 4	15mm Nylon Pipe Release tool stainless steel

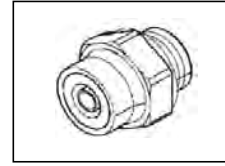

Plastic Tool

Stainless Steel

2 MALE BULKHEAD BARREL TEE BLOCK

893 851 400 0	M22-M16F-M16F * (alternative 4101087M)
893 851 390 0	M16-M16F-M16F * (alternative 4101086M)
4101083M	M12-M12F-M12F
	* WITH Lock nut, Thrust ring and O ring

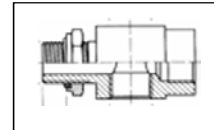

3 MALE BULKHEAD STUD BLOCK

4101005M	M22 / M22 - M16F B/H stud * (alternative 8931042962)
4101017M	M16 / M22 - M16F B/H stud * (alternative 8931042972)
	* WITH Lock nut, Thrust ring and O ring

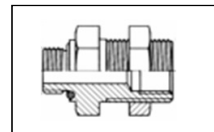

4 MALE BULKHEAD ELBOW BLOCK

893 401 008 4	M12 - M12F B/H Elbow stud *
893 401 292 4	M16 - M16F B/H Elbow stud *
893 401 770 4	M22 - M16F B/H Elbow stud *
893 890 450 0	M22 - M22F B/H Elbow stud *
4101105M	M22-M16F B/H Elbow stud
4101098M	M12-M12F B/H Elbow stud
4101102M	M16-M16F B/H Elbow stu
	* WITHOUT Lock nut, Thrust ring and O ring

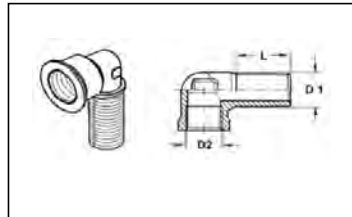

5 FEMALE TEE BLOCK

4100994M	M12F - M12F - M12F TEE Block (alternative 8935010054)
893 501 191 4	M16F-M16F-M16F TEE BLOCK (alternative 4100993M)
893 501 197 4	M22-M22F-M22F TEE BLOCK (alternative 4101198M)

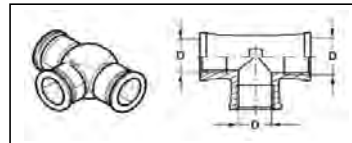

6 MALE BULKHEAD TEE BRANCH BLOCK

890 159 586 4	M16F -M22 - M16F TEE Branch *
4101096M	M16F-M22-M16F TEE BRANCH (alternative 8901595864 *)
4101095M	M16F -M16 - M16F TEE Branch (alternative 8935010014 *)
4101091M	M12F -M12 - M12F TEE Branch (alternative 893 501 006 4 *)
A6605	3/8M - 1/4F - 3/8F TEE Branch (replaces A36 & A637)
A6606	M16M -1/4F - 3/8F TEE Branch
	* WITHOUT Lock nut, Thrust ring and O ring

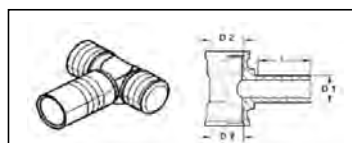

7 SCREW THREAD WITH SWIVEL PLUG

893 920 342 4	M 10x1 Swivel Plug P5 (893 920 827 2)
893 129 191 2	M 12x1.5 Swivel Plug P5
893 129 192 2	M 16x1.5 Swivel Plug P5
893 129 193 2	M 22x1.5 Swivel Plug P5

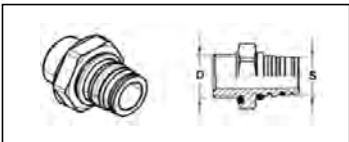

8 SWIVEL PLUG ELBOW

893 401 827 2	M12x1.5 Elbow for P5 plug
893 401 015 2	M 16x1.5 Elbow for P5 plug

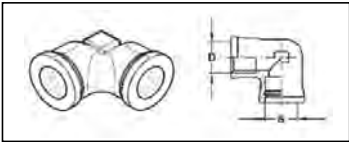

9 SWIVEL PLUG BARREL TEE

893 501 193 4	M12x1.5 Barrel Tee for P5 plug
893 501 194 4	M 16x1.5 Barrel Tee for P5 plug

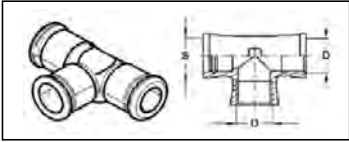

10 SWIVEL PLUG BRANCH TEE

893 501 195 4	M12x1.5 Branch Tee for P5 plug
893 501 196 4	M 16x1.5 Branch Tee for P5 plug

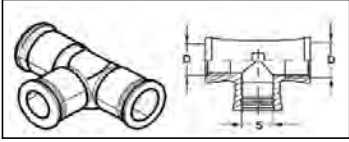

11 BULKHEAD UNIONS

ASA7098	M16 - 12mm *
ASA7169	M22 - 12mm * (Alternative: ASA7169)
ASA7099	M22 - 08mm *
ASA7123	M22 - 12mm * IM18 body
ASA7124	M22 - 08mm * IM18 body
	* WITH Lock nut, Thrust ring and O ring

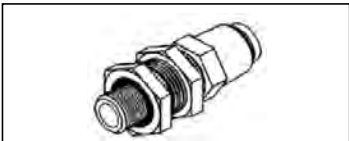

12 BULKHEAD ELBOWS

ASA7101	M22 - 12mm Swivel Type Short P5 plug (alternative: ASA7170)
ASA7102	M12 - 08mm * (Alternative: ASA7102)
ASA7103	M16 - 08mm Swivel Type Short P5 plug (Alternative: 893 831 293 0 *)
ASA7187	M22 - 15mm *
	* WITH Lock nut, Thrust ring and O ring



13 TEES

ASA7105	08-08-08
ASA7182	12-12-12 (Alternative: ASA7104)
ASA7106	15-15-15 (Alternative: ASA7183)
ASA7177	012-08-012
ASA7203	012-08-08



14 BRANCH TEES (ASSEMBLED)

ASA7107	012-M22-08 * (replaces: 8938510200)
ASA7109	012-M22-012 * (replaces 8938509700 and ASA7202)
ASA7164	08-M22-08 *
	* WITH Lock nut, Thrust ring and O ring



15 BARREL TEES (ASSEMBLED)

ASA7108	M22-012-08 * (replaces 8938510500)
ASA7110	M22-012-012 *
ASA7115	M12-08-08 * (replaces 8938510600)
	* WITH Lock nut, Thrust ring and O ring



16 TEST POINT TEES (ASSEMBLED)

ASA7111	M22 - TP - 08 *
ASA7112	M22 - TP - 012 *
ASA7113	M16 - TP - 012 *
ASA7114	M16 - TP - 08 *
ASA7097	M12 - TP - 08 *
	* WITH Lock nut, Thrust ring and O ring



17 LINE CONNECTORS

893 803 034 0	6mm-6mm
893 803 037 0	08mm - 08mm (replaces 4101064M)
893 803 039 0	12mm - 12mm (replaces 4101066M)
893 803 041 0	15mm - 15mm

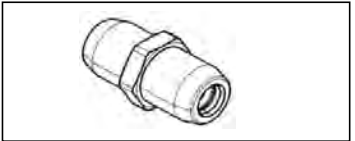

18 VEE NUTS

893 771 236 4	VEE Nut 6x1 Pipe M12
893 771 234 4	VEE Nut 8x1 Pipe M14
893 771 235 4	VEE Nut 12x1.5 Pipe M18



19 O-RINGS

897 071 110 4	M12
897 770 250 4	M16
897 080 400 4	M22



20 THRUST RINGS

893 030 070 4	M12
893 030 170 4	M16
893 030 040 4	M22



21 VARIOUS

891 503 076 2	Locknut with O ring M22
891 500 454 4	Locknut withOUT O ring M22



4101058M	M16 M Test point (alternative 4637031140)
4101057M	M12 M Test point (replaces 4637020030)



893 022 014 4	M16 M Plug with Oring (alternative 4101061F)
893 022 015 4	M22 M Plug with Oring (alternative 4087057F)



A6735	3/8" - 1/2" Hose Tail
4087055F	M16 - 1/2" Hose Tail with Oring (alternative 8931294452)
4087063F	M22 - 1/2" Hose Tail with Oring (alternative 8931294462)
ASA7127	M16M - 1/2"hose - 1/2" hose



893 104 058 4	M22 Bulkhead Stud ID M16 (alternative 4100992M)
	(No Locknut)



899 360 210 4	Thread Filter M 12x1.5
899 360 260 4	Thread Filter M 16x1.5
899 360 140 4	Thread Filter M 22x1.5



4101163M	M18 - M16 Socket
A6717	M16 - 1/2" Socket

